

eko okna



KATALOG TECHNICZNY PVC



CATALOGUE TECHNIQUE PVC



PVC TECHNICAL CATALOGUE



TECHNISCHER KATALOG PVC



CATALOGO TECNICO PVC



1/2020

2019
2019



IDEAL 4000

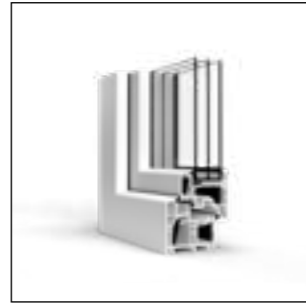

ENERGETO 8000



EASY SLIDE ST 60



STREAMLIN 76



EKOSUN 70



S 9000



IDEAL 4000 NEW



BLOCKPROFIL



MULTI SLIDE ST 80



BLUEEVOLUTION 82

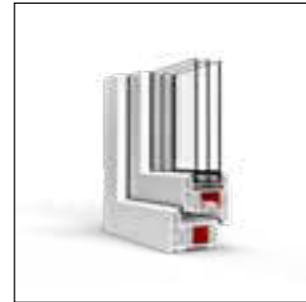

EKOSUN 6



HST GEALAN



IDEAL 5000



MONOBLOCK



SMART SLIDE



BLUEEVOLUTION 92



EKOSUN 7



IDEAL 7000 NEW



NORDLINE



HST 70



EVOLUTIONDRIVE SF



HST EKOSUN



IDEAL 8000



IDEAL 70 / CASEMENET



HST 85



EVOLUTIONDRIVE 82

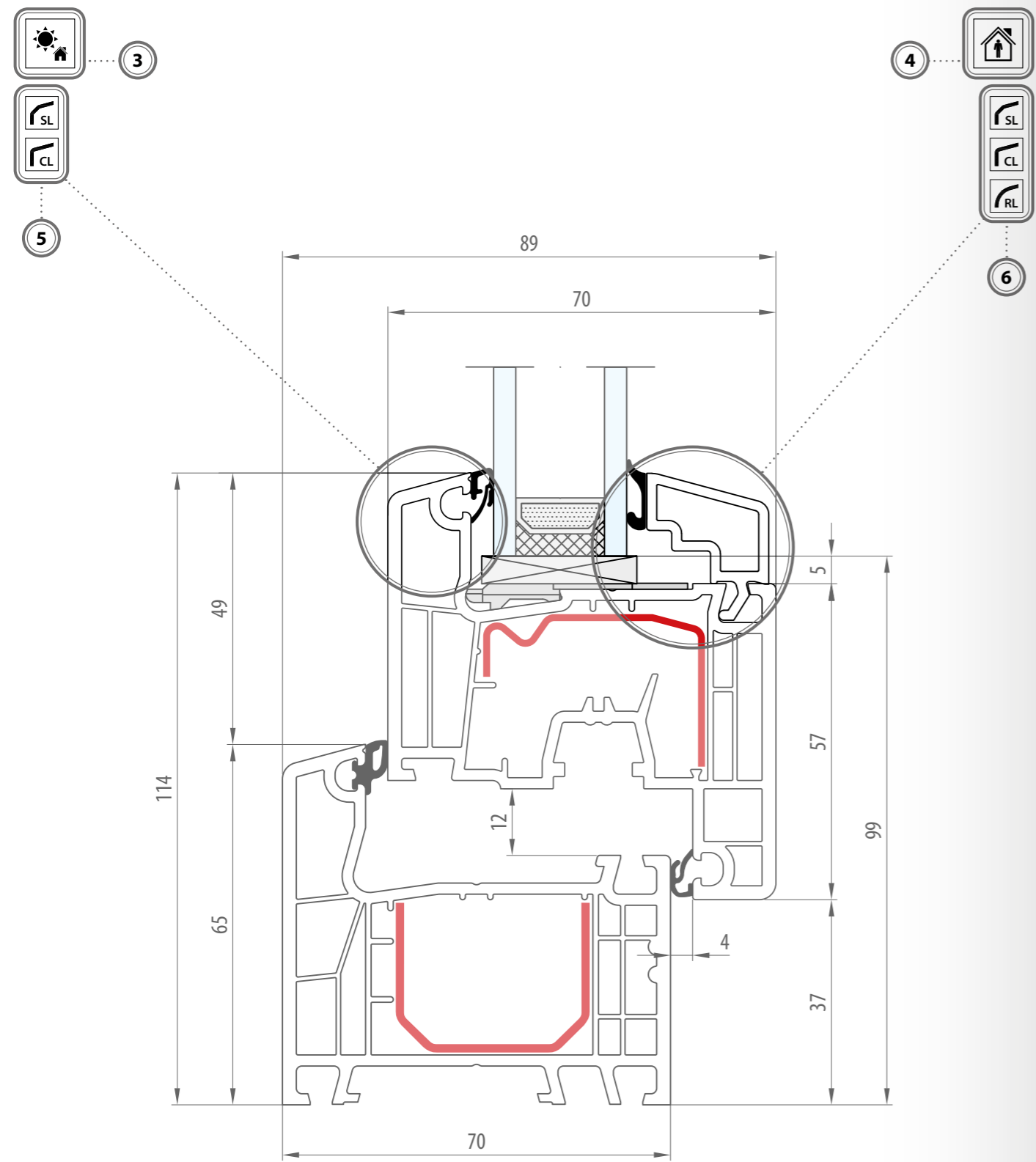

- 1 Rama: 65 mm · Skrzydło: 77 mm
- 2 Dormant: 65 mm · Vantail: 77 mm
- 3 Frame: 65 mm · Sash: 77 mm
- 4 Rahmen: 65 mm · Flügel: 77 mm
- 5 Telaio: 65 mm · Anta: 77 mm

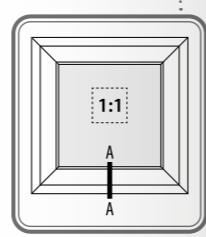

Opis oznaczeń · Description des marquages · Descriptions of markings
Beschreibung · Descrizione delle marcature

- 1 Nazwa systemu
Nom du système
Name of a system
System
Nome del sistema
- 2 Numery profili
Numéros de profil
Number of profiles
Nummern der Profile
Numeri dei profili
- 3 Strona zewnętrzna
Face extérieure
External side
Aussensseite
Parte esterna
- 4 Strona wewnętrzna
Face intérieure
Internal side
Innenseite
Parte interna
- 5 Wykończenie zewnętrzne skrzydła
Finition extérieure des l'ouvrant
Finished of an external sash
Ausführung der Innenseite es Flügels
Finitura esterna dell'anta
- 6 Wykończenie listwy przyszybowej
Finition de la parclose
Finished of a glazing bead
Ausführung der Glasleiste
Finitura del fermavetro
- 7 Opis rysunku - szerokość profili
Description du dessin
Description of a drawing
Beschreibung der Zeichnung
Descrizione del disegno
- 8 Miejsce i skala przekroju
Endroit et échelle de la coupe
Place and scale of the cross-section
Stelle und Skala des Querschnitts
Luogo e scala della sezione

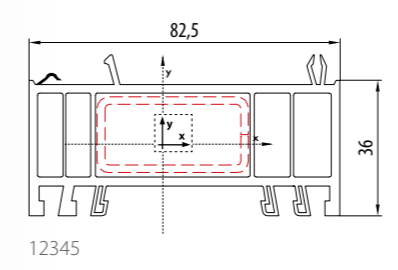

	0,0	-	lx 0,0	ly 0,0
	2,0	12345	lx 1,4	ly 4,1
Wzmocnienie	Grubość	Kod	Moment bezwładności [cm ⁴]	
Renforcement	Épaisseur	Code	Moment d'inertie [cm ⁴]	
Reinforcement	Thickness	Code	Moment of inertia [cm ⁴]	
Verstärkung	Stärke	Code	Flächenträgheitsmoment [cm ⁴]	
Rinforzo	Spessore	Codice	Momento di inerzia [cm ⁴]	

Przedstawiono wzmocnienia standardowe dla konstrukcji w kolorze białym o wymiarach referencyjnych.

Les renforts standard pour une structure de couleur blanche de dimension de référence ont été présentés.

Standard reinforcements for white constructions with reference dimensions are presented

Es wurden standard Verstärkungen bei weißen Elementen mit Referenzmassen dargestellt

Sono stati presentati i rinforzi standard delle costruzioni di colore bianco con dimensioni di riferimento.

Opis oznaczeń · Description des marquages · Descriptions of markings
Beschreibung · Descrizione delle marcature



- Ilość komór
- Nombre de chambres
- Number of chambers
- Anzahl Kammern
- Quantità di camere



- Ilość uszczeltek
- Nombre de jointns
- Number of gaskets
- Anzahl Dichtungen
- Quantità delle guarnizioni



- Głębokość zabudowy
- Profondeur de construction
- Installation depth
- Bautiefe
- Profondità di montaggio



- Max grubość wypełnienia
- Épaisseur max du vitrage
- Max filing thickness
- Maximale Stärke der Verglasung
- Massimo spessore del riempimento



- Strona zewnętrzna
- Face extérieure
- External side
- Aussensetie
- Parte esterna



- Strona wewnętrzna
- Face intérieure
- Internal side
- Innenseite
- Parte interna



- Rodzaj zgrzewu
- Type de soudure
- Welding type
- Art der Schweißnaht
- Tipo di saldatura



- Możliwość zamówienia profilu w klasie A
- Possibilité de commander le profilé de classe A
- It is possible to order a profile in A class
- Auch als A-Klasse-Profil erhältlich
- Possibilità di ordinare il profilo di classe A



- Okucie okienne
- Ferrage de fenêtre
- Window fitting
- Fenster-Beschlag
- Ferramenta di finestre



- Okucie drzwiowe
- Ferrage de porte
- Door fitting
- Tür-Beschlag
- Ferramenta di porte



- Technologia szyby wklejanej
- Technologie de vitrage collé
- Bonded glass technology
- Glas verklebt
- Tecnologia del vetro incollato



- Nakładki aluminiowe
- Capotage aluminium
- Aluminium covers
- Aluschale
- Coperture in alluminio



Soft-line



Round-line



Classic-line



History-line

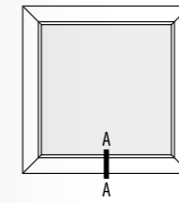

- Okno ze stałym szkleniem
- Fenêtre fixe
- Window with a fixed glazing
- Festverglasung
- Finestre fisse

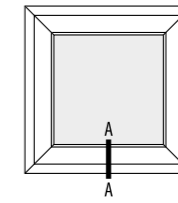

- Rama - skrzydło
- Dormant - Ouvrant
- Frame - Sash
- Rahmen - Flügel
- Telaio - Anta

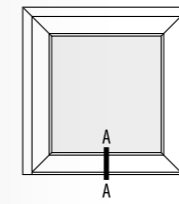

- Próg - skrzydło
- Seuil - Ouvrant
- Threshold - Sash
- Schwelle - Flügel
- Soglia - Anta

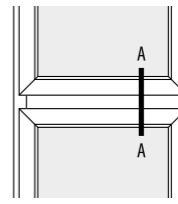

- Poprzeczka
- Traverse
- Muntin bar
- Kämpfer
- Traverso

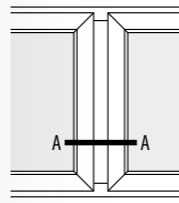

- Słupek stały
- Meneau fixe
- Fixed post
- Fester Pfosten
- Montante fisso

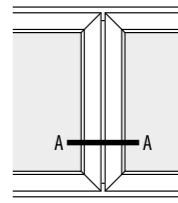

- Słupek ruchomy
- Meneau mobile
- Moveable post
- Stulp
- Montante mobile

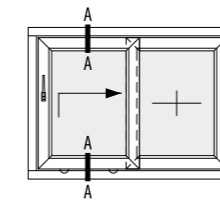
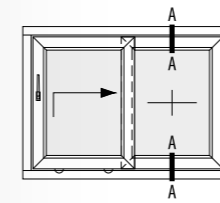

- Schemat A - przekrój pionowy
- Schéma A - coupe verticale
- Schema A - vertical intersection
- Schema A - Senkrechter Querschnitt
- Schema A - intersezione verticale

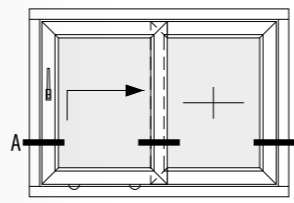

- Schemat A - przekrój poziomy
- Schéma A - coupe horizontale
- Schema A - horizontal intersection
- Schema A - Waagerechter Querschnitt
- Schema A - intersezione orizzontale





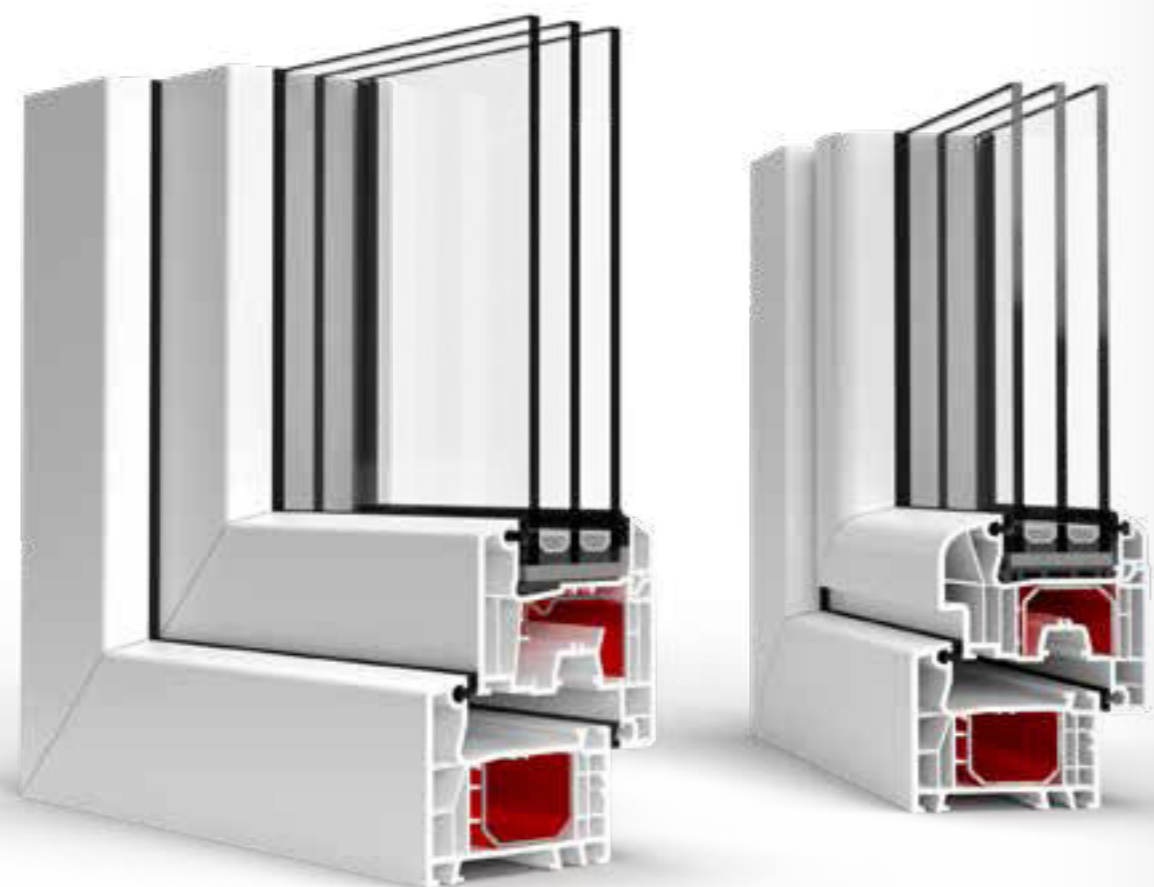

aluplast®

Kunststoff-Fenstersysteme

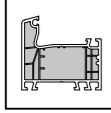
IDEAL 4000

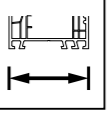
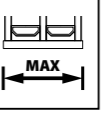
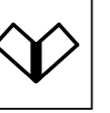
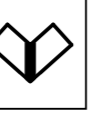

- 
5
- 
2
- 
70
- 
42
- 
V-SUPER
- 
V-PERFECT
- 
ALU



IDEAL 4000 +
 IDEAL 5000 NEW
 IDEAL 5000
 IDEAL 7000 NEW
 IDEAL 7000 NEW
 IDEAL 8000
 ENERGETO 8000

IDEAL 4000 +
 IDEAL 4000 NEW
 IDEAL 5000
 IDEAL 7000 NEW
 IDEAL 7000 NEW
 IDEAL 8000
 ENERGETO 8000

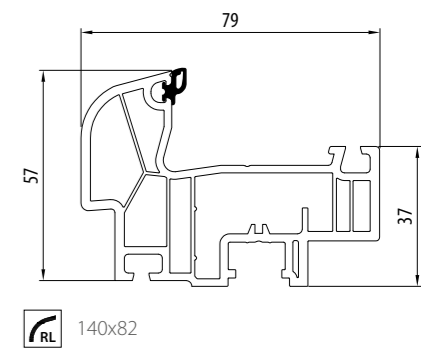
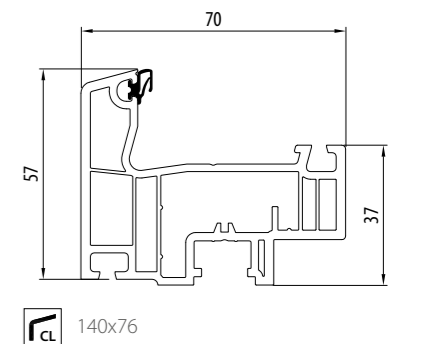
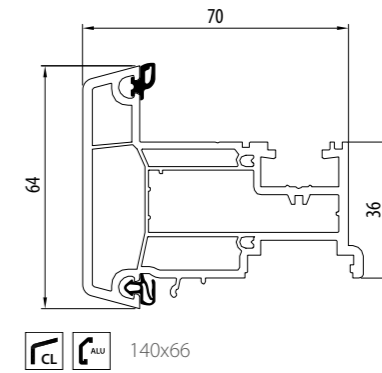
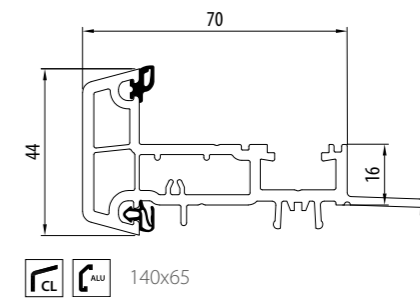
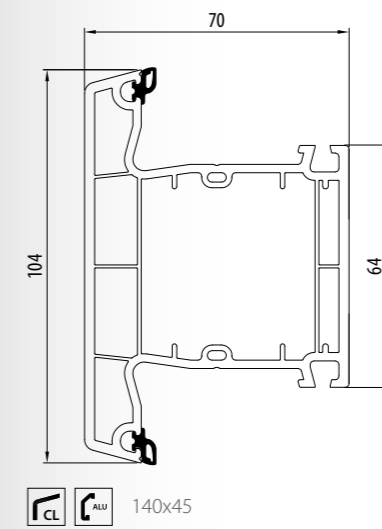
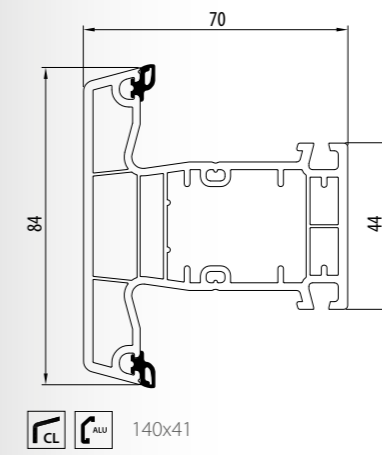
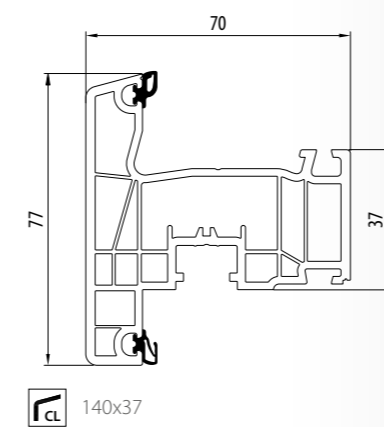
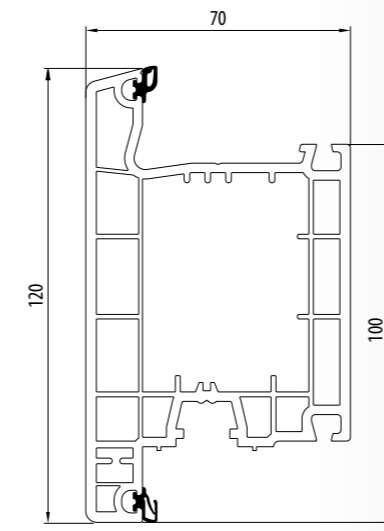
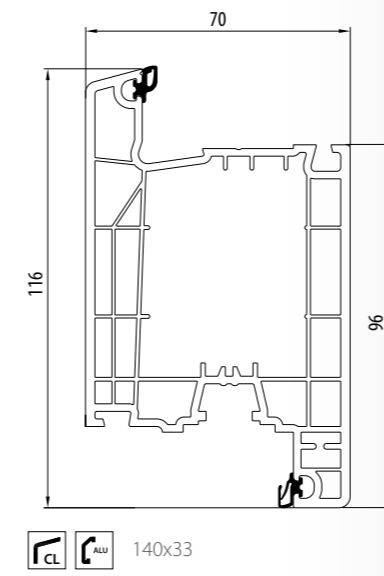
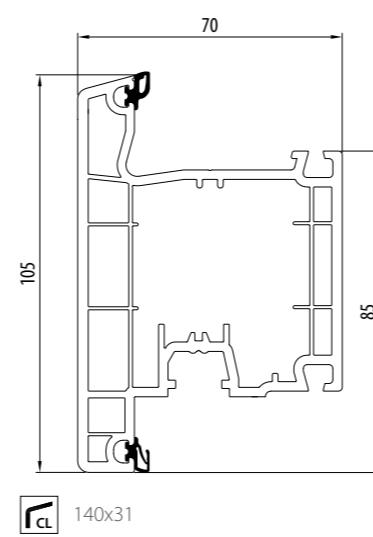
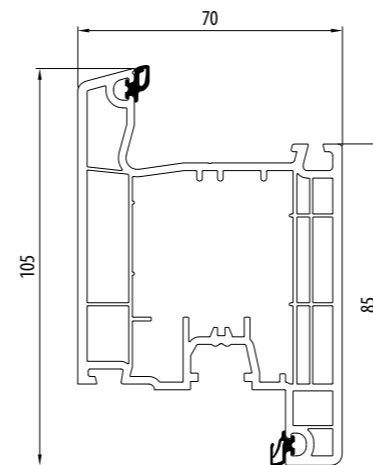
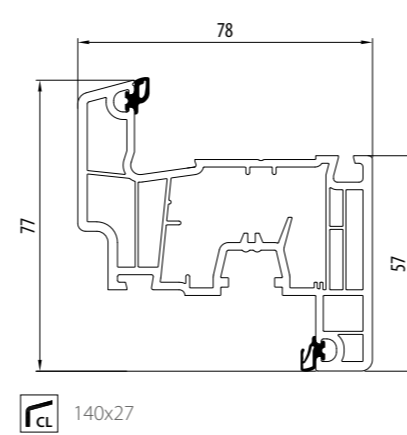
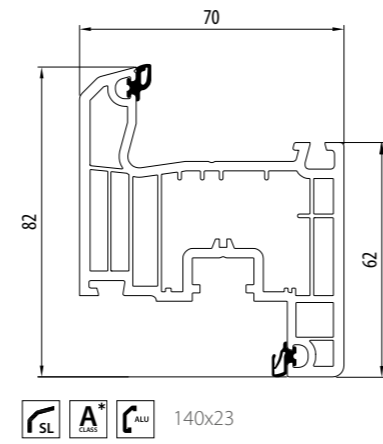
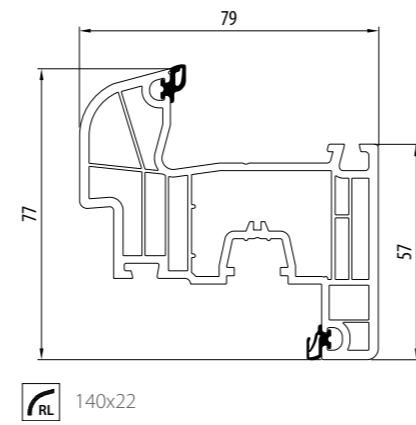
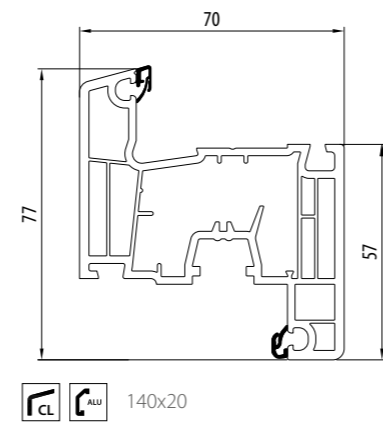
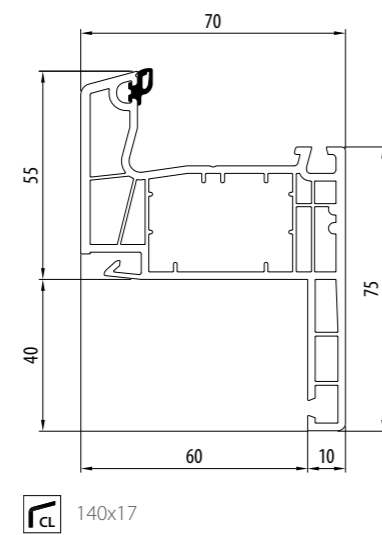
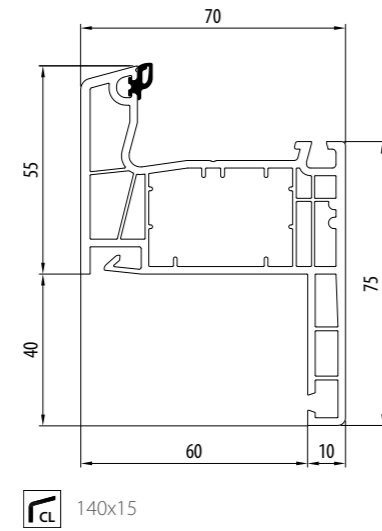
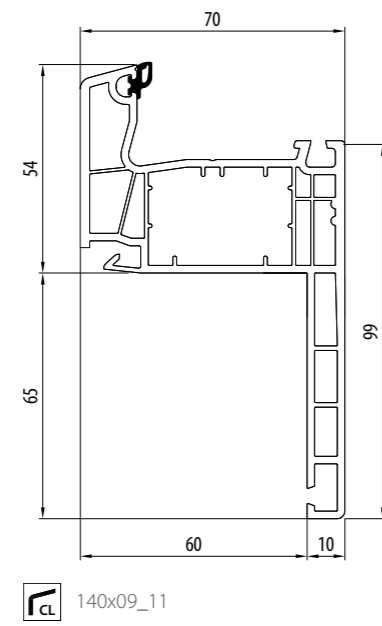
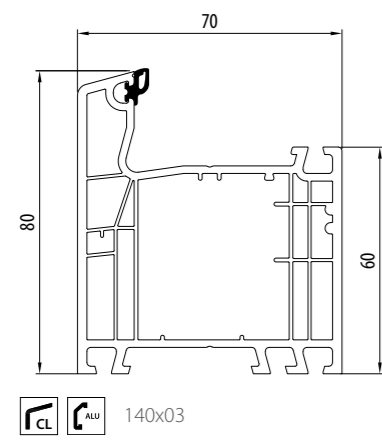
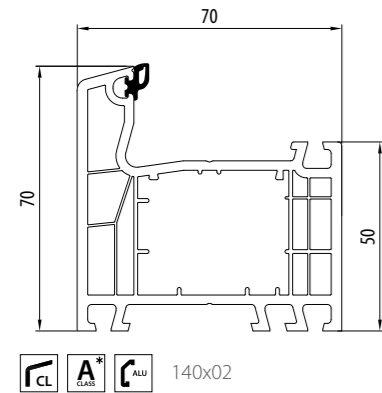
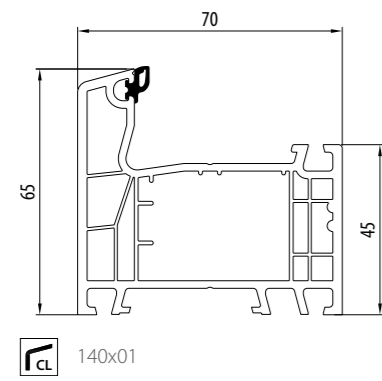

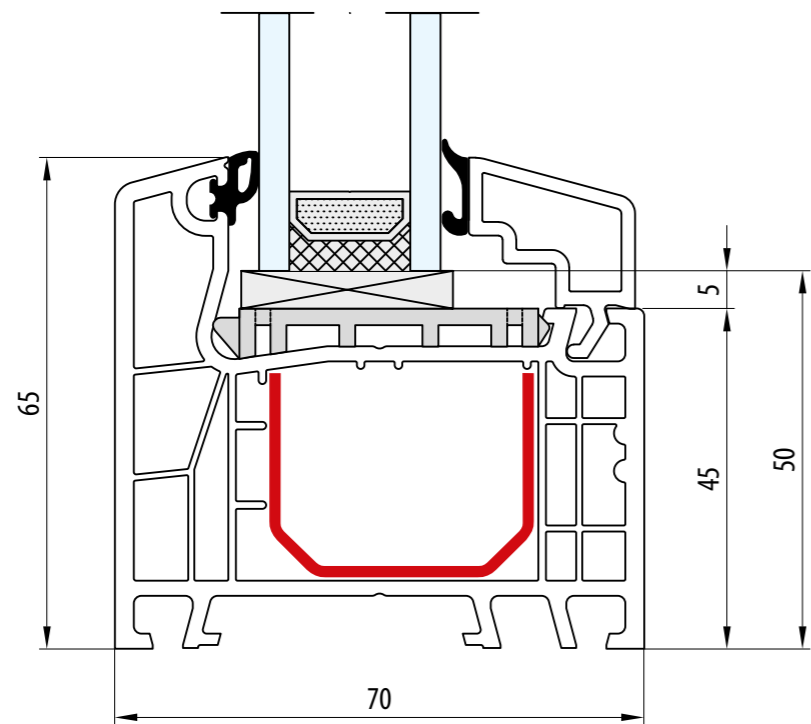

- Rama: 65 mm
- Dormant: 65 mm
- Frame: 65 mm
- Rahmen: 65 mm
- Telaio: 65 mm

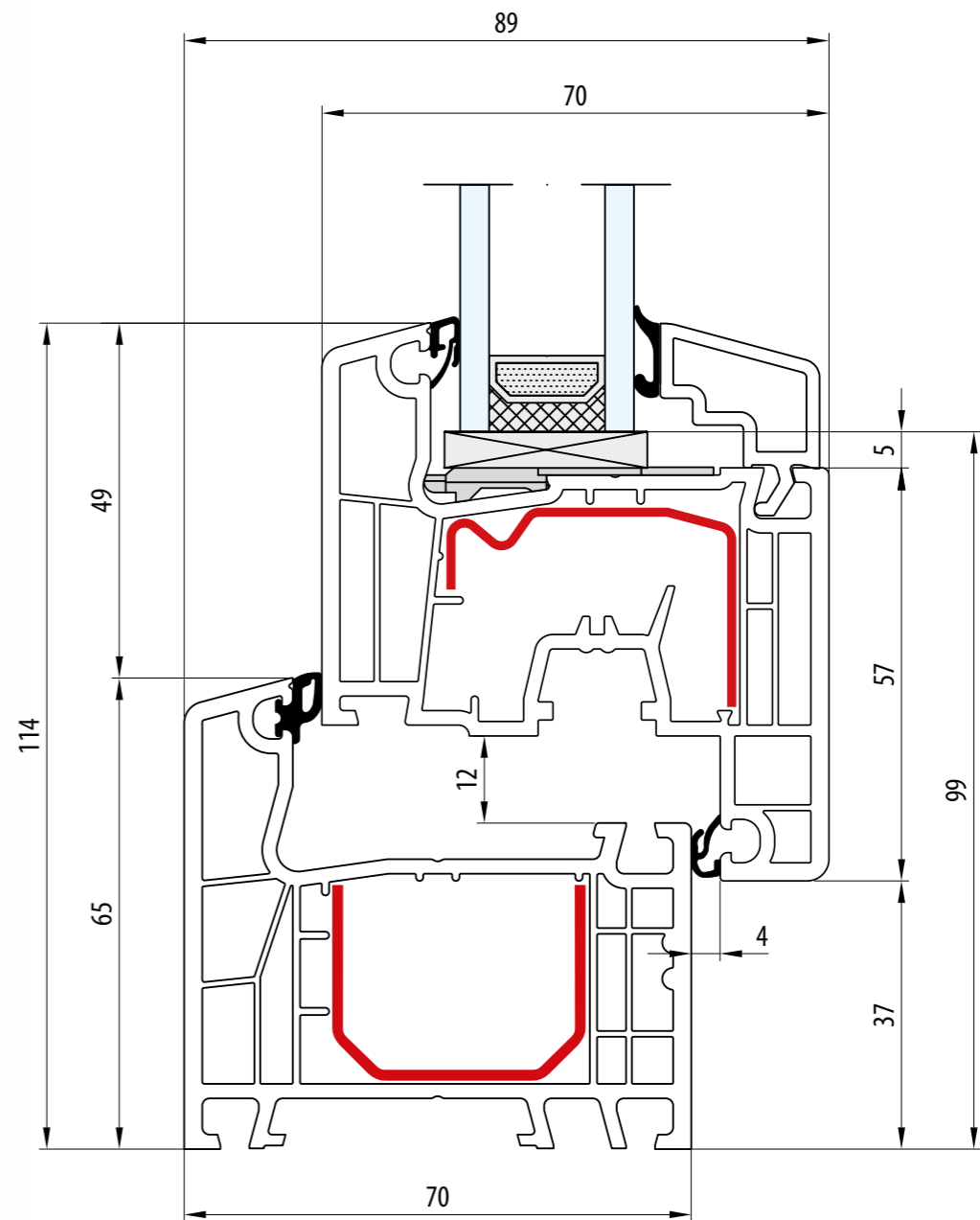
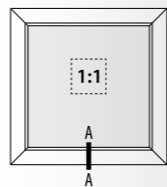

- Rama: 65 mm · Skrzydło: 77 mm
- Dormant: 65 mm · Vantail: 77 mm
- Frame: 65 mm · Sash: 77 mm
- Rahmen: 65 mm · Flügel: 77 mm
- Telaio: 65 mm · Anta: 77 mm

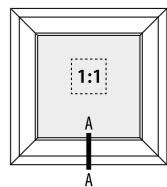

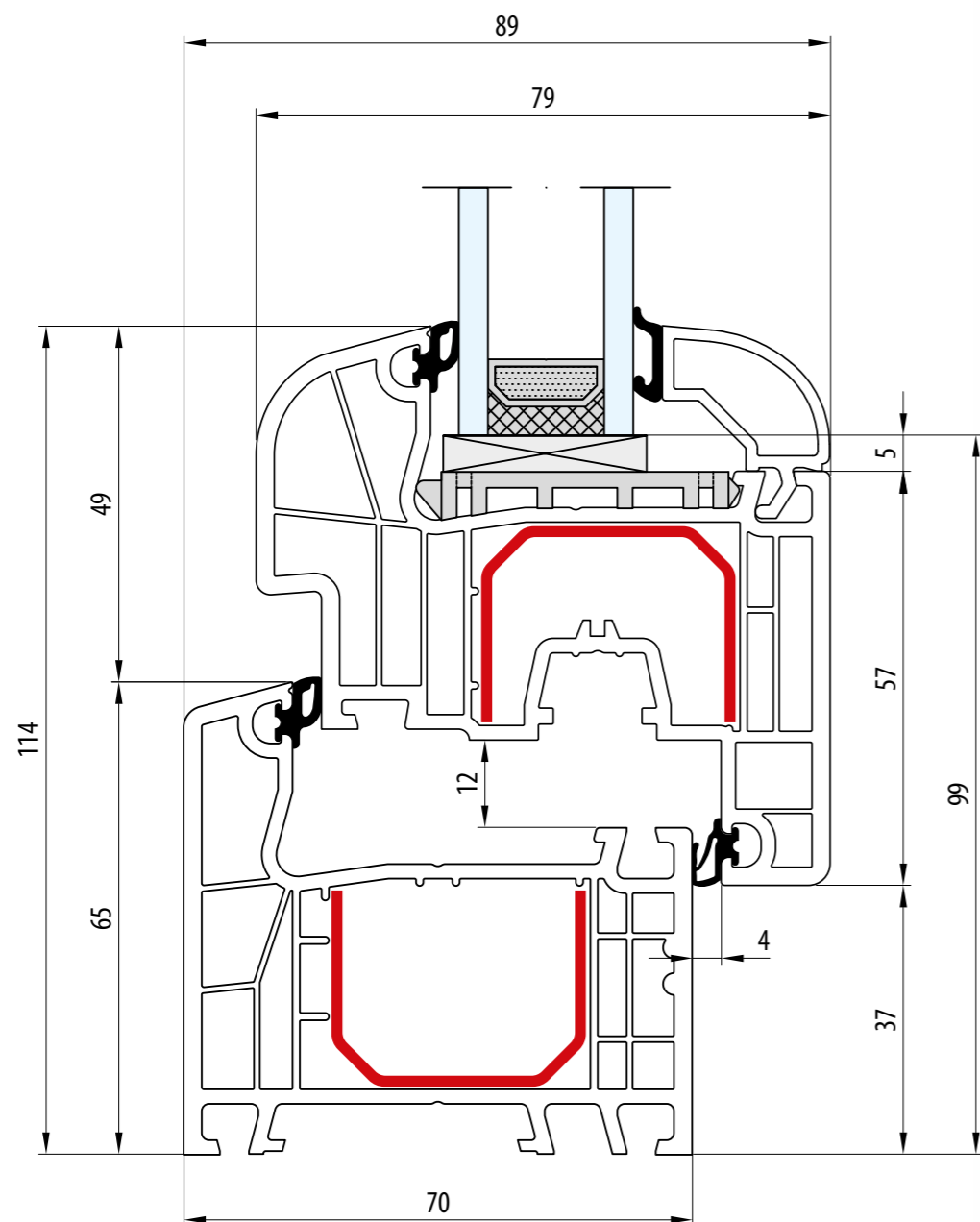

- Rama: 65 mm · Skrzydło: 77 mm
- Dormant: 65 mm · Vantail: 77 mm
- Frame: 65 mm · Sash: 77 mm
- Rahmen: 65 mm · Flügel: 77 mm
- Telaio: 65 mm · Anta: 77 mm

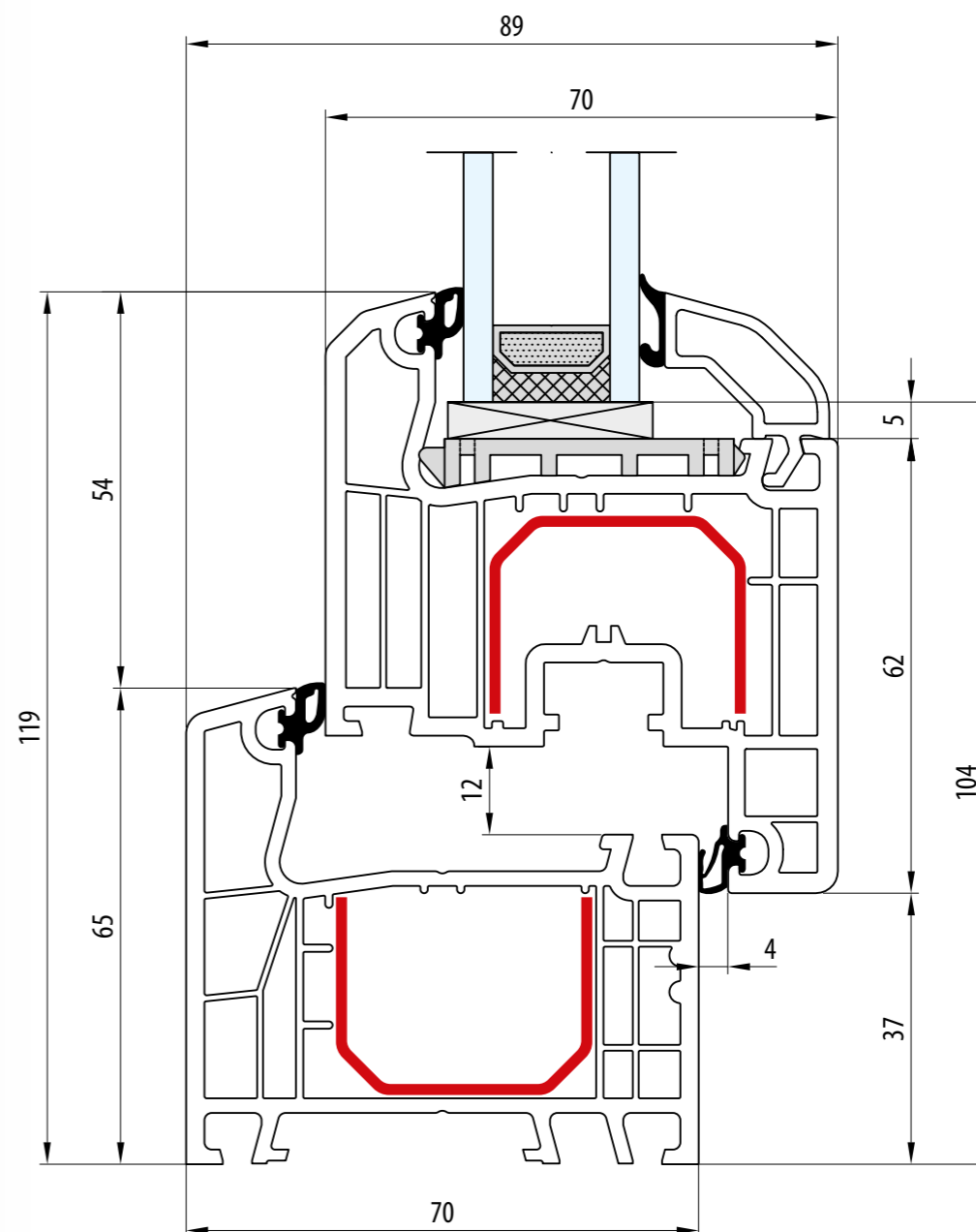
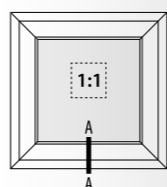

- Rama: 65 mm · Skrzydło: 82 mm
- Dormant: 65 mm · Vantail: 82 mm
- Frame: 65 mm · Sash: 82 mm
- Rahmen: 65 mm · Flügel: 82 mm
- Telaio: 65 mm · Anta: 82 mm

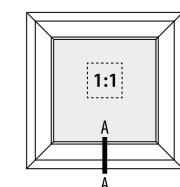

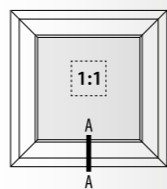
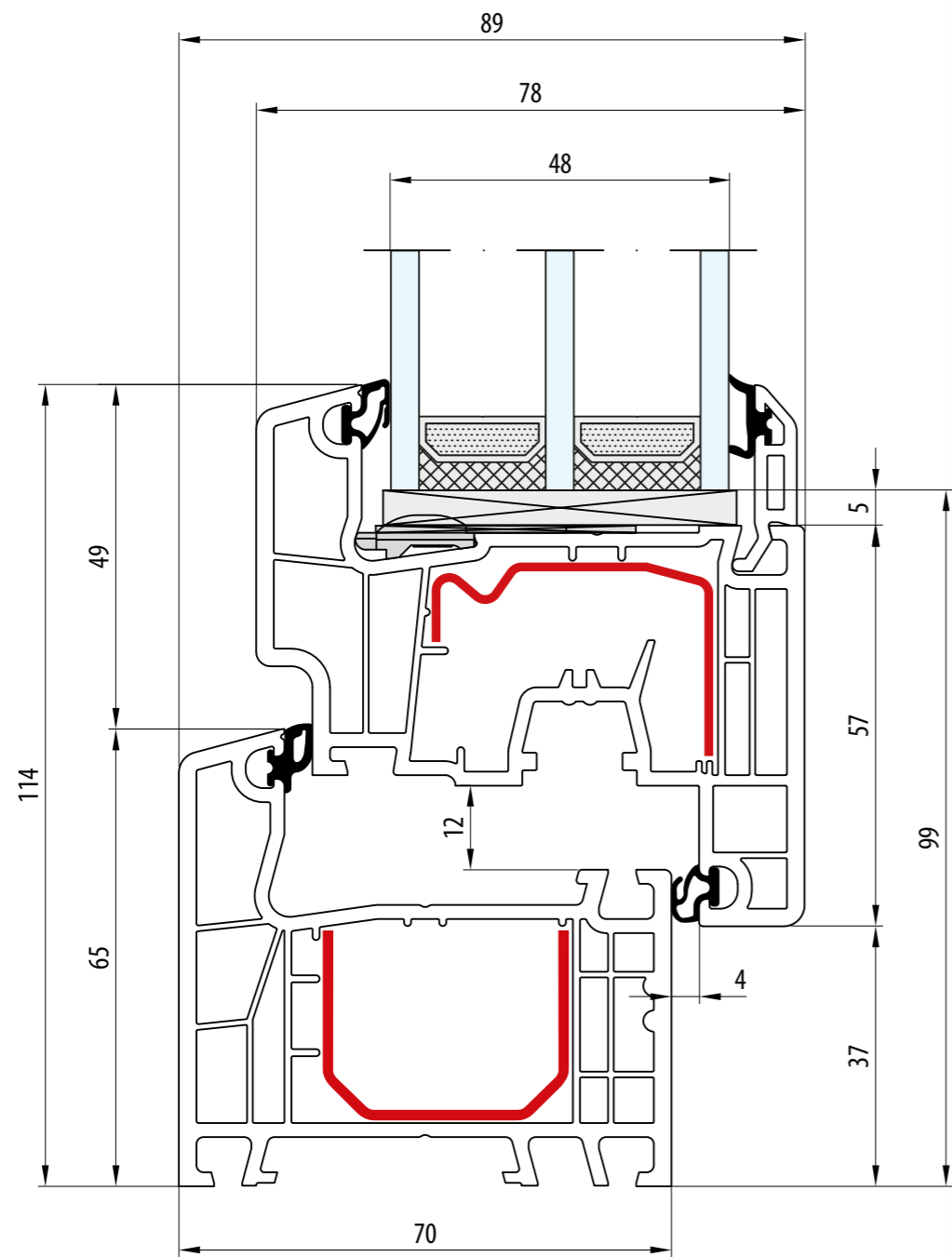

- Rama: 65 mm · Skrzydło: 77 mm
- Dormant: 65 mm · Vantail: 77 mm
- Frame: 65 mm · Sash: 77 mm
- Rahmen: 65 mm · Flügel: 77 mm
- Telaio: 65 mm · Anta: 77 mm

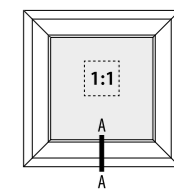
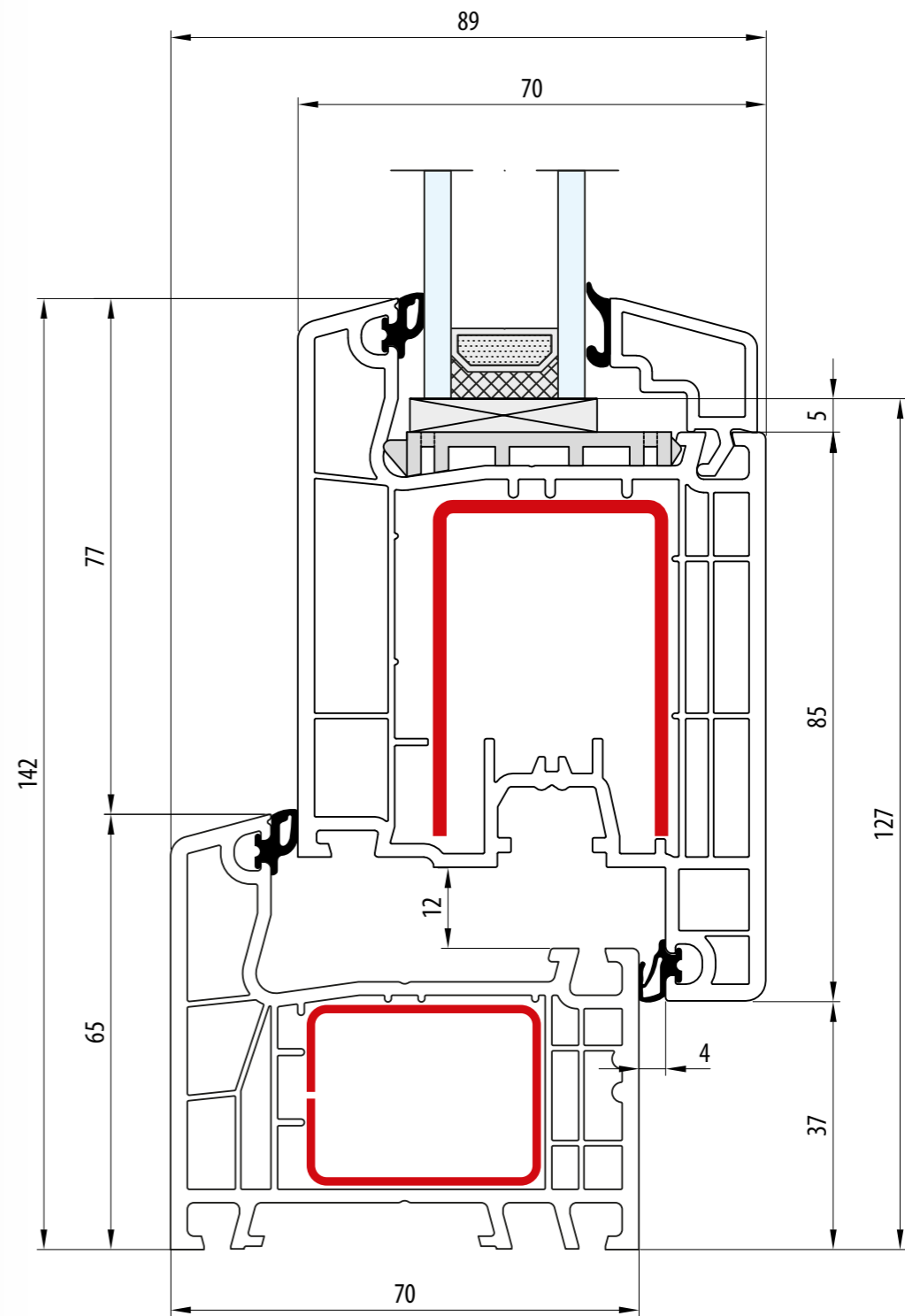

- Rama: 65 mm · Skrzydło: 105 mm
- Dormant: 65 mm · Vantail: 105 mm
- Frame: 65 mm · Sash: 105 mm
- Rahmen: 65 mm · Flügel: 105 mm
- Telaio: 65 mm · Anta: 105 mm

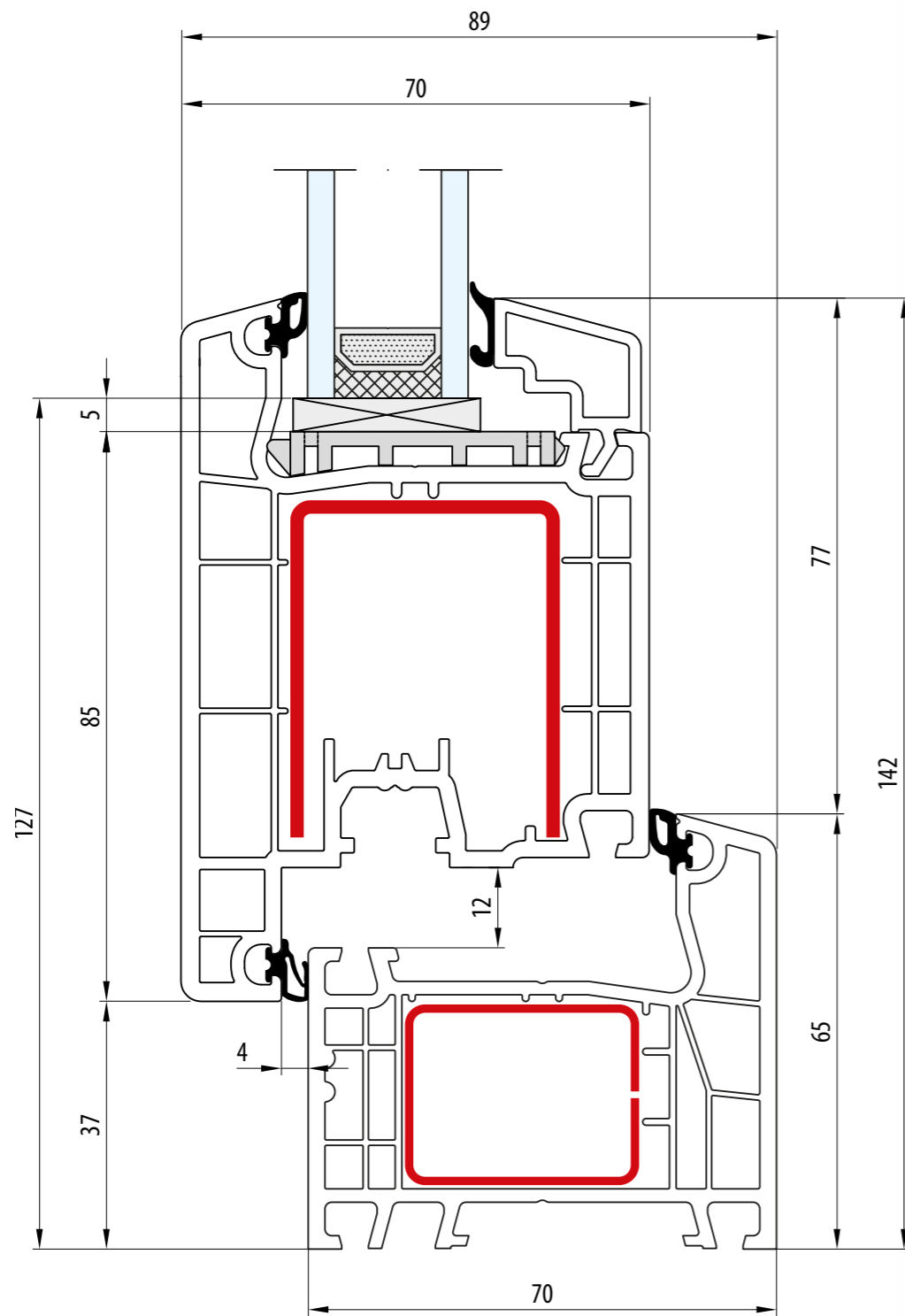

- Rama: 65 mm · Skrzydło: 105 mm
- Dormant: 65 mm · Vantail: 105 mm
- Frame: 65 mm · Sash: 105 mm
- Rahmen: 65 mm · Flügel: 105 mm
- Telaio: 65 mm · Anta: 105 mm

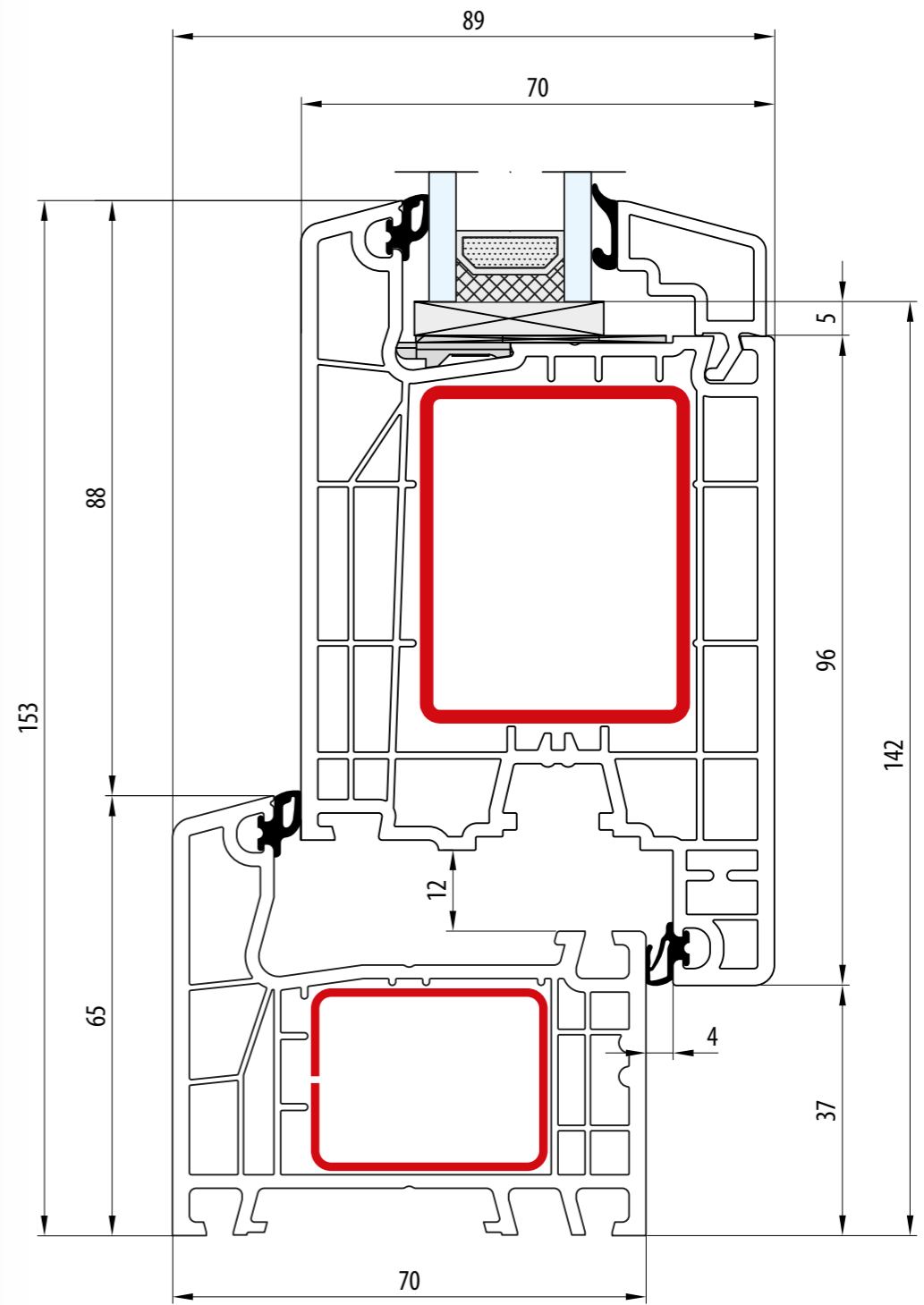
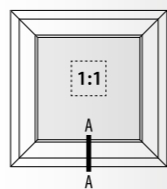

- Rama: 65 mm · Skrzydło: 116 mm
- Dormant: 65 mm · Vantail: 116 mm
- Frame: 65 mm · Sash: 116 mm
- Rahmen: 65 mm · Flügel: 116 mm
- Telaio: 65 mm · Anta: 116 mm

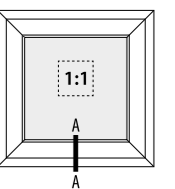

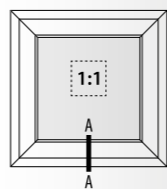
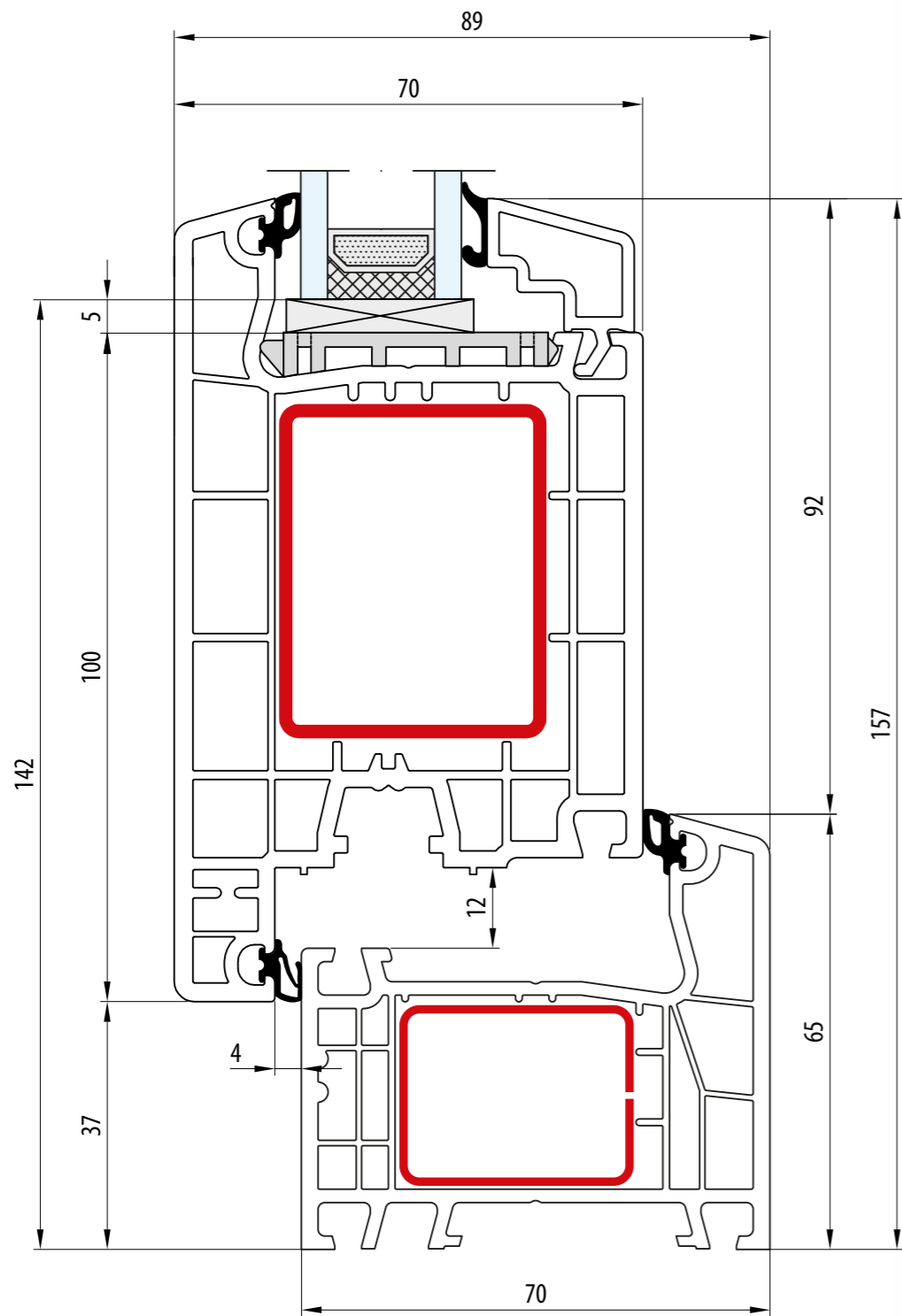

- Rama: 65 mm · Skrzydło: 120 mm
- Dormant: 65 mm · Vantail: 120 mm
- Frame: 65 mm · Sash: 120 mm
- Rahmen: 65 mm · Flügel: 120 mm
- Telaio: 65 mm · Anta: 120 mm

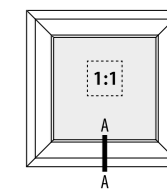
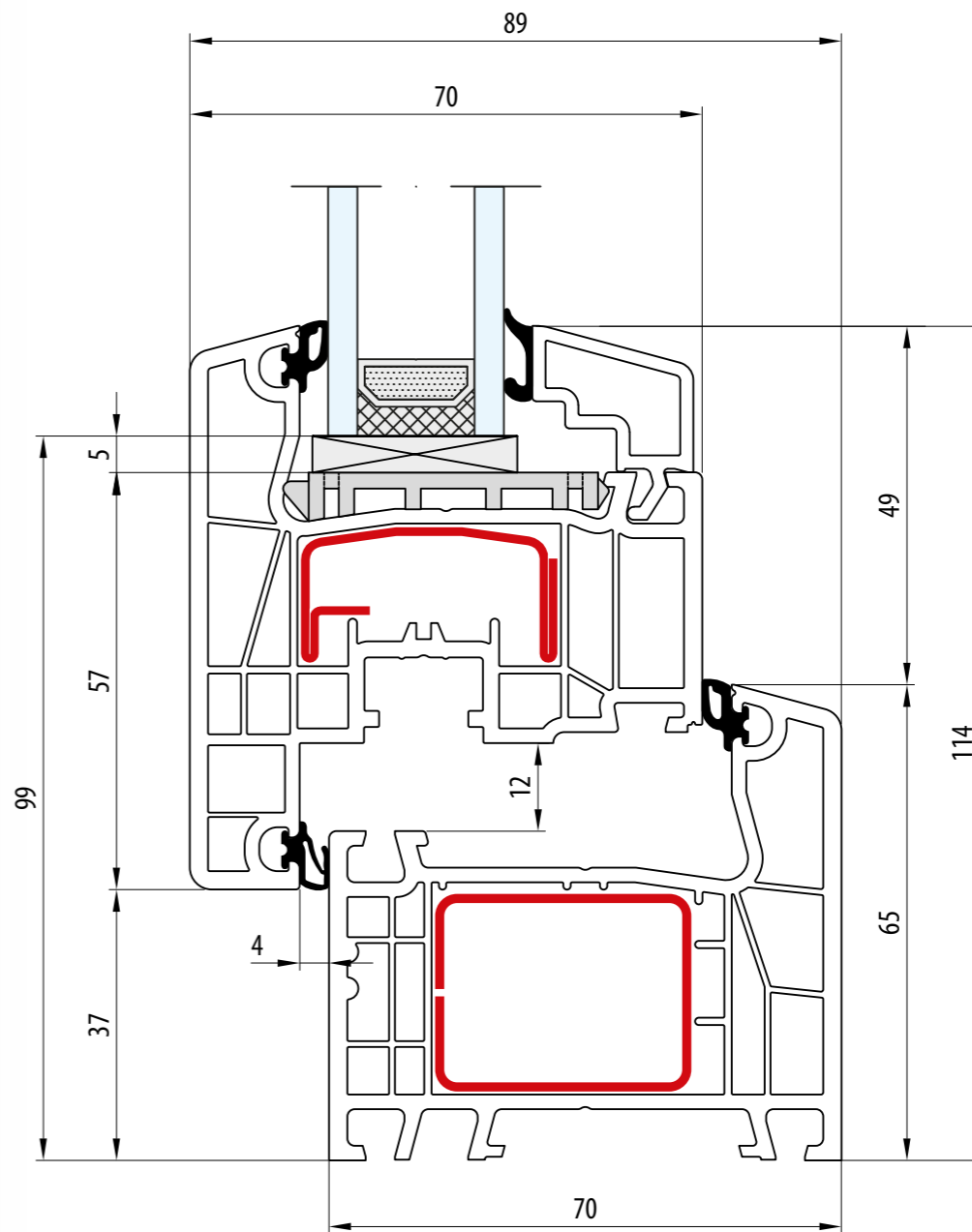

- Rama: 65 mm · Skrzydło: 77 mm
- Dormant: 65 mm · Vantail: 77 mm
- Frame: 65 mm · Sash: 77 mm
- Rahmen: 65 mm · Flügel: 77 mm
- Telaio: 65 mm · Anta: 77 mm

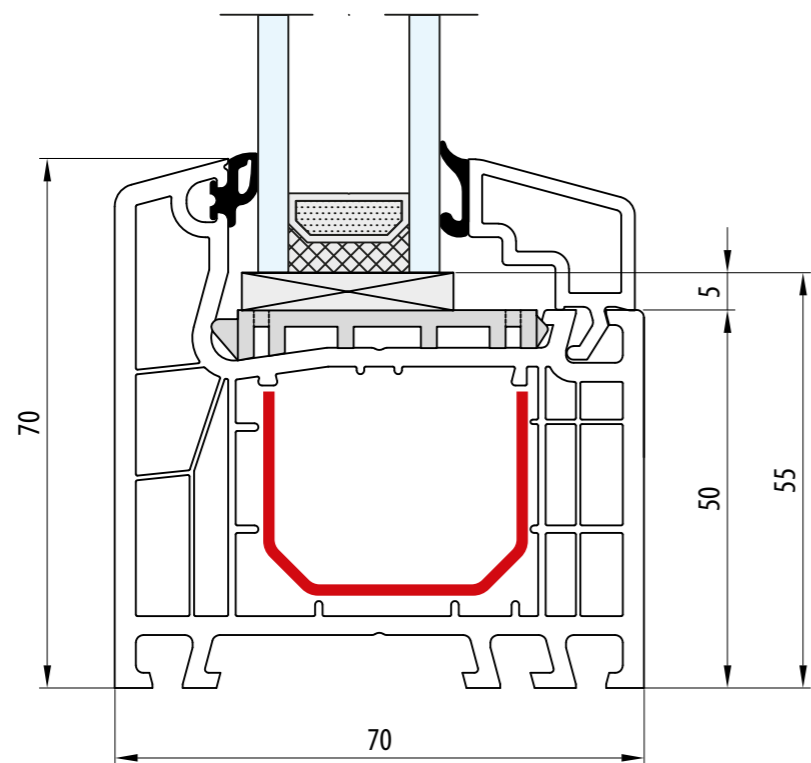

- Rama: 70 mm
- Dormant: 70 mm
- Frame: 70 mm
- Rahmen: 70 mm
- Telaio: 70 mm

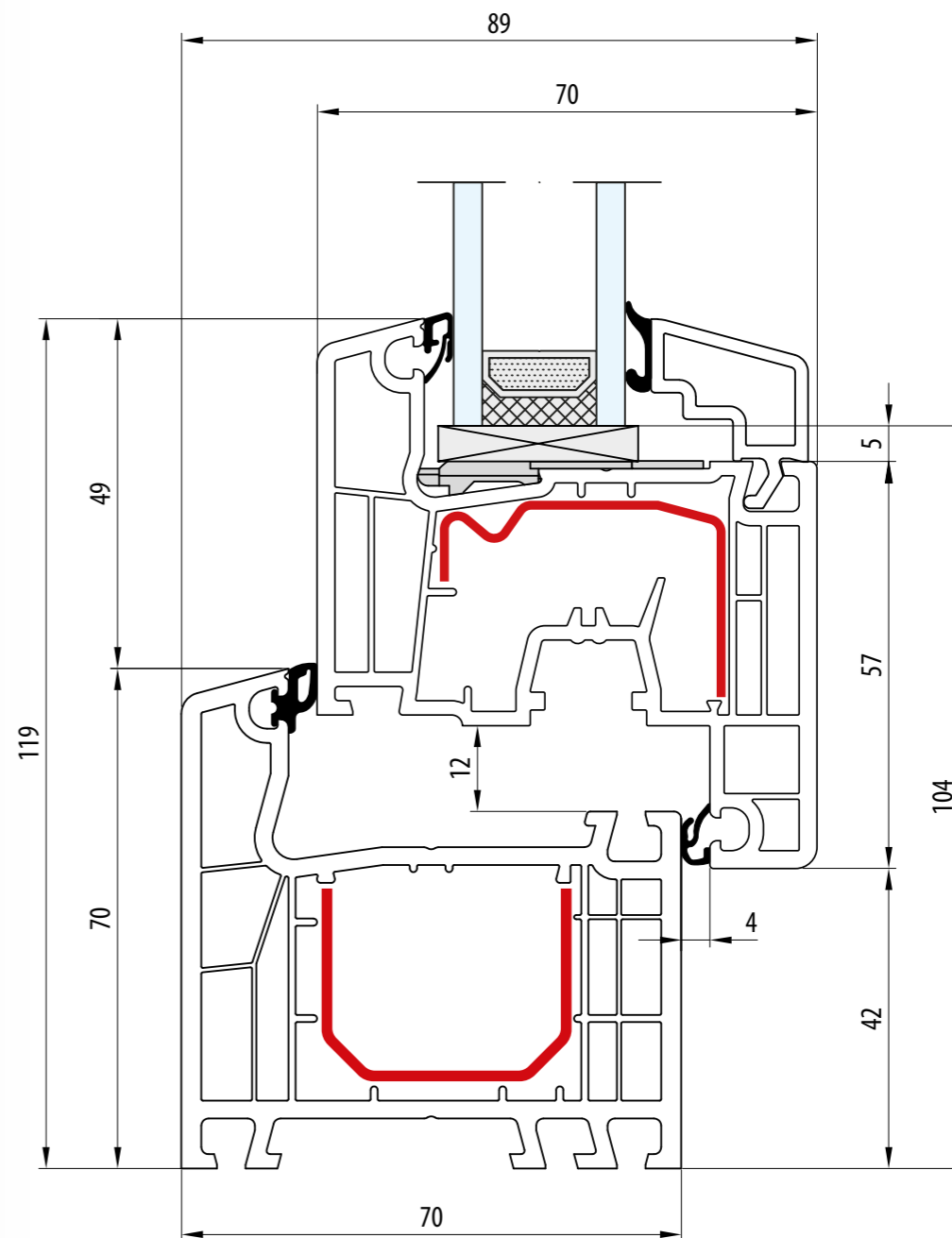
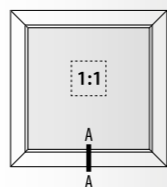

- Rama: 70 mm · Skrzydło: 77 mm
- Dormant: 70 mm · Vantail: 77 mm
- Frame: 70 mm · Sash: 77 mm
- Rahmen: 70 mm · Flügel: 77 mm
- Telaio: 70 mm · Anta: 77 mm

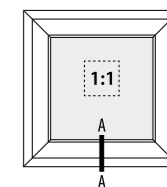

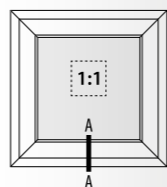
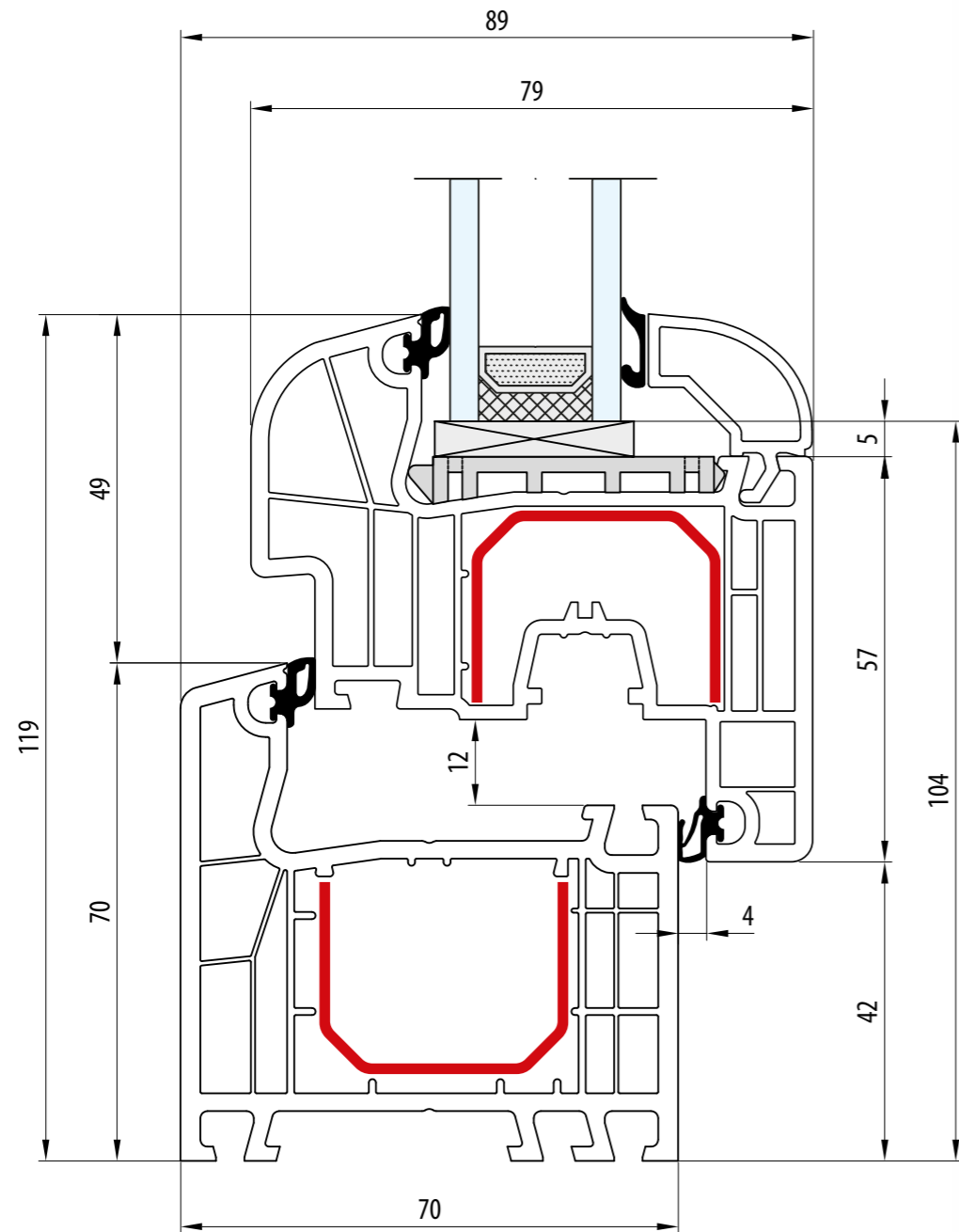

- Rama: 70 mm · Skrzydło: 77 mm
- Dormant: 70 mm · Vantail: 77 mm
- Frame: 70 mm · Sash: 77 mm
- Rahmen: 70 mm · Flügel: 77 mm
- Telaio: 70 mm · Anta: 77 mm

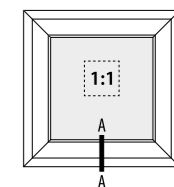
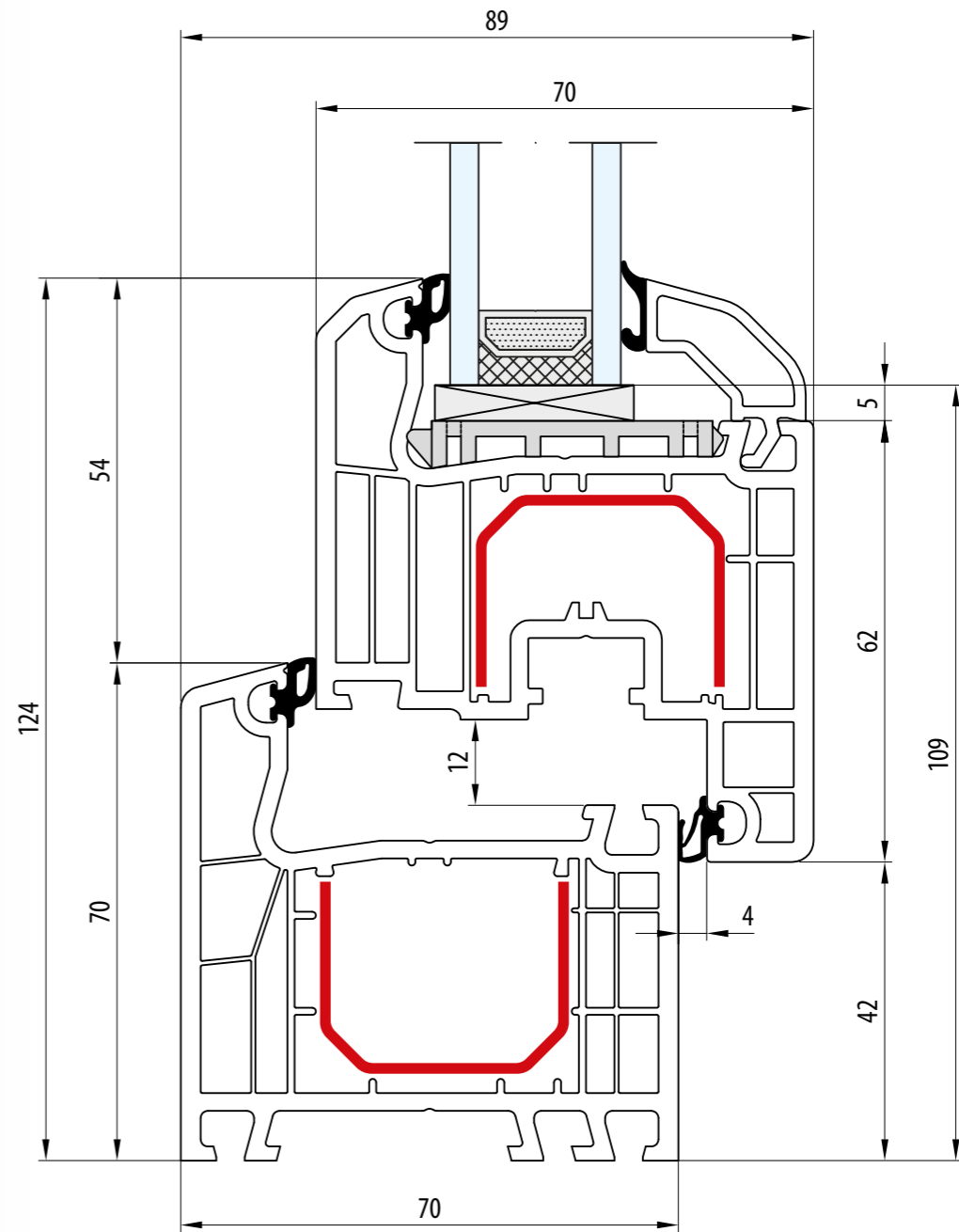

- Rama: 70 mm · Skrzydło: 82 mm
- Dormant: 70 mm · Vantail: 82 mm
- Frame: 70 mm · Sash: 82 mm
- Rahmen: 70 mm · Flügel: 82 mm
- Telaio: 70 mm · Anta: 82 mm

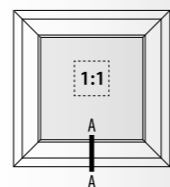
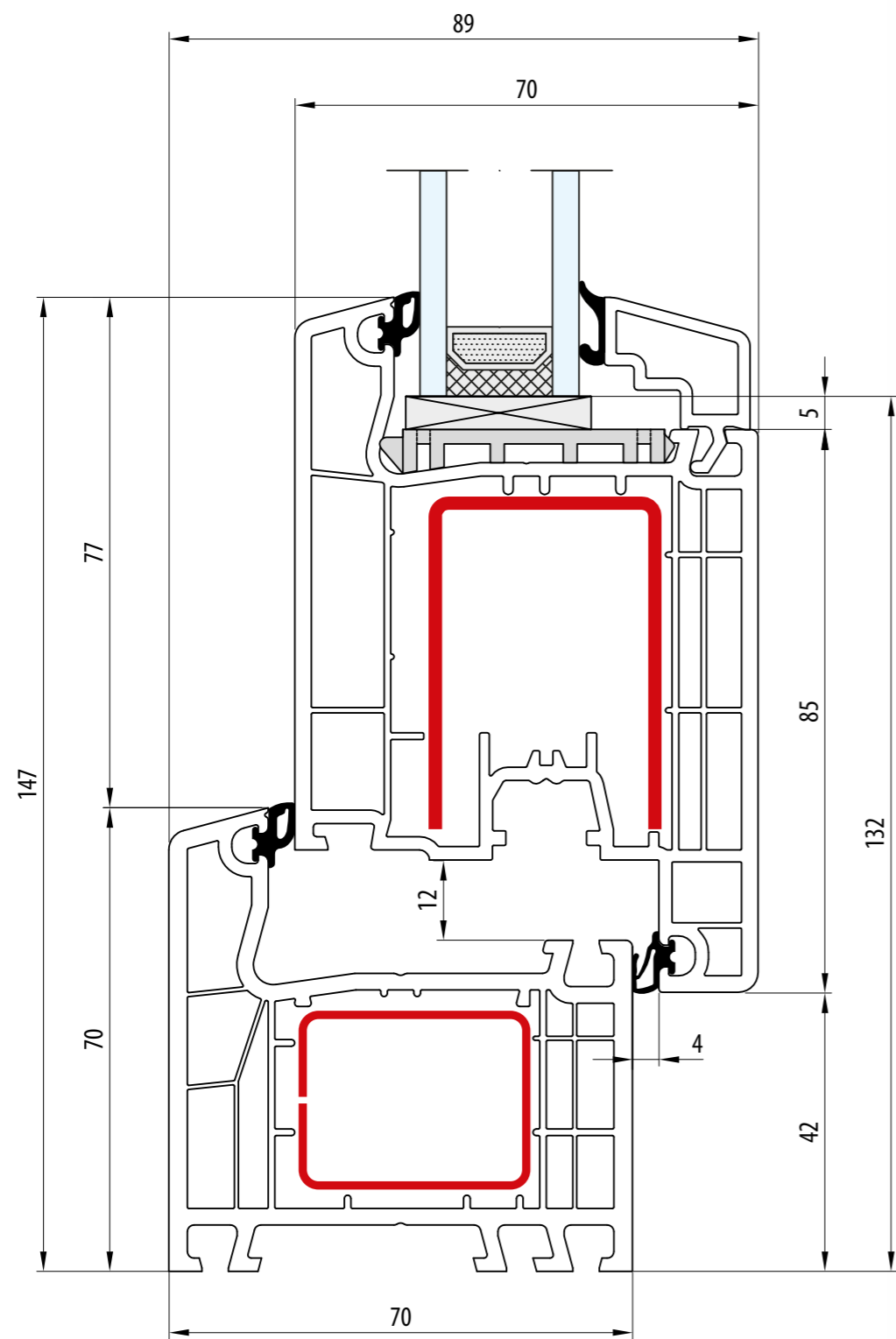

- Rama: 70 mm · Skrzydło: 105 mm
- Dormant: 70 mm · Vantail: 105 mm
- Frame: 70 mm · Sash: 105 mm
- Rahmen: 70 mm · Flügel: 105 mm
- Telaio: 70 mm · Anta: 105 mm

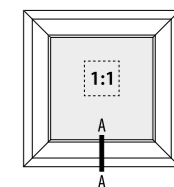
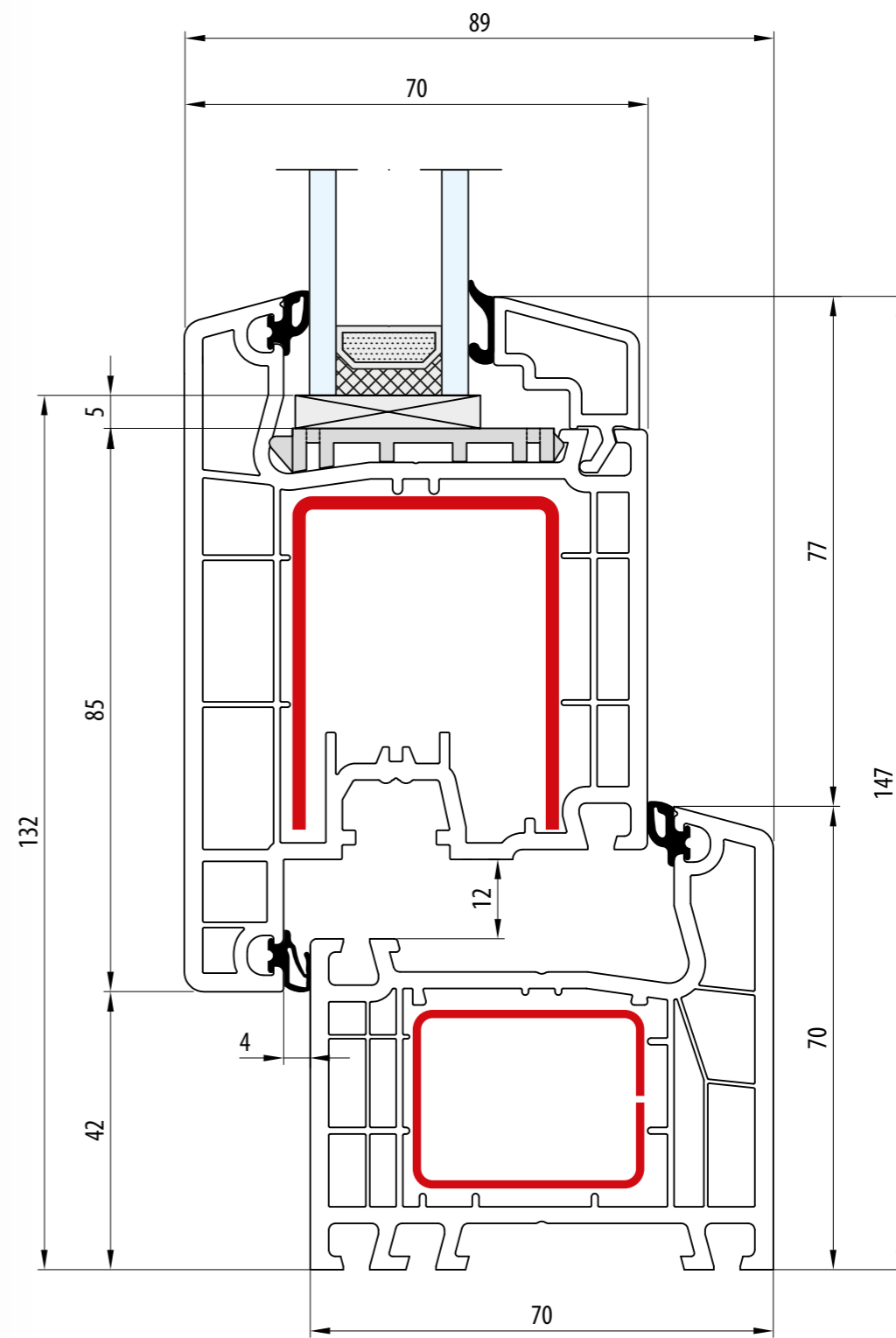

- Rama: 70 mm · Skrzydło: 105 mm
- Dormant: 70 mm · Vantail: 105 mm
- Frame: 70 mm · Sash: 105 mm
- Rahmen: 70 mm · Flügel: 105 mm
- Telaio: 70 mm · Anta: 105 mm

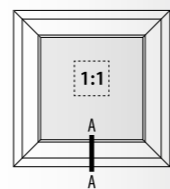
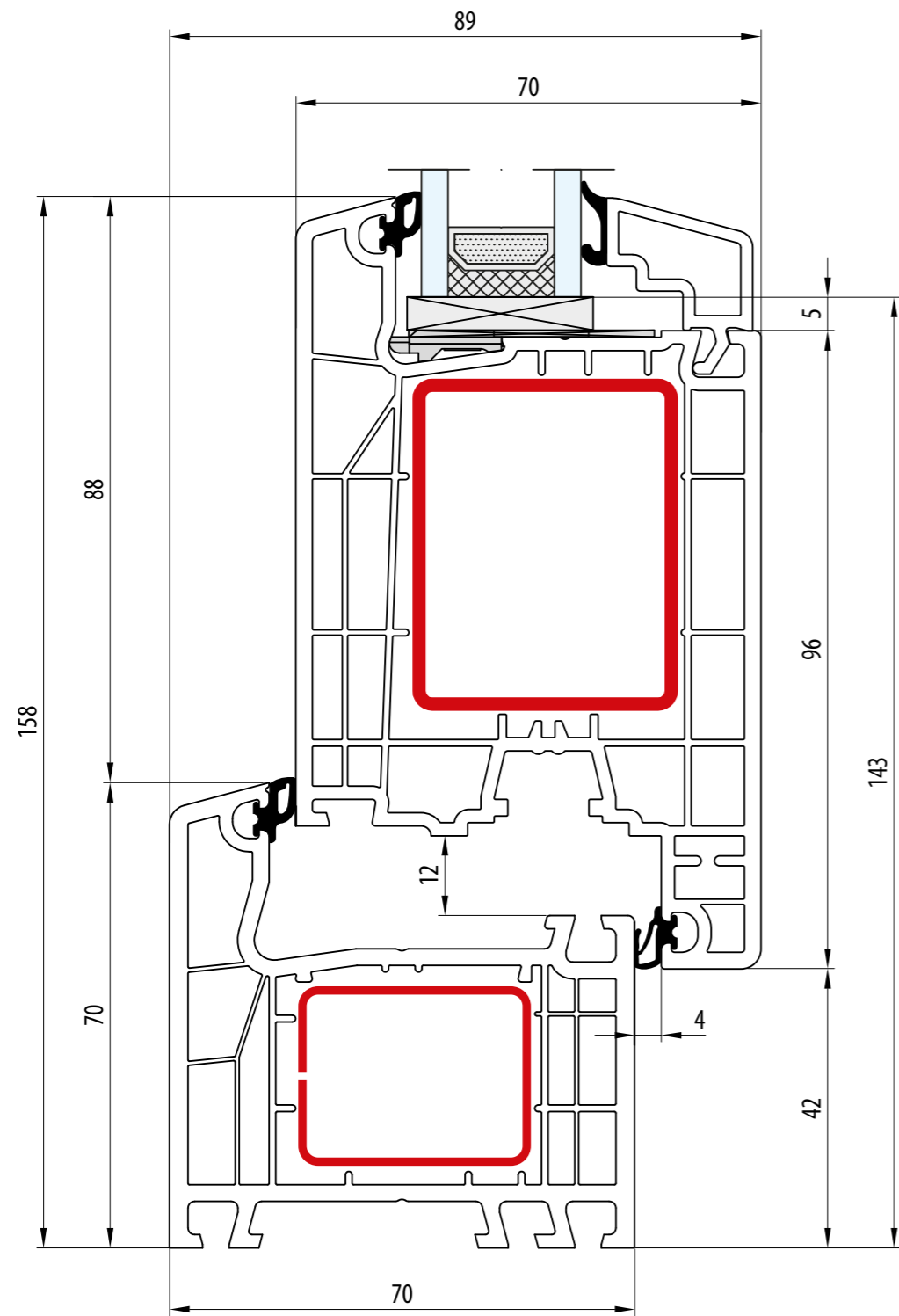

- Rama: 70 mm · Skrzydło: 116 mm
- Dormant: 70 mm · Vantail: 116 mm
- Frame: 70 mm · Sash: 116 mm
- Rahmen: 70 mm · Flügel: 116 mm
- Telaio: 70 mm · Anta: 116 mm

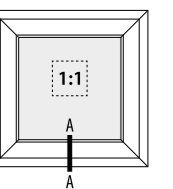
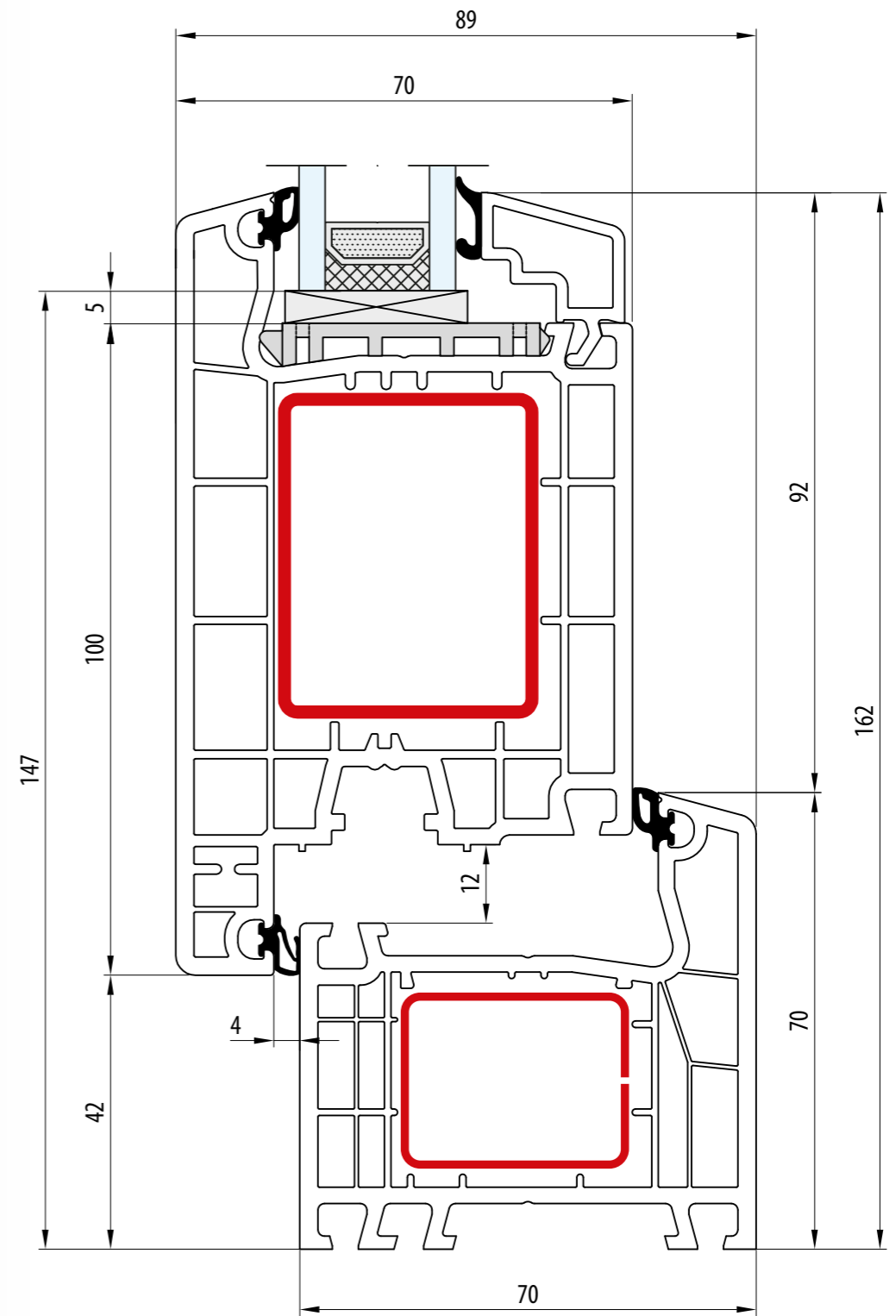

- Rama: 70 mm · Skrzydło: 120 mm
- Dormant: 70 mm · Vantail: 120 mm
- Frame: 70 mm · Sash: 120 mm
- Rahmen: 70 mm · Flügel: 120 mm
- Telaio: 70 mm · Anta: 120 mm

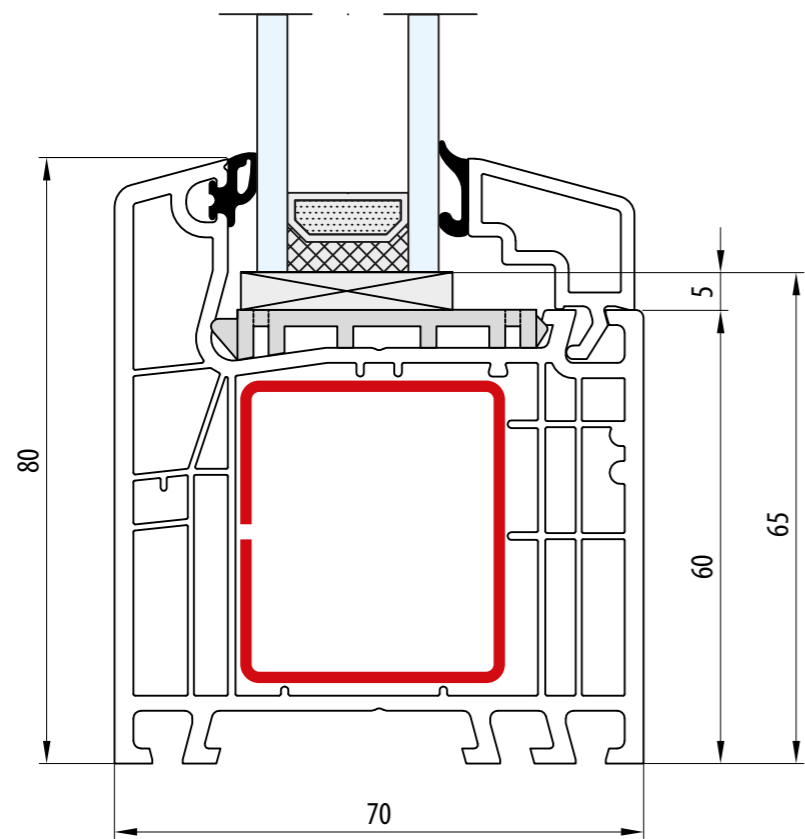

- Rama: 80 mm
- Dormant: 80 mm
- Frame: 80 mm
- Rahmen: 80 mm
- Telaio: 80 mm

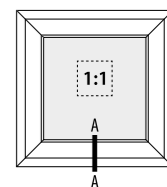
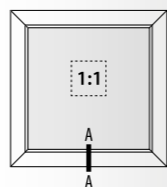

- Rama: 80 mm · Skrzydło: 77 mm
- Dormant: 80 mm · Vantail: 77 mm
- Frame: 80 mm · Sash: 77 mm
- Rahmen: 80 mm · Flügel: 77 mm
- Telaio: 80 mm · Anta: 77 mm

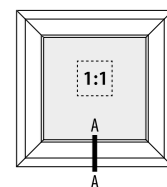

- Rama: 80 mm · Skrzydło: 77 mm
- Dormant: 80 mm · Vantail: 77 mm
- Frame: 80 mm · Sash: 77 mm
- Rahmen: 80 mm · Flügel: 77 mm
- Telaio: 80 mm · Anta: 77 mm

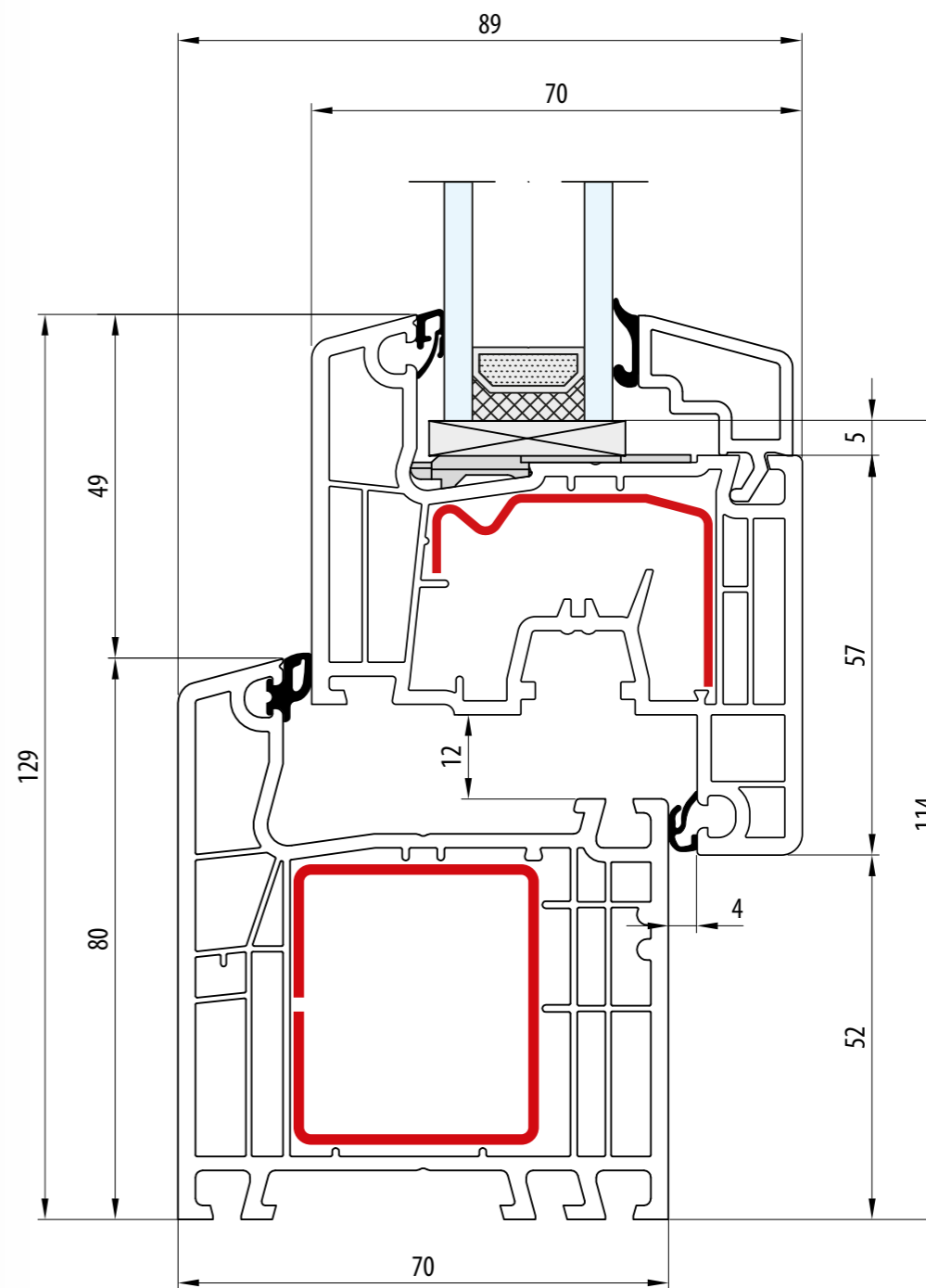

- Rama: 80 mm · Skrzydło: 77 mm
- Dormant: 80 mm · Vantail: 77 mm
- Frame: 80 mm · Sash: 77 mm
- Rahmen: 80 mm · Flügel: 77 mm
- Telaio: 80 mm · Anta: 77 mm

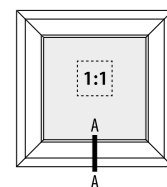

- Rama: 80 mm · Skrzydło: 77 mm
- Dormant: 80 mm · Vantail: 77 mm
- Frame: 80 mm · Sash: 77 mm
- Rahmen: 80 mm · Flügel: 77 mm
- Telaio: 80 mm · Anta: 77 mm

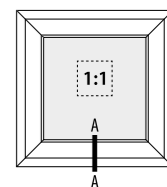

- Rama: 80 mm · Skrzydło: 77 mm
- Dormant: 80 mm · Vantail: 77 mm
- Frame: 80 mm · Sash: 77 mm
- Rahmen: 80 mm · Flügel: 77 mm
- Telaio: 80 mm · Anta: 77 mm



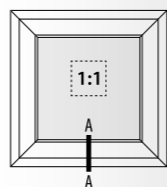
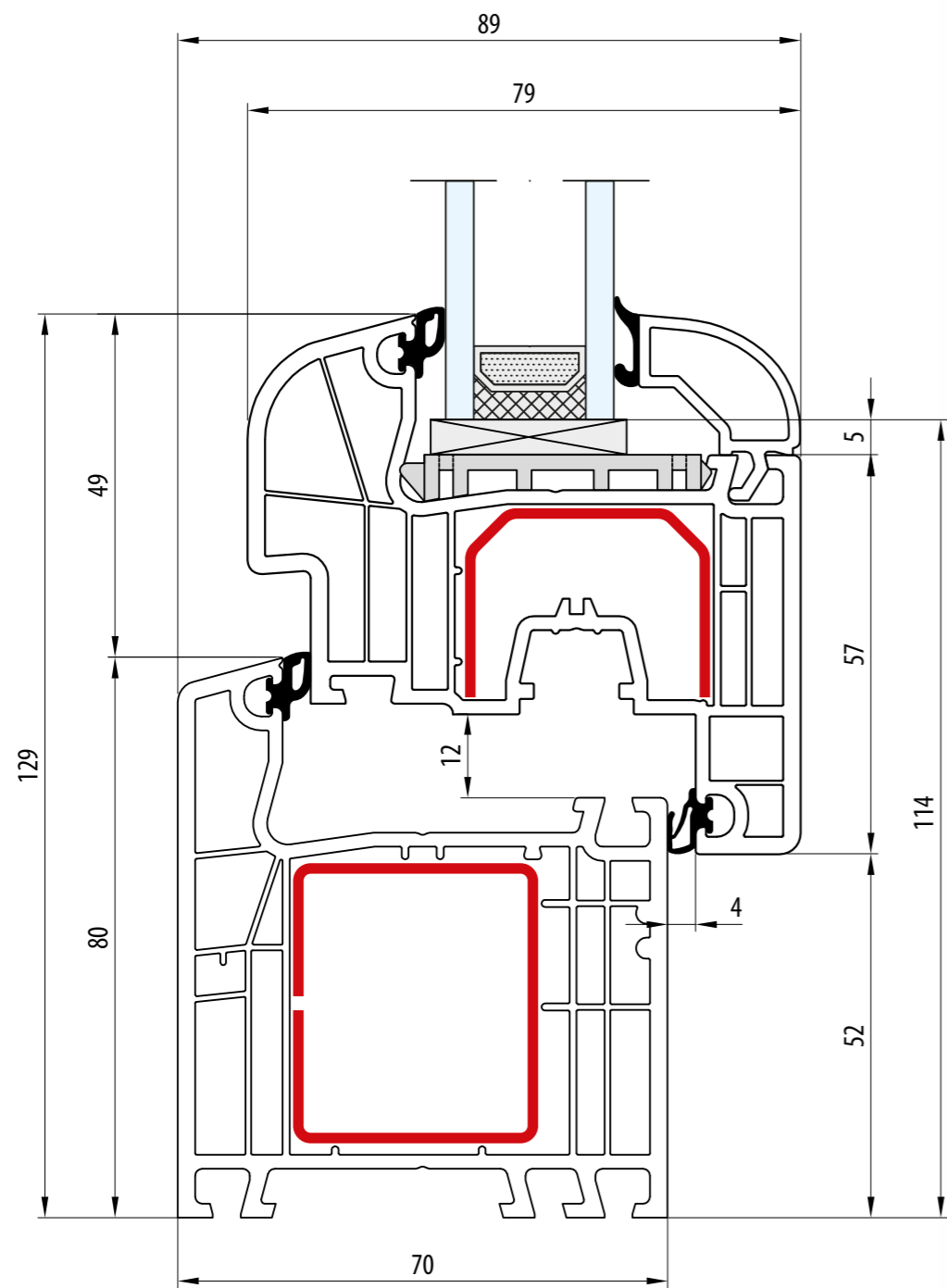

- Rama: 80 mm · Skrzydło: 77 mm
- Dormant: 80 mm · Vantail: 77 mm
- Frame: 80 mm · Sash: 77 mm
- Rahmen: 80 mm · Flügel: 77 mm
- Telaio: 80 mm · Anta: 77 mm

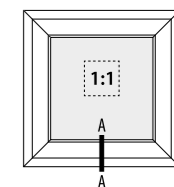
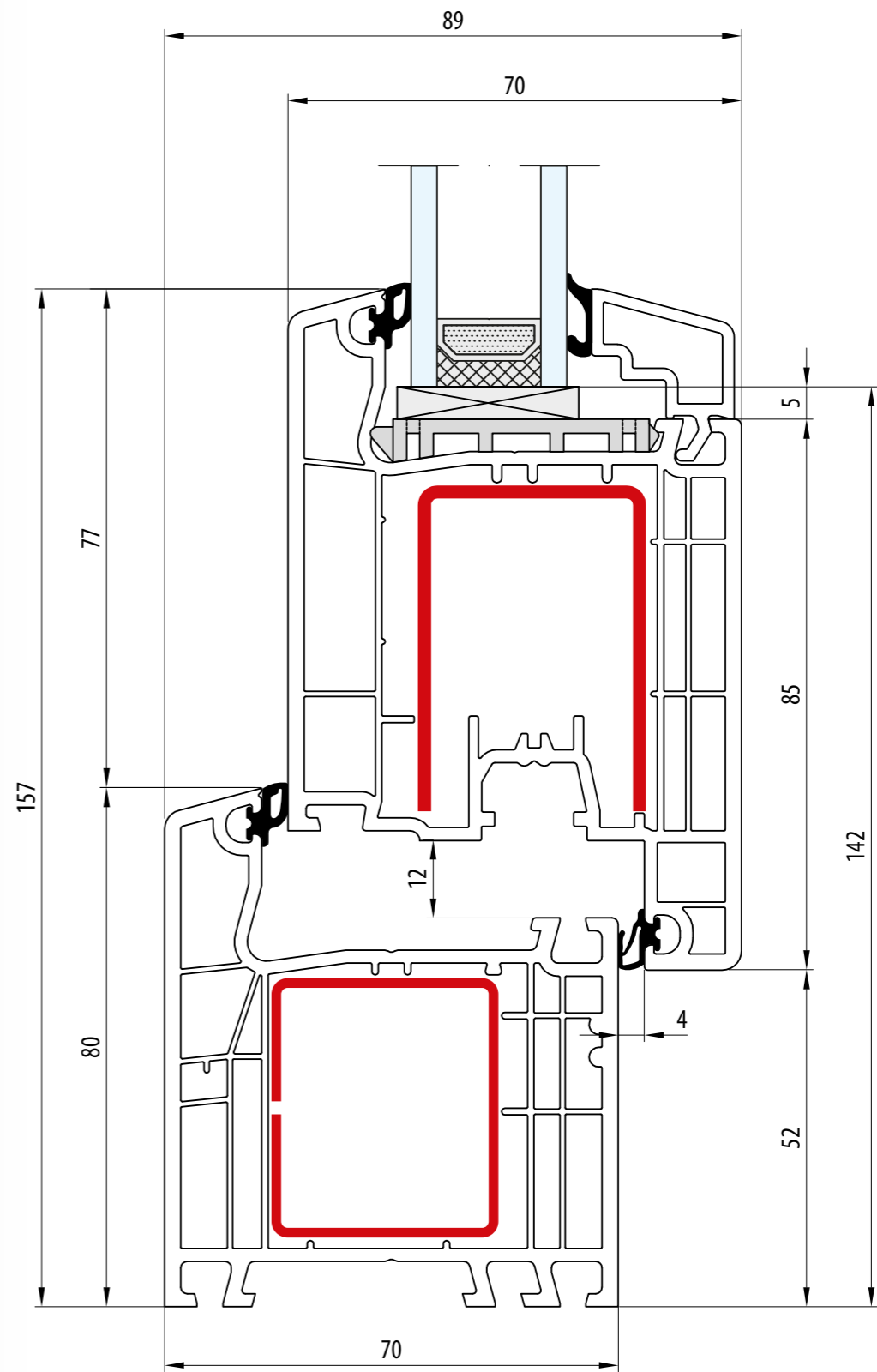

- Rama: 80 mm · Skrzydło: 105 mm
- Dormant: 80 mm · Vantail: 105 mm
- Frame: 80 mm · Sash: 105 mm
- Rahmen: 80 mm · Flügel: 105 mm
- Telaio: 80 mm · Anta: 105 mm

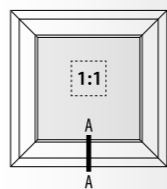
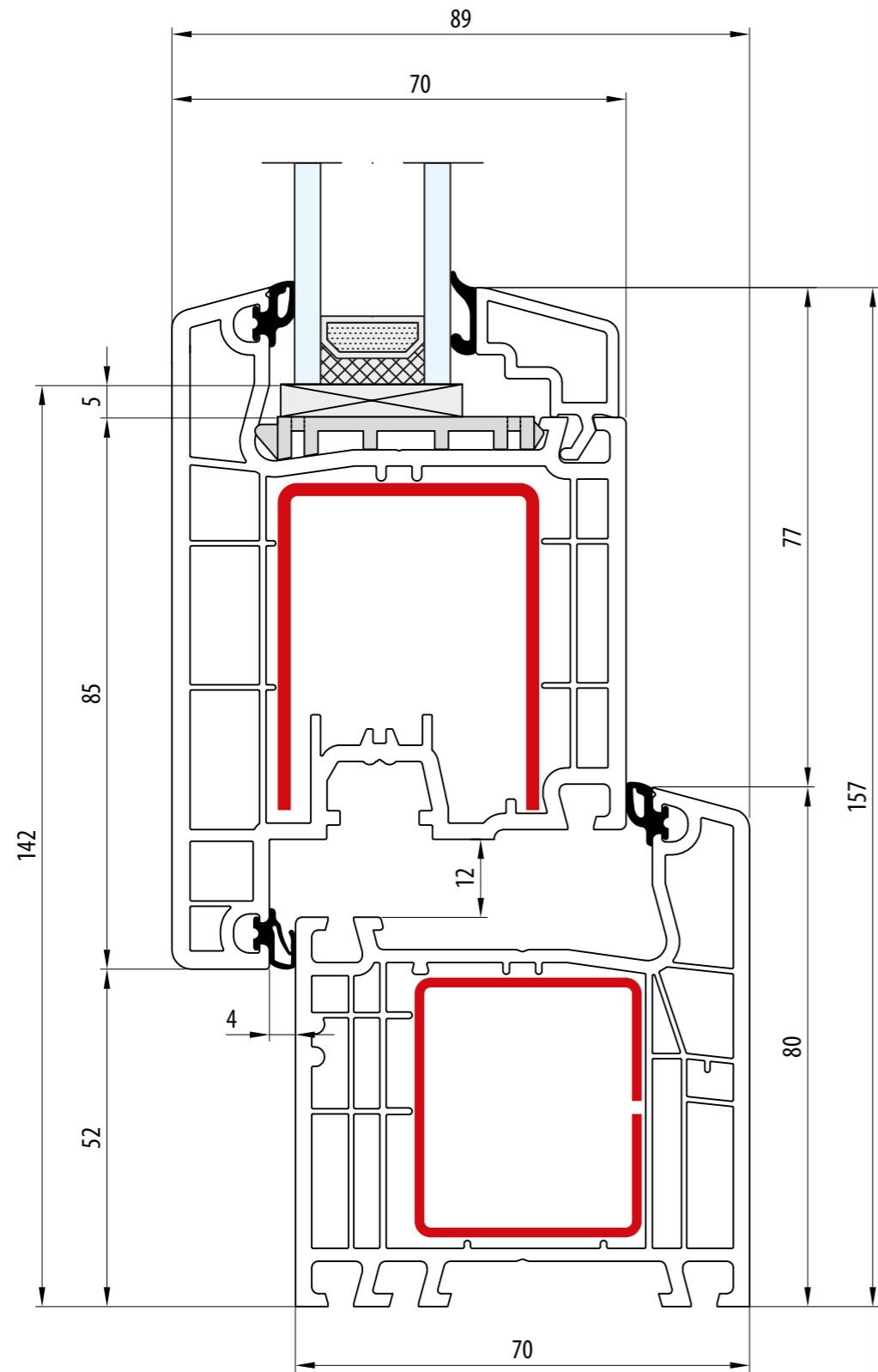

- Rama: 80 mm · Skrzydło: 105 mm
- Dormant: 80 mm · Vantail: 105 mm
- Frame: 80 mm · Sash: 105 mm
- Rahmen: 80 mm · Flügel: 105 mm
- Telaio: 80 mm · Anta: 105 mm

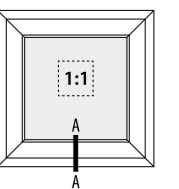
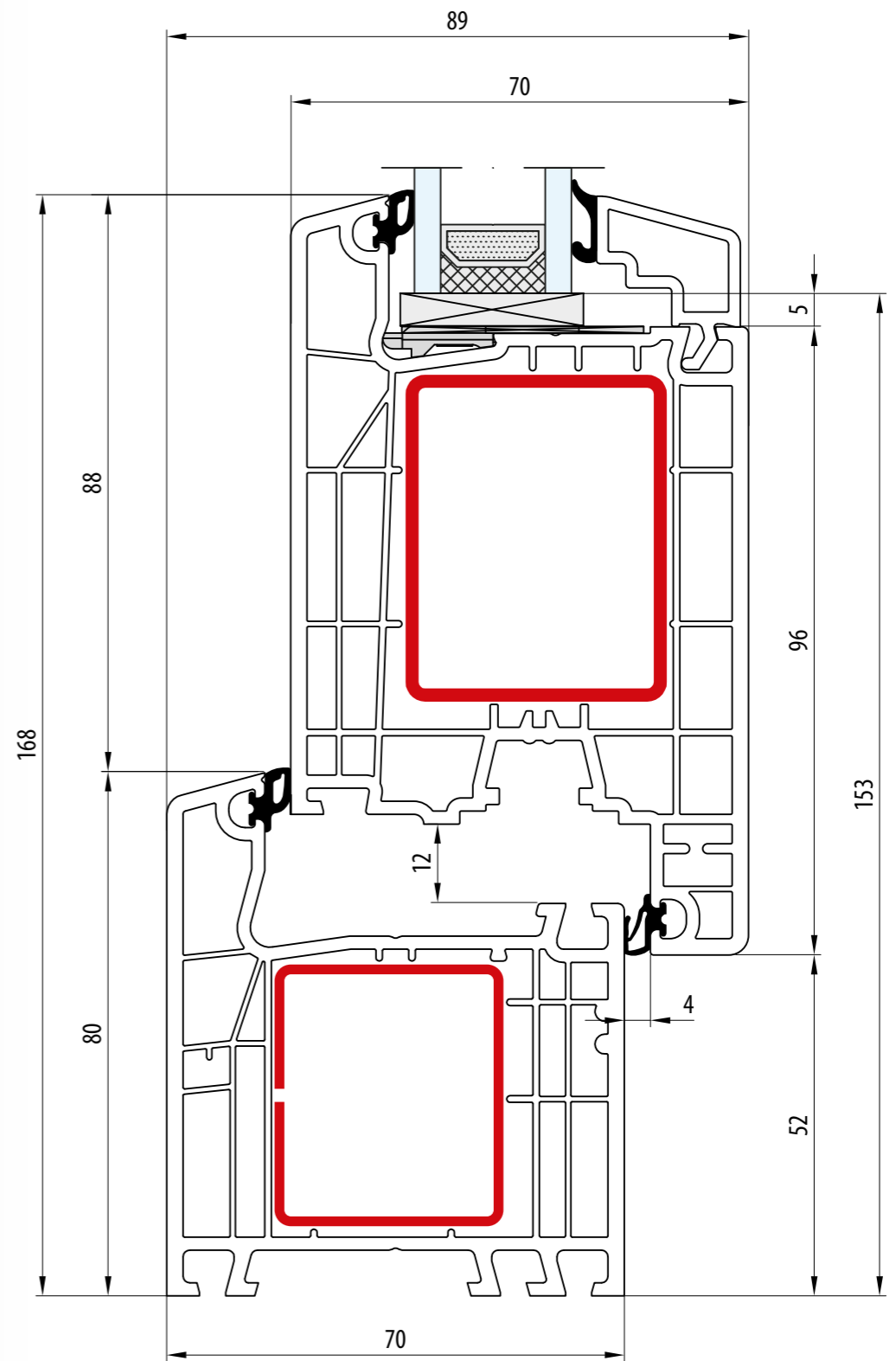

- Rama: 80 mm · Skrzydło: 116 mm
- Dormant: 80 mm · Vantail: 116 mm
- Frame: 80 mm · Sash: 116 mm
- Rahmen: 80 mm · Flügel: 116 mm
- Telaio: 80 mm · Anta: 116 mm

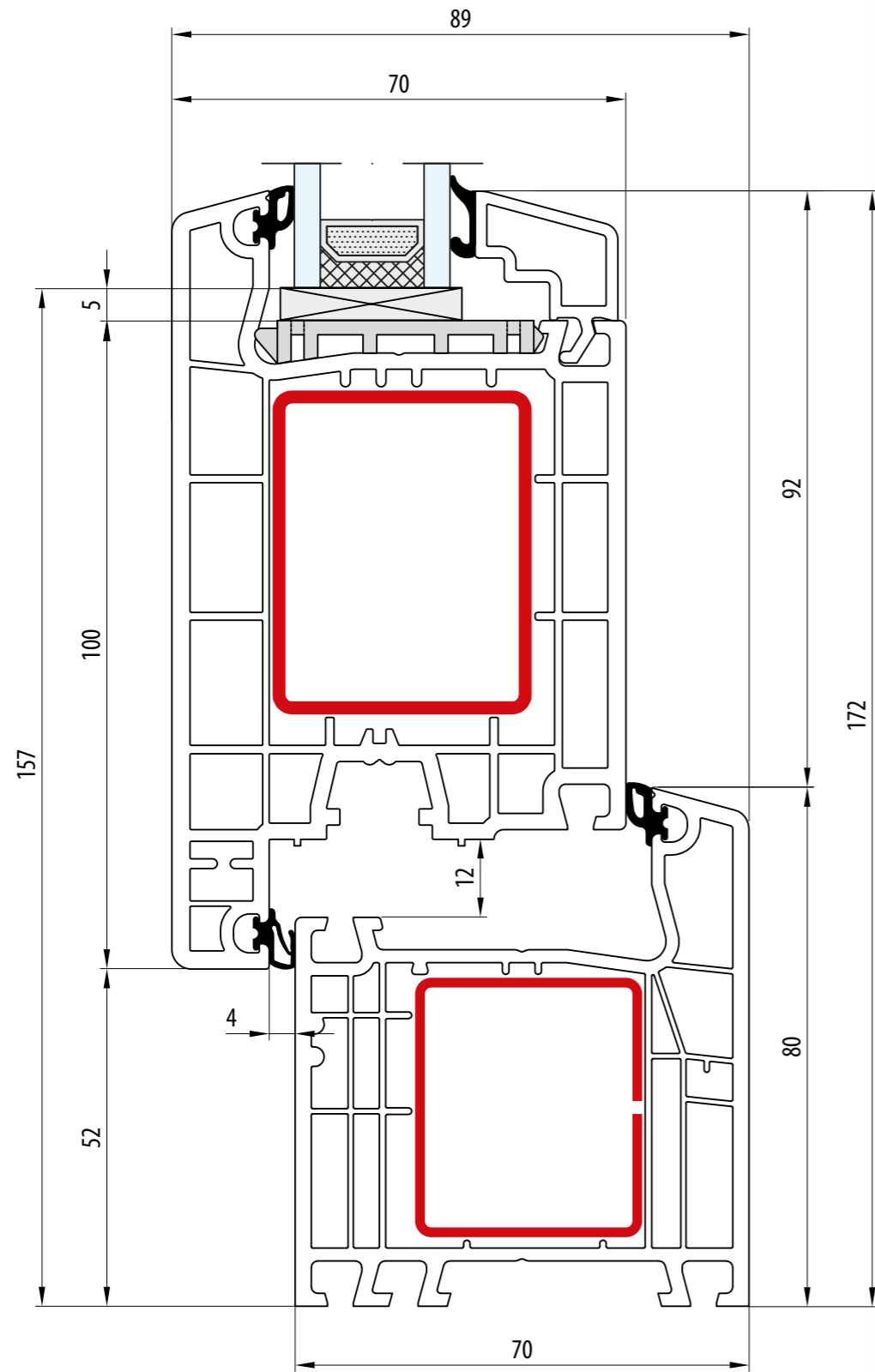

- Rama: 80 mm · Skrzydło: 120 mm
- Dormant: 80 mm · Vantail: 120 mm
- Frame: 80 mm · Sash: 120 mm
- Rahmen: 80 mm · Flügel: 120 mm
- Telaio: 80 mm · Anta: 120 mm

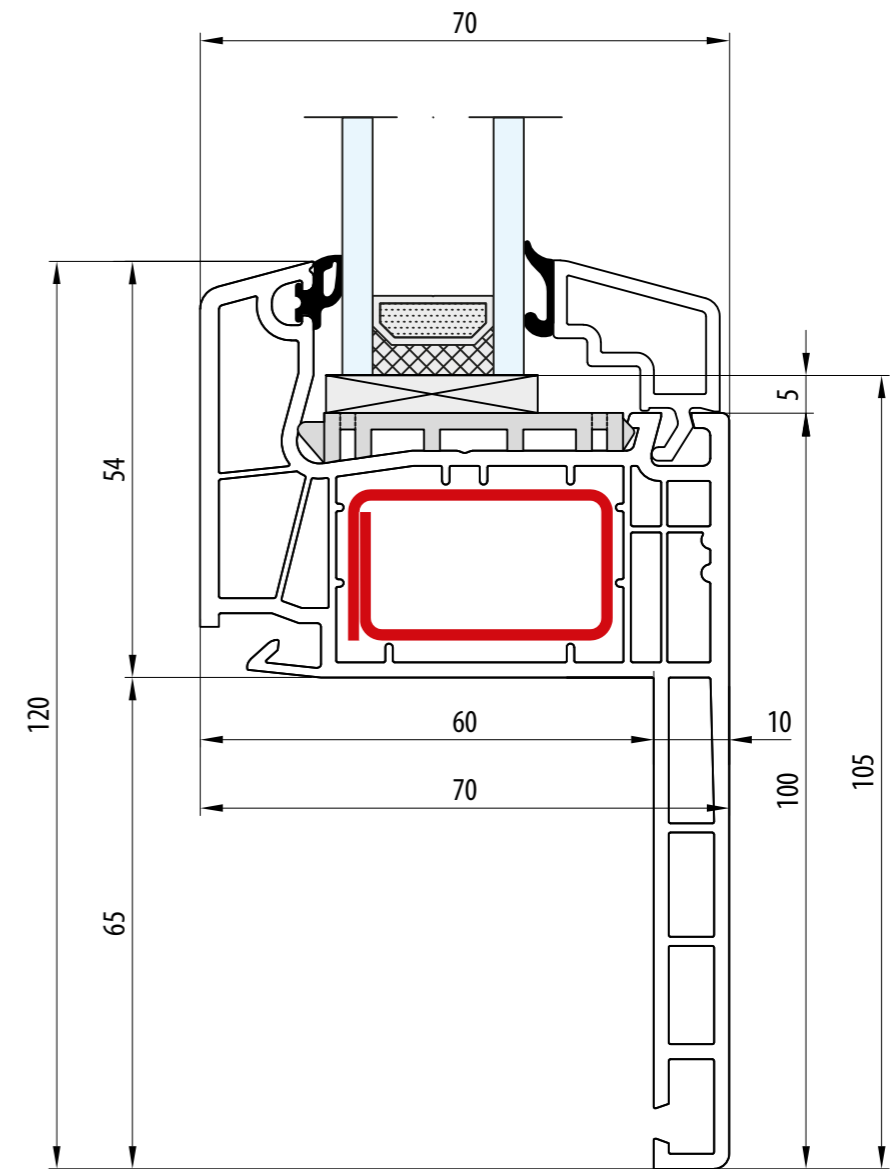
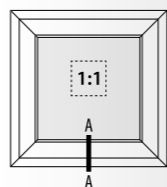

- RENOWACJA - Pletwa: 65 mm · Rama: 54 mm
- RÉNOVATION - Lip: 65 mm · Dormant: 54 mm
- RENOVATION - Strip: 65 mm · Frame: 54 mm
- RENOVIERUNG - Flosse: 65 mm · Rahmen: 54 mm
- RINNOVAZIONE - Aletta da: 65 mm · Telaio: 54 mm

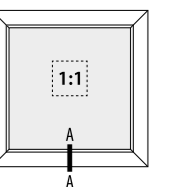

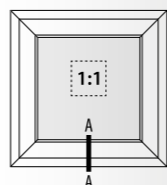
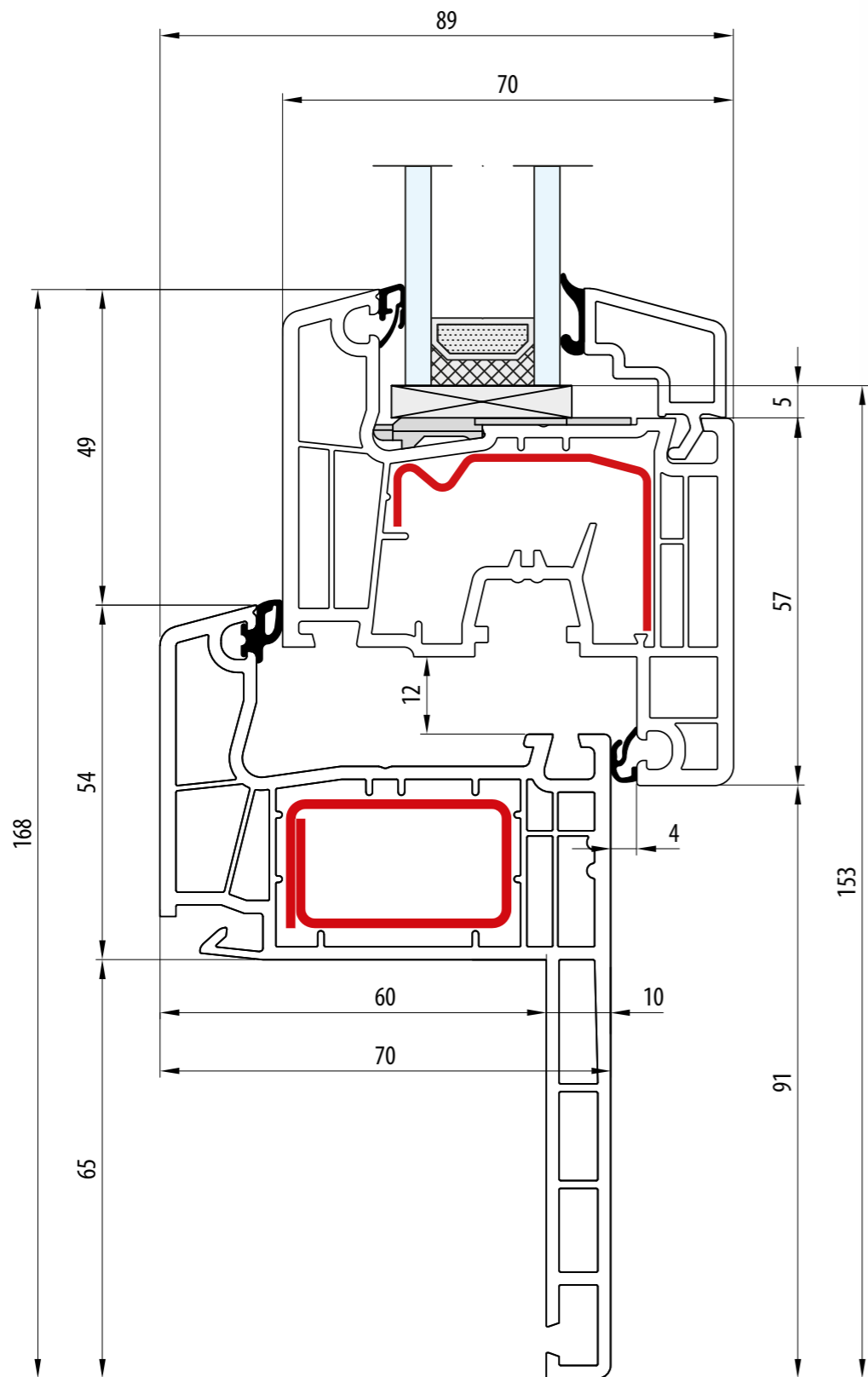

- RENOWACJA - Pletwa: 65 mm · Rama: 54 mm · Skrzydło: 77 mm
- RÉNOVATION - Lip: 65 mm · Dormant: 54 mm · Vantail: 77 mm
- RENOVATION - Strip: 65 mm · Frame: 54 mm · Sash: 77 mm
- RENOVIERUNG - Flosse: 65 mm · Rahmen: 54 mm · Flügel: 77 mm
- RINNOVAZIONE - Aletta da: 65 mm · Telaio: 54 mm · Anta: 77 mm

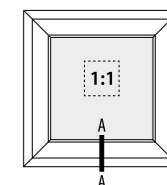
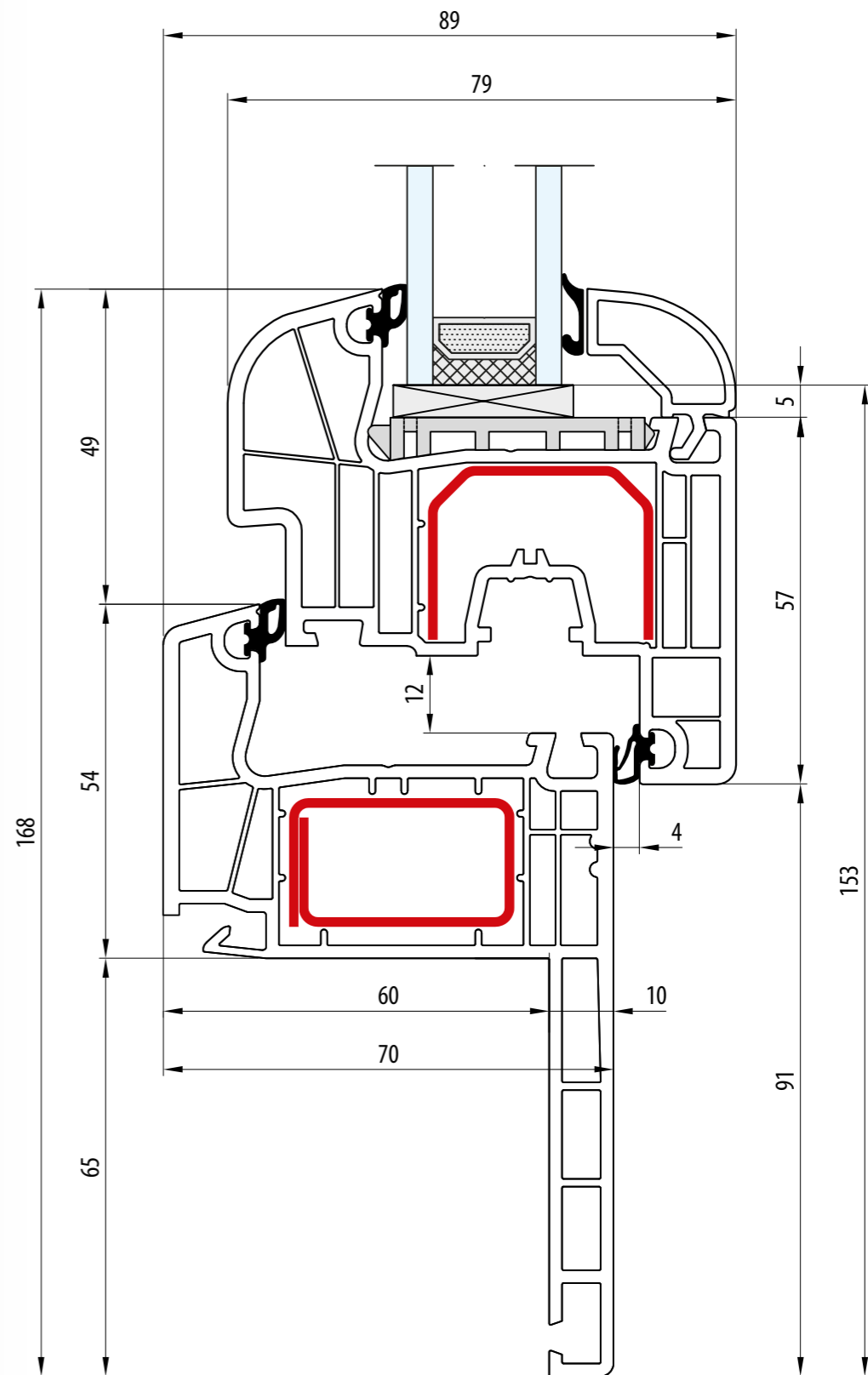

- RENOWACJA - Pletwa: 65 mm · Rama: 54 mm · Skrzydło: 77 mm
- RÉNOVATION - Lip: 65 mm · Dormant: 54 mm · Vantail: 77 mm
- RENOVATION - Strip: 65 mm · Frame: 54 mm · Sash: 77 mm
- RENOVIERUNG - Flosse: 65 mm · Rahmen: 54 mm · Flügel: 77 mm
- RINNOVAZIONE - Aletta da: 65 mm · Telaio: 54 mm · Anta: 77 mm

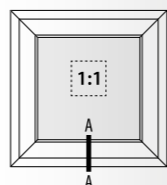
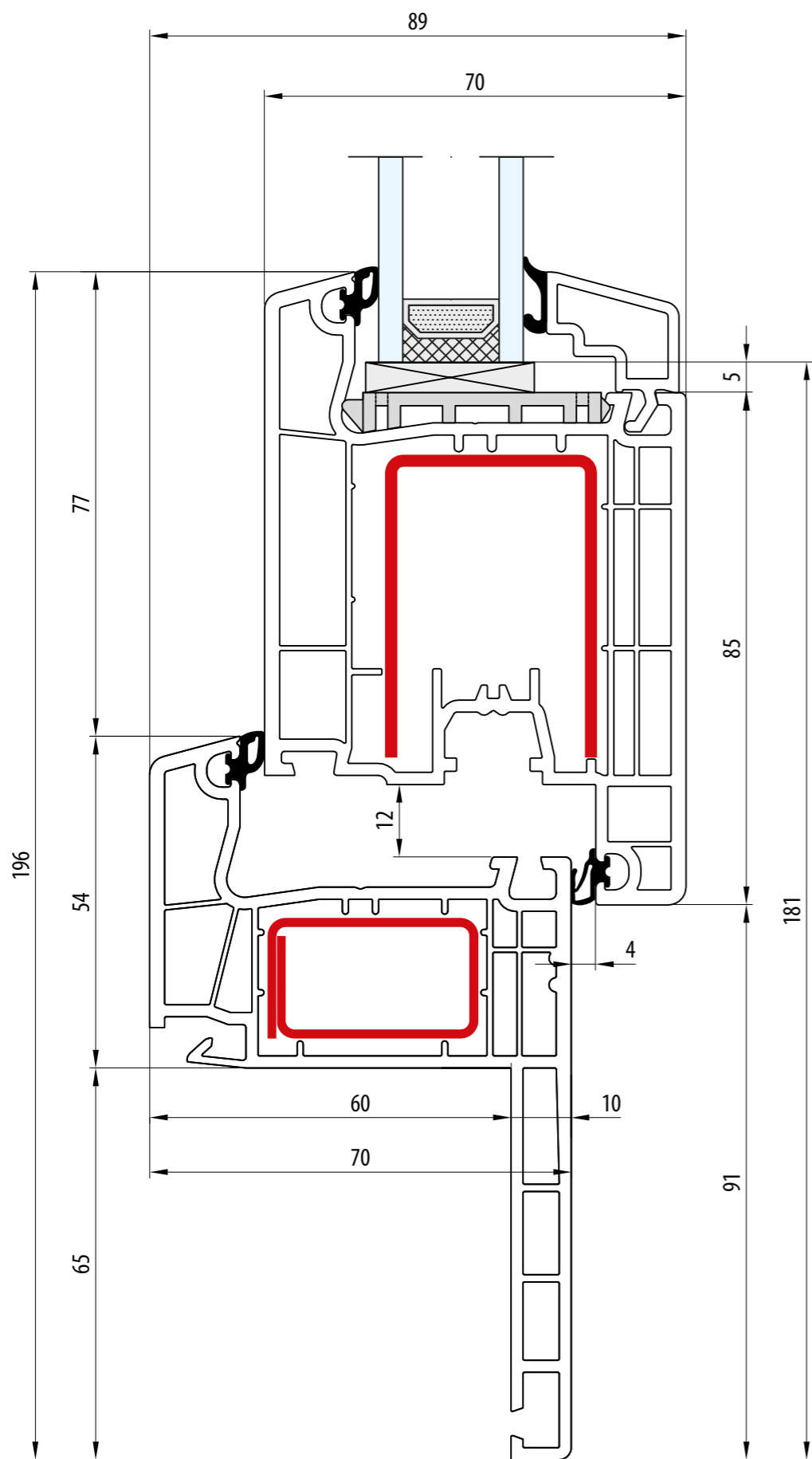

- RENOWACJA - Pletwa: 65 mm · Rama: 54 mm · Skrzydło: 105 mm
- RÉNOVATION - Lip: 65 mm · Dormant: 54 mm · Vantail: 105 mm
- RENOVATION - Strip: 65 mm · Frame: 54 mm · Sash: 105 mm
- RENOVIERUNG - Flosse: 65 mm · Rahmen: 54 mm · Flügel: 105 mm
- RINNOVAZIONE - Aletta da: 65 mm · Telaio: 54 mm · Anta: 105 mm

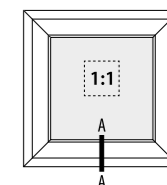
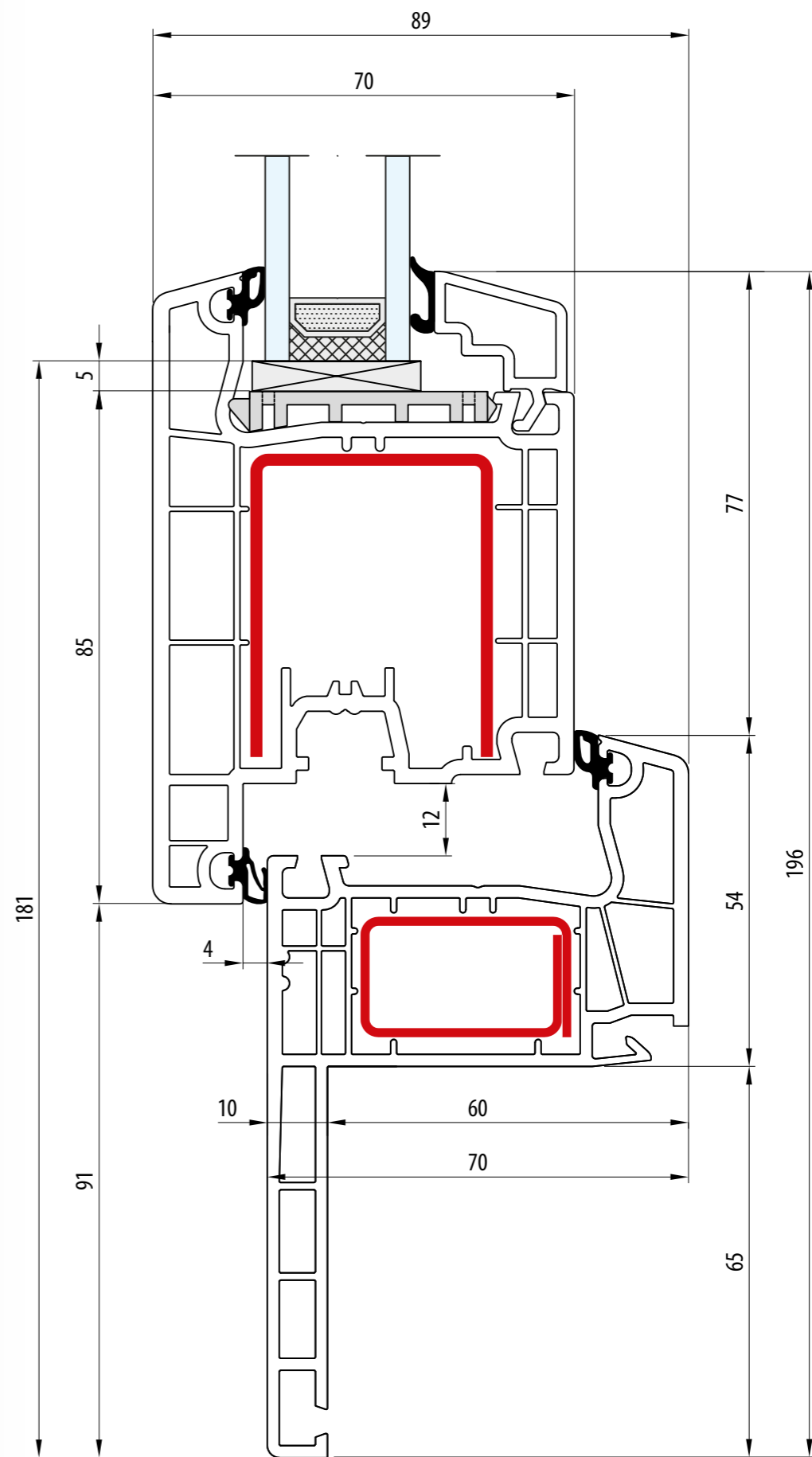

- RENOWACJA - Pletwa: 65 mm · Rama: 54 mm · Skrzydło: 105 mm
- RÉNOVATION - Lip: 65 mm · Dormant: 54 mm · Vantail: 105 mm
- RENOVATION - Strip: 65 mm · Frame: 54 mm · Sash: 105 mm
- RENOVIERUNG - Flosse: 65 mm · Rahmen: 54 mm · Flügel: 105 mm
- RINNOVAZIONE - Aletta da: 65 mm · Telaio: 54 mm · Anta: 105 mm

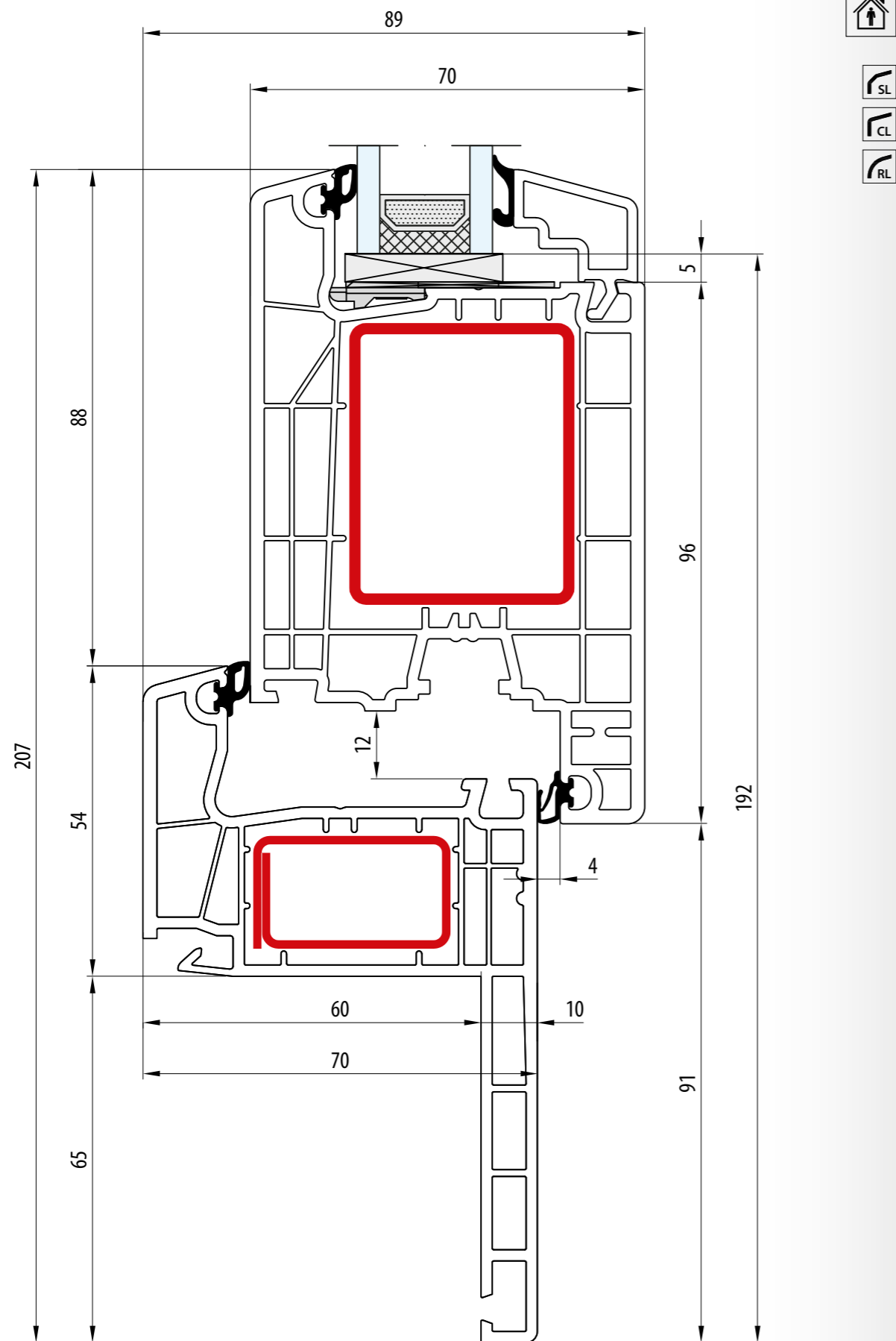

- RENOWACJA - Pletwa: 65 mm · Rama: 54 mm · Skrzydło: 116 mm
- RÉNOVATION - Lip: 65 mm · Dormant: 54 mm · Vantail: 116 mm
- RENOVATION - Strip: 65 mm · Frame: 54 mm · Sash: 116 mm
- RENOVIERUNG - Flosse: 65 mm · Rahmen: 54 mm · Flügel: 116 mm
- RINNOVAZIONE - Aletta da: 65 mm · Telaio: 54 mm · Anta: 116 mm

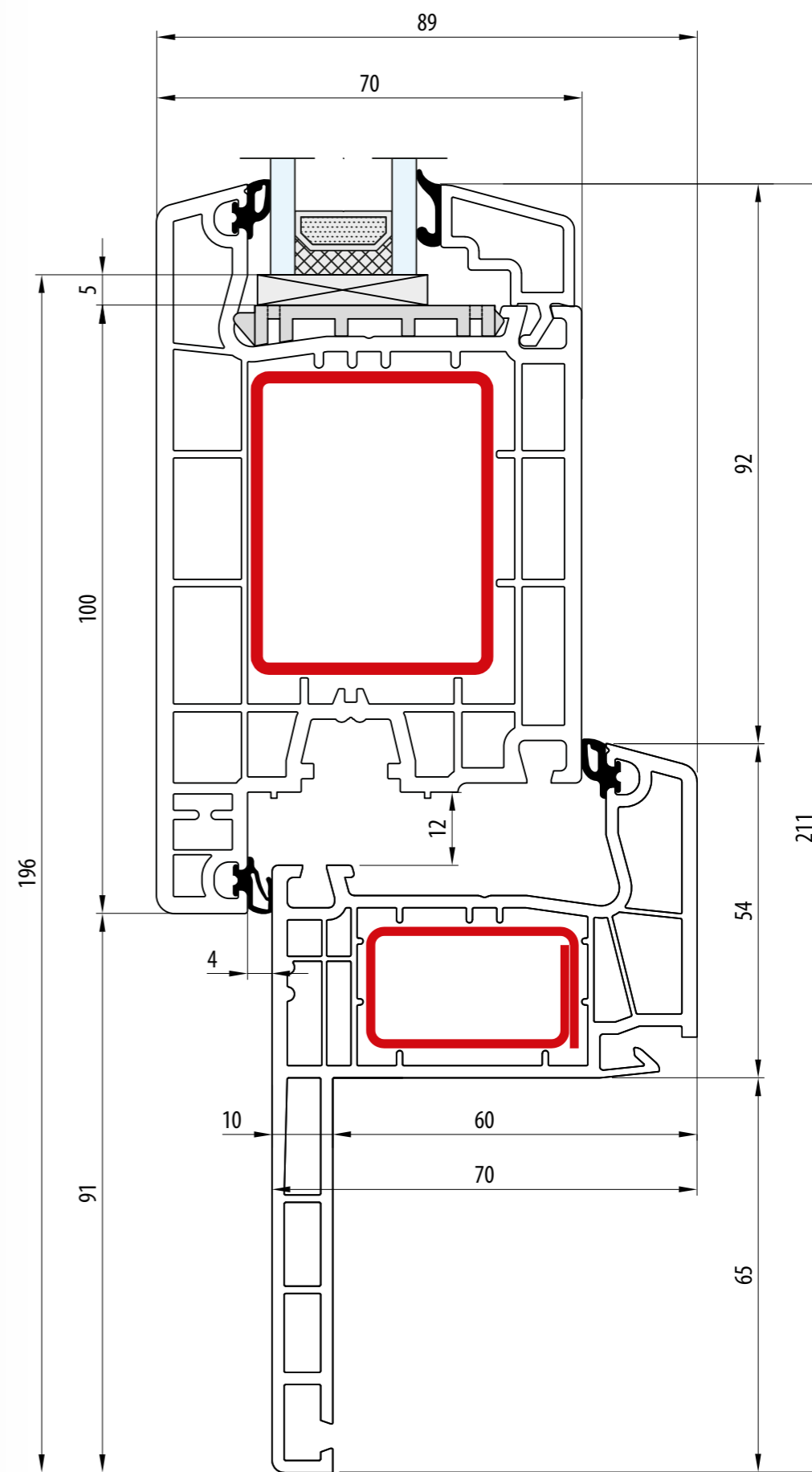
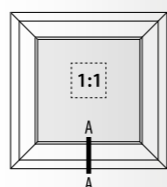

- RENOWACJA - Pletwa: 65 mm · Rama: 54 mm · Skrzydło: 105 mm
- RÉNOVATION - Lip: 65 mm · Dormant: 54 mm · Vantail: 105 mm
- RENOVATION - Strip: 65 mm · Frame: 54 mm · Sash: 105 mm
- RENOVIERUNG - Flosse: 65 mm · Rahmen: 54 mm · Flügel: 105 mm
- RINNOVAZIONE - Aletta da: 65 mm · Telaio: 54 mm · Anta: 105 mm

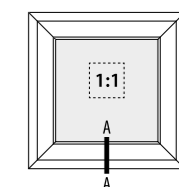

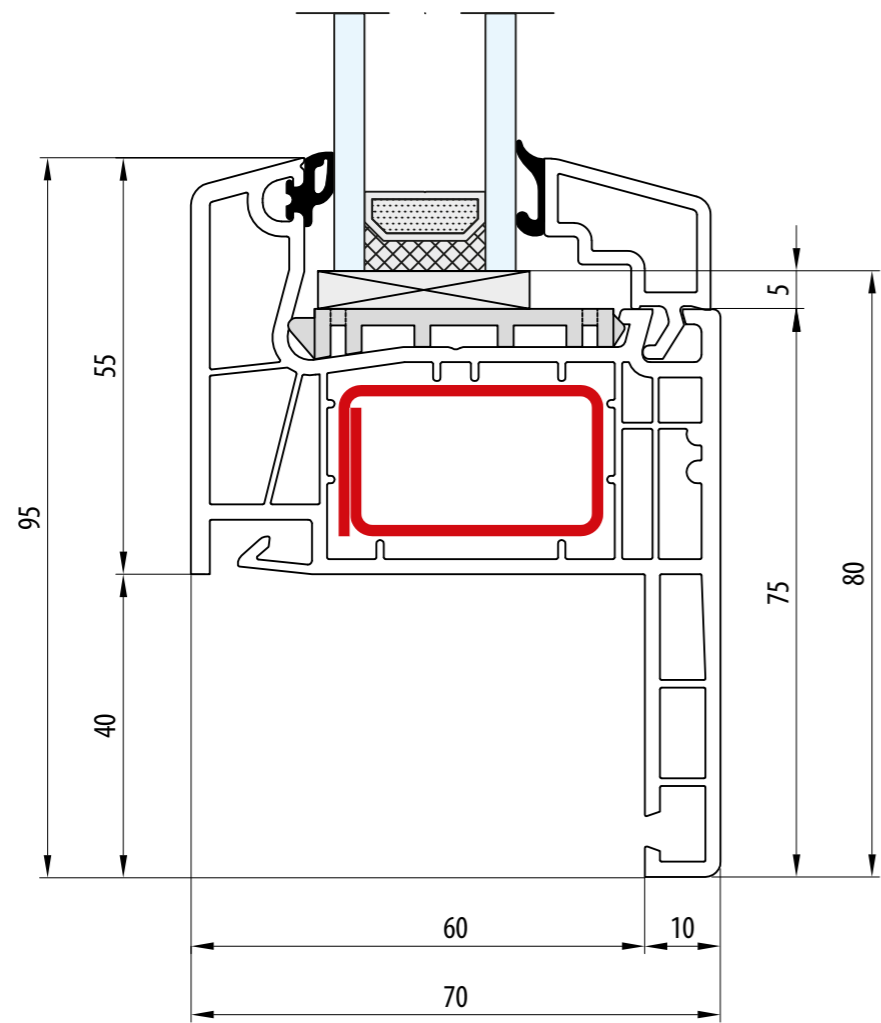

- RENOWACJA - Pletwa: 40 mm · Rama: 55 mm
- RÉNOVATION - Lip: 40 mm · Dormant: 55 mm
- RENOVATION - Strip: 40 mm · Frame: 55 mm
- RENOVIERUNG - Flosse: 40 mm · Rahmen: 55 mm
- RINNOVAZIONE - Aletta da: 40 mm · Telaio: 55 mm

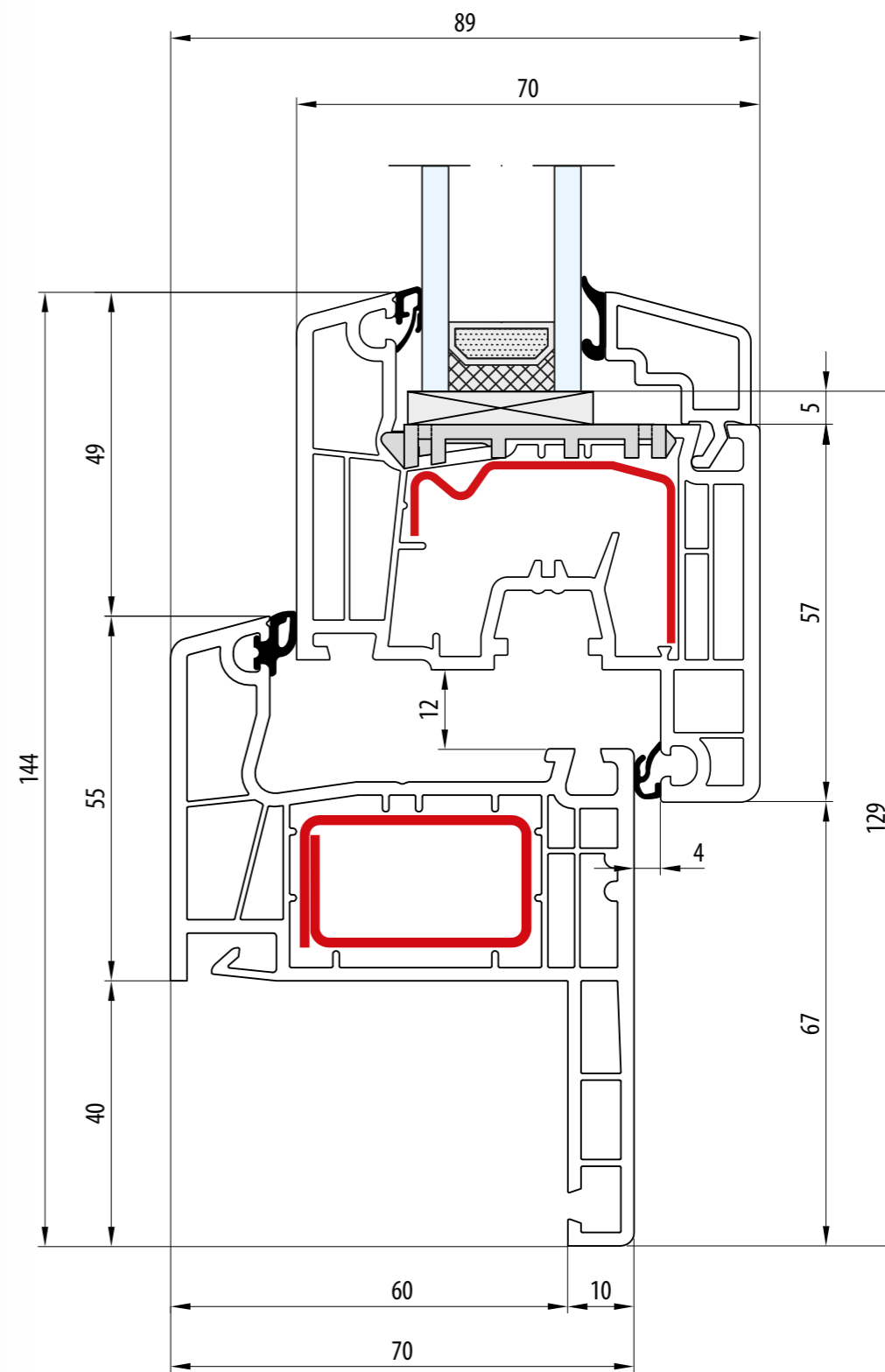
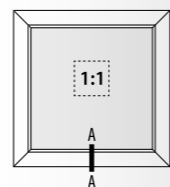

- RENOWACJA - Pletwa: 40 mm · Rama: 55 mm · Skrzydło: 77 mm
- RÉNOVATION - Lip: 40 mm · Dormant: 55 mm · Vantail: 77 mm
- RENOVATION - Strip: 40 mm · Frame: 55 mm · Sash: 77 mm
- RENOVIERUNG - Flosse: 40 mm · Rahmen: 55 mm · Flügel: 77 mm
- RINNOVAZIONE - Aletta da: 40 mm · Telaio: 55 mm · Anta: 77 mm

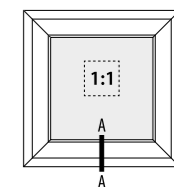

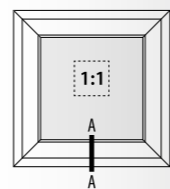
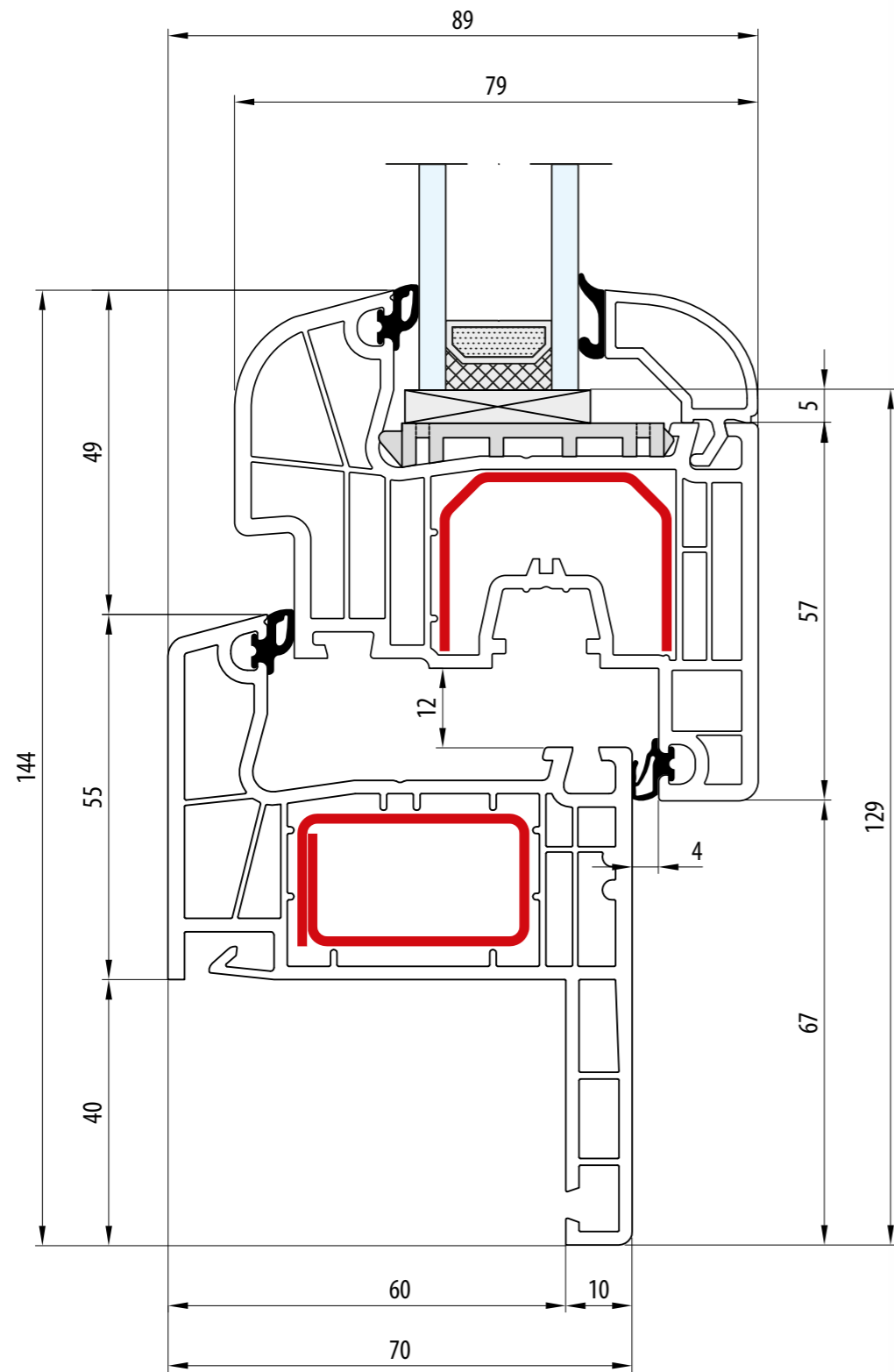

- RENOWACJA - Pletwa: 40 mm · Rama: 55 mm · Skrzydło: 77 mm
- RÉNOVATION - Lip: 40 mm · Dormant: 55 mm · Vantail: 77 mm
- RENOVATION - Strip: 40 mm · Frame: 55 mm · Sash: 77 mm
- RENOVIERUNG - Flosse: 40 mm · Rahmen: 55 mm · Flügel: 77 mm
- RINNOVAZIONE - Aletta da: 40 mm · Telaio: 55 mm · Anta: 77 mm

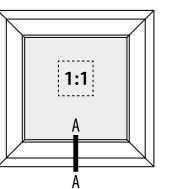
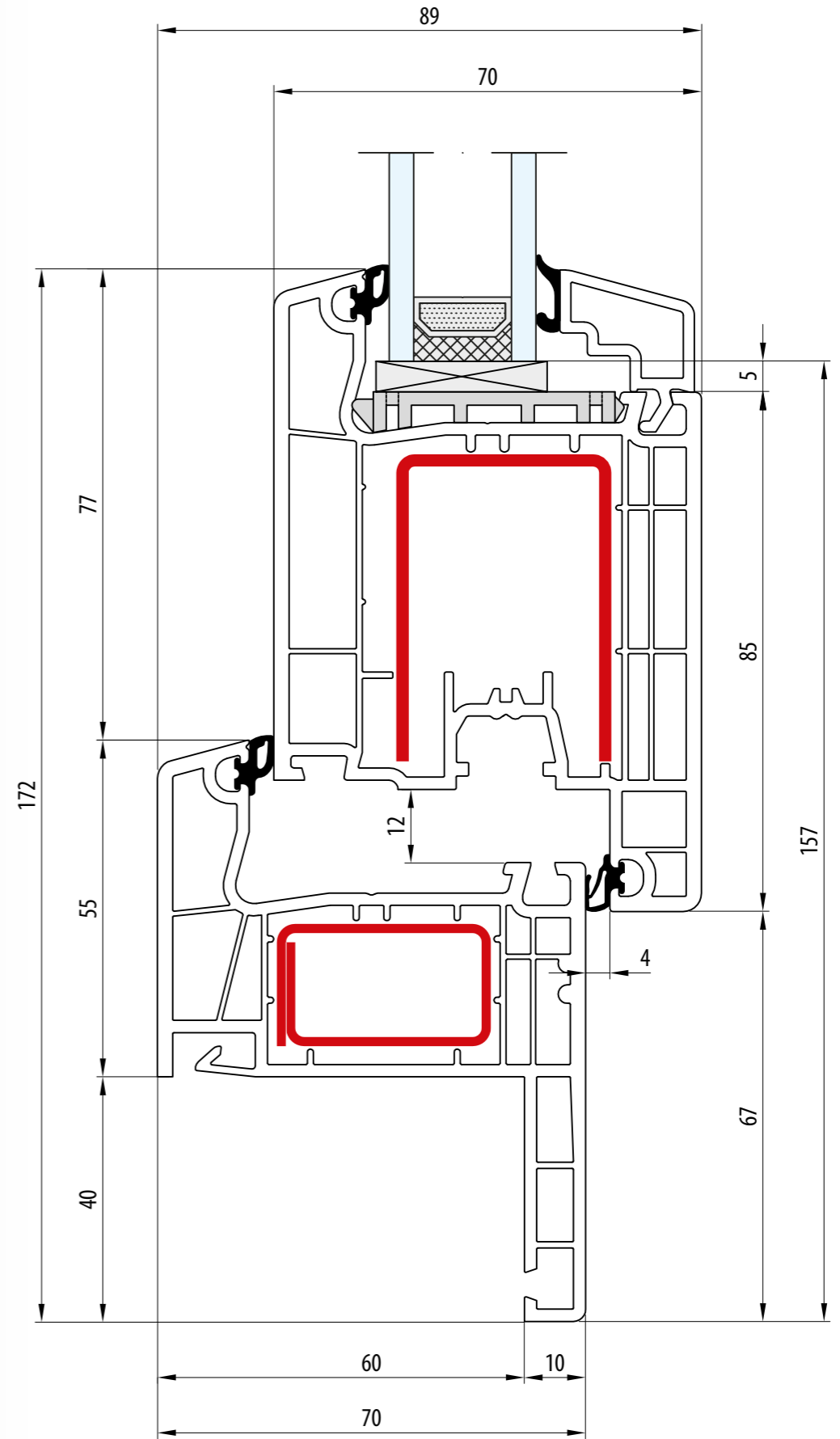

- RENOWACJA - Pletwa: 40 mm · Rama: 55 mm · Skrzydło: 105 mm
- RÉNOVATION - Lip: 40 mm · Dormant: 55 mm · Vantail: 105 mm
- RENOVATION - Strip: 40 mm · Frame: 55 mm · Sash: 105 mm
- RENOVIERUNG - Flosse: 40 mm · Rahmen: 55 mm · Flügel: 105 mm
- RINNOVAZIONE - Aletta da: 40 mm · Telaio: 55 mm · Anta: 105 mm

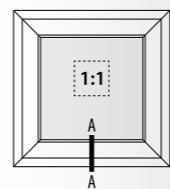
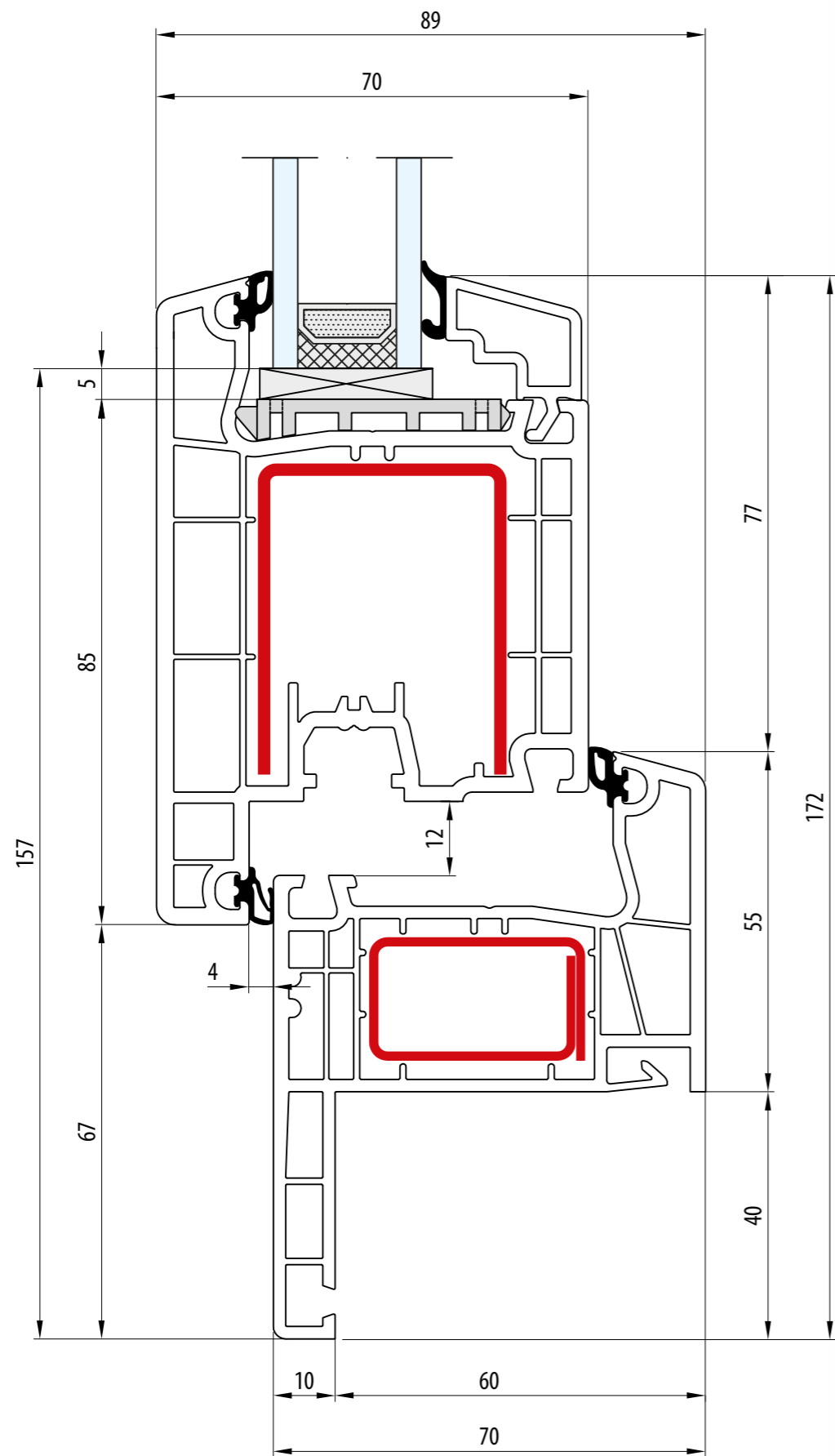

- RENOWACJA - Pletwa: 40 mm · Rama: 55 mm · Skrzydło: 105 mm
- RÉNOVATION - Lip: 40 mm · Dormant: 55 mm · Vantail: 105 mm
- RENOVATION - Strip: 40 mm · Frame: 55 mm · Sash: 105 mm
- RENOVIERUNG - Flosse: 40 mm · Rahmen: 55 mm · Flügel: 105 mm
- RINNOVAZIONE - Aletta da: 40 mm · Telaio: 55 mm · Anta: 105 mm

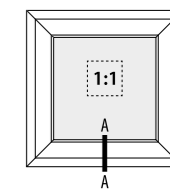
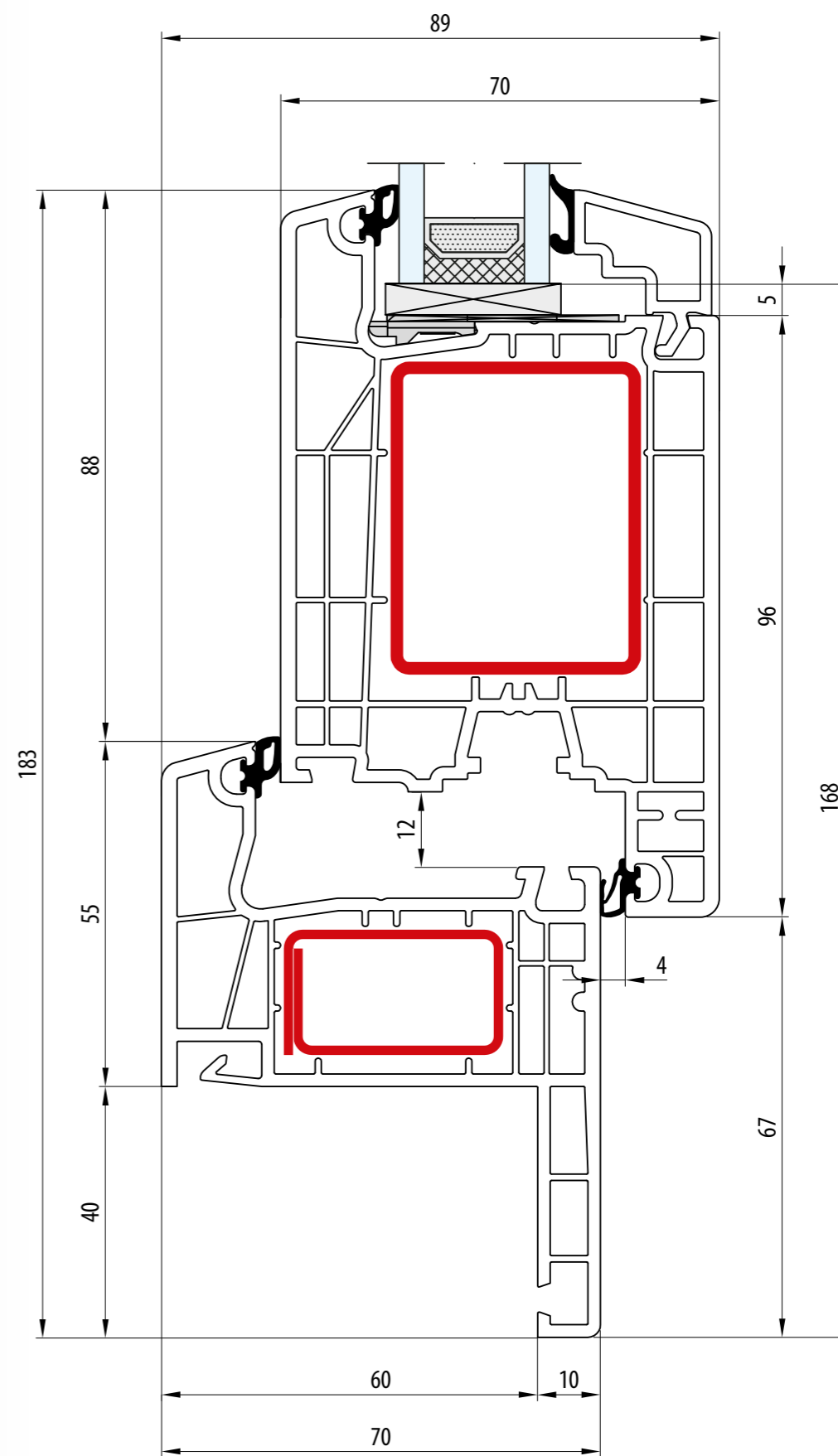

- RENOWACJA - Pletwa: 40 mm · Rama: 55 mm · Skrzydło: 116 mm
- RÉNOVATION - Lip: 40 mm · Dormant: 55 mm · Vantail: 116 mm
- RENOVATION - Strip: 40 mm · Frame: 55 mm · Sash: 116 mm
- RENOVIERUNG - Flosse: 40 mm · Rahmen: 55 mm · Flügel: 116 mm
- RINNOVAZIONE - Aletta da: 40 mm · Telaio: 55 mm · Anta: 116 mm

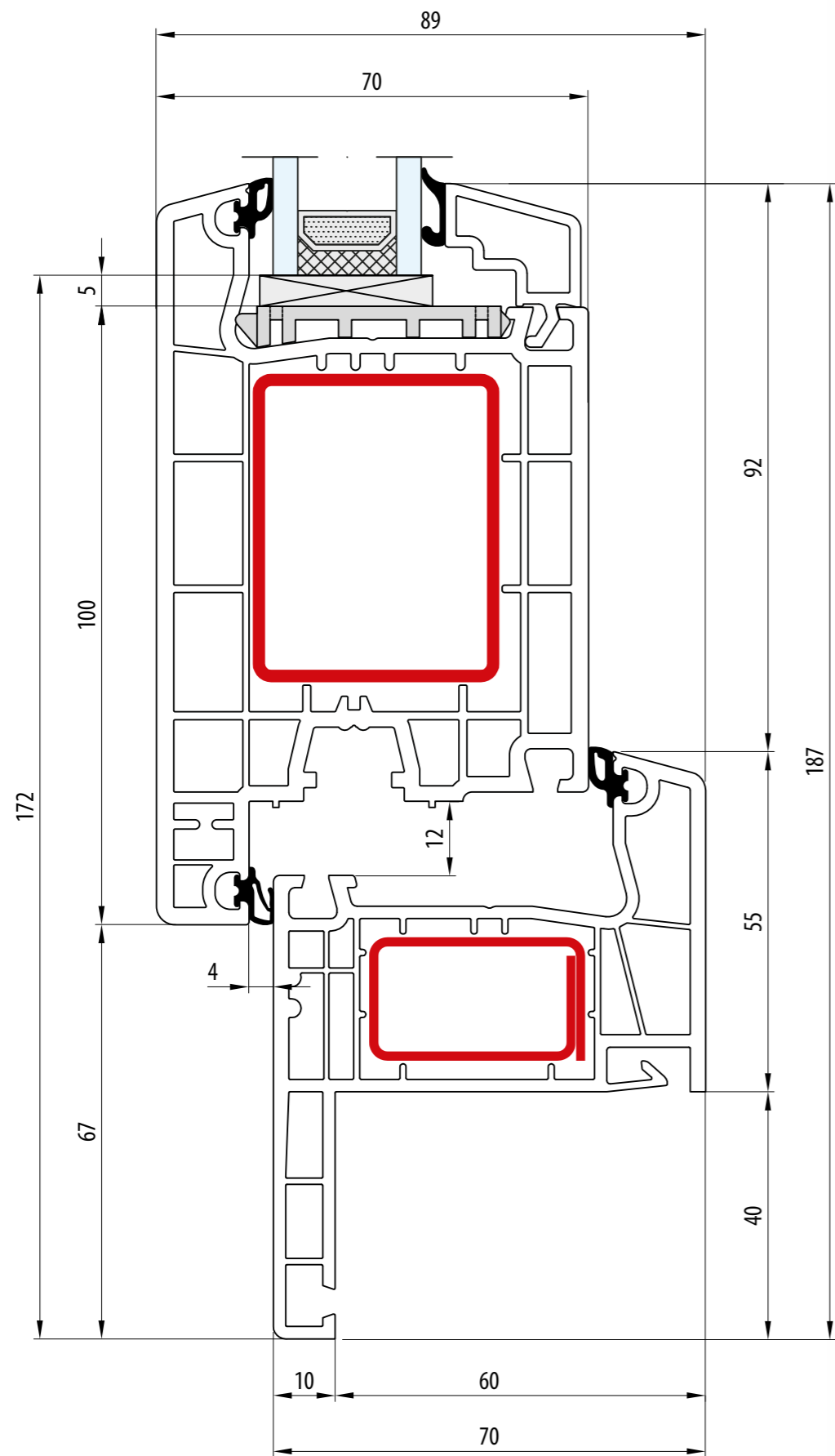

- RENOWACJA - Pletwa: 40 mm · Rama: 55 mm · Skrzydło: 120 mm
- RÉNOVATION - Lip: 40 mm · Dormant: 55 mm · Vantail: 120 mm
- RENOVATION - Strip: 40 mm · Frame: 55 mm · Sash: 120 mm
- RENOVIERUNG - Flosse: 40 mm · Rahmen: 55 mm · Flügel: 120 mm
- RINNOVAZIONE - Aletta da: 40 mm · Telaio: 55 mm · Anta: 120 mm

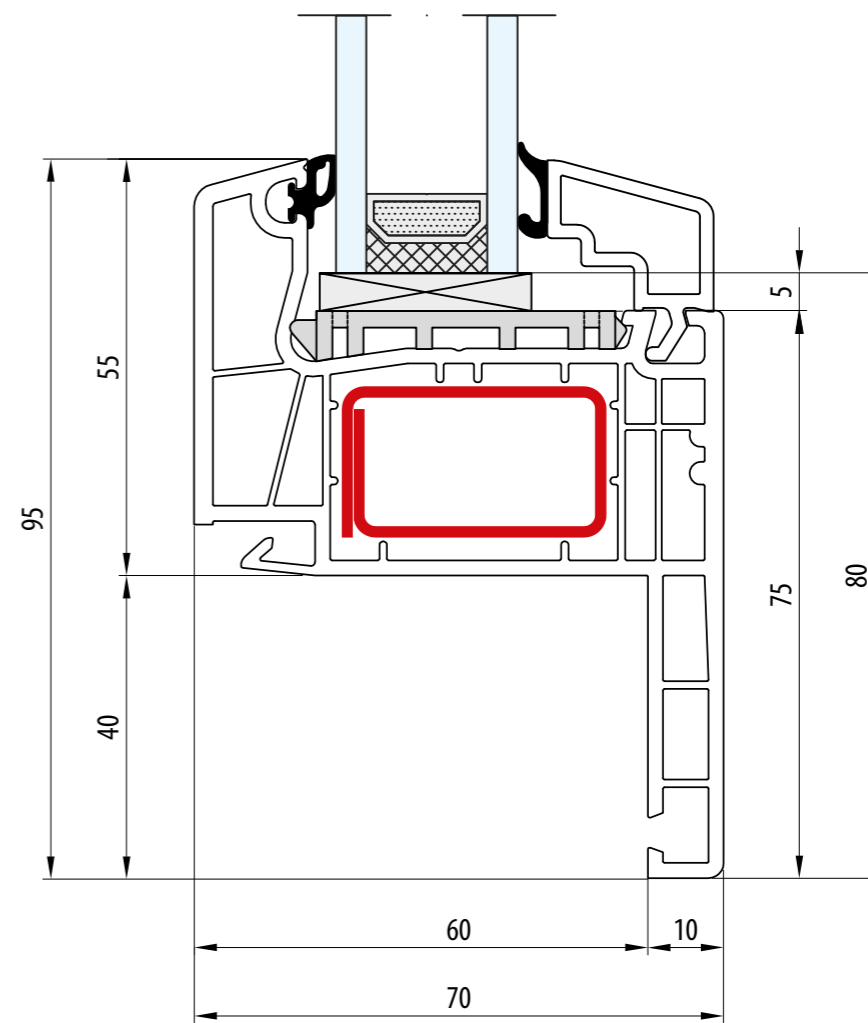
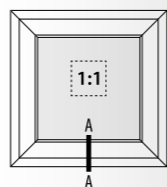

- RENOWACJA - Pletwa: 40 mm · Rama: 55 mm
- RÉNOVATION - Lip: 40 mm · Dormant: 55 mm
- RENOVATION - Strip: 40 mm · Frame: 55 mm
- RENOVIERUNG - Flosse: 40 mm · Rahmen: 55 mm
- RINNOVAZIONE - Aletta da: 40 mm · Telaio: 55 mm

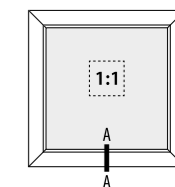

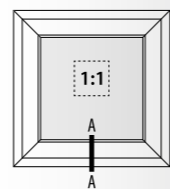
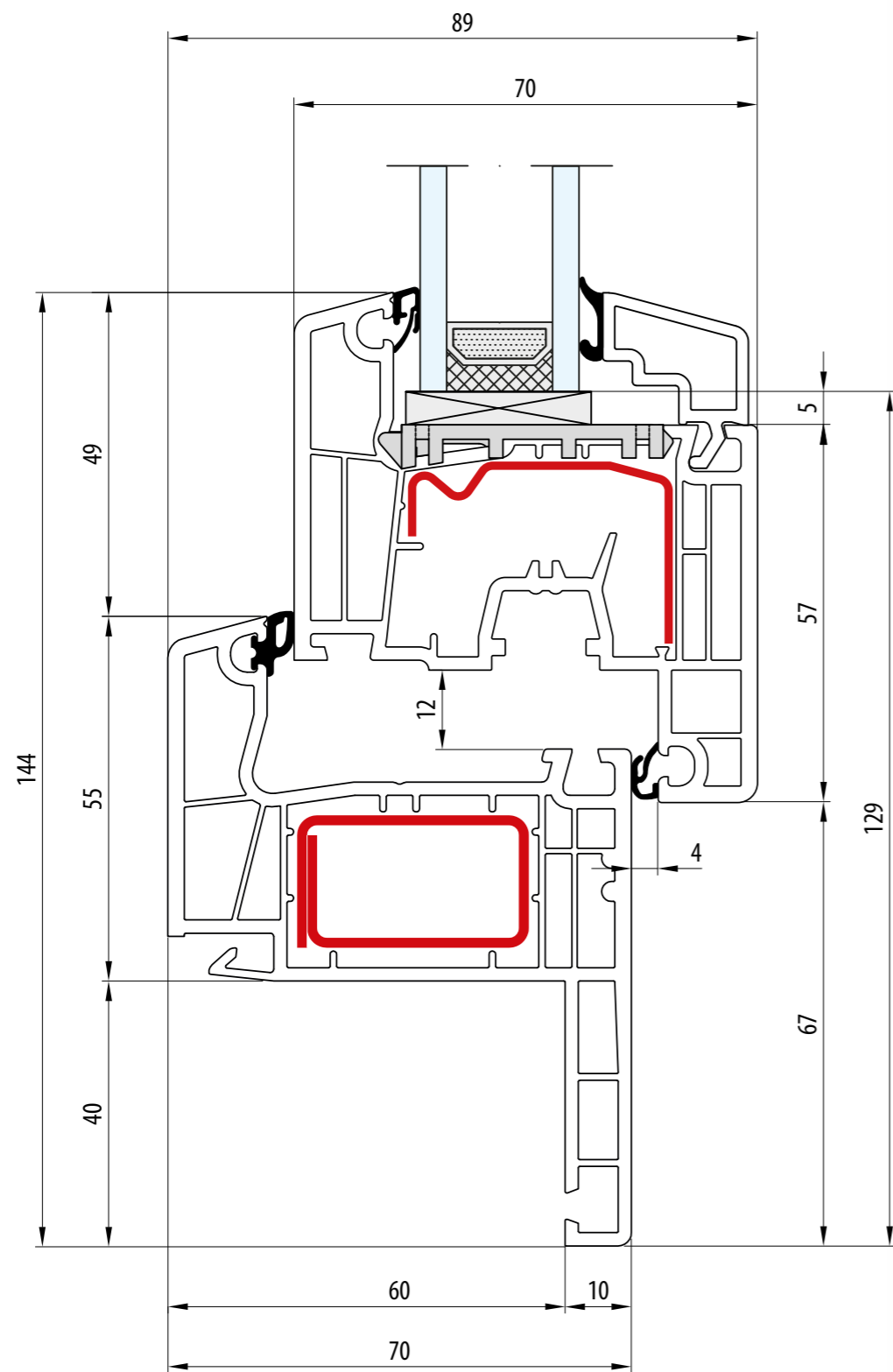

- RENOWACJA - Pletwa: 40 mm · Rama: 55 mm · Skrzydło: 77 mm
- RÉNOVATION - Lip: 40 mm · Dormant: 55 mm · Vantail: 77 mm
- RENOVATION - Strip: 40 mm · Frame: 55 mm · Sash: 77 mm
- RENOVIERUNG - Flosse: 40 mm · Rahmen: 55 mm · Flügel: 77 mm
- RINNOVAZIONE - Aletta da: 40 mm · Telaio: 55 mm · Anta: 77 mm

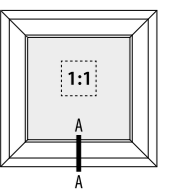
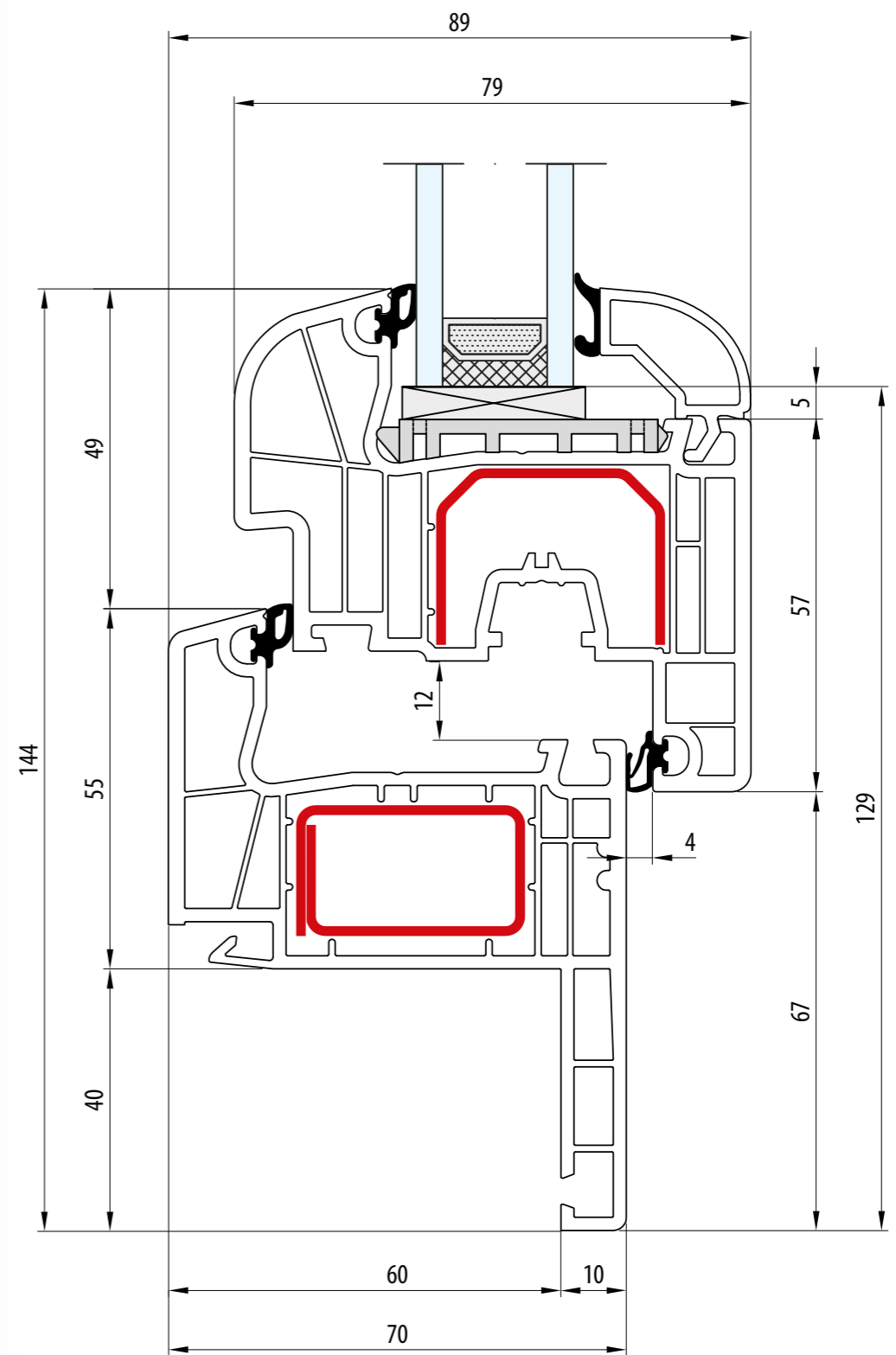

- RENOWACJA - Pletwa: 40 mm · Rama: 55 mm · Skrzydło: 77 mm
- RÉNOVATION - Lip: 40 mm · Dormant: 55 mm · Vantail: 77 mm
- RENOVATION - Strip: 40 mm · Frame: 55 mm · Sash: 77 mm
- RENOVIERUNG - Flosse: 40 mm · Rahmen: 55 mm · Flügel: 77 mm
- RINNOVAZIONE - Aletta da: 40 mm · Telaio: 55 mm · Anta: 77 mm

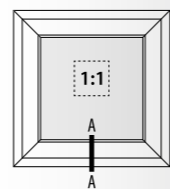
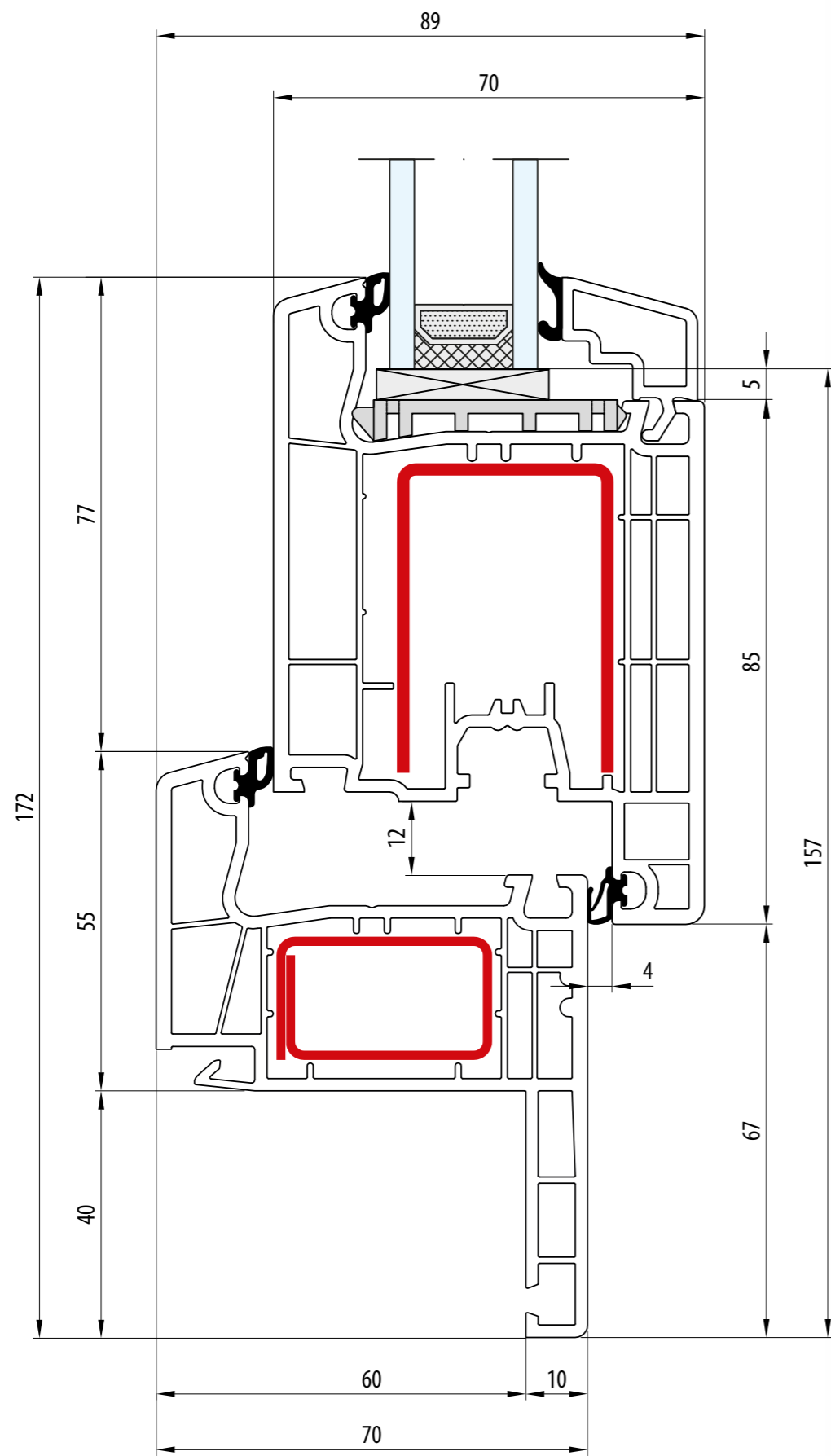

- RENOWACJA - Pletwa: 40 mm · Rama: 55 mm · Skrzydło: 105 mm
- RÉNOVATION - Lip: 40 mm · Dormant: 55 mm · Vantail: 105 mm
- RENOVATION - Strip: 40 mm · Frame: 55 mm · Sash: 105 mm
- RENOVIERUNG - Flosse: 40 mm · Rahmen: 55 mm · Flügel: 105 mm
- RINNOVAZIONE - Aletta da: 40 mm · Telaio: 55 mm · Anta: 105 mm

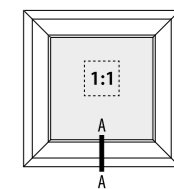
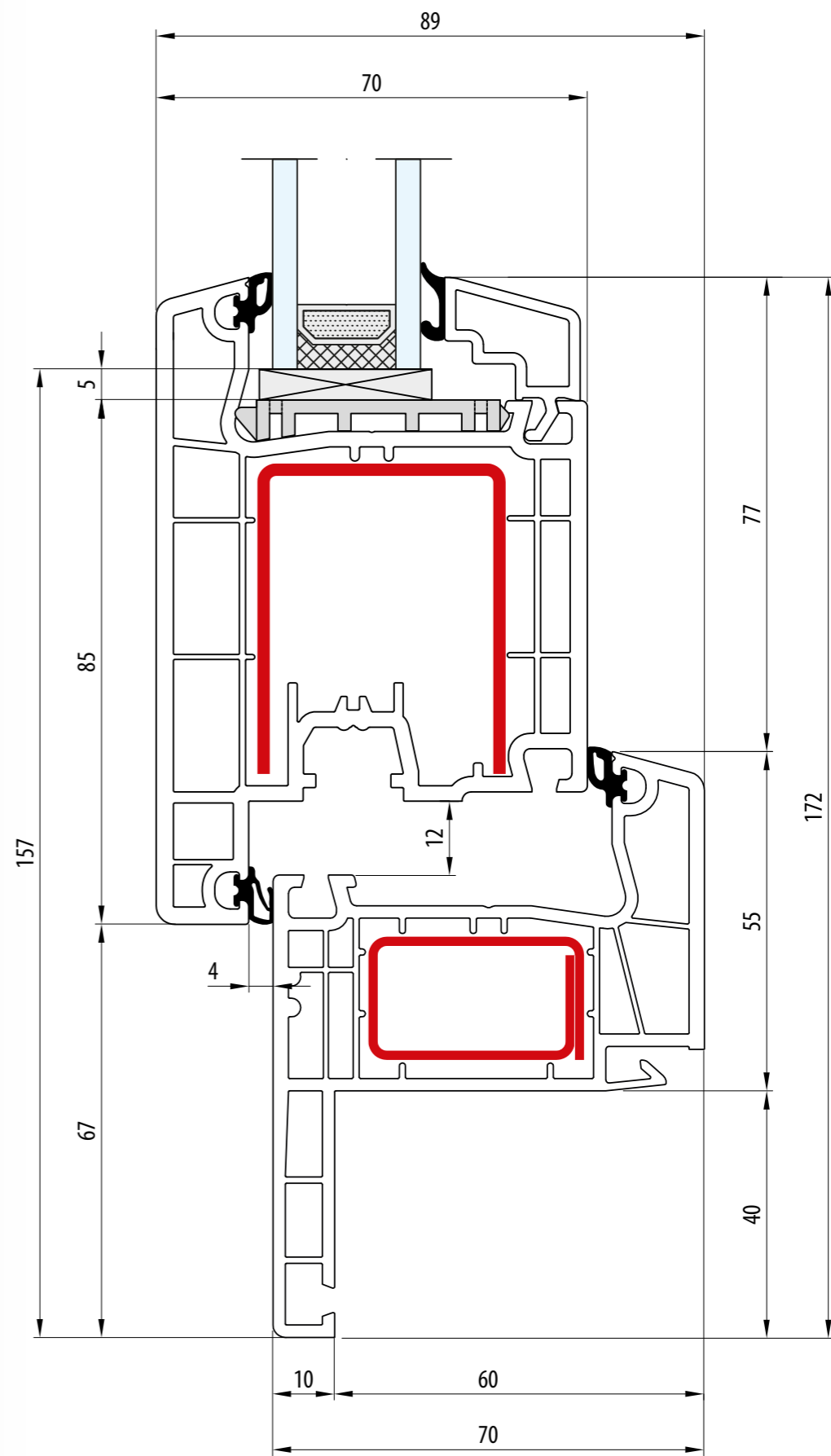

- RENOWACJA - Pletwa: 40 mm · Rama: 55 mm · Skrzydło: 105 mm
- RÉNOVATION - Lip: 40 mm · Dormant: 55 mm · Vantail: 105 mm
- RENOVATION - Strip: 40 mm · Frame: 55 mm · Sash: 105 mm
- RENOVIERUNG - Flosse: 40 mm · Rahmen: 55 mm · Flügel: 105 mm
- RINNOVAZIONE - Aletta da: 40 mm · Telaio: 55 mm · Anta: 105 mm

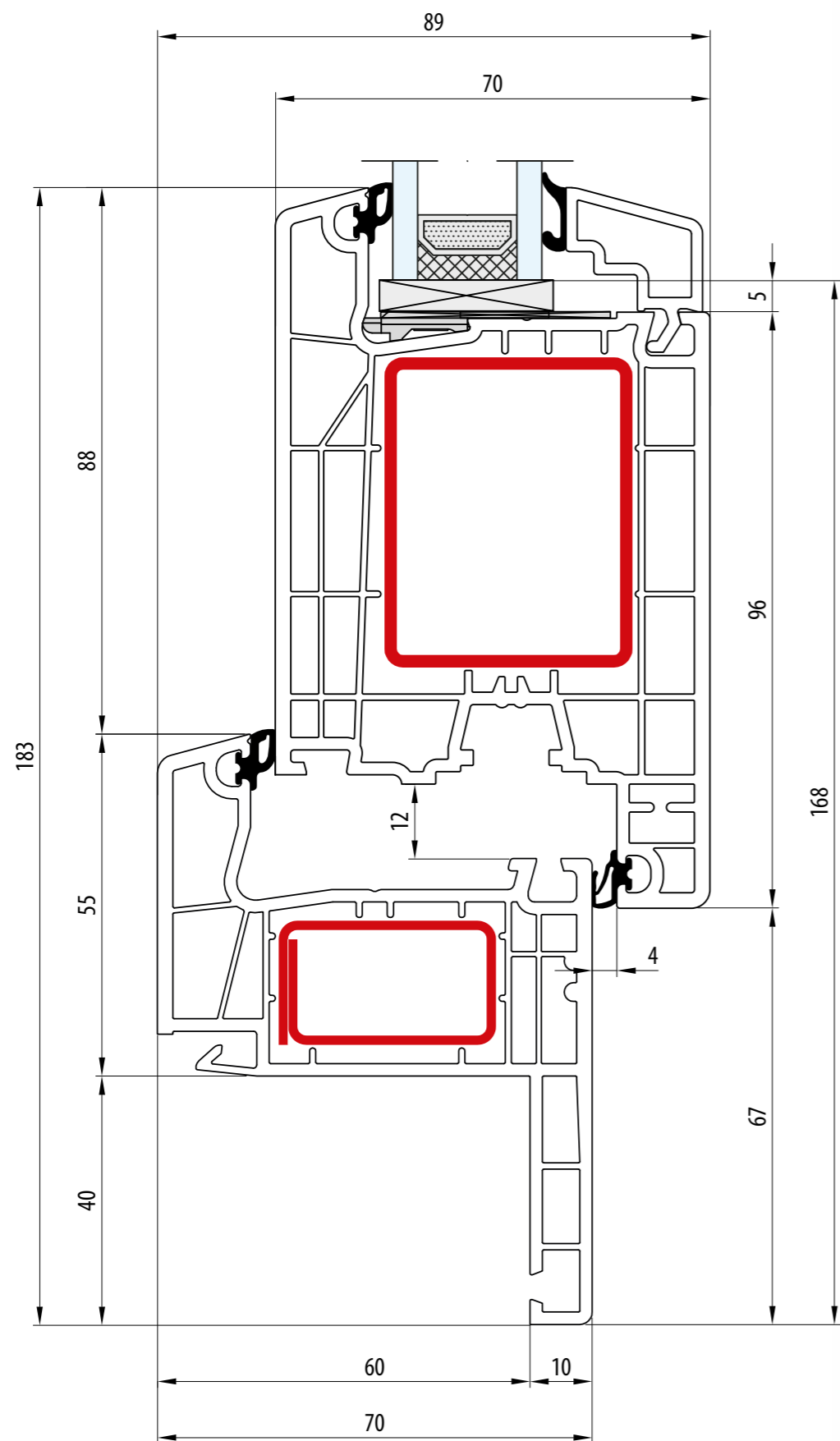

- RENOwACJA - Pletwa: 40 mm · Rama: 55 mm · Skrzydło: 116 mm
- RÉNOVATION - Lip: 40 mm · Dormant: 55 mm · Vantail: 116 mm
- RENOVATION - Strip: 40 mm · Frame: 55 mm · Sash: 116 mm
- RENOVIERUNG - Flosse: 40 mm · Rahmen: 55 mm · Flügel: 116 mm
- RINNOVAZIONE - Aletta da: 40 mm · Telaio: 55 mm · Anta: 116 mm

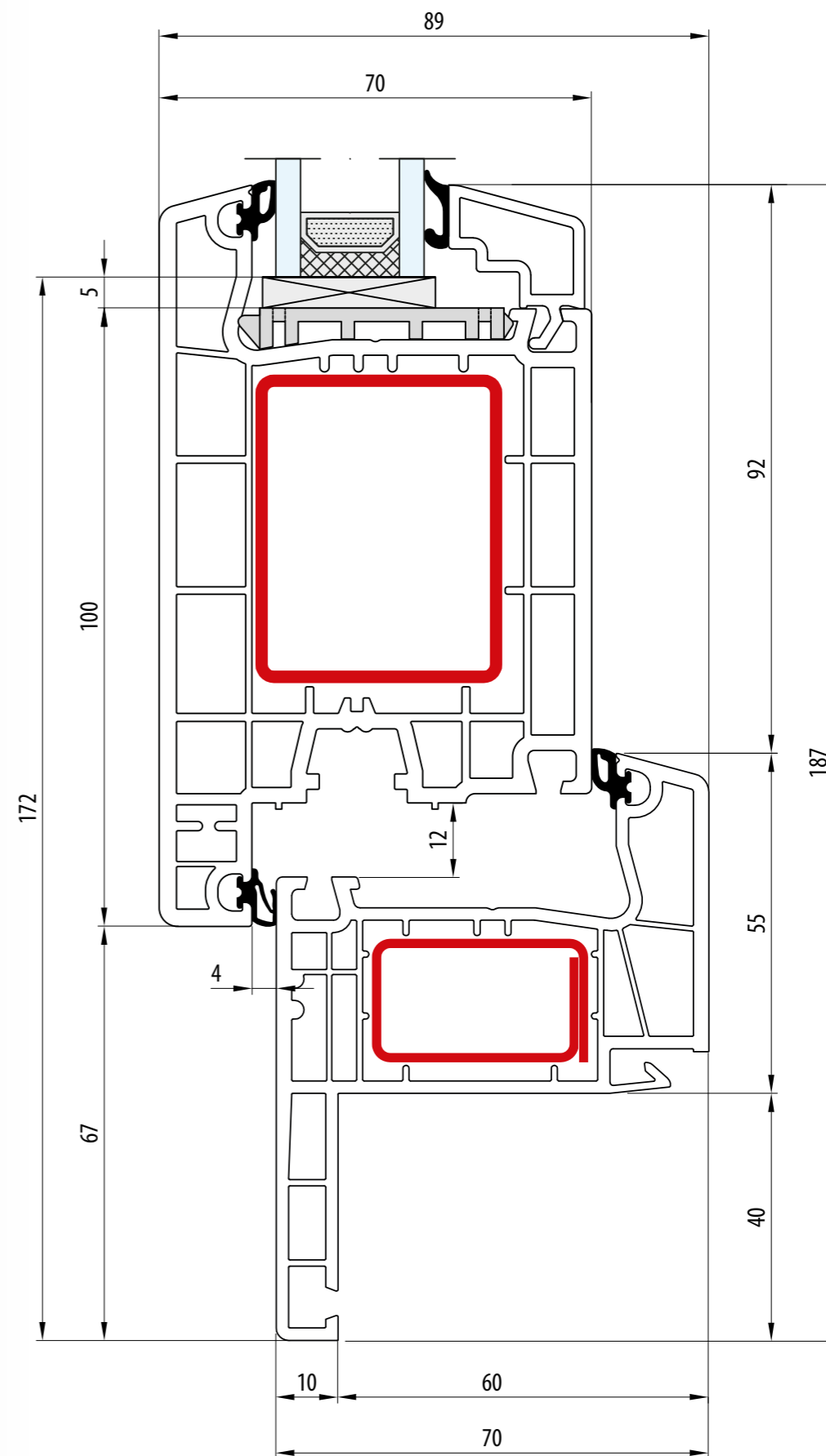
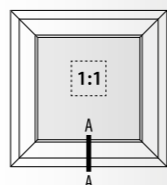

- RENOwACJA - Pletwa: 40 mm · Rama: 55 mm · Skrzydło: 120 mm
- RÉNOVATION - Lip: 40 mm · Dormant: 55 mm · Vantail: 120 mm
- RENOVATION - Strip: 40 mm · Frame: 55 mm · Sash: 120 mm
- RENOVIERUNG - Flosse: 40 mm · Rahmen: 55 mm · Flügel: 120 mm
- RINNOVAZIONE - Aletta da: 40 mm · Telaio: 55 mm · Anta: 120 mm

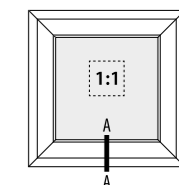

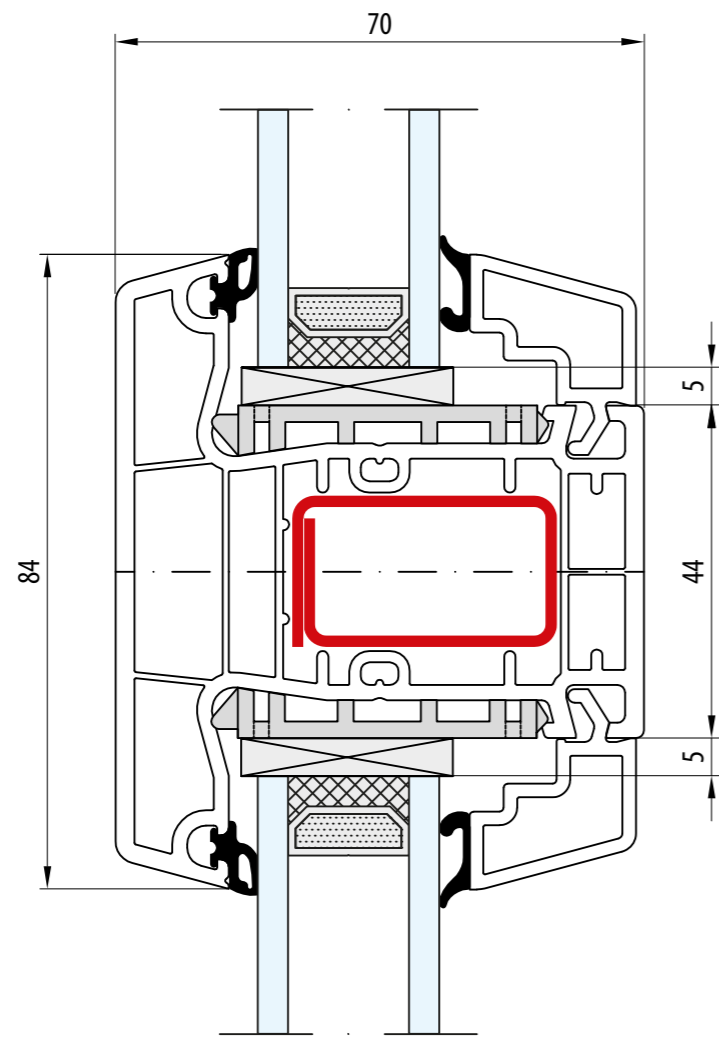

- Słupek stalowy: 84 mm
- Meneau fixe: 84 mm
- Fix post: 84 mm
- Festem Pfahl: 84 mm
- Montante fisso: 84 mm

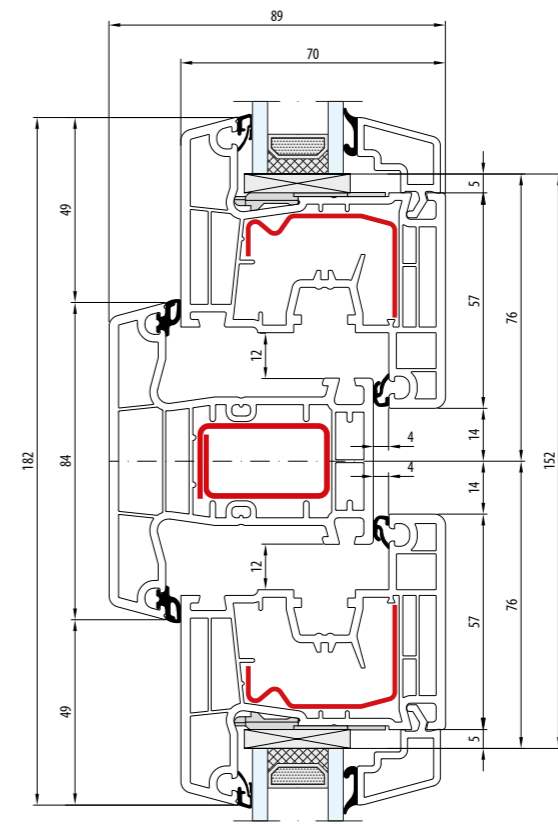
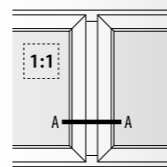

- Słupek stalowy: 84 mm · Skrzydło: 77 mm
- Meneau fixe: 84 mm · Vantail: 77 mm
- Fix post: 84 mm · Sash: 77 mm
- Festem Pfahl: 84 mm · Flügel: 77 mm
- Montante fisso: 84 mm · Anta: 77 mm

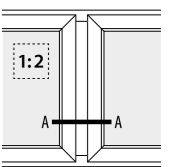

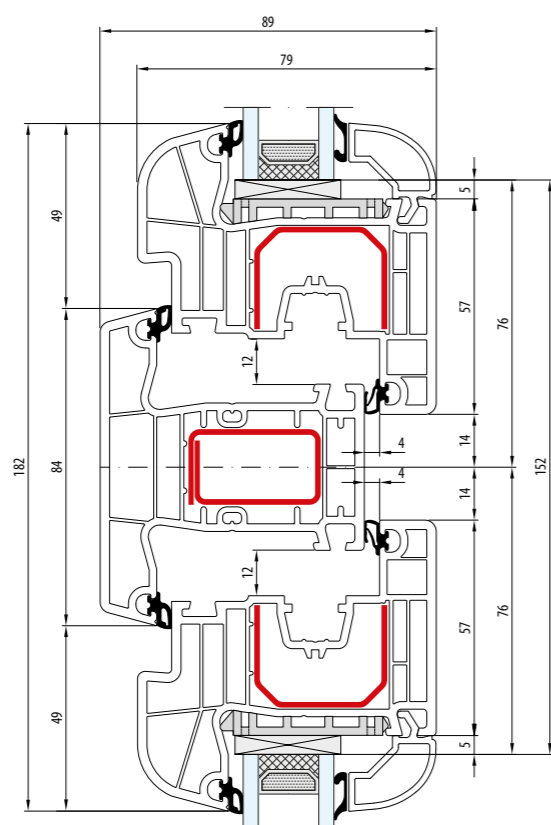



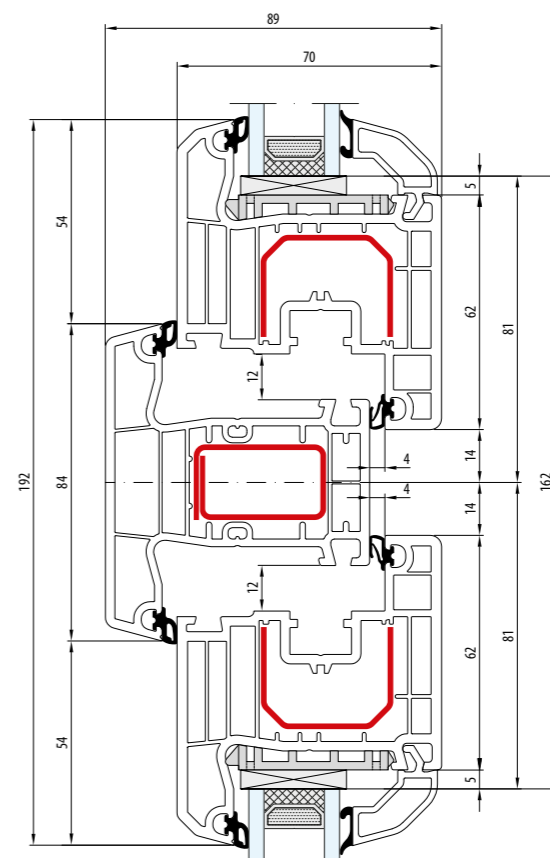
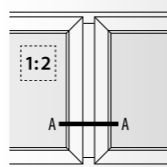

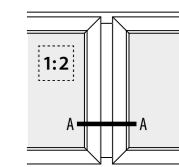

- Słupek stalowy: 84 mm · Skrzydło: 77 mm
- Meneau fixe: 84 mm · Vantail: 77 mm
- Fix post: 84 mm · Sash: 77 mm
- Festem Pfahl: 84 mm · Flügel: 77 mm
- Montante fisso: 84 mm · Anta: 77 mm

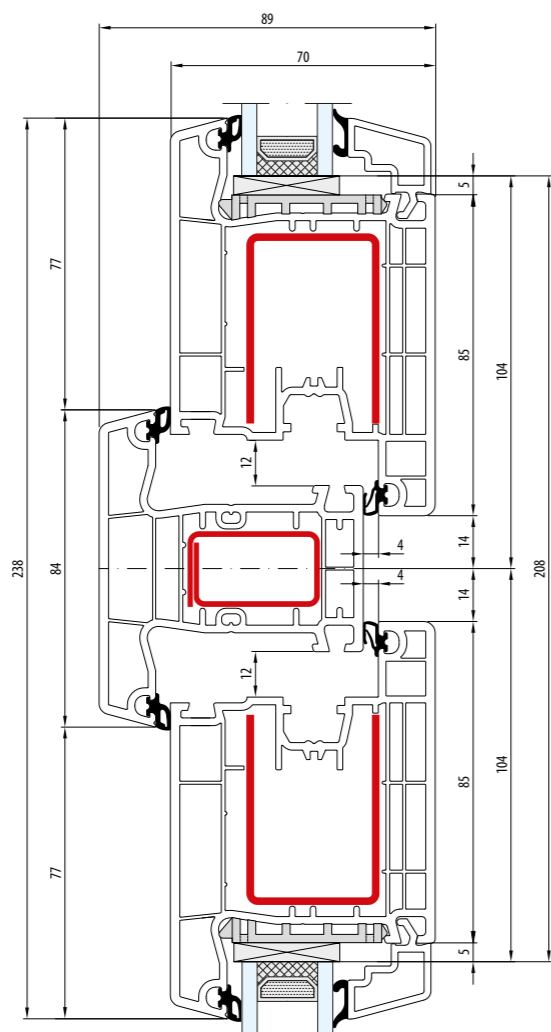





- Słupek stalowy: 84 mm · Skrzydło: 82 mm
- Meneau fixe: 84 mm · Vantail: 82 mm
- Fix post: 84 mm · Sash: 82 mm
- Festem Pfahl: 84 mm · Flügel: 82 mm
- Montante fisso: 84 mm · Anta: 82 mm



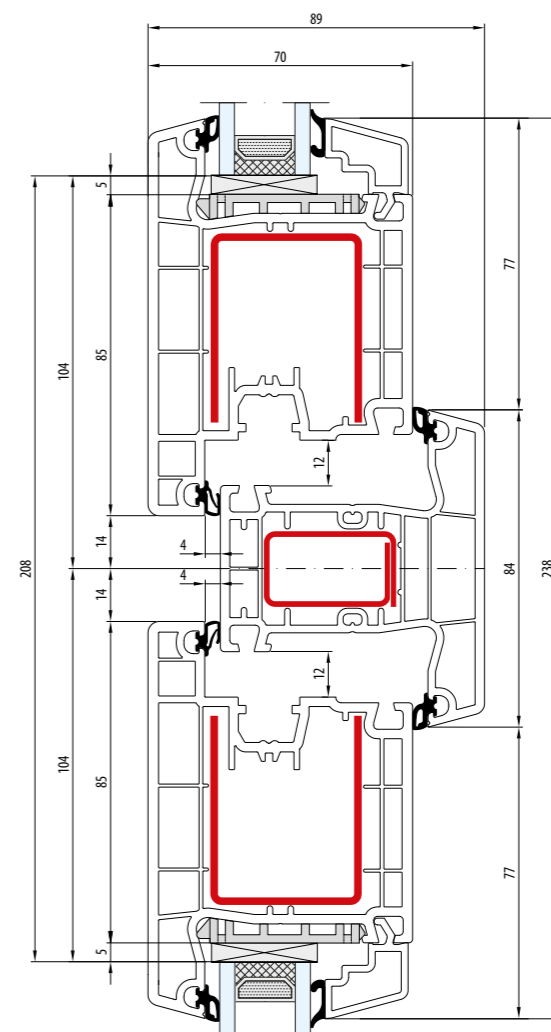
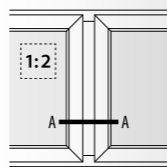

-  Słupek stalowy: 84 mm · Skrzydło: 105 mm
-  Meneau fixe: 84 mm · Vantail: 105 mm
-  Fix post: 84 mm · Sash: 105 mm
-  Festem Pfahl: 84 mm · Flügel: 105 mm
-  Montante fisso: 84 mm · Anta: 105 mm



-  Słupek stalowy: 84 mm · Skrzydło: 105 mm
-  Meneau fixe: 84 mm · Vantail: 105 mm
-  Fix post: 84 mm · Sash: 105 mm
-  Festem Pfahl: 84 mm · Flügel: 105 mm
-  Montante fisso: 84 mm · Anta: 105 mm

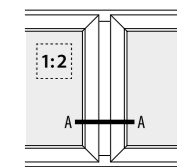

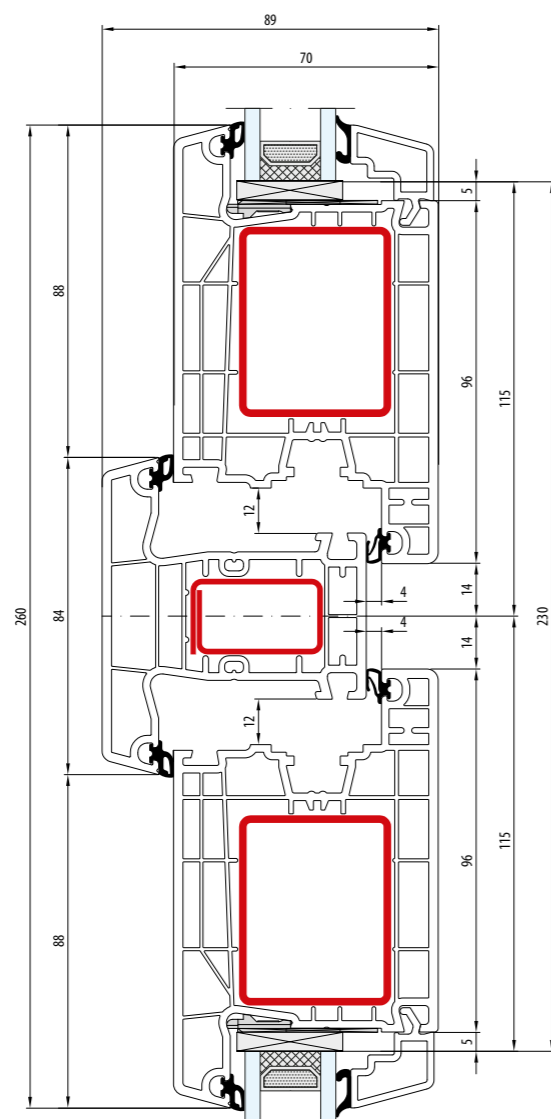

- Słupek stalowy: 84 mm · Skrzydło: 116 mm
- Meneau fixe: 84 mm · Vantail: 116 mm
- Fix post: 84 mm · Sash: 116 mm
- Festem Pfahl: 84 mm · Flügel: 116 mm
- Montante fisso: 84 mm · Anta: 116 mm

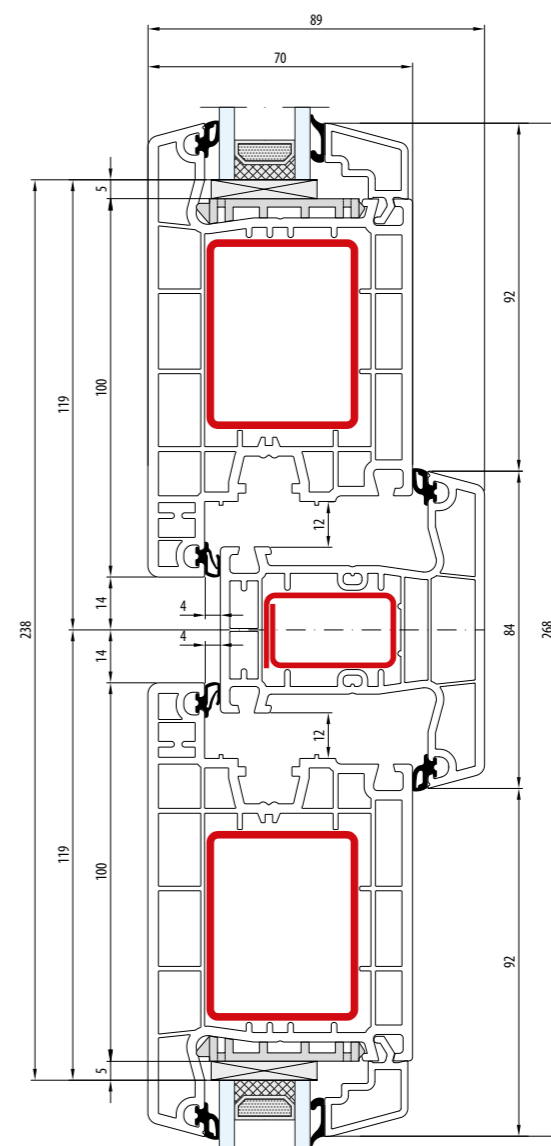
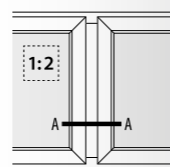

- Słupek stalowy: 84 mm · Skrzydło: 120 mm
- Meneau fixe: 84 mm · Vantail: 120 mm
- Fix post: 84 mm · Sash: 120 mm
- Festem Pfahl: 84 mm · Flügel: 120 mm
- Montante fisso: 84 mm · Anta: 120 mm

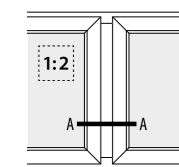

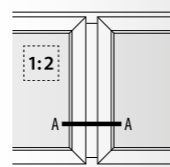
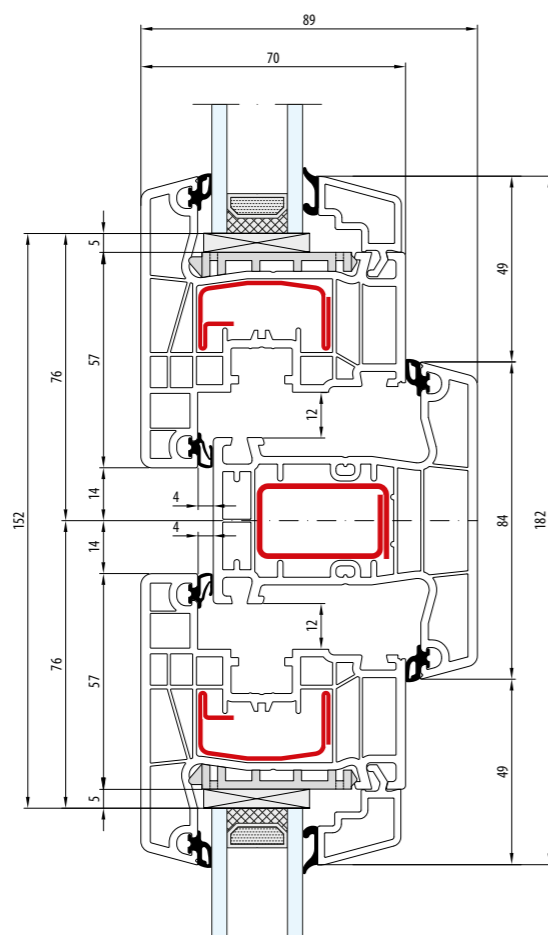

- Słupek stalowy: 84 mm · Skrzydło: 77 mm
- Meneau fixe: 84 mm · Vantail: 77 mm
- Fix post: 84 mm · Sash: 77 mm
- Festem Pfahl: 84 mm · Flügel: 77 mm
- Montante fisso: 84 mm · Anta: 77 mm

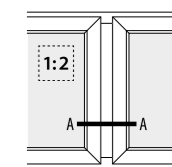
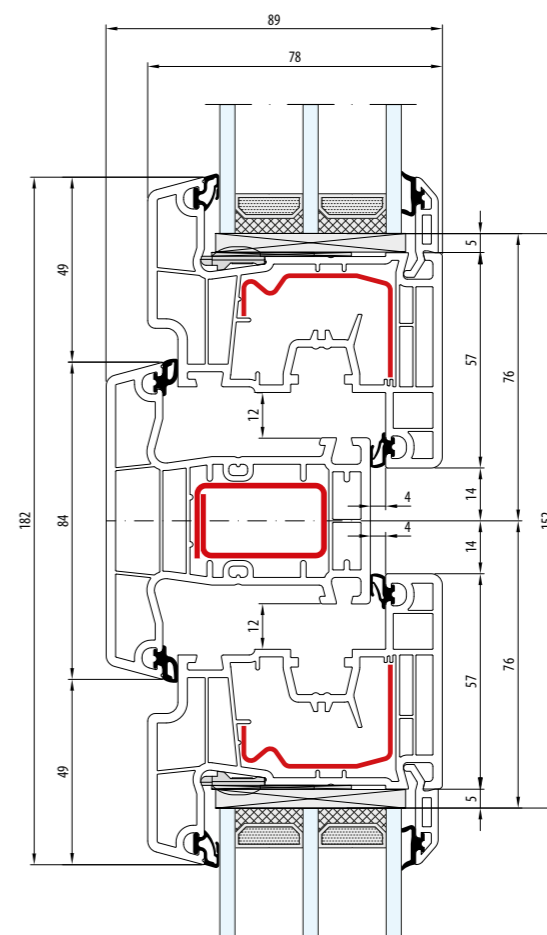

- Słupek stalowy: 84 mm · Skrzydło: 77 mm
- Meneau fixe: 84 mm · Vantail: 77 mm
- Fix post: 84 mm · Sash: 77 mm
- Festem Pfahl: 84 mm · Flügel: 77 mm
- Montante fisso: 84 mm · Anta: 77 mm

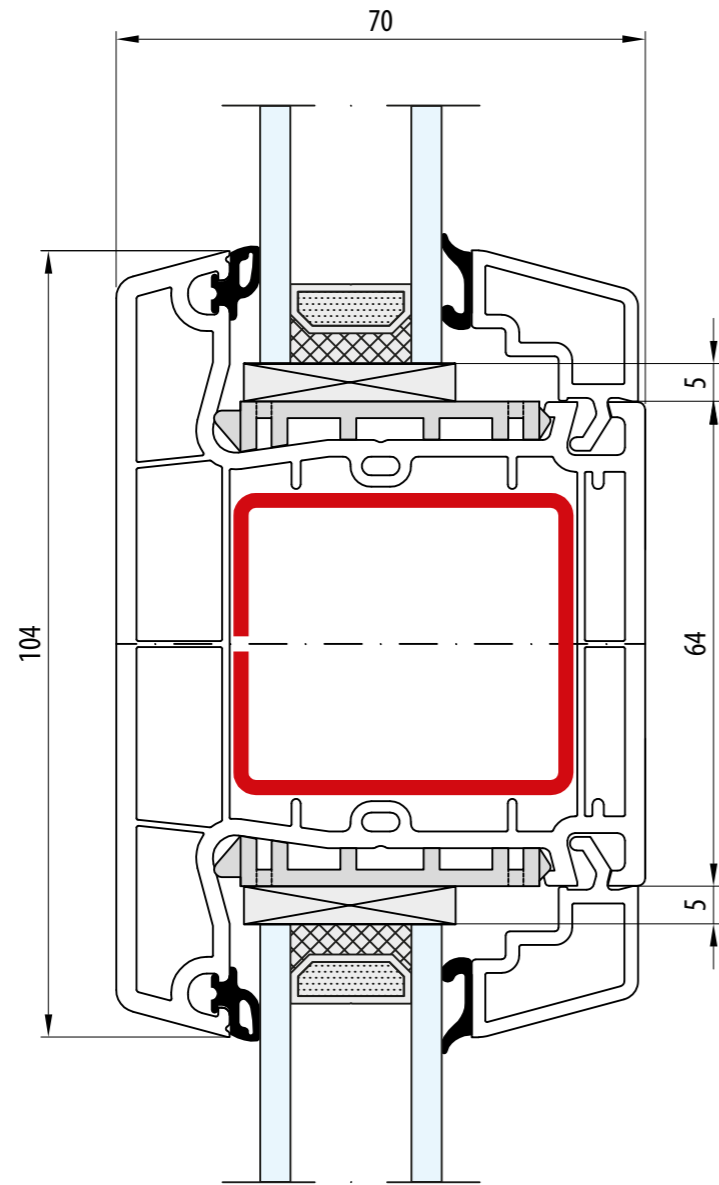

- Słupek stalowy: 104 mm
- Meneau fixe: 104 mm
- Fix post: 104 mm
- Festem Pfahl: 104 mm
- Montante fisso: 104 mm

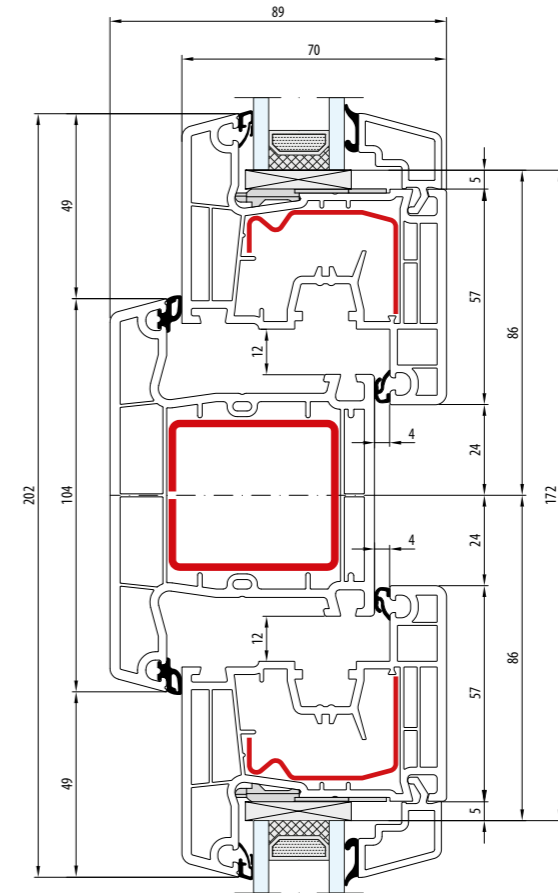
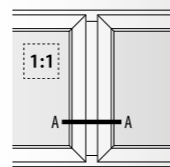

- Słupek stalowy: 104 mm · Skrzydło: 77 mm
- Meneau fixe: 104 mm · Vantail: 77 mm
- Fix post: 104 mm · Sash: 77 mm
- Festem Pfahl: 104 mm · Flügel: 77 mm
- Montante fisso: 104 mm · Anta: 77 mm

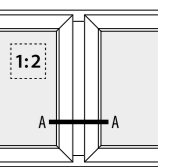

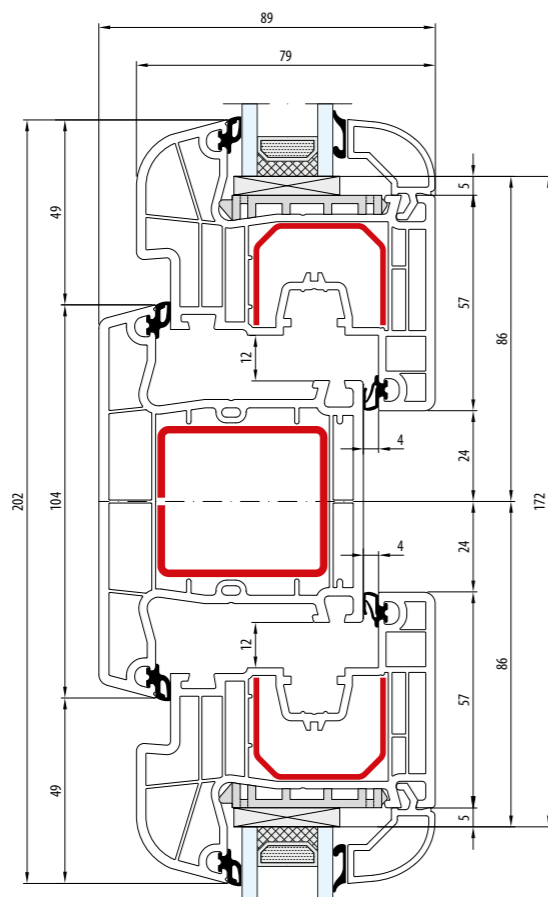

- Słupek stały: 104 mm · Skrzydło: 77 mm
- Meneau fixe: 104 mm · Vantail: 77 mm
- Fix post: 104 mm · Sash: 77 mm
- Festem Pfahl: 104 mm · Flügel: 77 mm
- Montante fisso: 104 mm · Anta: 77 mm

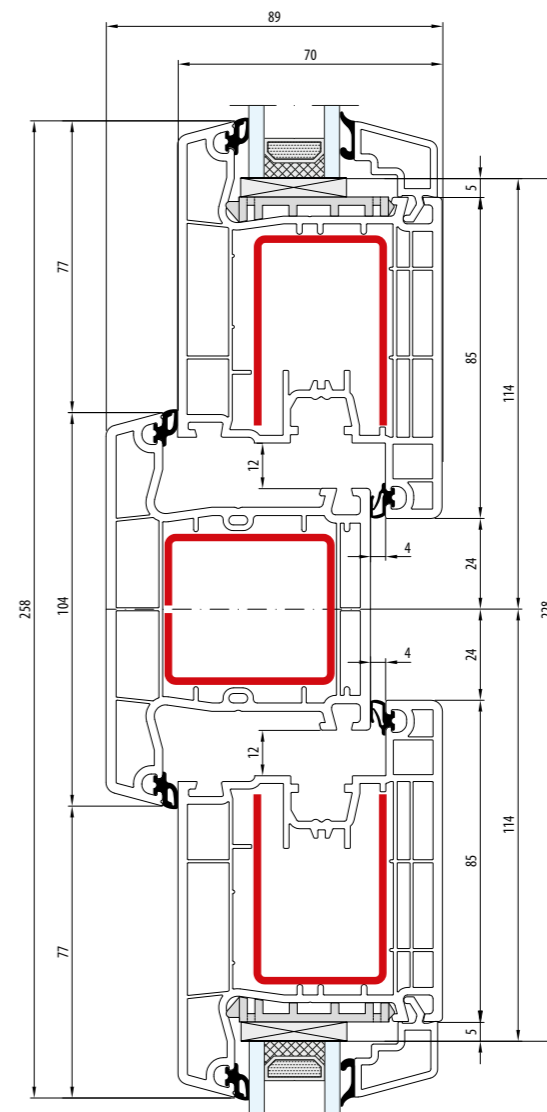
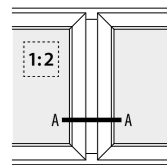
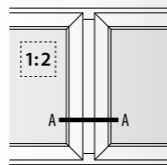

- Słupek stały: 104 mm · Skrzydło: 105 mm
- Meneau fixe: 104 mm · Vantail: 105 mm
- Fix post: 104 mm · Sash: 105 mm
- Festem Pfahl: 104 mm · Flügel: 105 mm
- Montante fisso: 104 mm · Anta: 105 mm

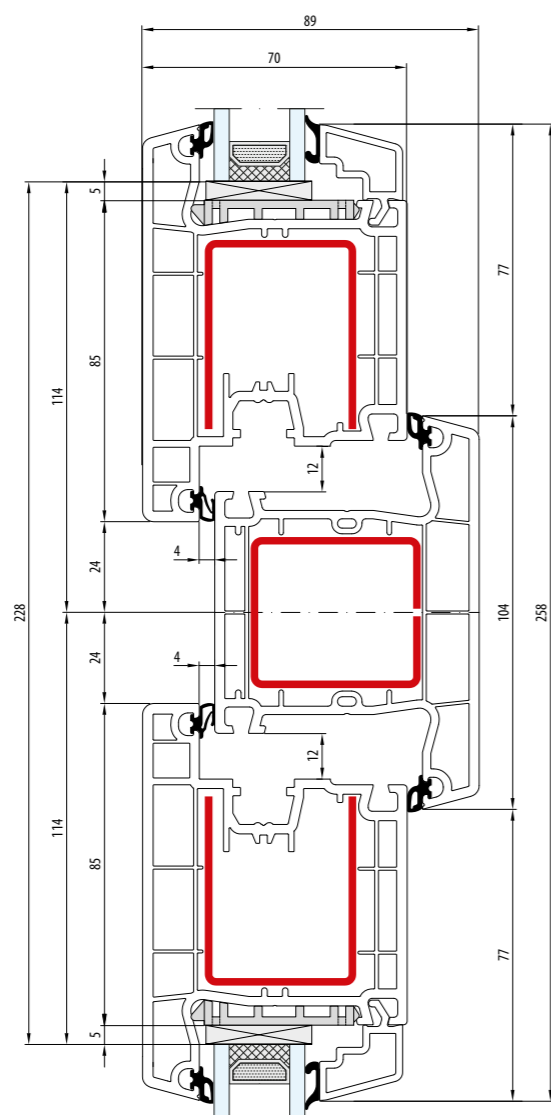

- Słupek stały: 104 mm · Skrzydło: 105 mm
- Meneau fixe: 104 mm · Vantail: 105 mm
- Fix post: 104 mm · Sash: 105 mm
- Festem Pfahl: 104 mm · Flügel: 105 mm
- Montante fisso: 104 mm · Anta: 105 mm

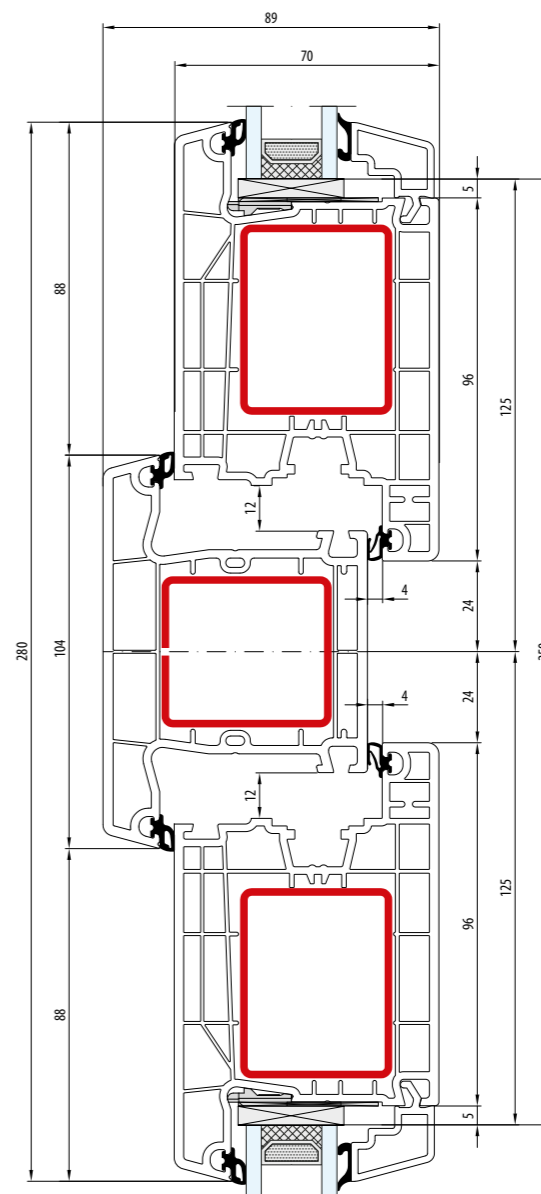
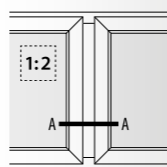

- Słupek stały: 104 mm · Skrzydło: 116 mm
- Meneau fixe: 104 mm · Vantail: 116 mm
- Fix post: 104 mm · Sash: 116 mm
- Festem Pfahl: 104 mm · Flügel: 116 mm
- Montante fisso: 104 mm · Anta: 116 mm

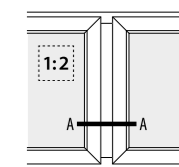

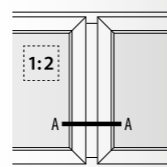
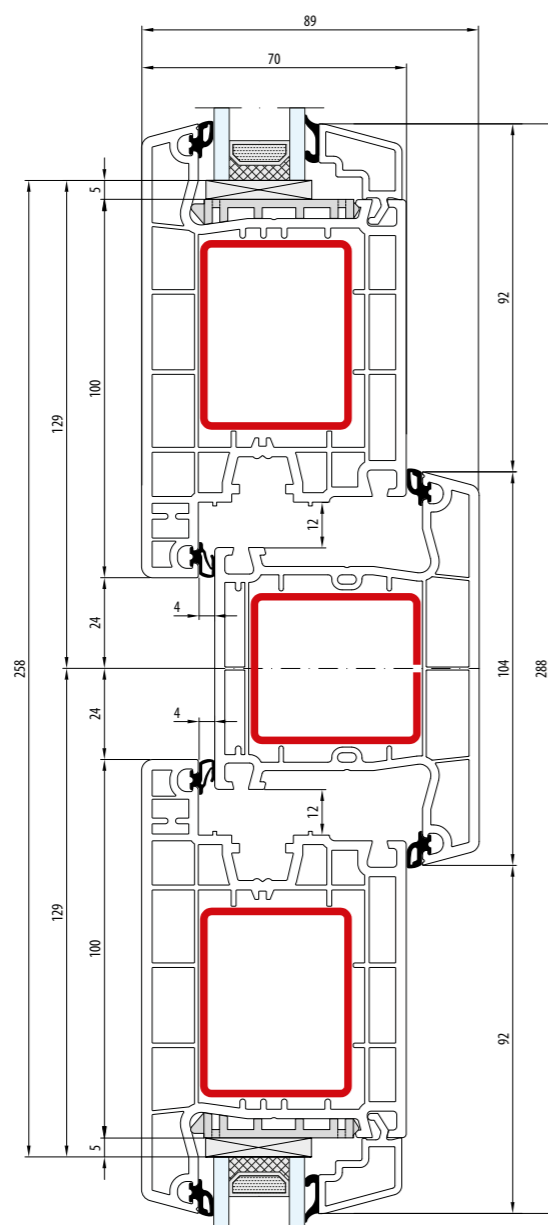

- Słupek stały: 104 mm · Skrzydło: 120 mm
- Meneau fixe: 104 mm · Vantail: 120 mm
- Fix post: 104 mm · Sash: 120 mm
- Festem Pfahl: 104 mm · Flügel: 120 mm
- Montante fissa: 104 mm · Anta: 120 mm

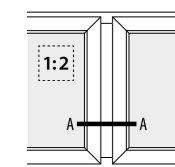
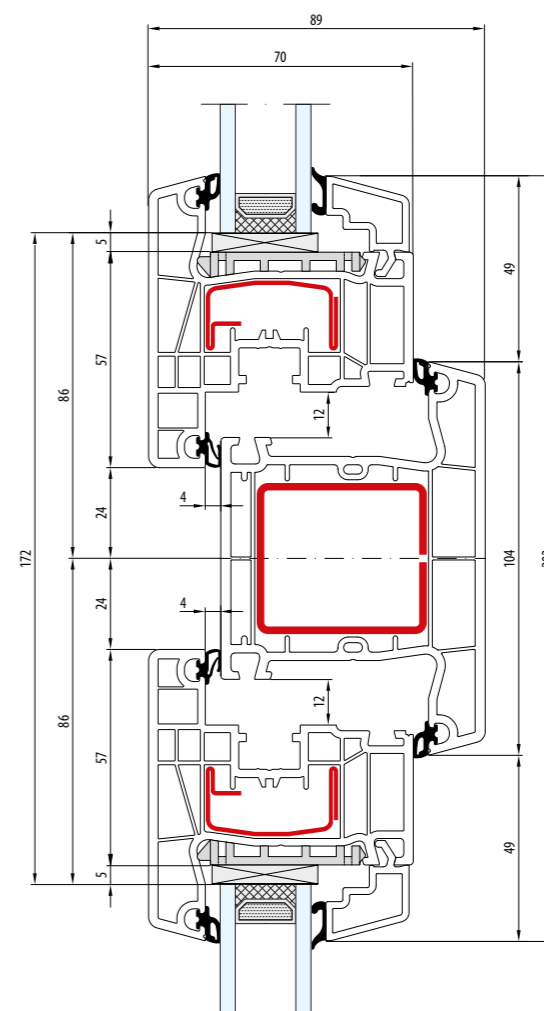

- Słupek stały: 104 mm · Skrzydło: 77 mm
- Meneau fixe: 104 mm · Vantail: 77 mm
- Fix post: 104 mm · Sash: 77 mm
- Festem Pfahl: 104 mm · Flügel: 77 mm
- Montante fissa: 104 mm · Anta: 77 mm

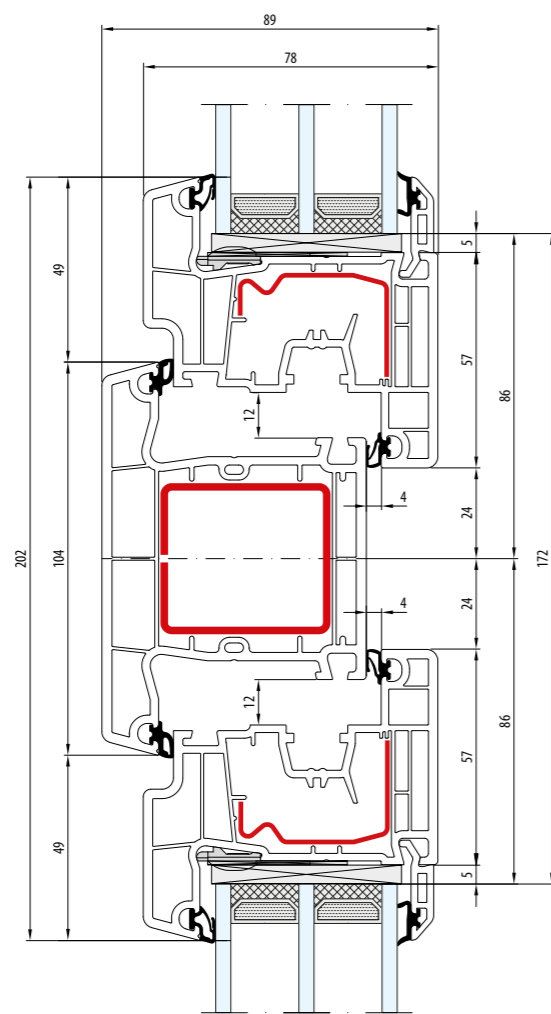

- Słupek stały: 104 mm · Skrzydło: 77 mm
- Meneau fixe: 104 mm · Vantail: 77 mm
- Fix post: 104 mm · Sash: 77 mm
- Festem Pfahl: 104 mm · Flügel: 77 mm
- Montante fisso: 104 mm · Anta: 77 mm

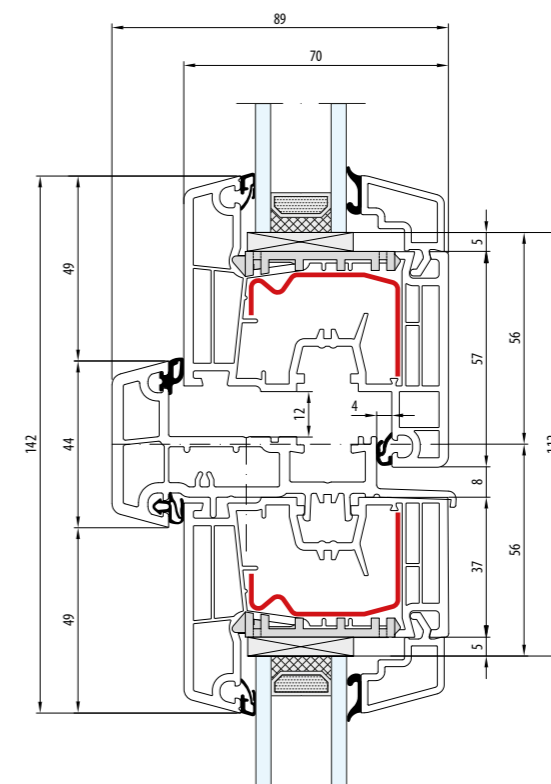
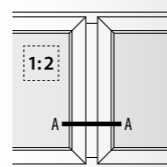

- Słupek ruchomy: 44 mm · Skrzydło: 77 mm / 57 mm
- Meneau mobile: 44 mm · Vantail: 77 mm / 57 mm
- Movable post: 44 mm · Sash: 77 mm / 57 mm
- Stulp: 44 mm · Flügel: 77 mm / 57 mm
- Montante mobile: 44 mm · Anta: 77 mm / 57 mm

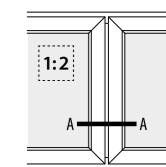

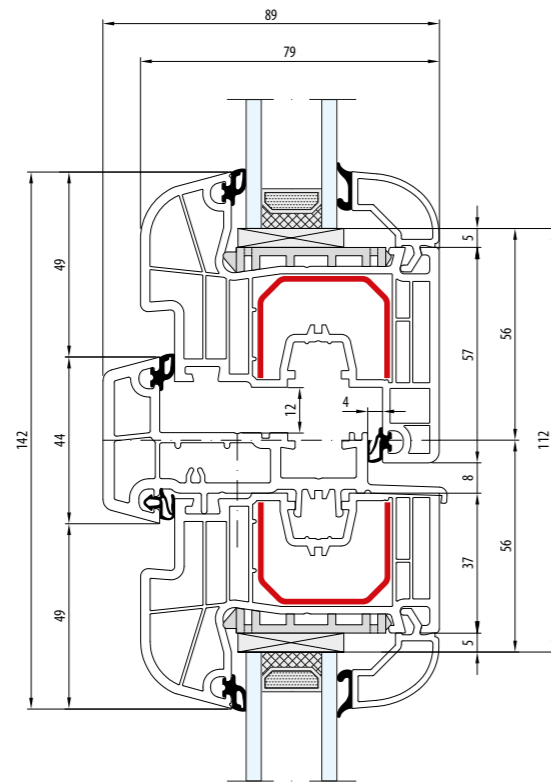

- Słupek ruchomy: 44 mm · Skrzydło: 77 mm / 57 mm
- Meneau mobile: 44 mm · Vantail: 77 mm / 57 mm
- Movable post: 44 mm · Sash: 77 mm / 57 mm
- Stulp: 44 mm · Flügel: 77 mm / 57 mm
- Montante mobile: 44 mm · Anta: 77 mm / 57 mm

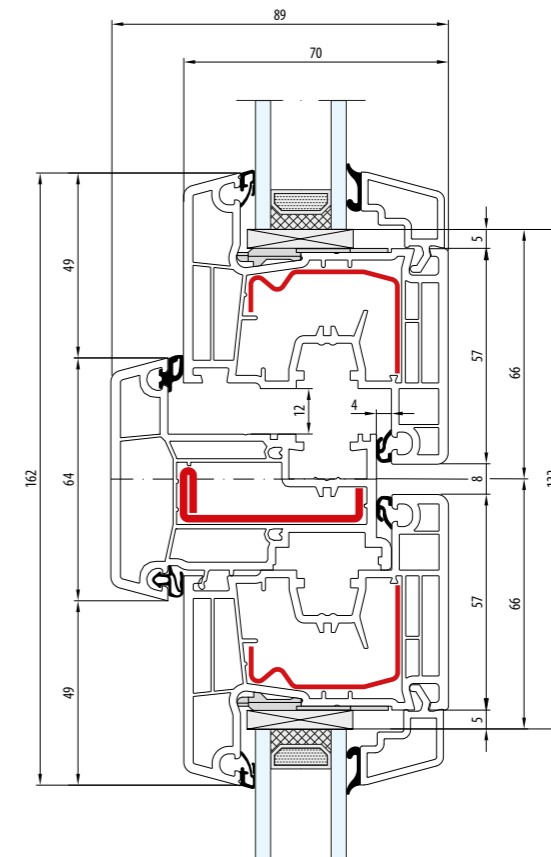
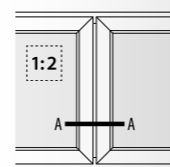

- Słupek ruchomy: 64 mm · Skrzydło: 77 mm
- Meneau mobile: 64 mm · Vantail: 77 mm
- Movable post: 64 mm · Sash: 77 mm
- Stulp: 64 mm · Flügel: 77 mm
- Montante mobile: 64 mm · Anta: 77 mm

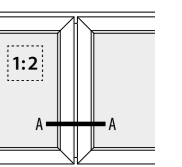

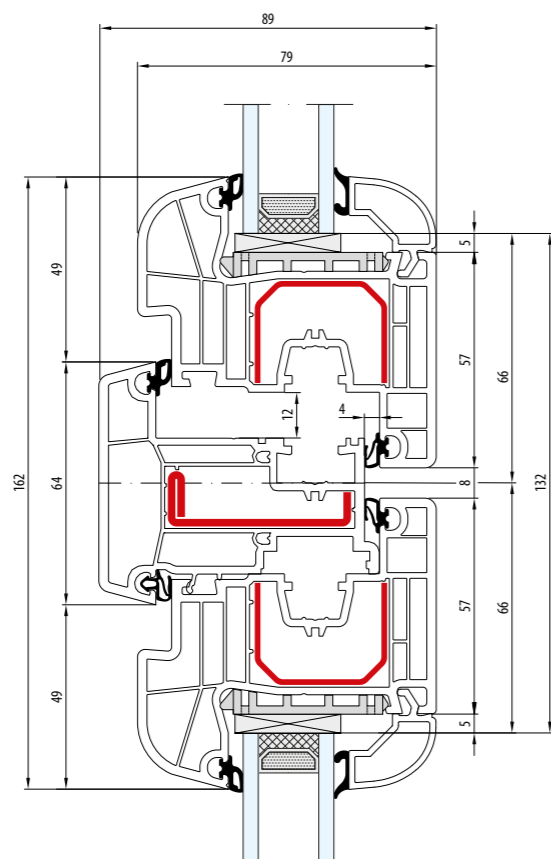

- Słupek ruchomy: 64 mm · Skrzydło: 77 mm
- Meneau mobile: 64 mm · Vantail: 77 mm
- Movable post: 64 mm · Sash: 77 mm
- Stulp: 64 mm · Flügel: 77 mm
- Montante mobile: 64 mm · Anta: 77 mm

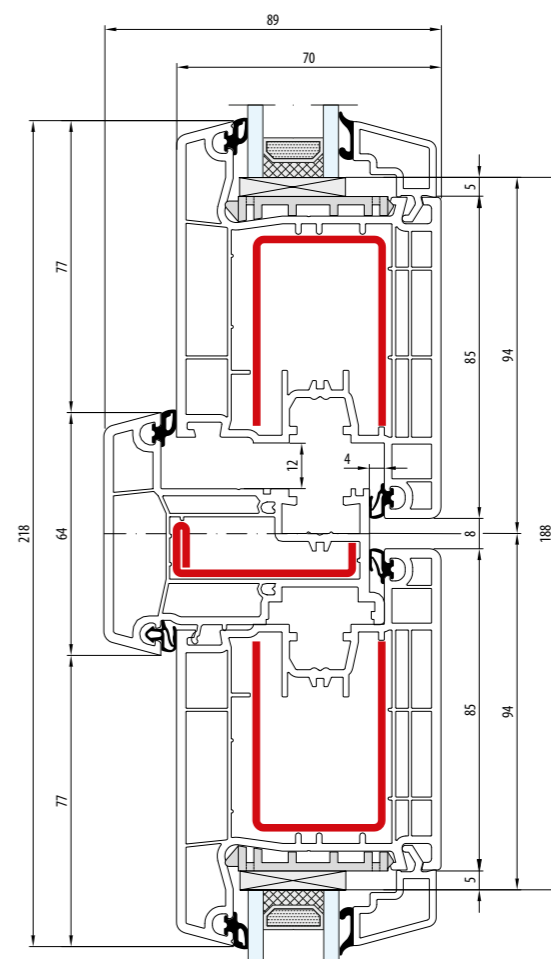
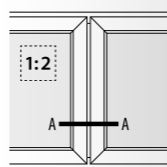

- Słupek ruchomy: 64 mm · Skrzydło: 105 mm
- Meneau mobile: 64 mm · Vantail: 105 mm
- Movable post: 64 mm · Sash: 105 mm
- Stulp: 64 mm · Flügel: 105 mm
- Montante mobile: 64 mm · Anta: 105 mm

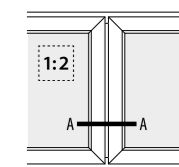

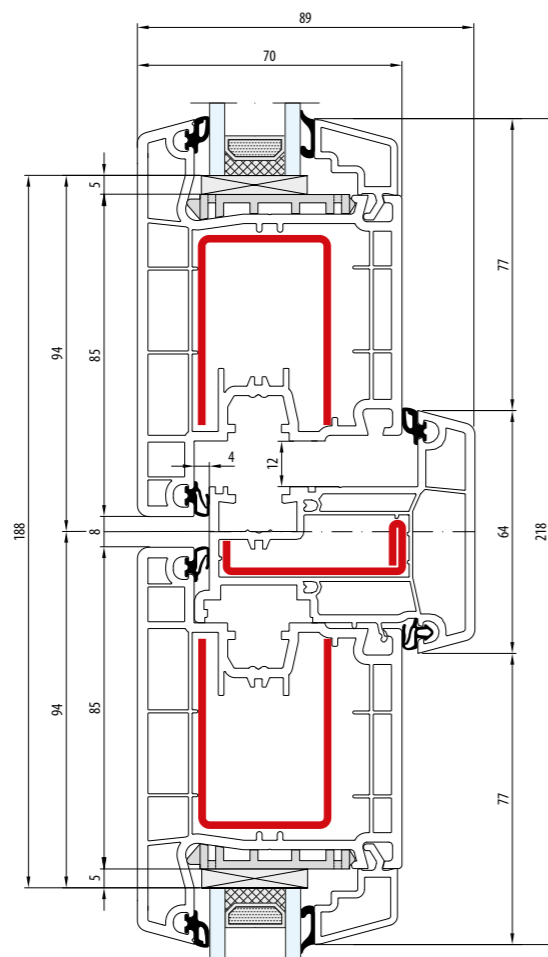

- Słupek ruchomy: 64 mm · Skrzydło: 105 mm
- Meneau mobile: 64 mm · Vantail: 105 mm
- Movable post: 64 mm · Sash: 105 mm
- Stulp: 64 mm · Flügel: 105 mm
- Montante mobile: 64 mm · Anta: 105 mm

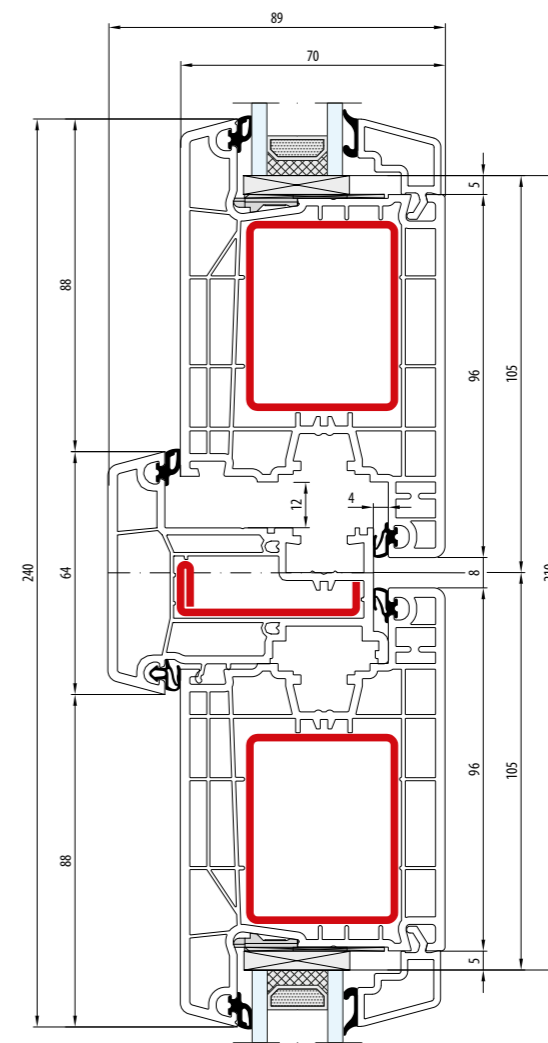
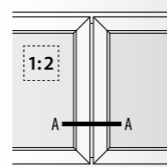

- Słupek ruchomy: 64 mm · Skrzydło: 116 mm
- Meneau mobile: 64 mm · Vantail: 116 mm
- Movable post: 64 mm · Sash: 116 mm
- Stulp: 64 mm · Flügel: 116 mm
- Montante mobile: 64 mm · Anta: 116 mm

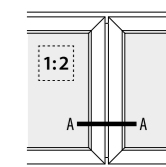

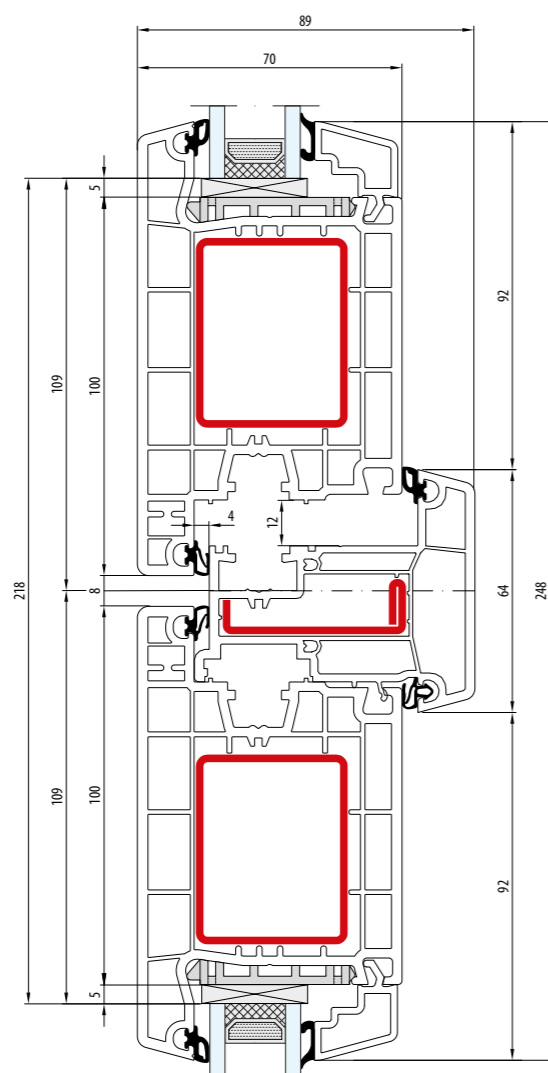

- Słupek ruchomy: 64 mm · Skrzydło: 120 mm
- Meneau mobile: 64 mm · Vantail: 120 mm
- Movable post: 64 mm · Sash: 120 mm
- Stulp: 64 mm · Flügel: 120 mm
- Montante mobile: 64 mm · Anta: 120 mm

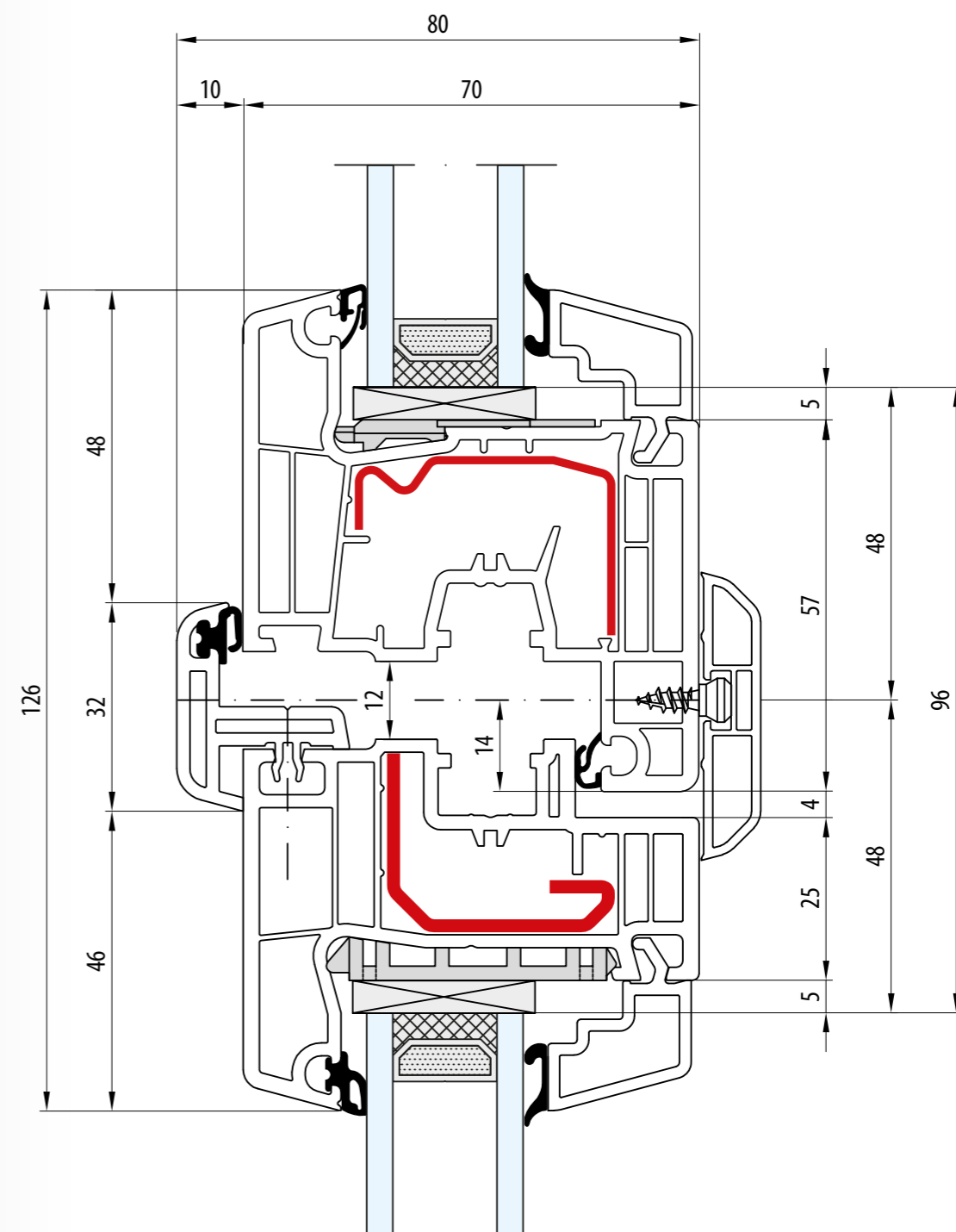
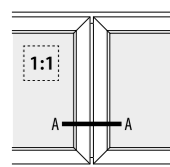
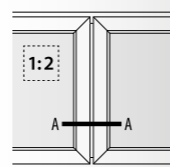

- Klamka centralna · Skrzydło: 77 mm
- Battue centrée · Vantail: 77 mm
- Central handle · Sash: 77 mm
- Zentrale Olive · Flügel: 77 mm
- Maniglia centrale · Anta: 77 mm



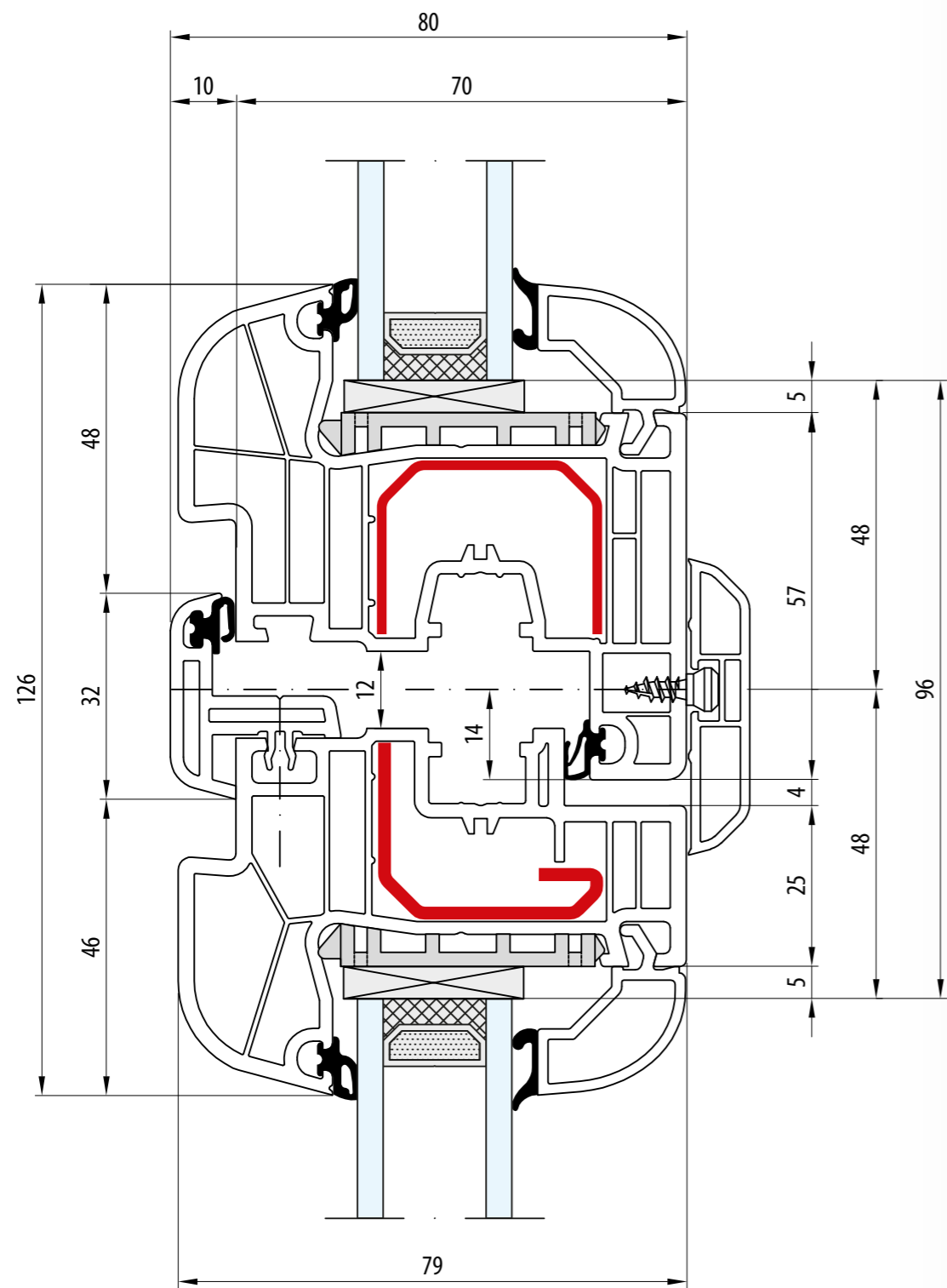

- Klamka centralna · Skrzydło: 77 mm
- Battue centrée · Vantail: 77 mm
- Central handle · Sash: 77 mm
- Zentrale Olive · Flügel: 77 mm
- Maniglia centrale · Anta: 77 mm

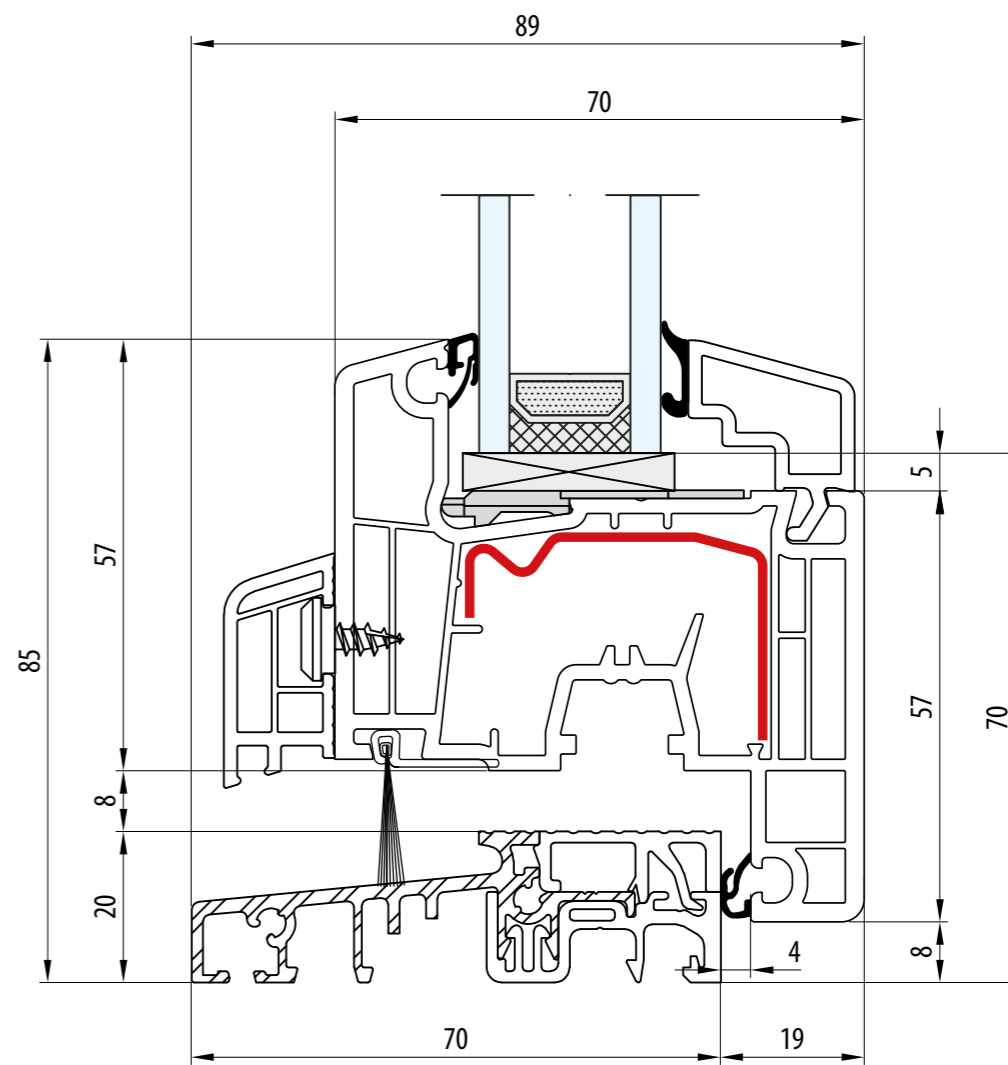
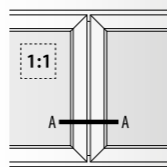

- Próg: 20 mm · Skrzydło: 77 mm
- Seuil: 20 mm · Vantail: 77 mm
- Threshold: 20 mm · Sash: 77 mm
- Schwelle: 20 mm · Flügel: 77 mm
- Soglia: 20 mm · Anta: 77 mm

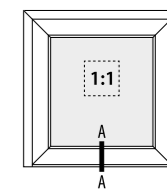

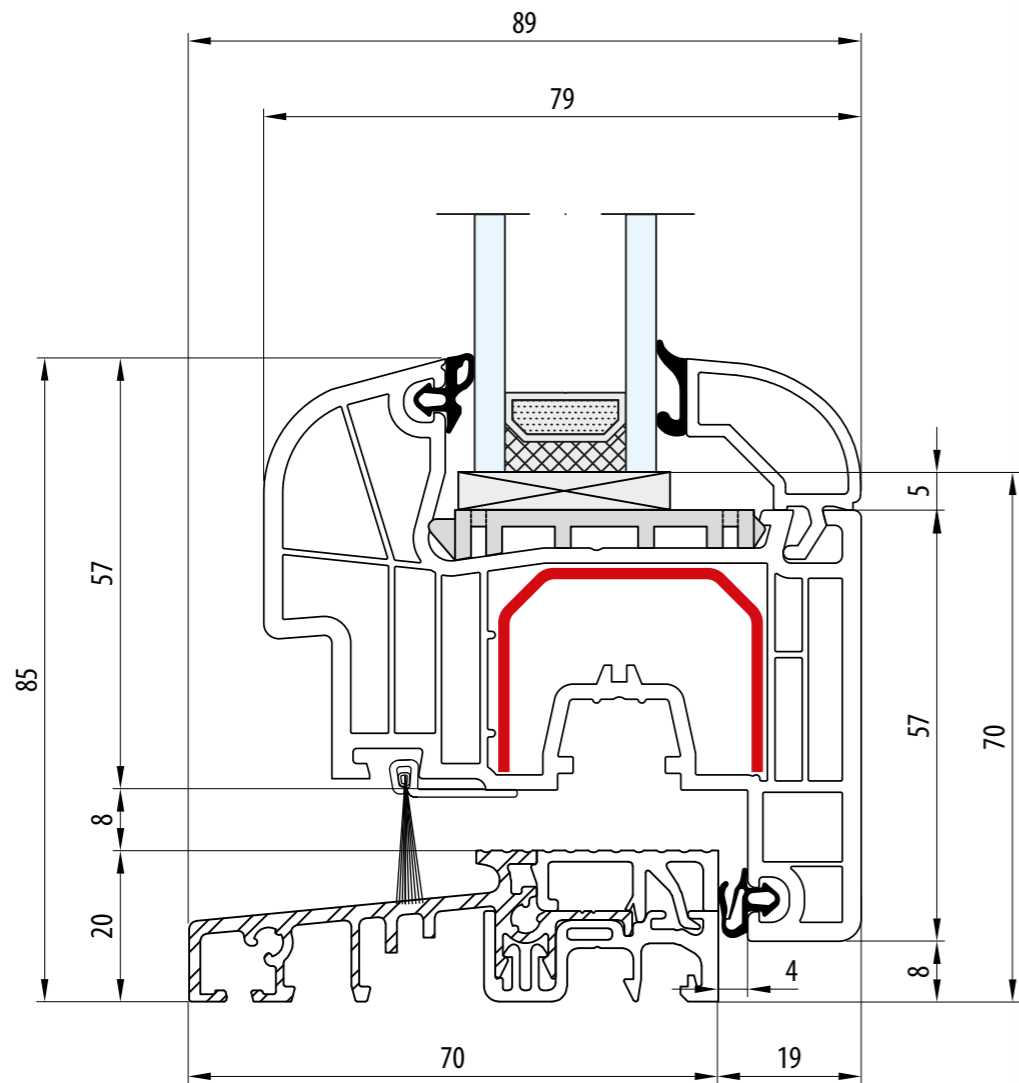

- Próg: 20 mm · Skrzydło: 77 mm
- Seuil: 20 mm · Vantail: 77 mm
- Threshold: 20 mm · Sash: 77 mm
- Schwelle: 20 mm · Flügel: 77 mm
- Soglia: 20 mm · Anta: 77 mm

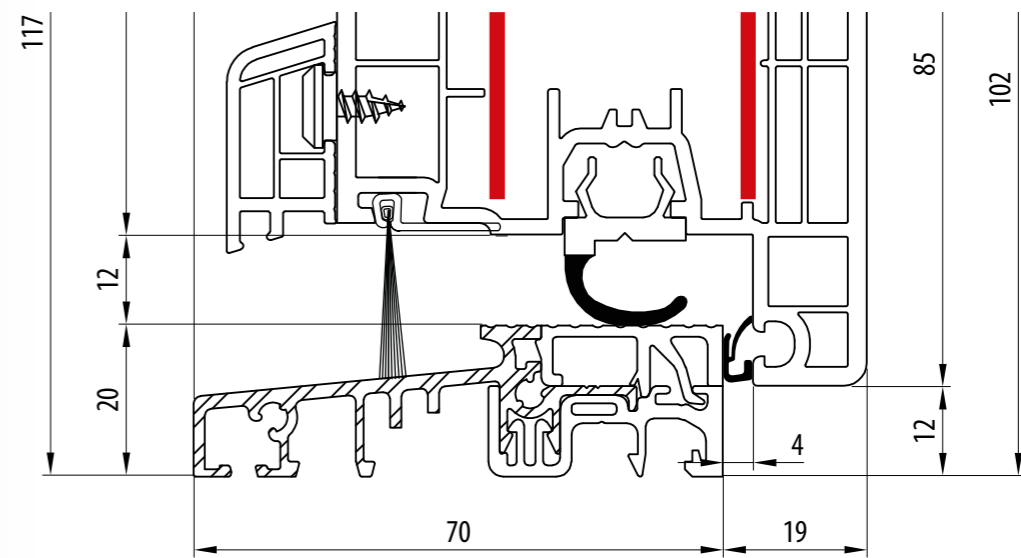
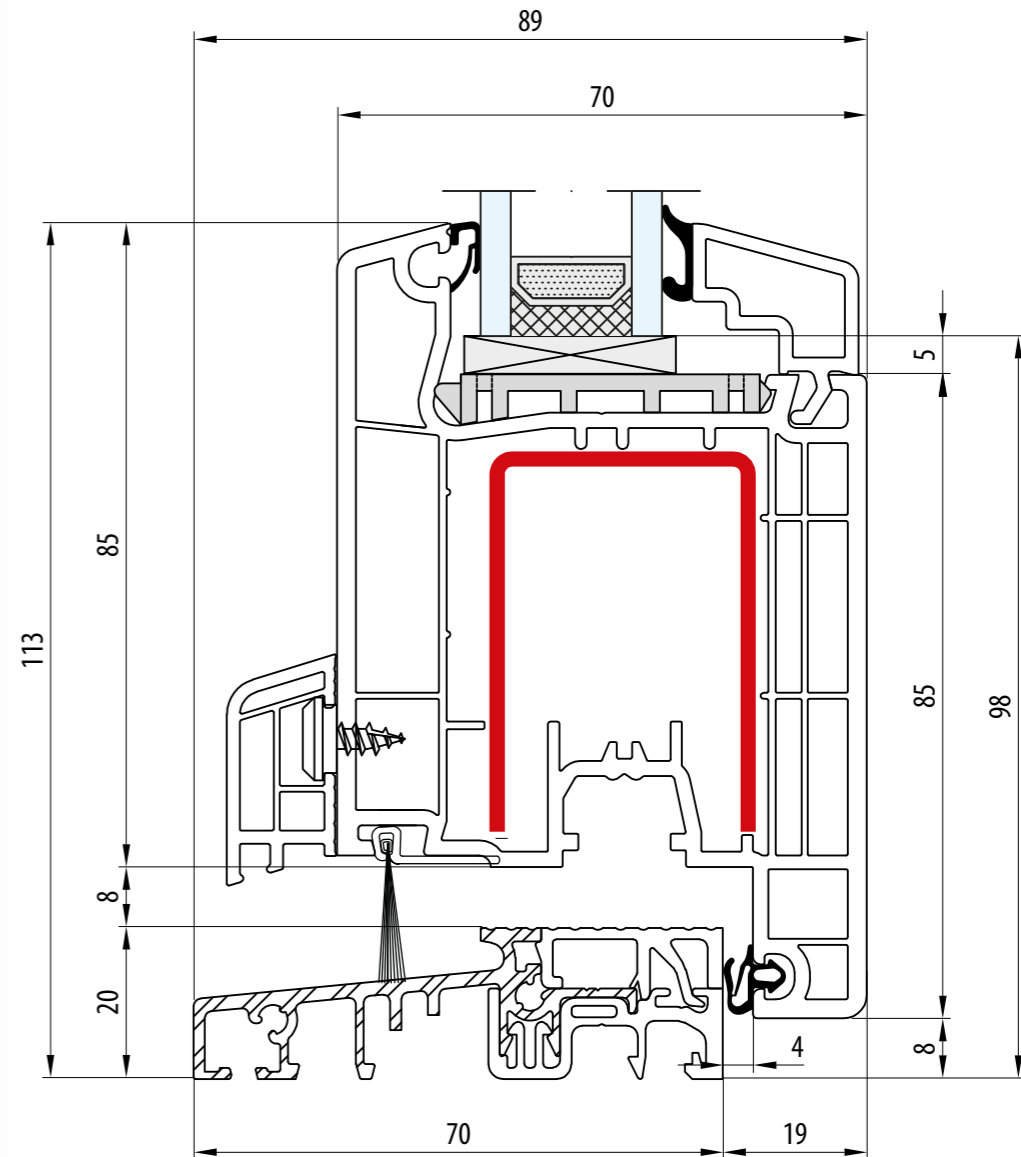
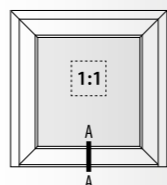

- Próg: 20 mm · Skrzydło: 105 mm
- Seuil: 20 mm · Vantail: 105 mm
- Threshold: 20 mm · Sash: 105 mm
- Schwelle: 20 mm · Flügel: 105 mm
- Soglia: 20 mm · Anta: 105 mm

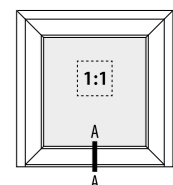

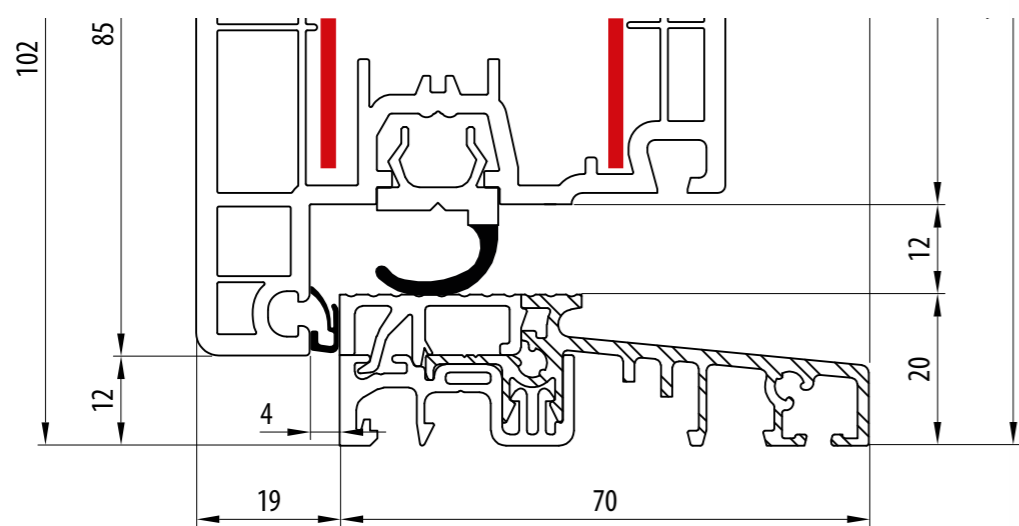
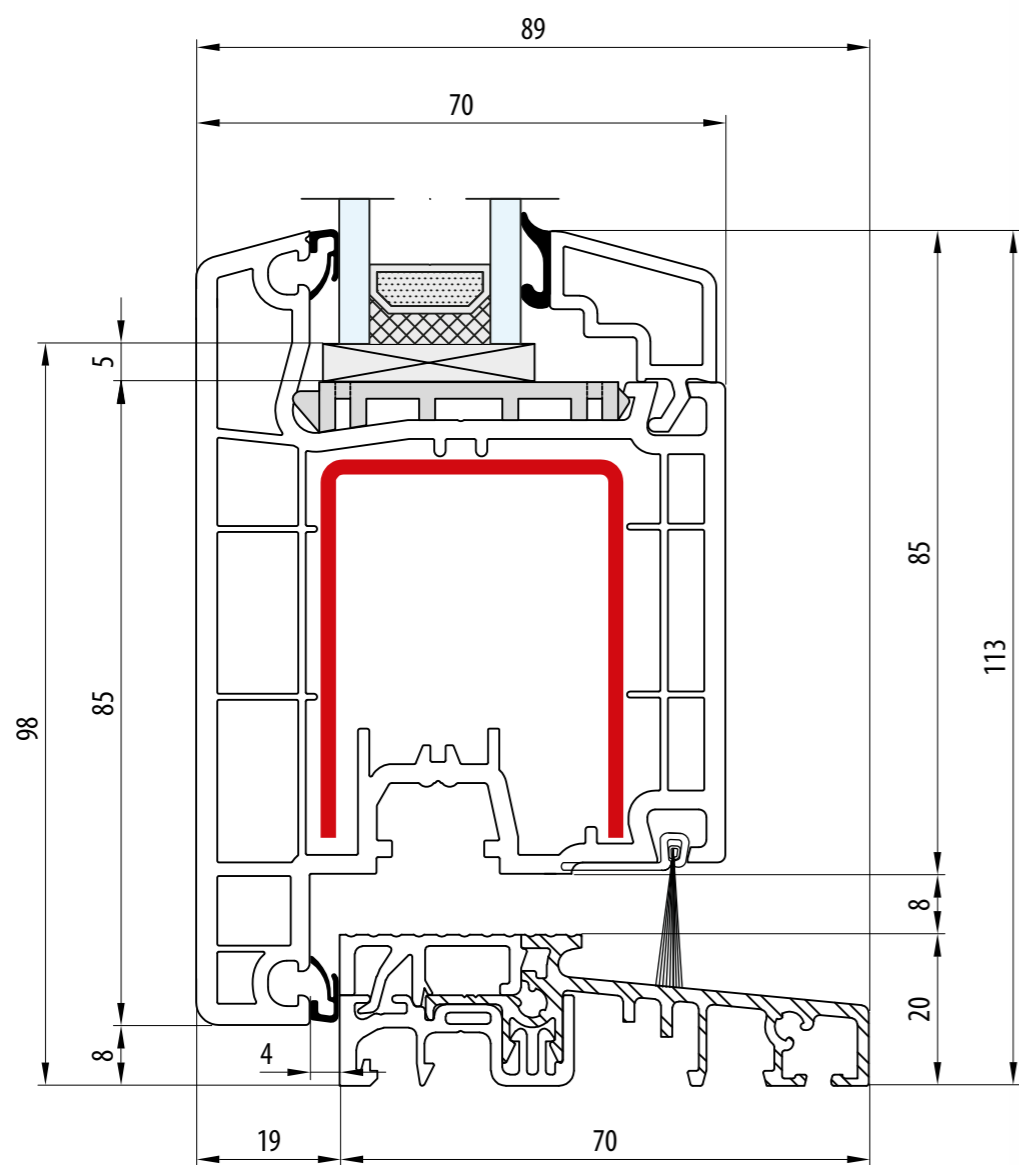

- Próg: 20 mm · Skrzydło: 105 mm
- Seuil: 20 mm · Vantail: 105 mm
- Threshold: 20 mm · Sash: 105 mm
- Schwelle: 20 mm · Flügel: 105 mm
- Soglia: 20 mm · Anta: 105 mm

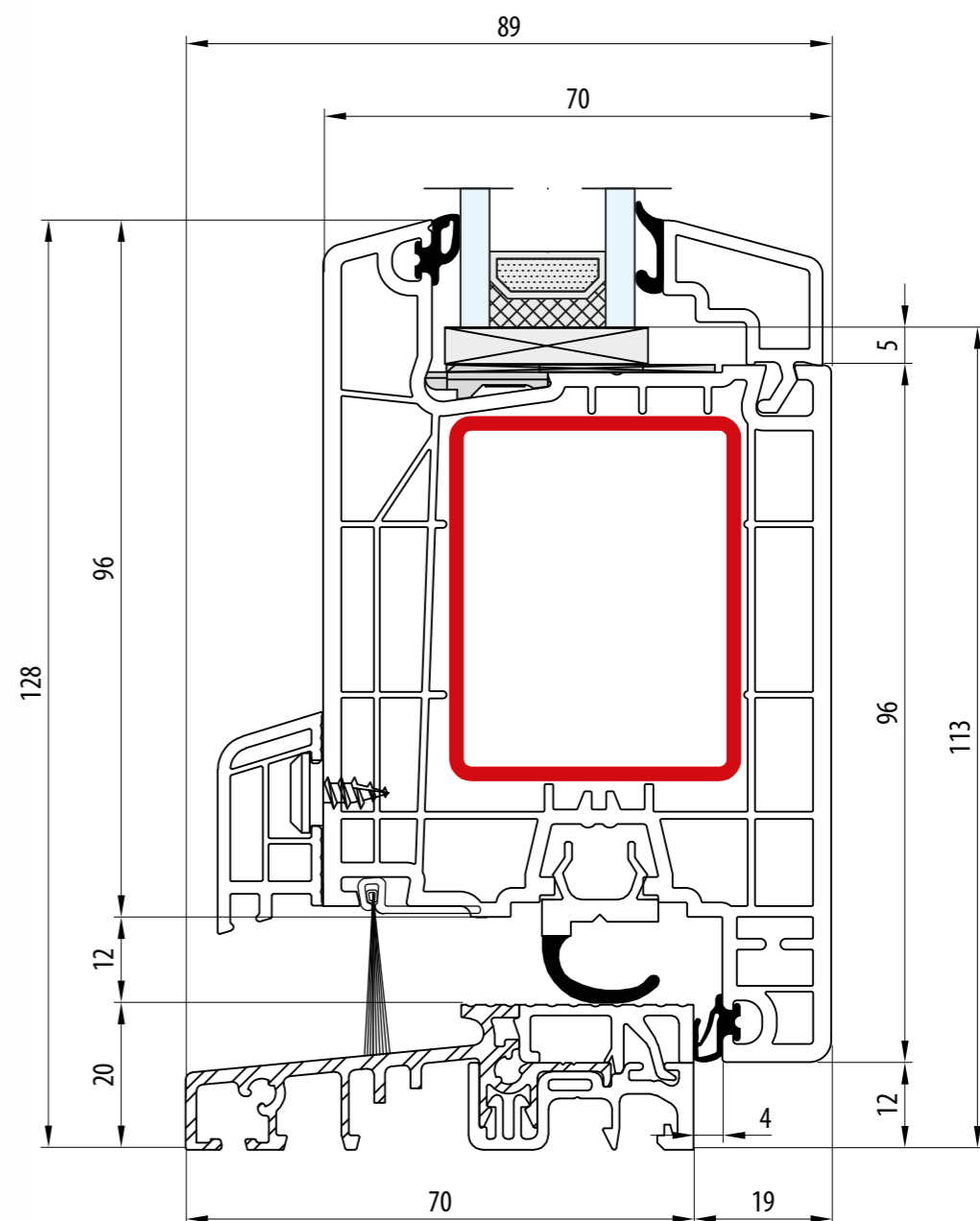
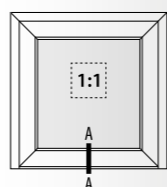

- Próg: 20 mm · Skrzydło: 116 mm
- Seuil: 20 mm · Vantail: 116 mm
- Threshold: 20 mm · Sash: 116 mm
- Schwelle: 20 mm · Flügel: 116 mm
- Soglia: 20 mm · Anta: 116 mm

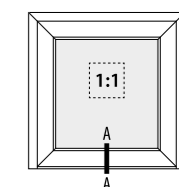

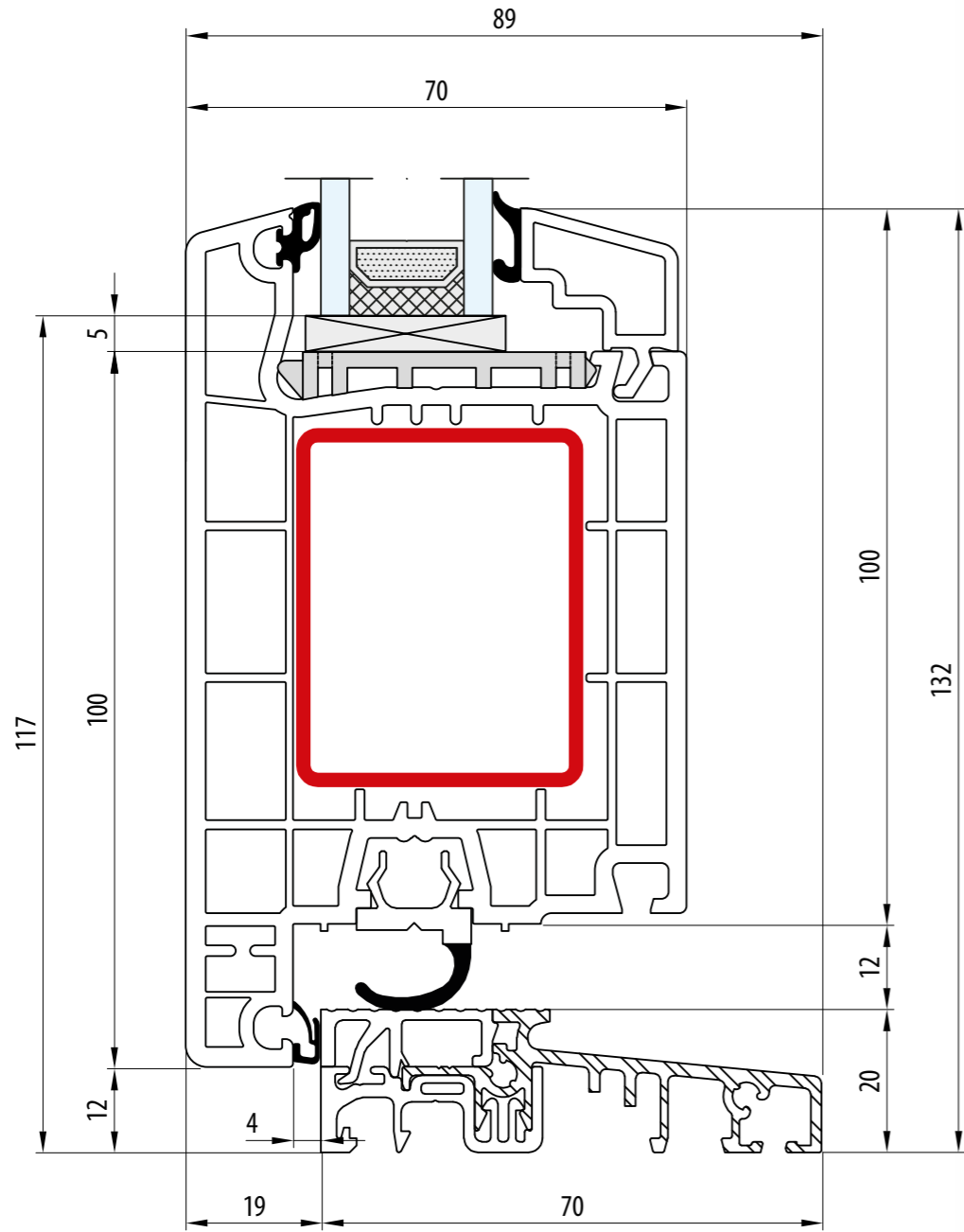

- Próg: 20 mm · Skrzydło: 120 mm
- Seuil: 20 mm · Vantail: 120 mm
- Threshold: 20 mm · Sash: 120 mm
- Schwelle: 20 mm · Flügel: 120 mm
- Soglia: 20 mm · Anta: 120 mm

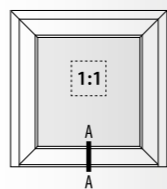

IDEAL 4000 NEW

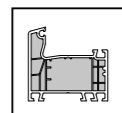
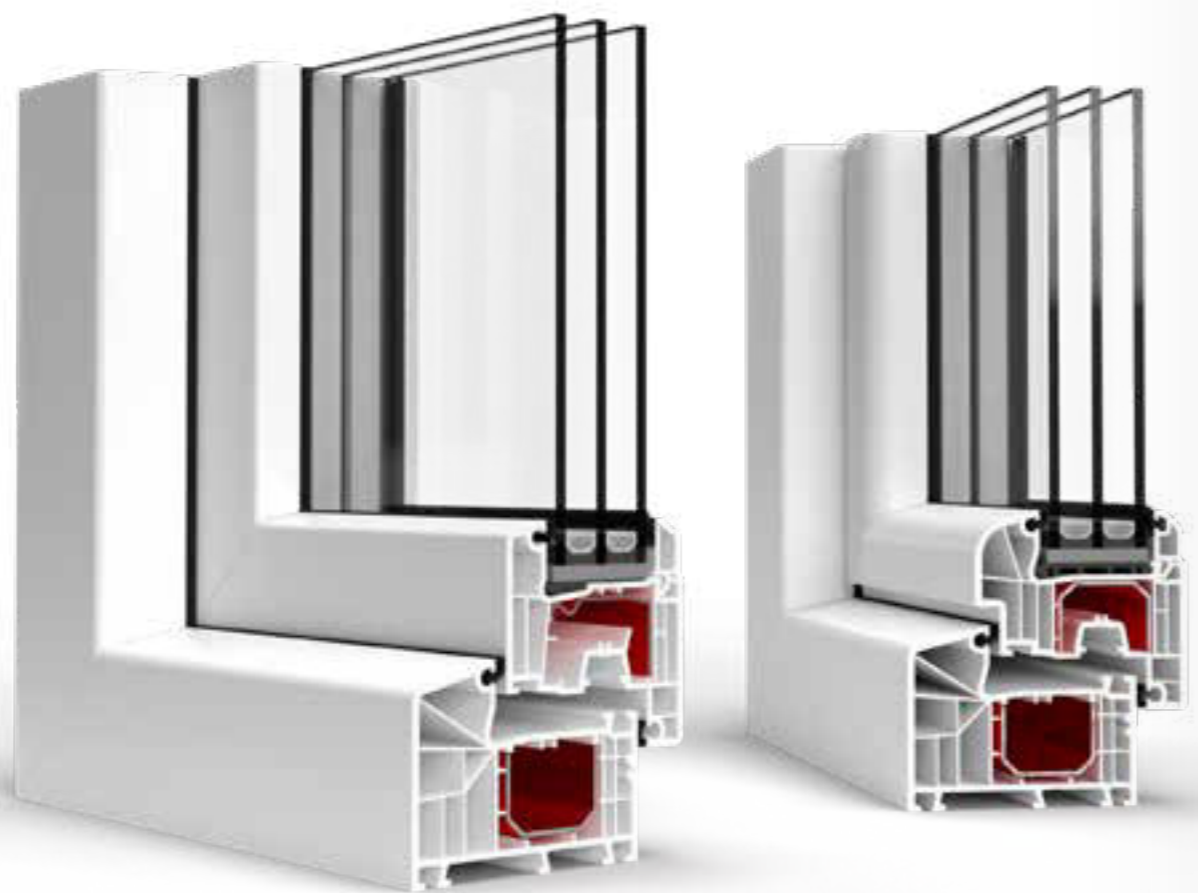

6



2

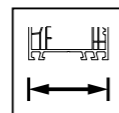

85

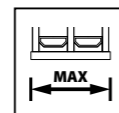

42

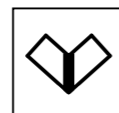

V-SUPER SOLUTION

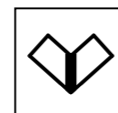

V-PERFECT TECHNOLOGY



IDEAL 4000

IDEAL 4000 NEW

IDEAL 5000

IDEAL 7000 NEW

IDEAL 8000

ENERGETO 8000

IDEAL 4000

IDEAL 4000 NEW

IDEAL 5000

IDEAL 7000 NEW

IDEAL 8000

ENERGETO 8000

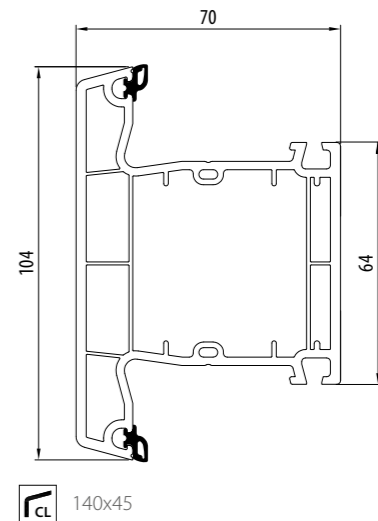
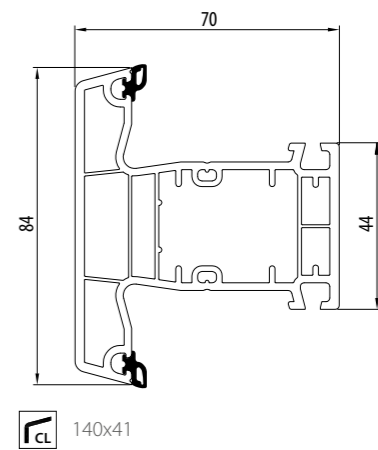
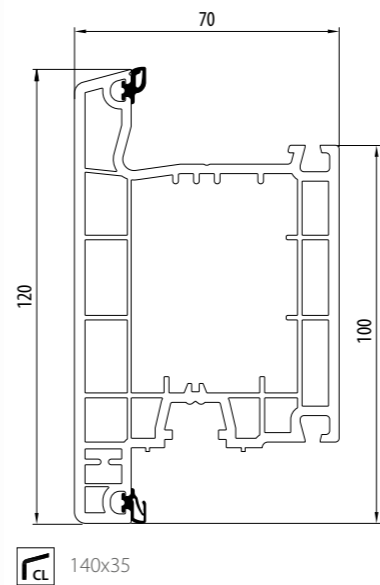
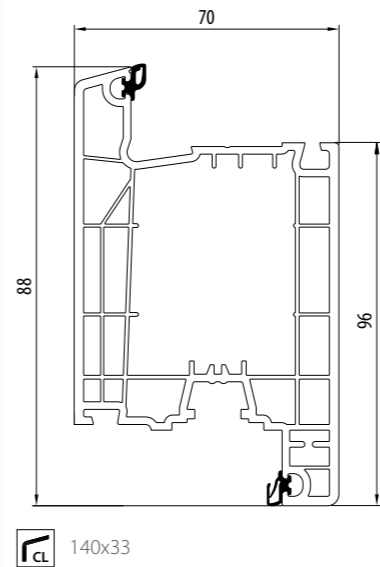
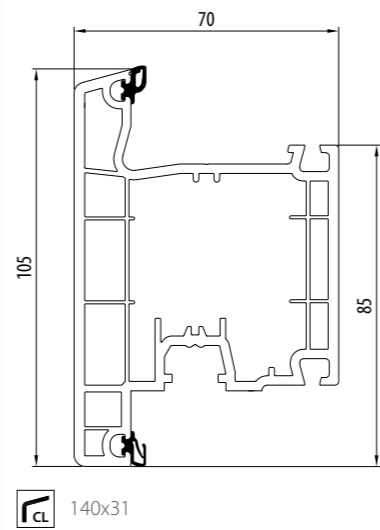
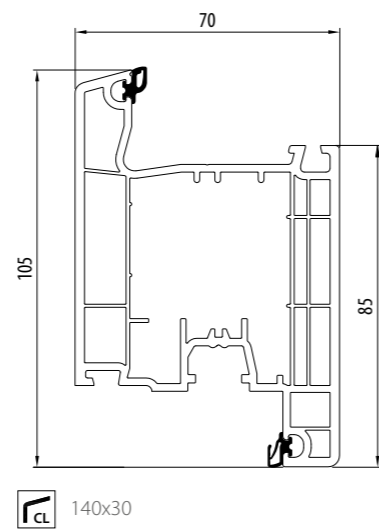
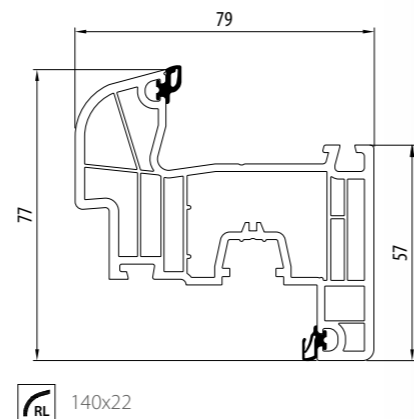
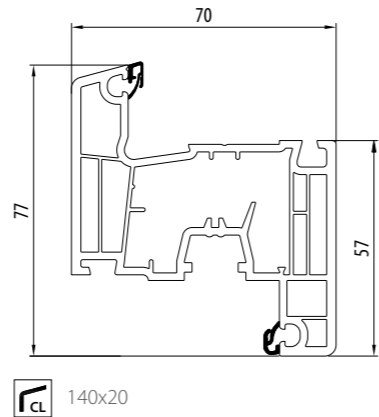
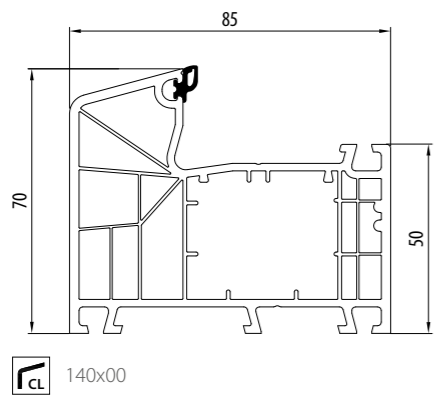

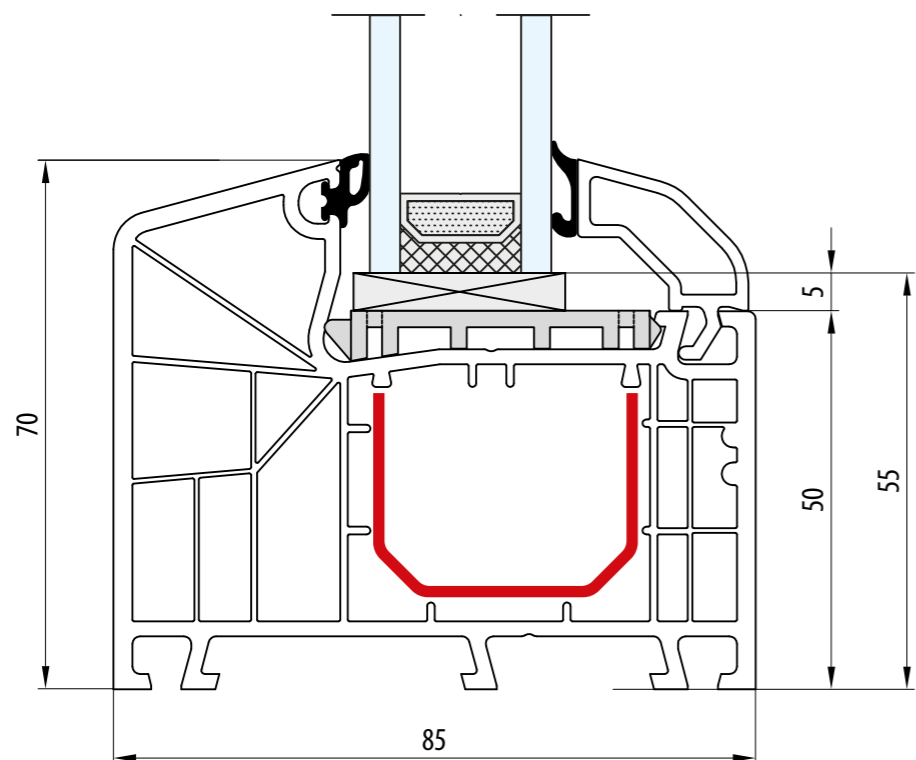

- Rama: 70 mm
- Dormant: 70 mm
- Frame: 70 mm
- Rahmen: 70 mm
- Telaio: 70 mm

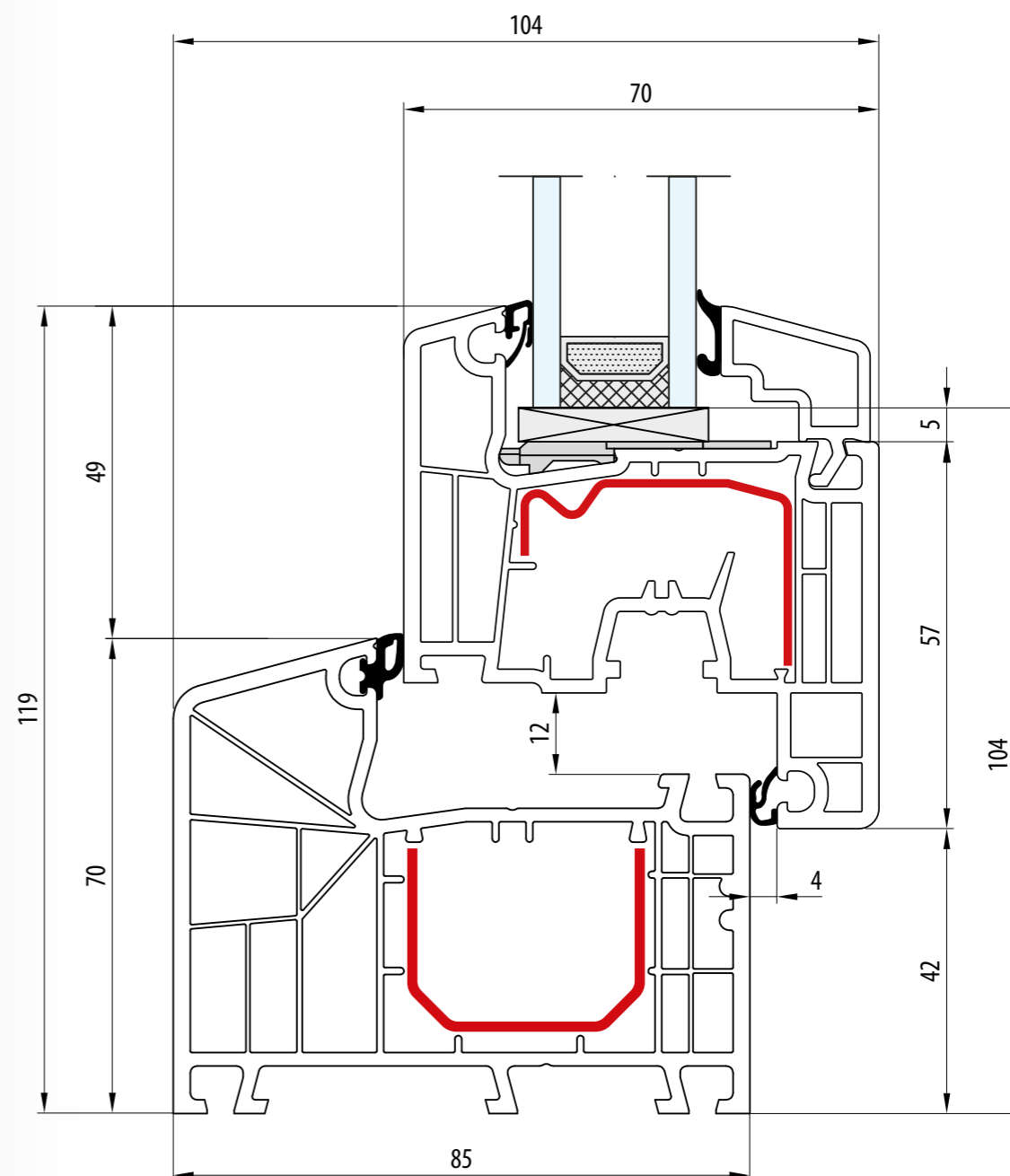
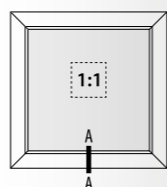

- Rama: 70 mm · Skrzydło: 77 mm
- Dormant: 70 mm · Vantail: 77 mm
- Frame: 70 mm · Sash: 77 mm
- Rahmen: 70 mm · Flügel: 77 mm
- Telaio: 70 mm · Anta: 77 mm

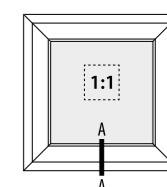

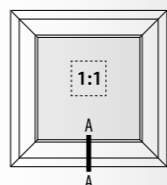
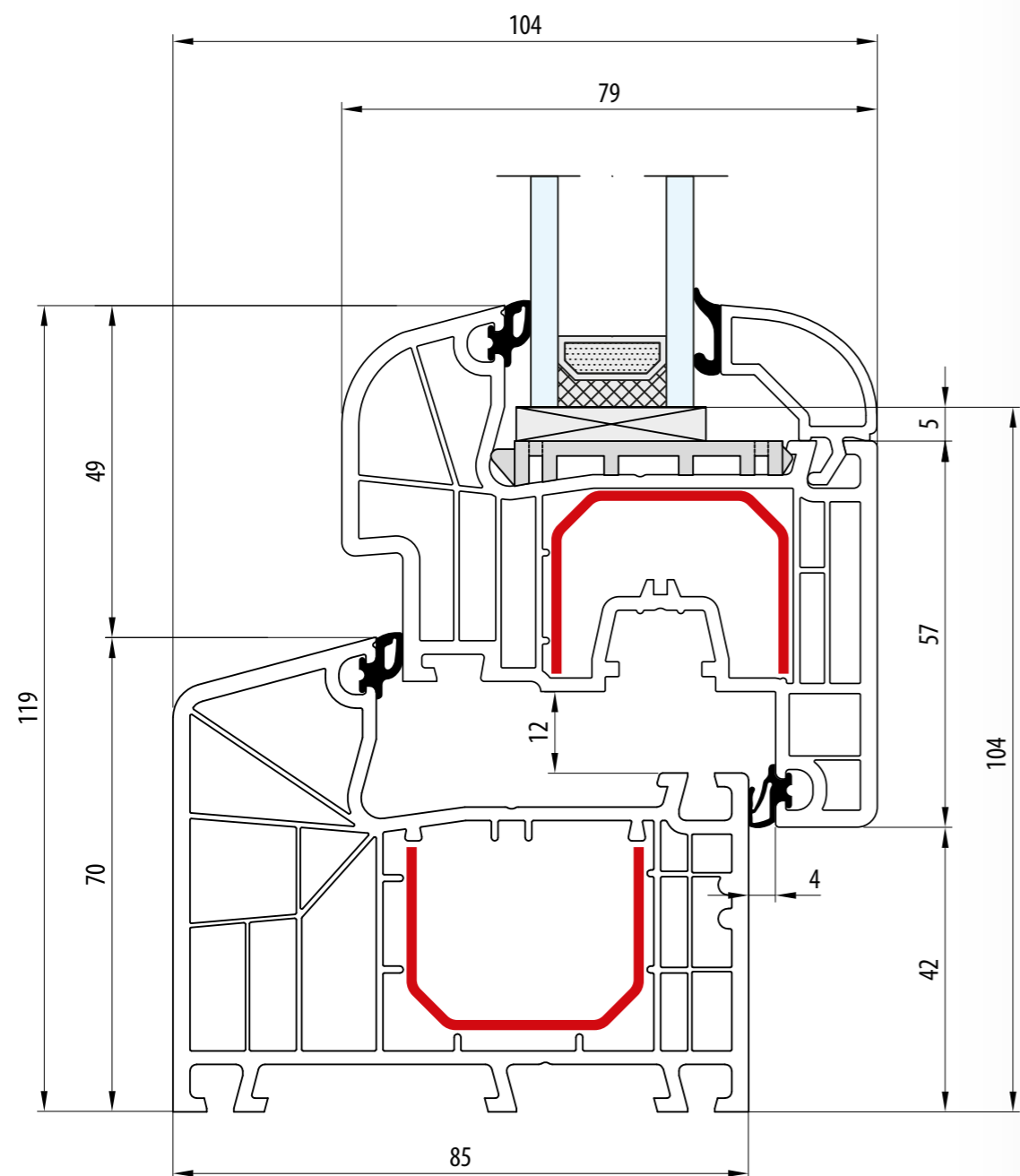

- Rama: 70 mm · Skrzydło: 77 mm
- Dormant: 70 mm · Vantail: 77 mm
- Frame: 70 mm · Sash: 77 mm
- Rahmen: 70 mm · Flügel: 77 mm
- Telaio: 70 mm · Anta: 77 mm

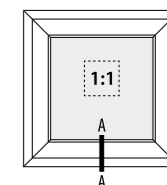
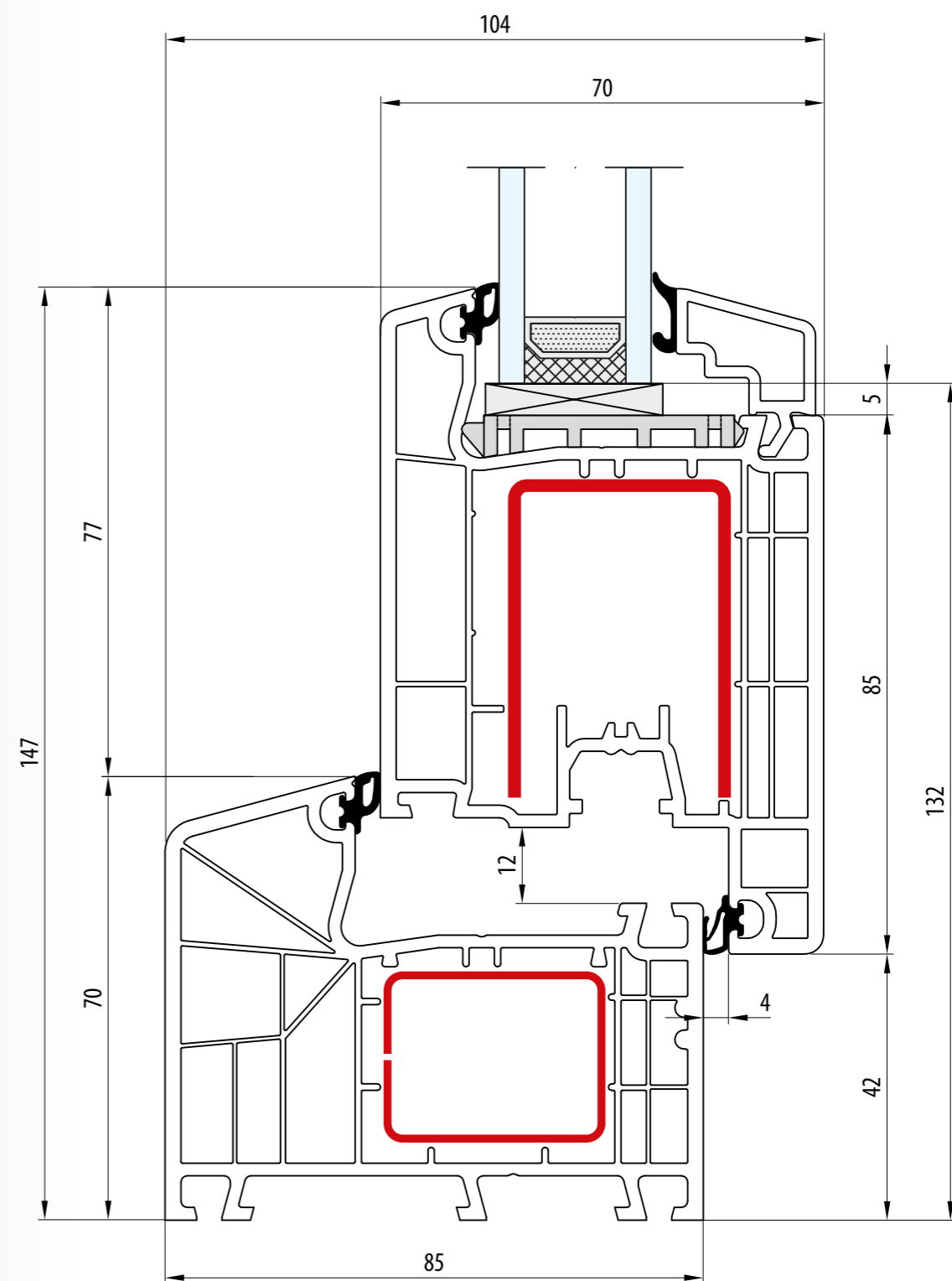

- Rama: 70 mm · Skrzydło: 105 mm
- Dormant: 70 mm · Vantail: 105 mm
- Frame: 70 mm · Sash: 105 mm
- Rahmen: 70 mm · Flügel: 105 mm
- Telaio: 70 mm · Anta: 105 mm

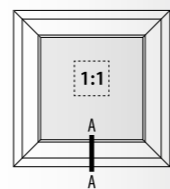
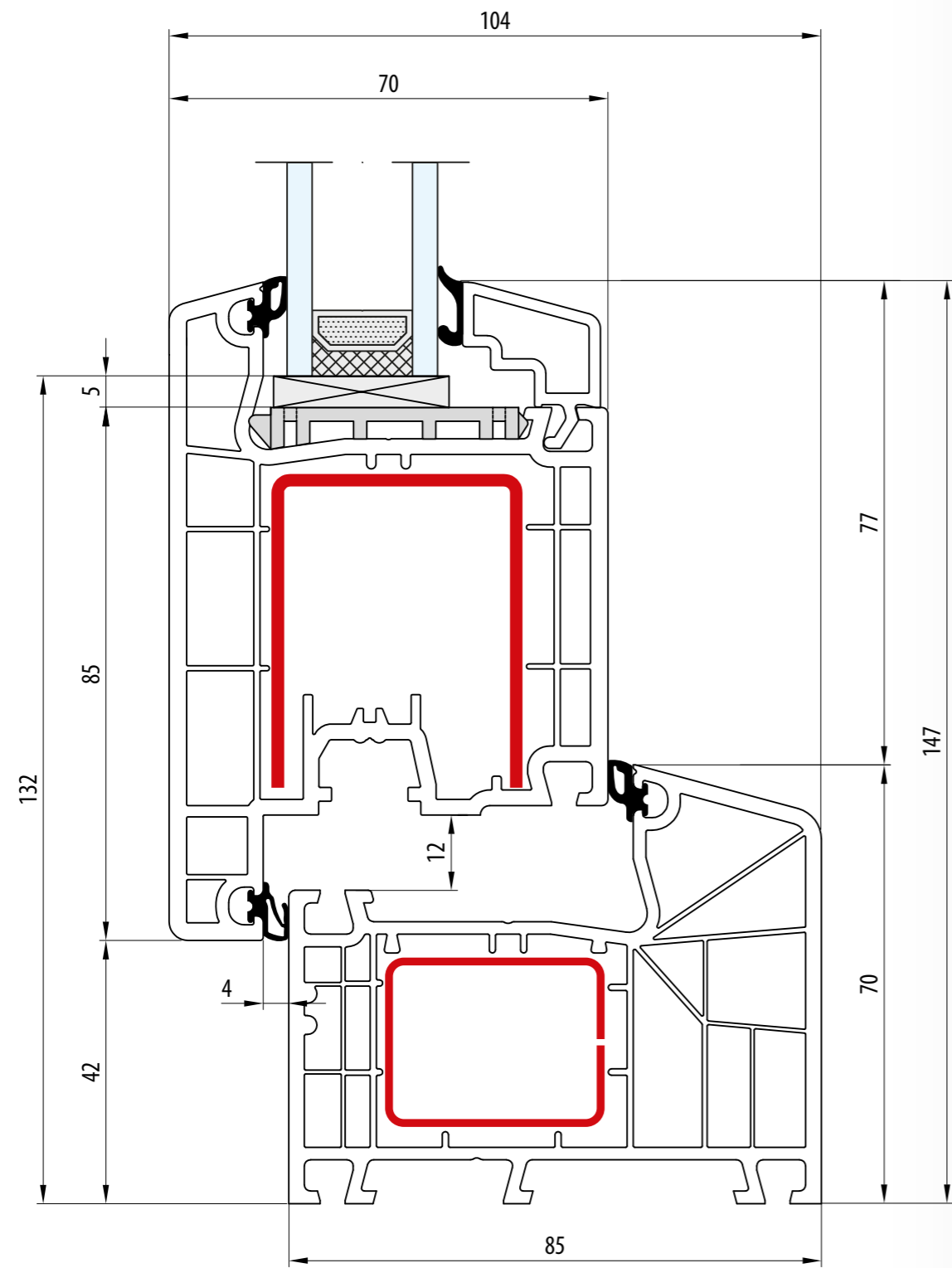

- Rama: 70 mm · Skrzydło: 105 mm
- Dormant: 70 mm · Vantail: 105 mm
- Frame: 70 mm · Sash: 105 mm
- Rahmen: 70 mm · Flügel: 105 mm
- Telaio: 70 mm · Anta: 105 mm

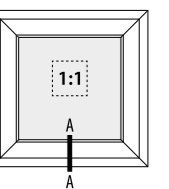
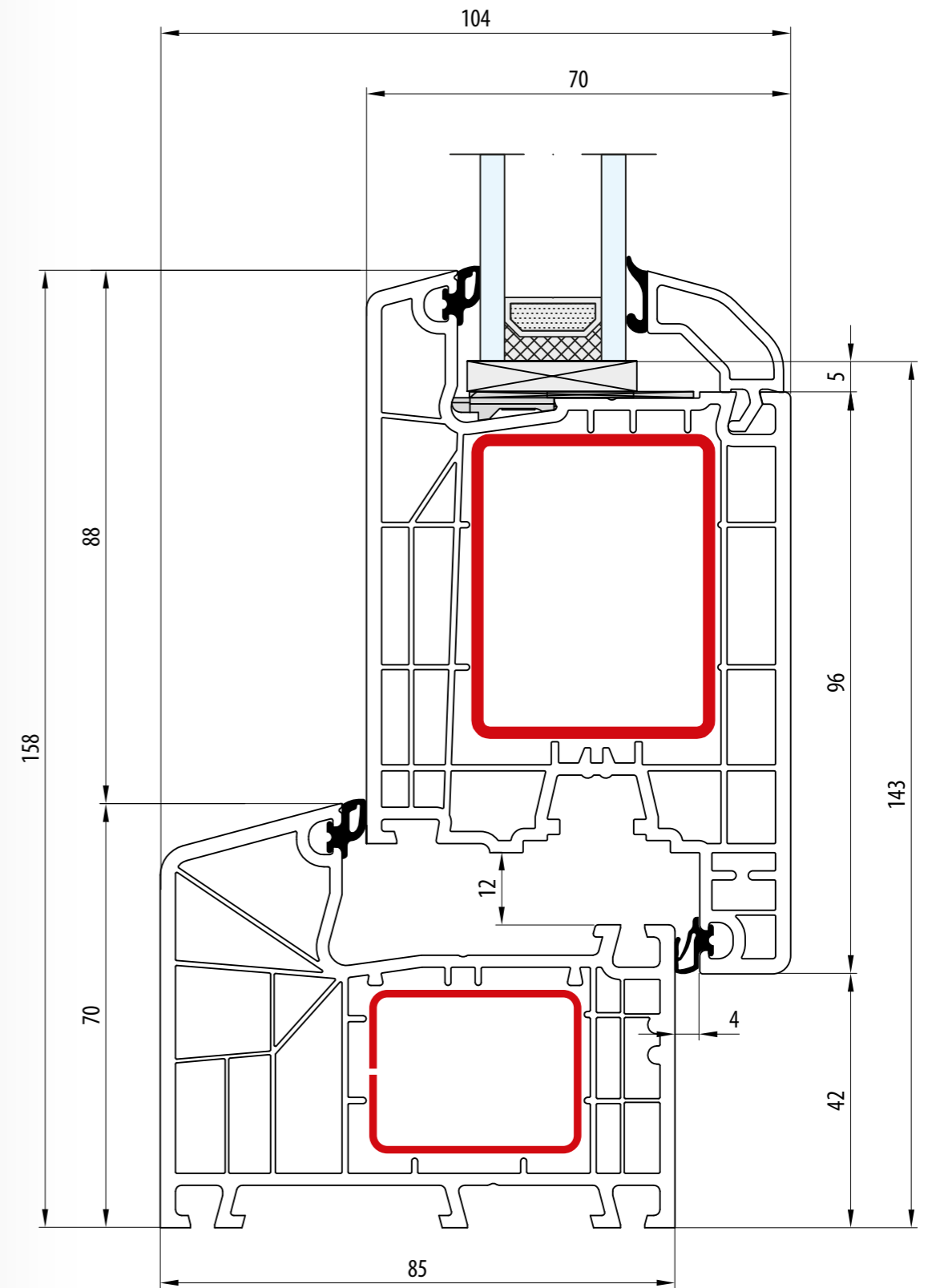

- Rama: 70 mm · Skrzydło: 116 mm
- Dormant: 70 mm · Vantail: 116 mm
- Frame: 70 mm · Sash: 116 mm
- Rahmen: 70 mm · Flügel: 116 mm
- Telaio: 70 mm · Anta: 116 mm

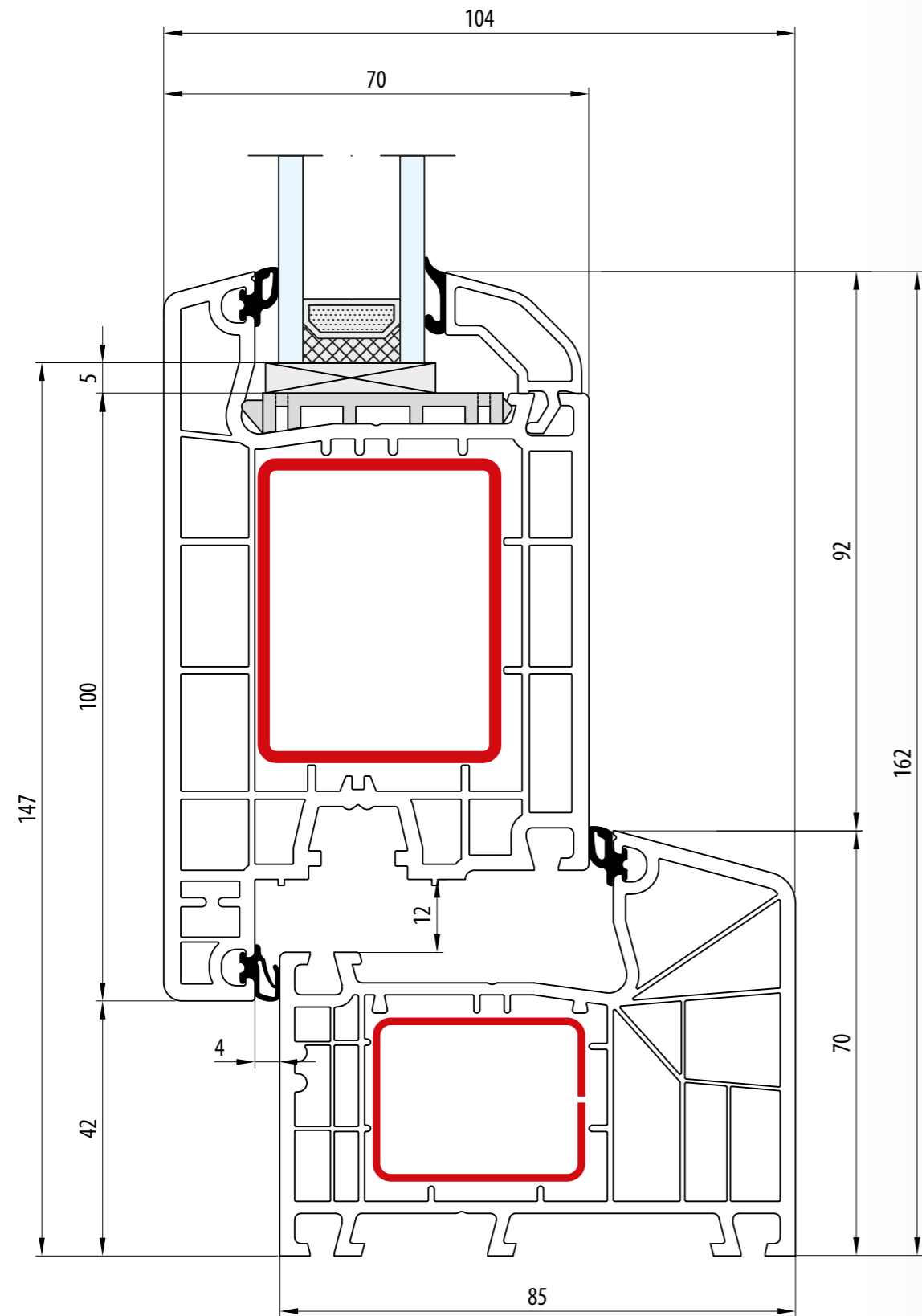

- Rama: 70 mm · Skrzydło: 120 mm
- Dormant: 70 mm · Vantail: 120 mm
- Frame: 70 mm · Sash: 120 mm
- Rahmen: 70 mm · Flügel: 120 mm
- Telaio: 70 mm · Anta: 120 mm

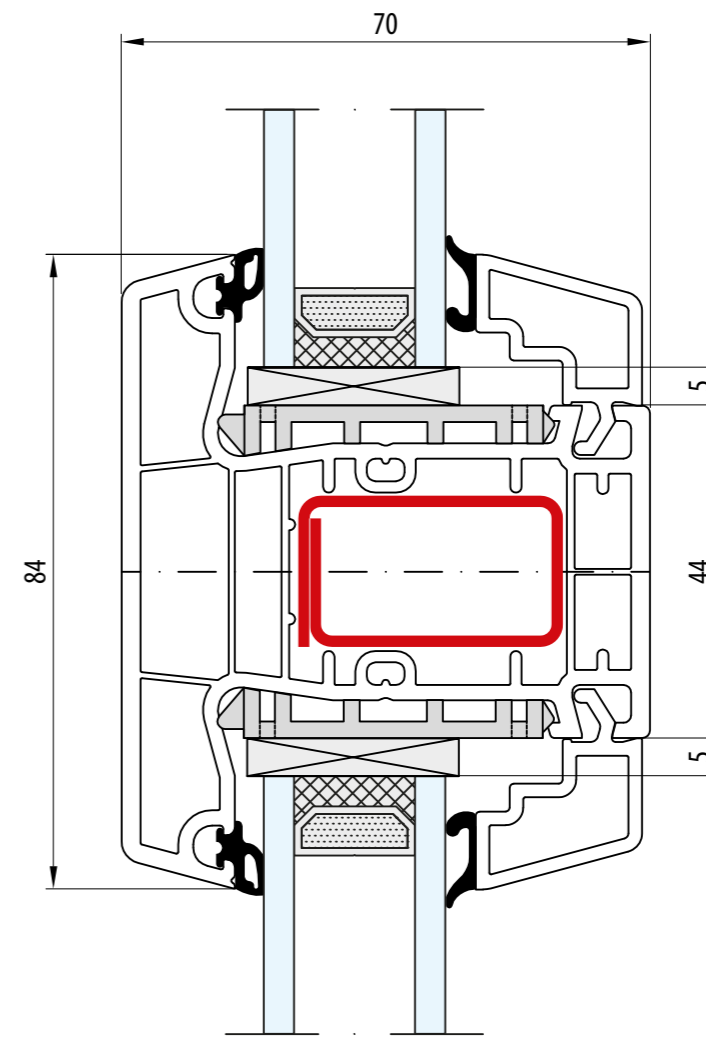
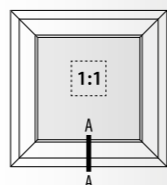

- Słupek staly: 84 mm
- Meneau fixe: 84 mm
- Fix post: 84 mm
- Festem Pfahl: 84 mm
- Montante fisso: 84 mm

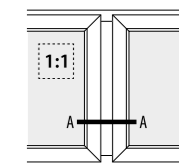

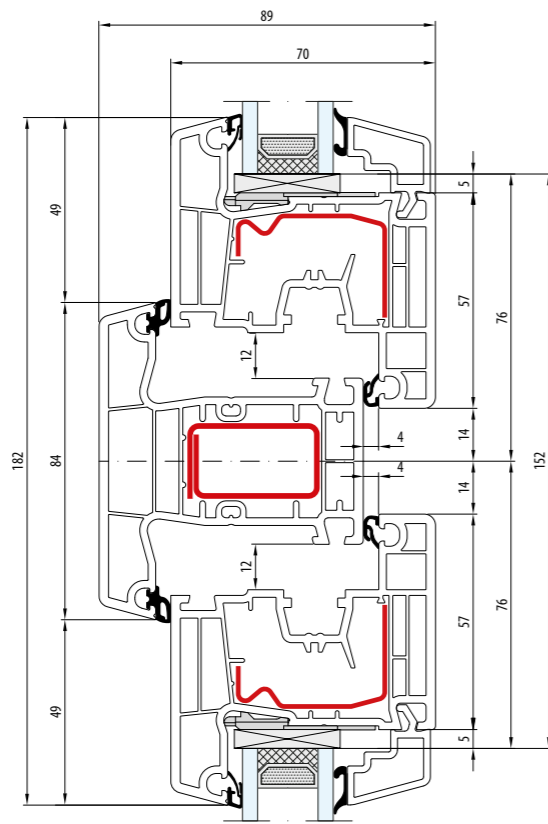

- Słupek stalowy: 84 mm · Skrzydło: 77 mm
- Meneau fixe: 84 mm · Vantail: 77 mm
- Fix post: 84 mm · Sash: 77 mm
- Festem Pfahl: 84 mm · Flügel: 77 mm
- Montante fisso: 84 mm · Anta: 77 mm

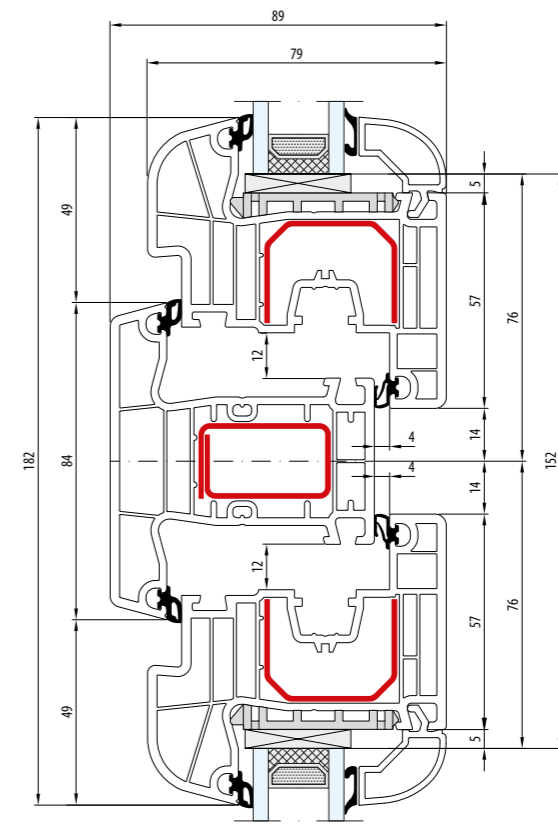
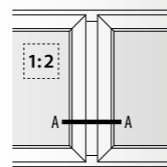

- Słupek stalowy: 84 mm · Skrzydło: 77 mm
- Meneau fixe: 84 mm · Vantail: 77 mm
- Fix post: 84 mm · Sash: 77 mm
- Festem Pfahl: 84 mm · Flügel: 77 mm
- Montante fisso: 84 mm · Anta: 77 mm

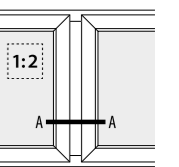

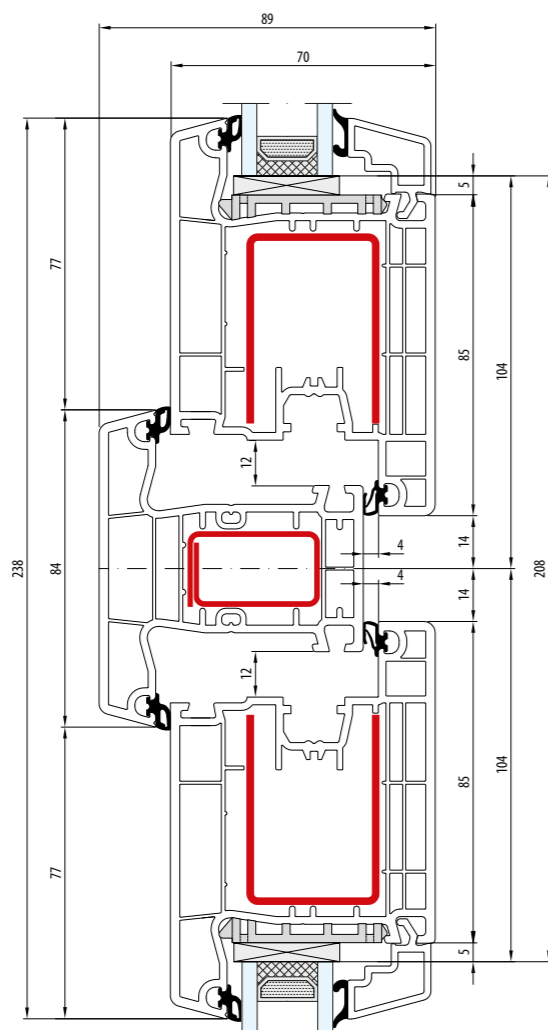

- Słupek stalowy: 84 mm · Skrzydło: 105 mm
- Meneau fixe: 84 mm · Vantail: 105 mm
- Fix post: 84 mm · Sash: 105 mm
- Festem Pfahl: 84 mm · Flügel: 105 mm
- Montante fisso: 84 mm · Anta: 105 mm

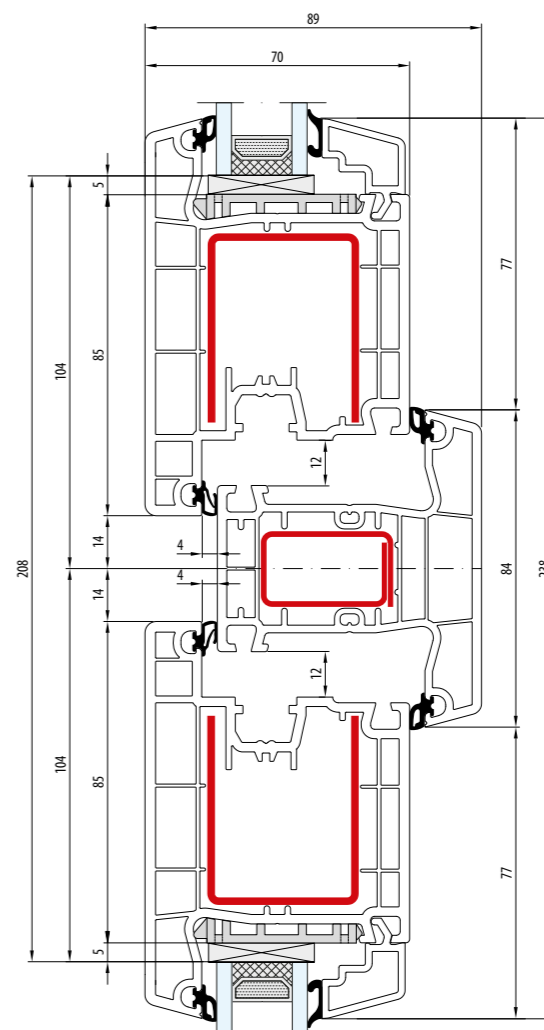
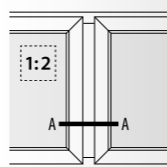

- Słupek stalowy: 84 mm · Skrzydło: 105 mm
- Meneau fixe: 84 mm · Vantail: 105 mm
- Fix post: 84 mm · Sash: 105 mm
- Festem Pfahl: 84 mm · Flügel: 105 mm
- Montante fisso: 84 mm · Anta: 105 mm

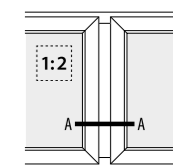

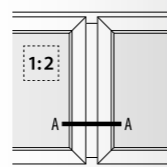
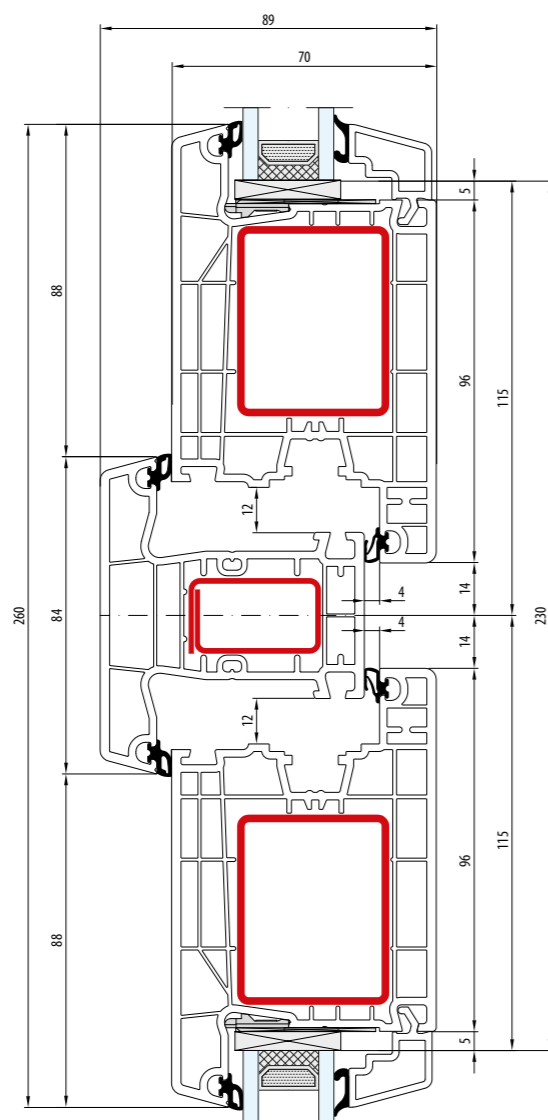

- Słupek stały: 84 mm · Skrzydło: 116 mm
- Meneau fixe: 84 mm · Vantail: 116 mm
- Fix post: 84 mm · Sash: 116 mm
- Festem Pfahl: 84 mm · Flügel: 116 mm
- Montante fisso: 84 mm · Anta: 116 mm

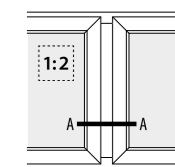
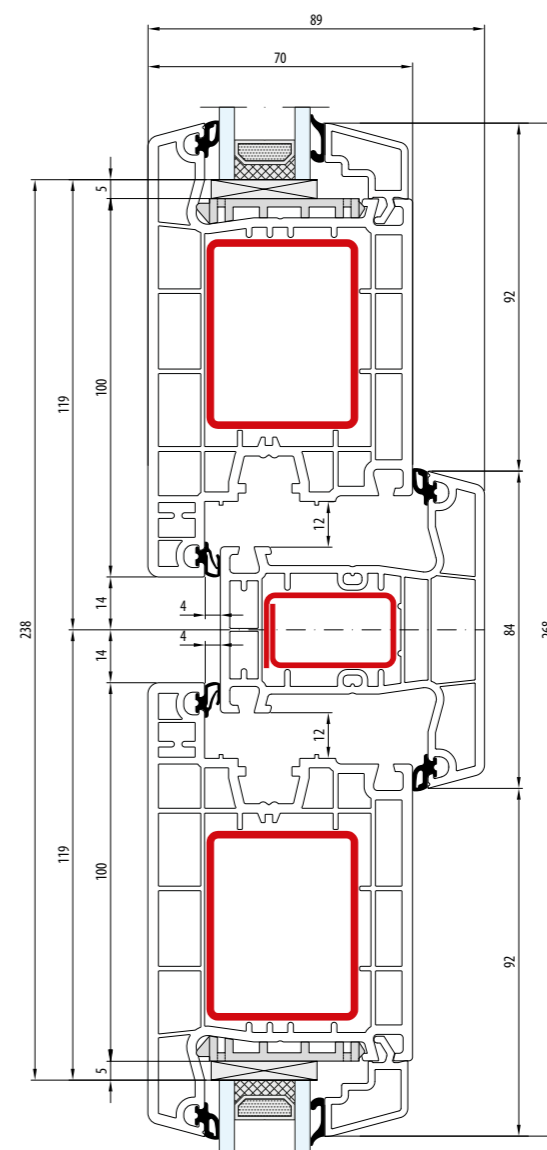

- Słupek stały: 84 mm · Skrzydło: 120 mm
- Meneau fixe: 84 mm · Vantail: 120 mm
- Fix post: 84 mm · Sash: 120 mm
- Festem Pfahl: 84 mm · Flügel: 120 mm
- Montante fisso: 84 mm · Anta: 120 mm

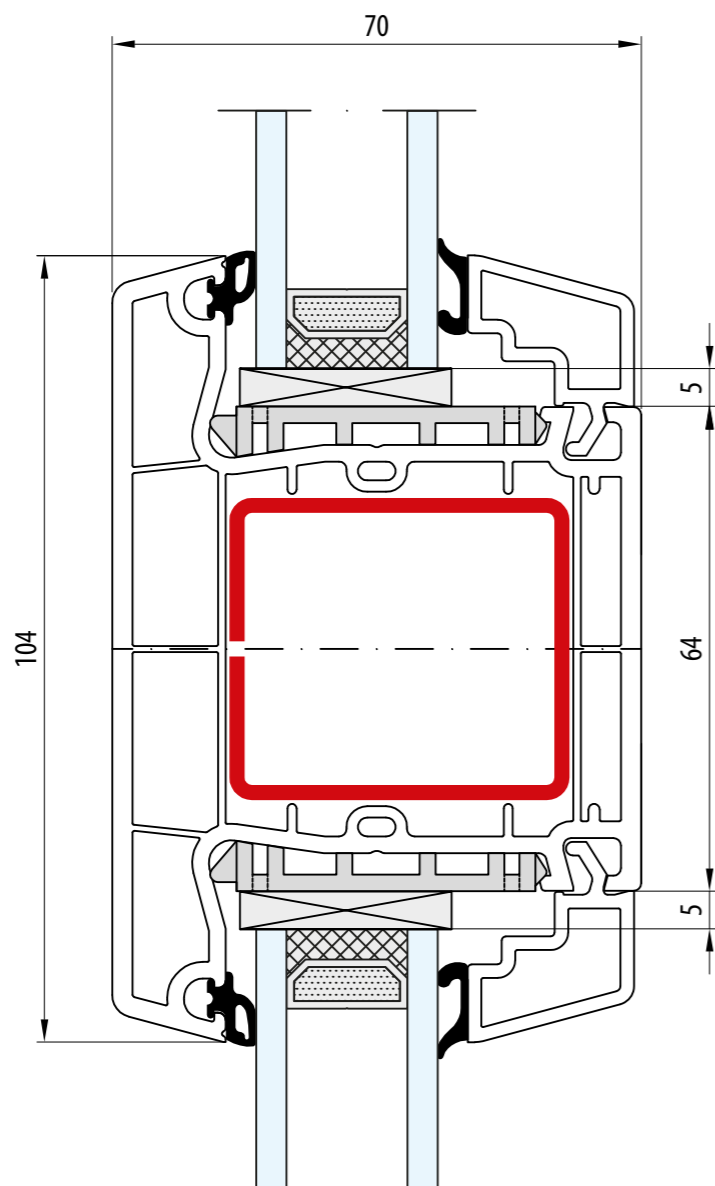

- Słupek stalowy: 104 mm
- Meneau fixe: 104 mm
- Fix post: 104 mm
- Festem Pfahl: 104 mm
- Montante fisso: 104 mm

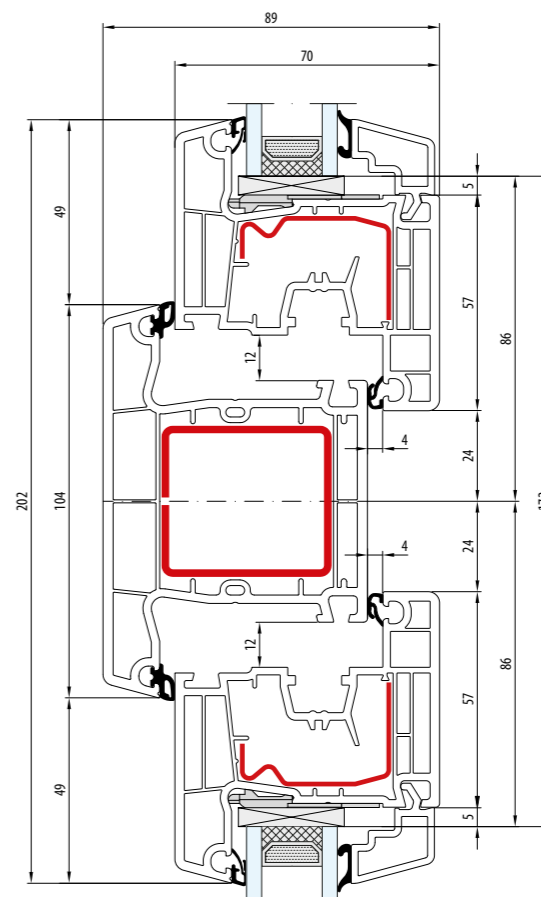
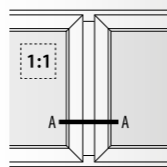

- Słupek stalowy: 104 mm · Skrzydło: 77 mm
- Meneau fixe: 104 mm · Vantail: 77 mm
- Fix post: 104 mm · Sash: 77 mm
- Festem Pfahl: 104 mm · Flügel: 77 mm
- Montante fisso: 104 mm · Anta: 77 mm

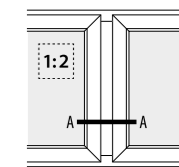

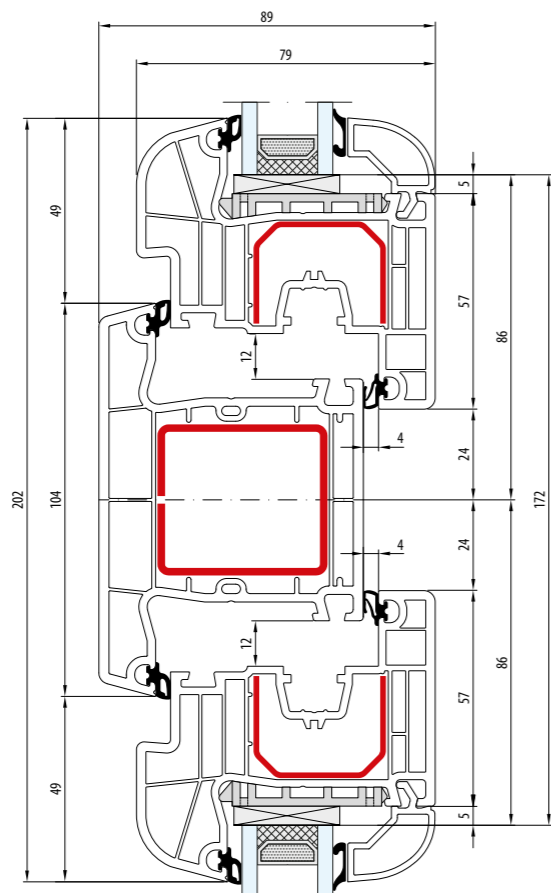

- Słupek stały: 104 mm · Skrzydło: 77 mm
- Meneau fixe: 104 mm · Vantail: 77 mm
- Fix post: 104 mm · Sash: 77 mm
- Festem Pfahl: 104 mm · Flügel: 77 mm
- Montante fisso: 104 mm · Anta: 77 mm

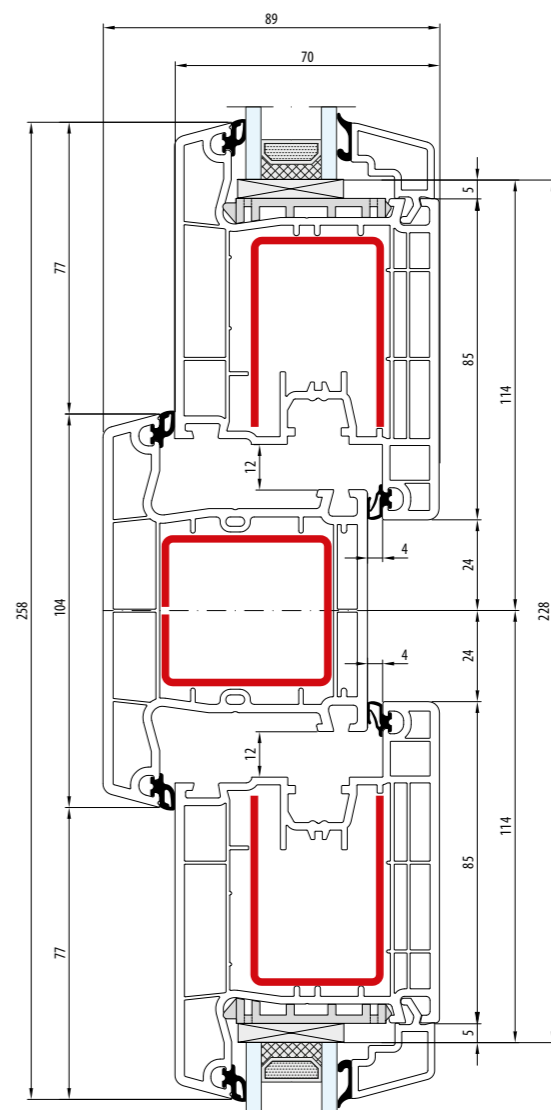
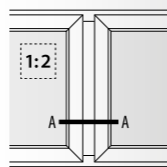

- Słupek stały: 104 mm · Skrzydło: 105 mm
- Meneau fixe: 104 mm · Vantail: 105 mm
- Fix post: 104 mm · Sash: 105 mm
- Festem Pfahl: 104 mm · Flügel: 105 mm
- Montante fisso: 104 mm · Anta: 105 mm

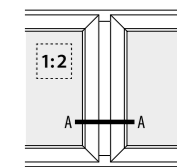

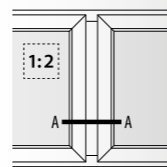
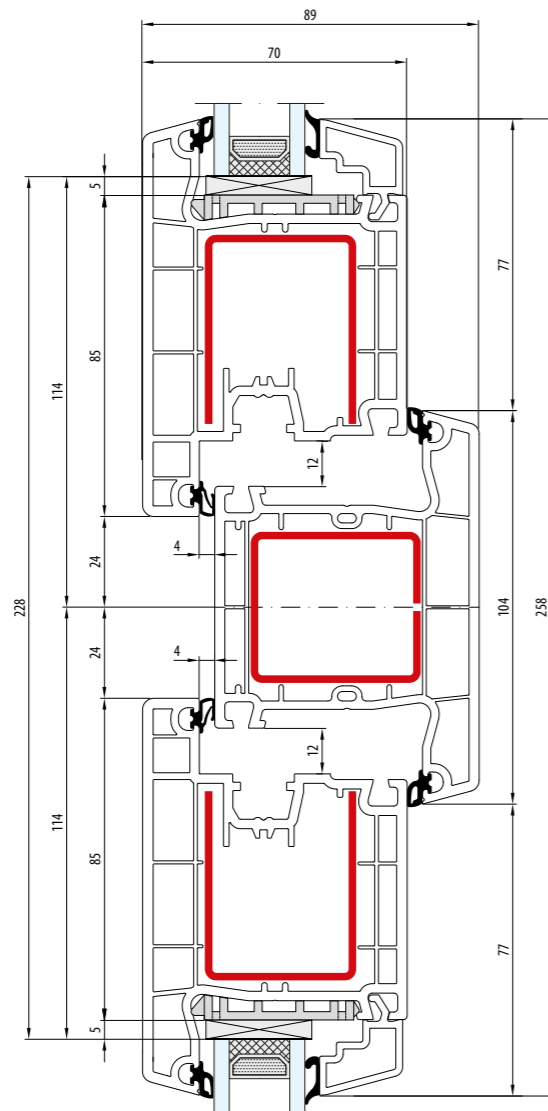

- Słupek stały: 104 mm · Skrzydło: 105 mm
- Meneau fixe: 104 mm · Vantail: 105 mm
- Fix post: 104 mm · Sash: 105 mm
- Festem Pfahl: 104 mm · Flügel: 105 mm
- Montante fisso: 104 mm · Anta: 105 mm

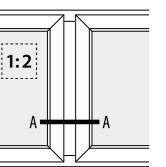
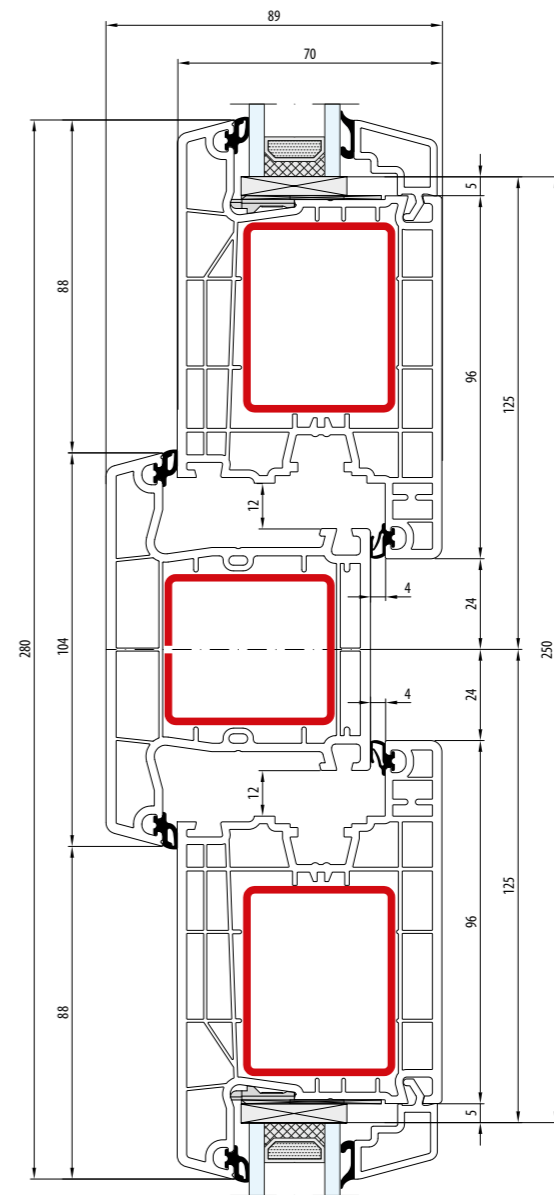

- Słupek stały: 104 mm · Skrzydło: 116 mm
- Meneau fixe: 104 mm · Vantail: 116 mm
- Fix post: 104 mm · Sash: 116 mm
- Festem Pfahl: 104 mm · Flügel: 116 mm
- Montante fisso: 104 mm · Anta: 116 mm

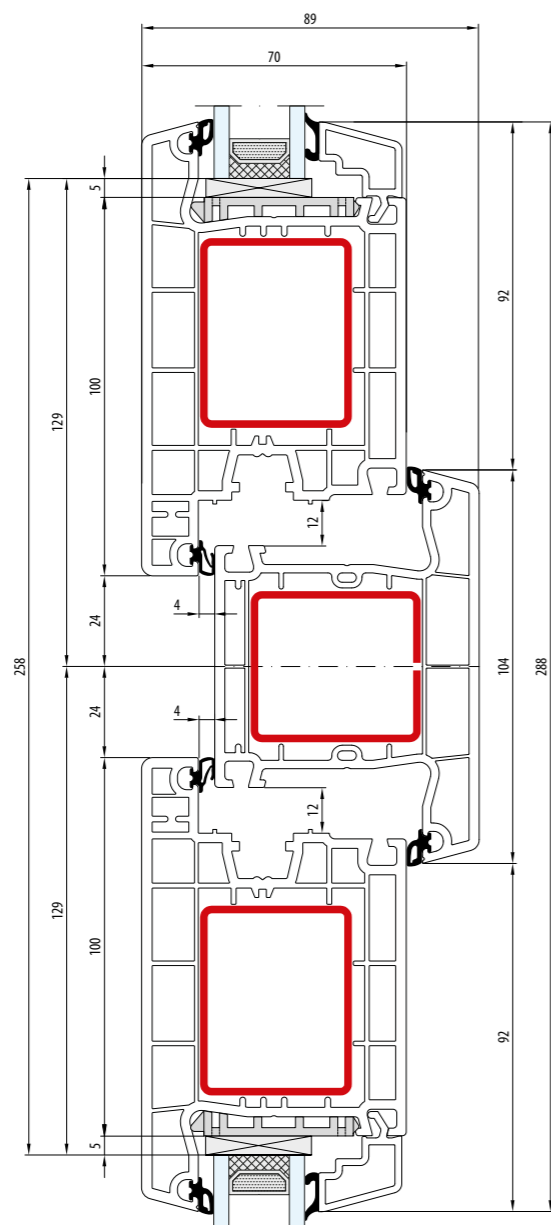

- Słupek stały: 104 mm · Skrzydło: 120 mm
- Meneau fixe: 104 mm · Vantail: 120 mm
- Fix post: 104 mm · Sash: 120 mm
- Festem Pfahl: 104 mm · Flügel: 120 mm
- Montante fissa: 104 mm · Anta: 120 mm

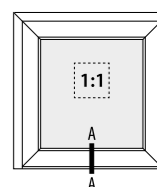
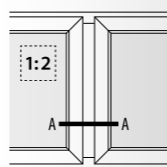

A

A

1:1

1:1

A

A

1:1

1:1

A

A

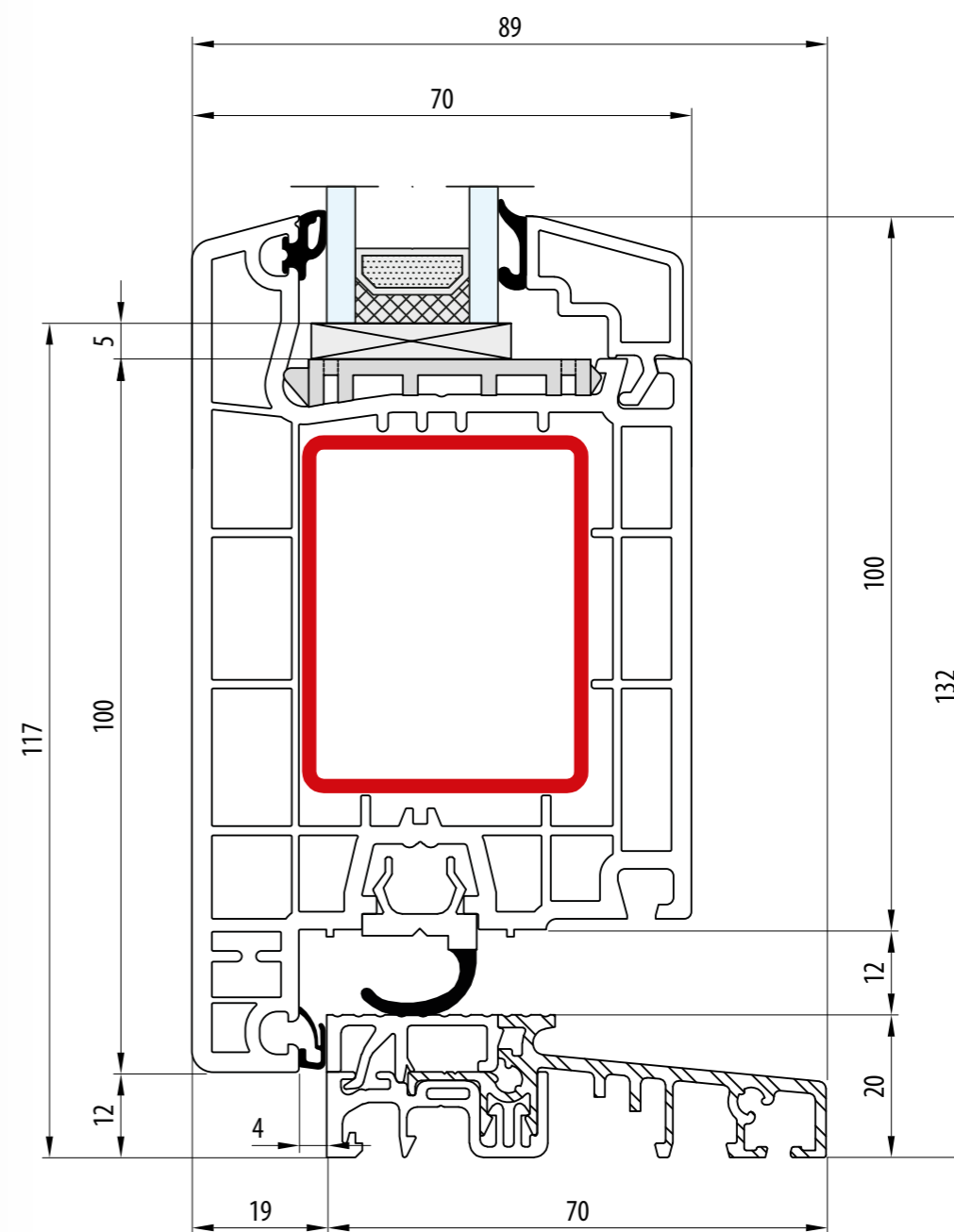

- Próg: 20 mm · Skrzydło: 120 mm
- Seuil: 20 mm · Vantail: 120 mm
- Threshold: 20 mm · Sash: 120 mm
- Schwelle: 20 mm · Flügel: 120 mm
- Soglia: 20 mm · Anta: 120 mm

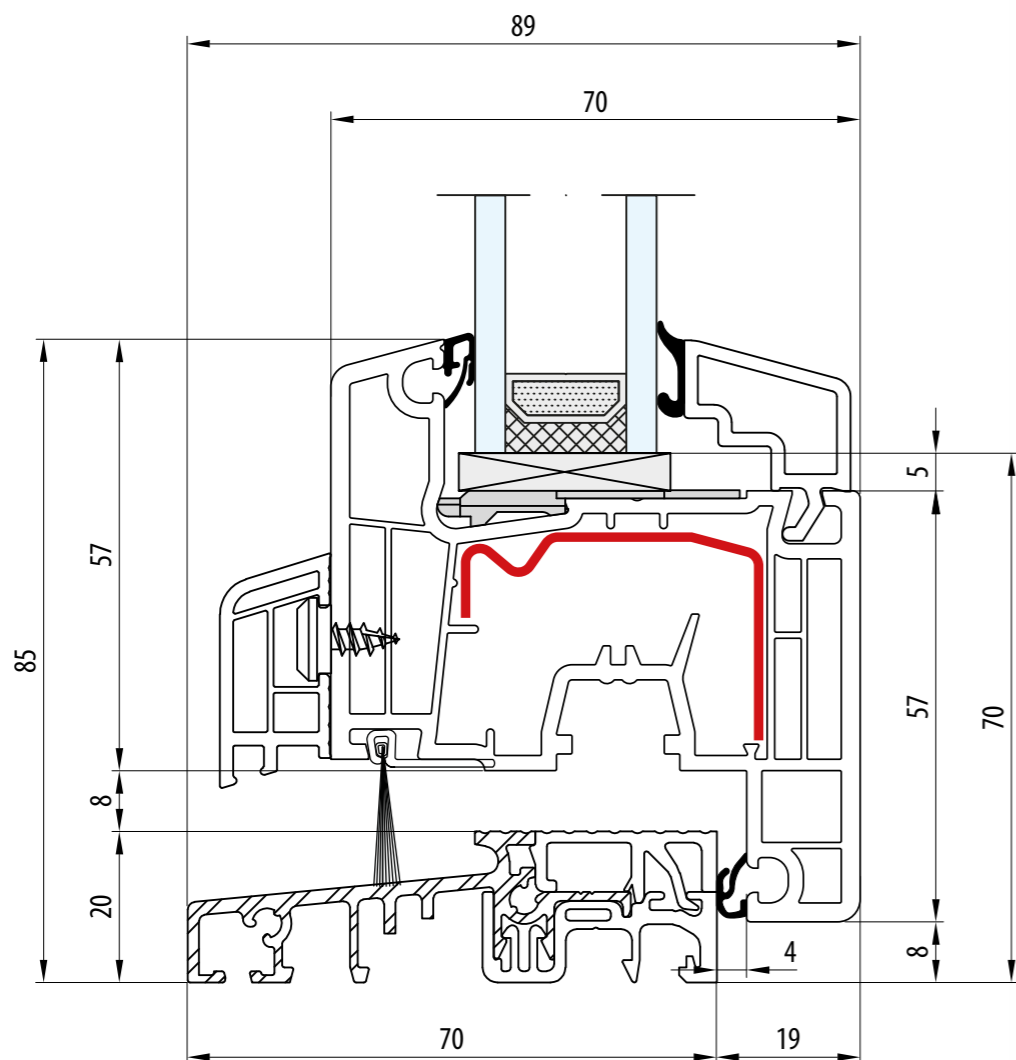

- Próg: 20 mm · Skrzydło: 77 mm
- Seuil: 20 mm · Vantail: 77 mm
- Threshold: 20 mm · Sash: 77 mm
- Schwelle: 20 mm · Flügel: 77 mm
- Soglia: 20 mm · Anta: 77 mm

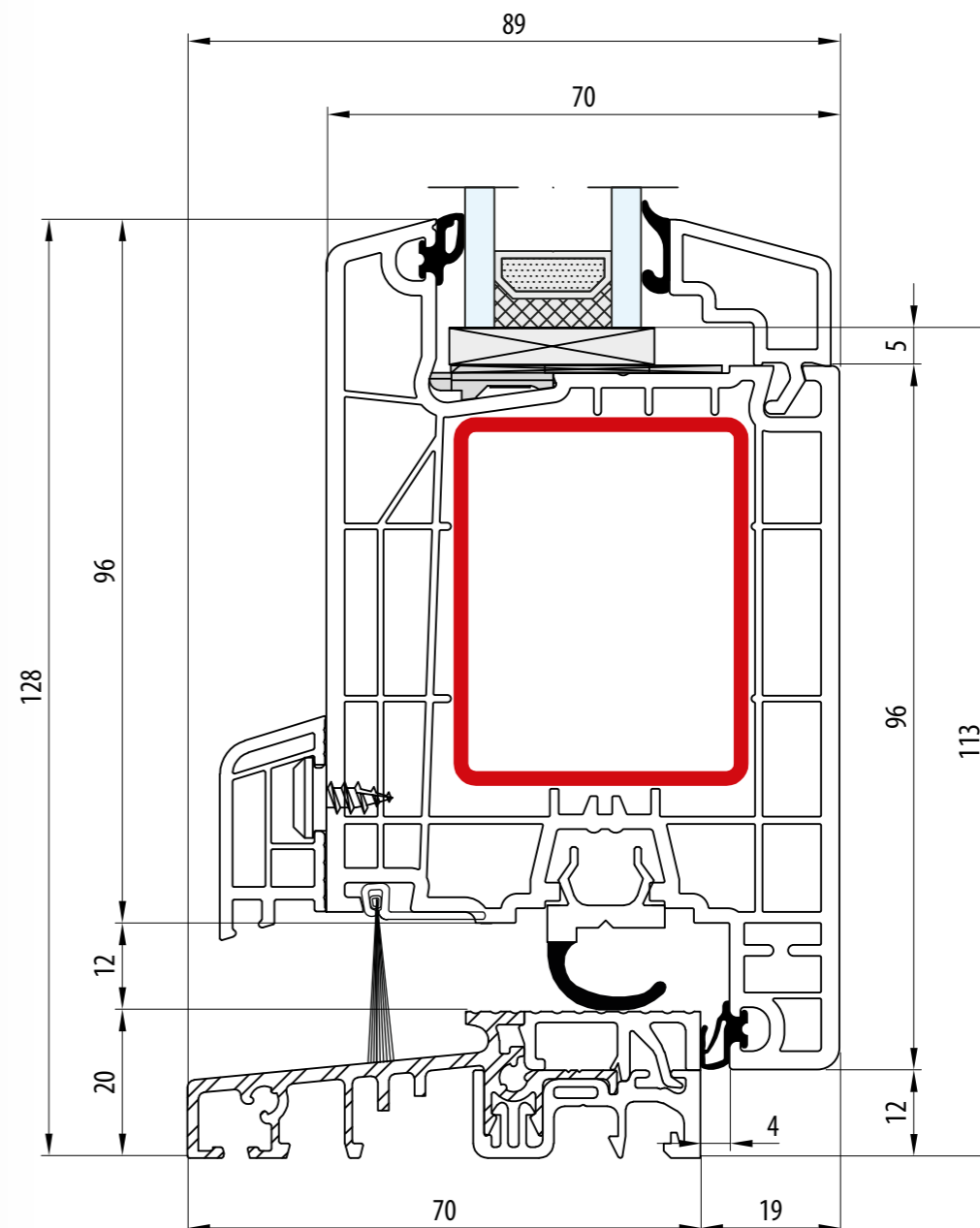
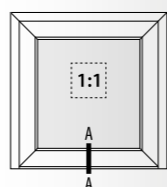



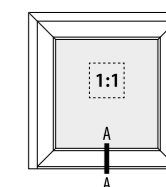

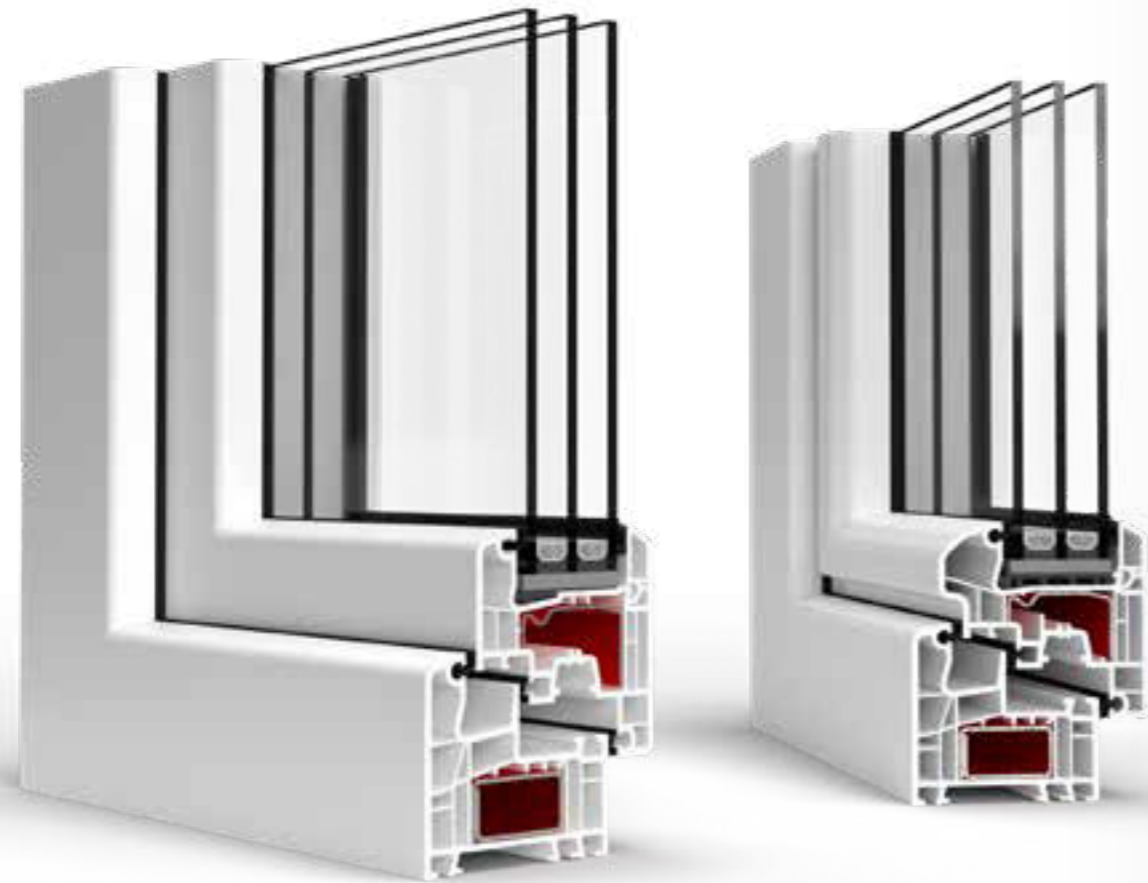

- Próg: 20 mm · Skrzydło: 116 mm
- Seuil: 20 mm · Vantail: 116 mm
- Threshold: 20 mm · Sash: 116 mm
- Schwelle: 20 mm · Flügel: 116 mm
- Soglia: 20 mm · Anta: 116 mm

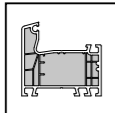

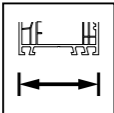
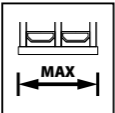
IDEAL 5000

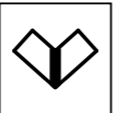

- 
5
- 
3
- 
70
- 
42
- 
V SUPER SOLUTION
- 
V-PERFECT TECHNOLOGY
- 
ALU



IDEAL 4000
 IDEAL 4000 NEW
 IDEAL 5000 +
 IDEAL 7000 NEW
 IDEAL 8000
 ENERGETO 8000

IDEAL 4000
 IDEAL 4000 NEW
 IDEAL 5000 +
 IDEAL 7000 NEW
 IDEAL 8000
 ENERGETO 8000

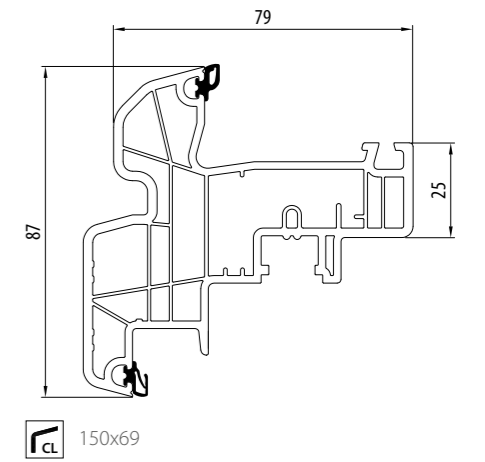
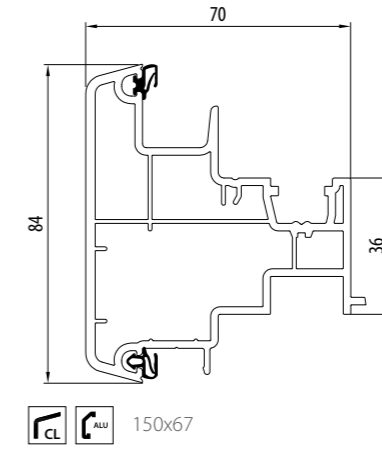
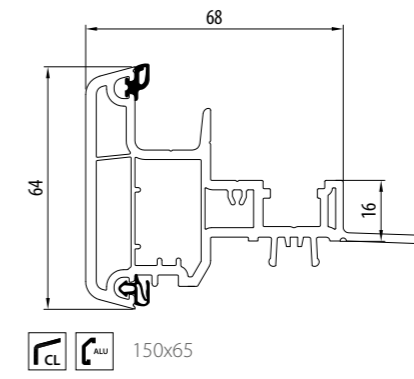
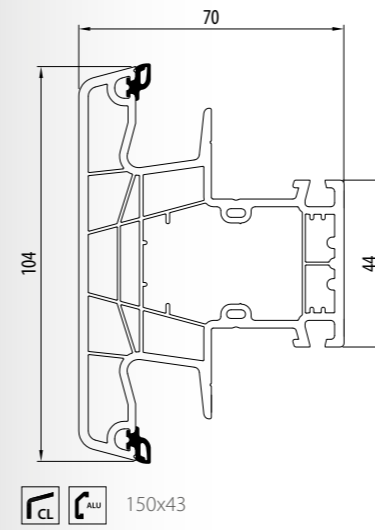
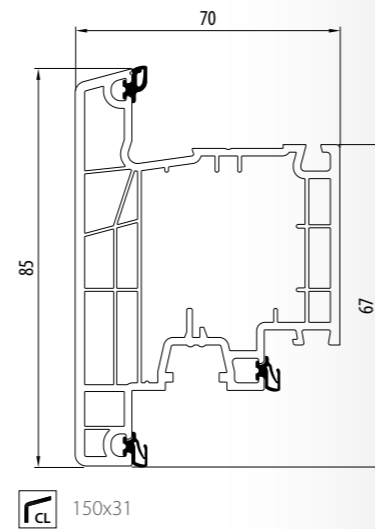
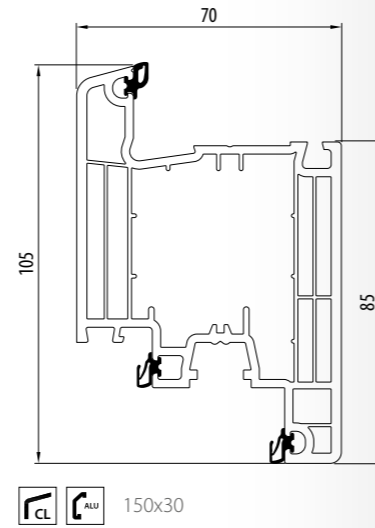
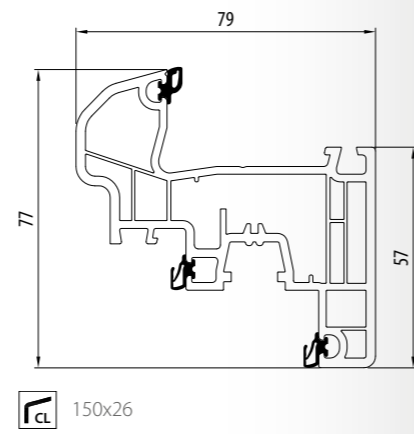
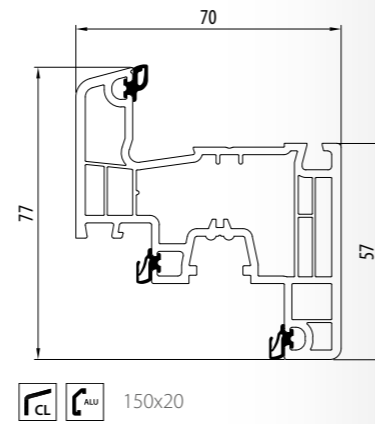
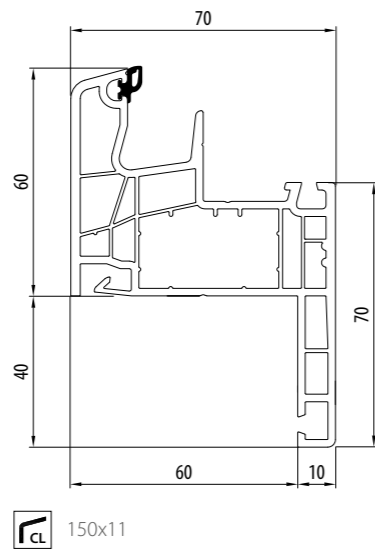
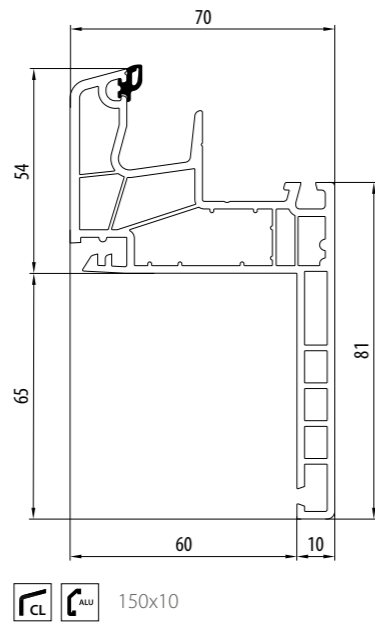
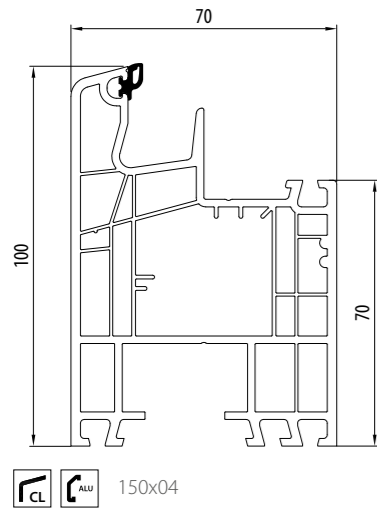
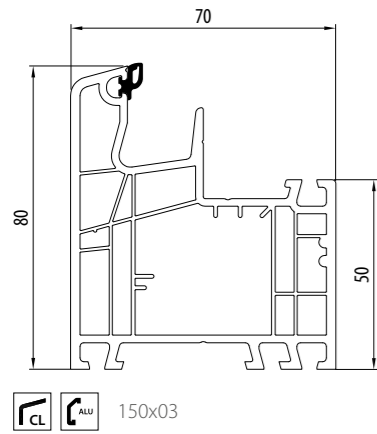
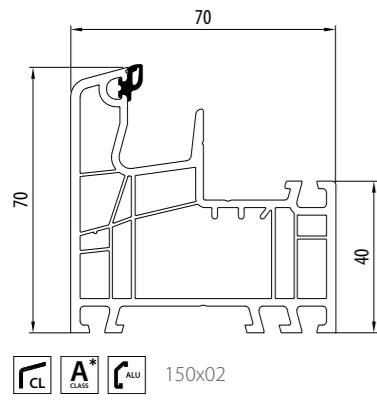

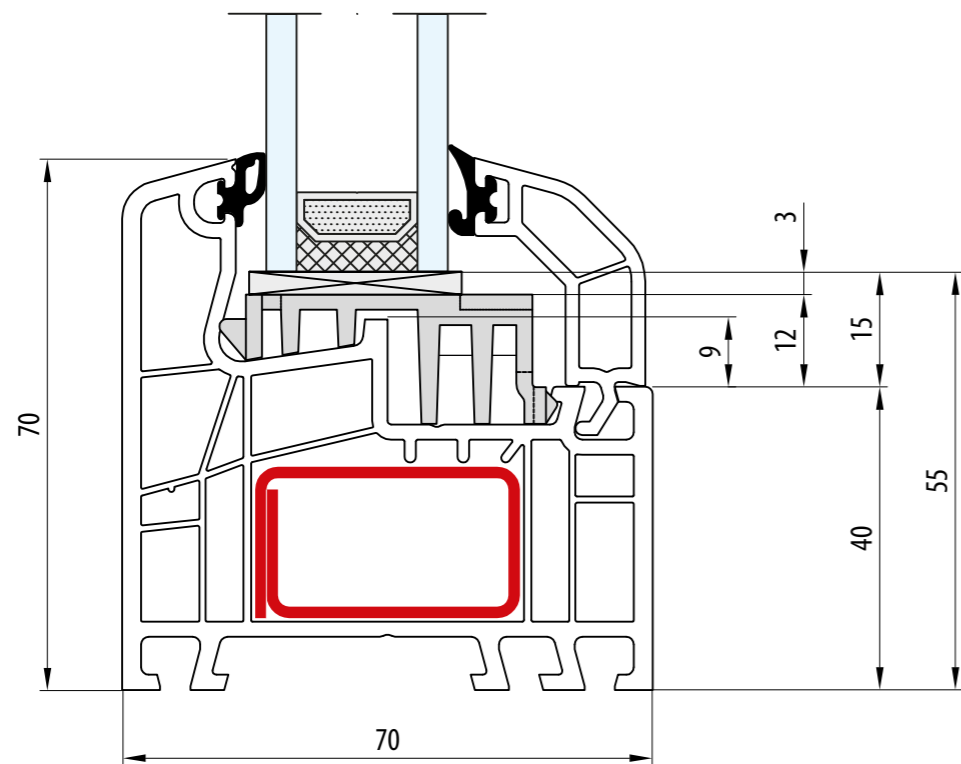
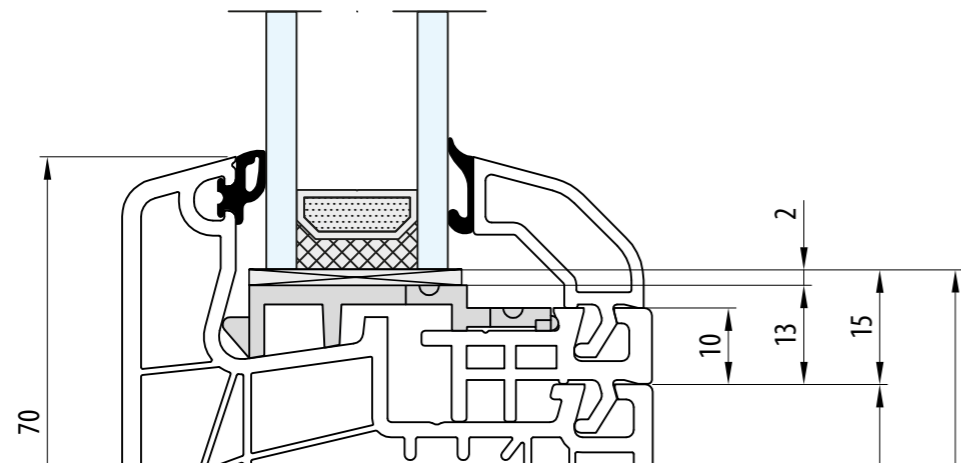

- Rama: 70 mm
- Dormant: 70 mm
- Frame: 70 mm
- Rahmen: 70 mm
- Telaio: 70 mm

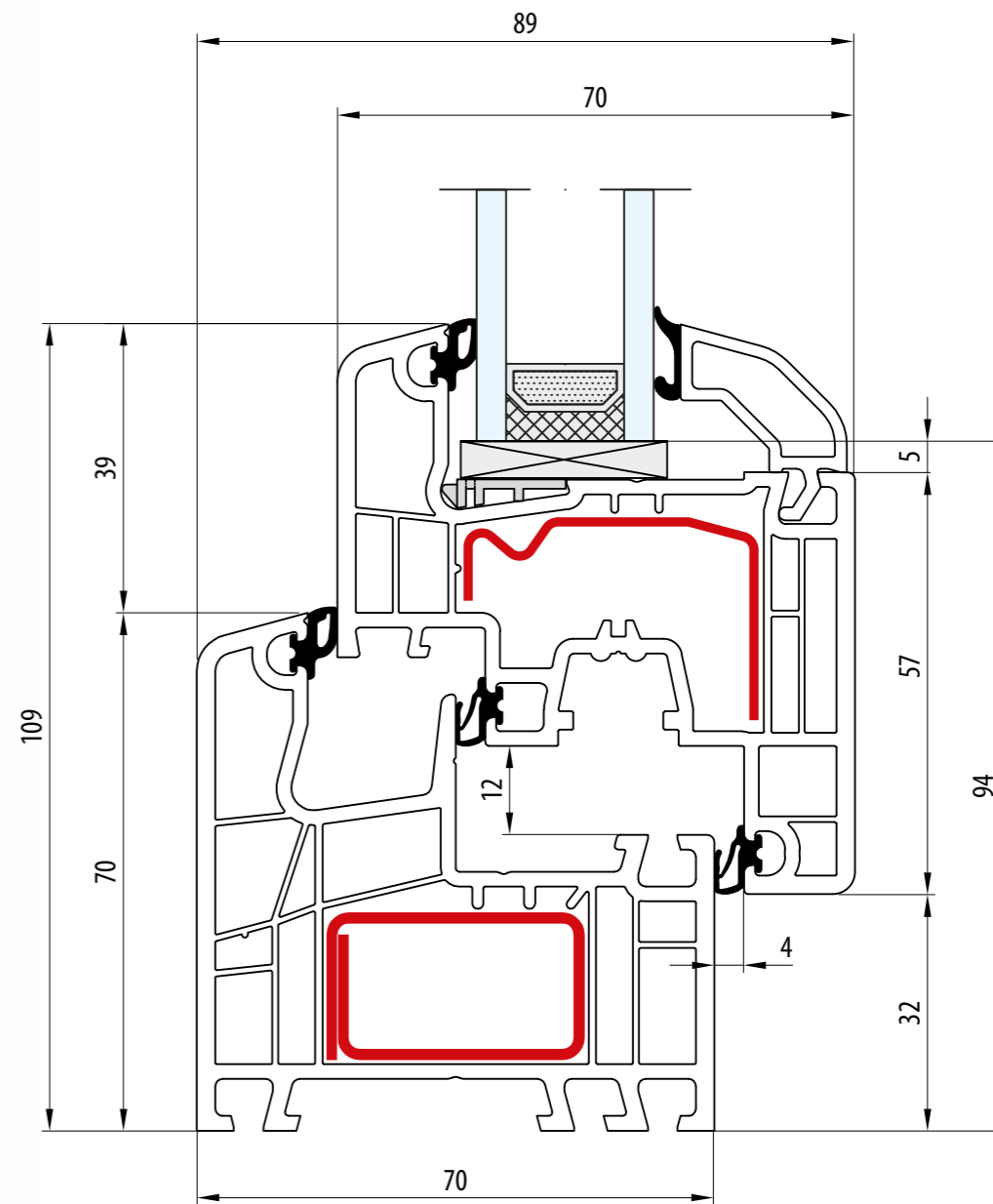
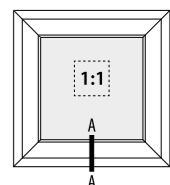
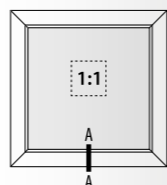

- Rama: 70 mm · Skrzydło: 77 mm
- Dormant: 70 mm · Vantail: 77 mm
- Frame: 70 mm · Sash: 77 mm
- Rahmen: 70 mm · Flügel: 77 mm
- Telaio: 70 mm · Anta: 77 mm

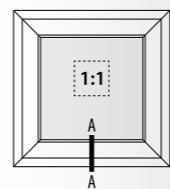
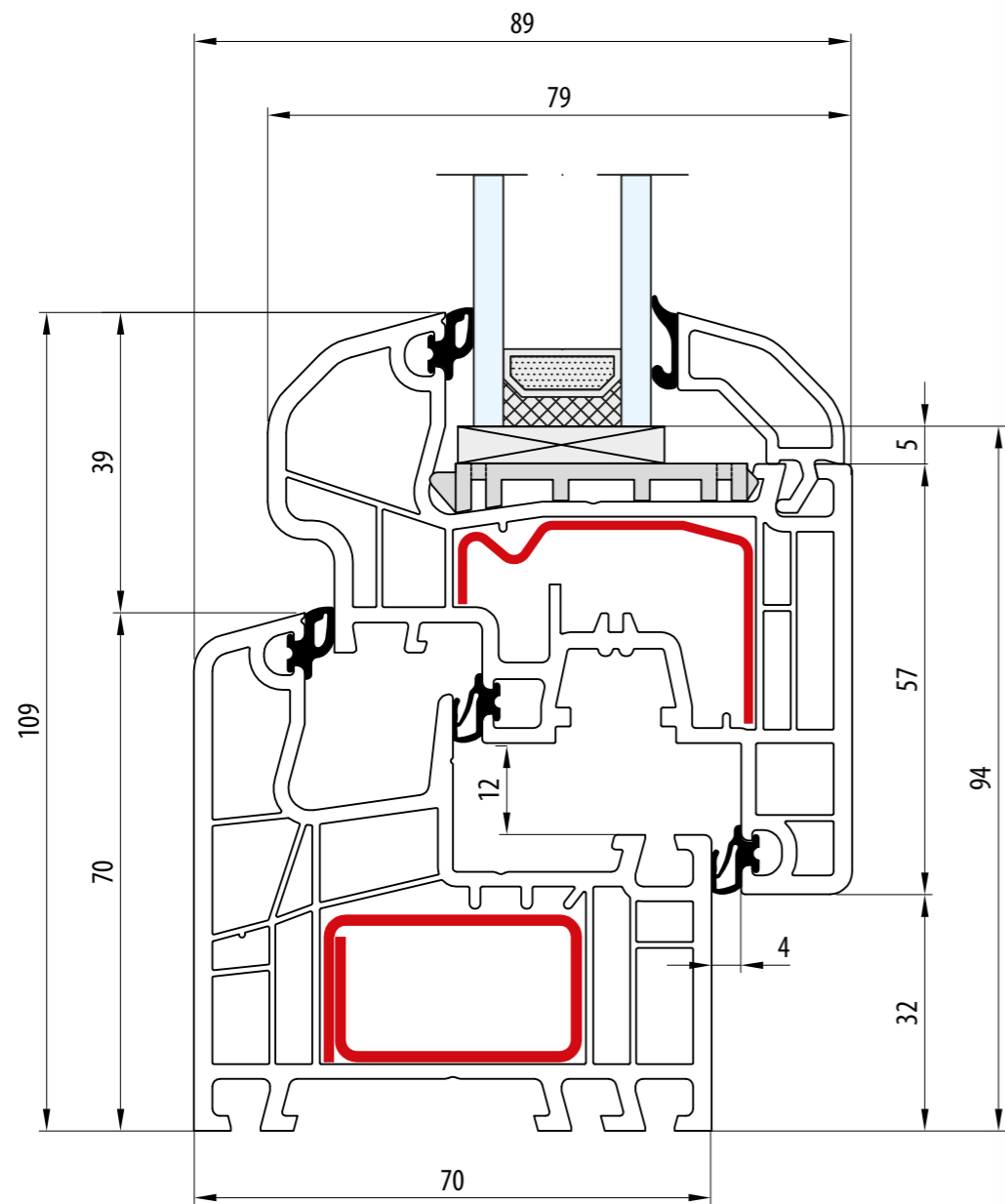

- Rama: 70 mm · Skrzydło: 77 mm
- Dormant: 70 mm · Vantail: 77 mm
- Frame: 70 mm · Sash: 77 mm
- Rahmen: 70 mm · Flügel: 77 mm
- Telaio: 70 mm · Anta: 77 mm

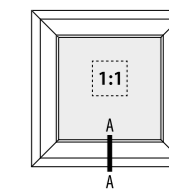
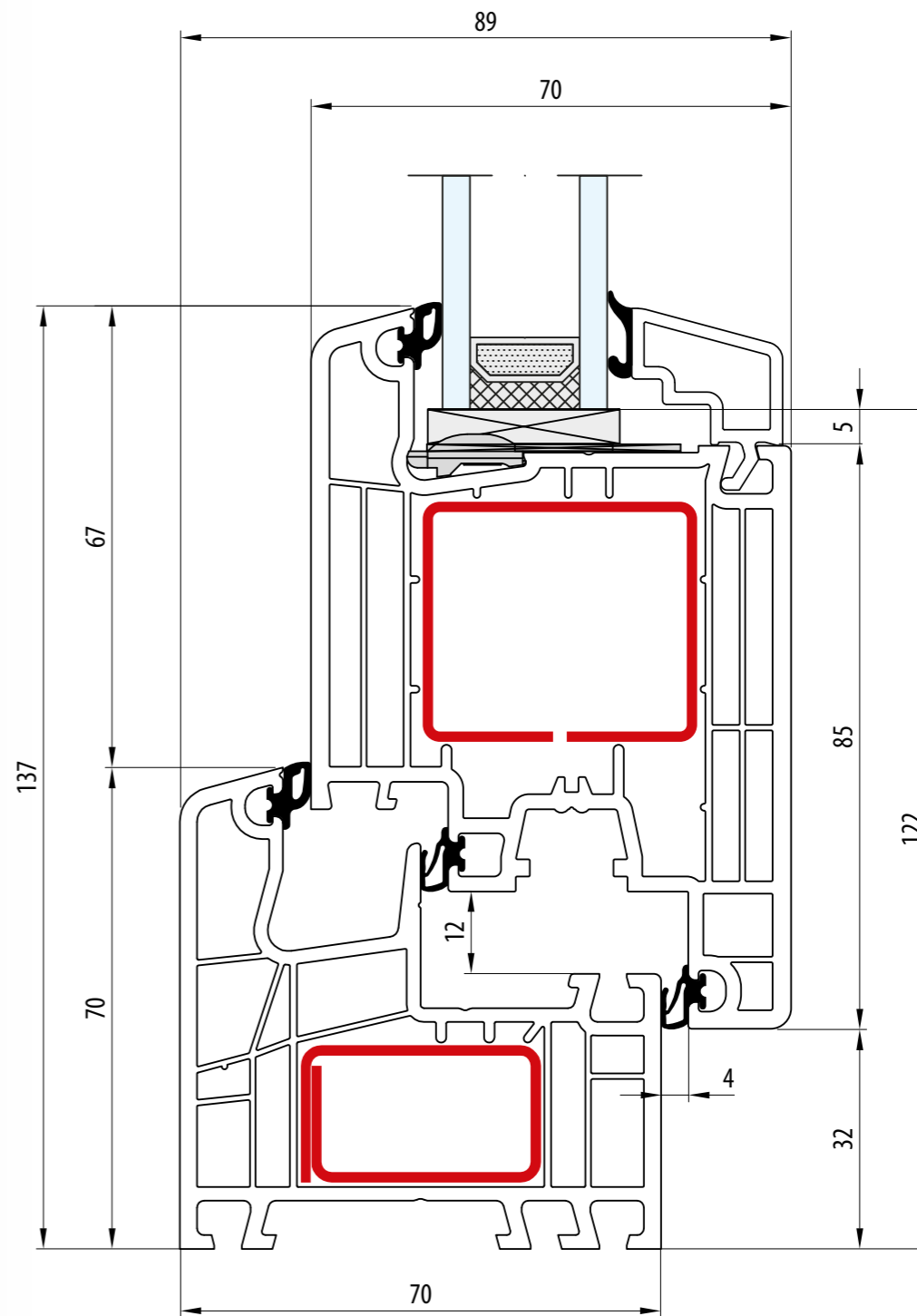

- Rama: 70 mm · Skrzydło: 105 mm
- Dormant: 70 mm · Vantail: 105 mm
- Frame: 70 mm · Sash: 105 mm
- Rahmen: 70 mm · Flügel: 105 mm
- Telaio: 70 mm · Anta: 105 mm

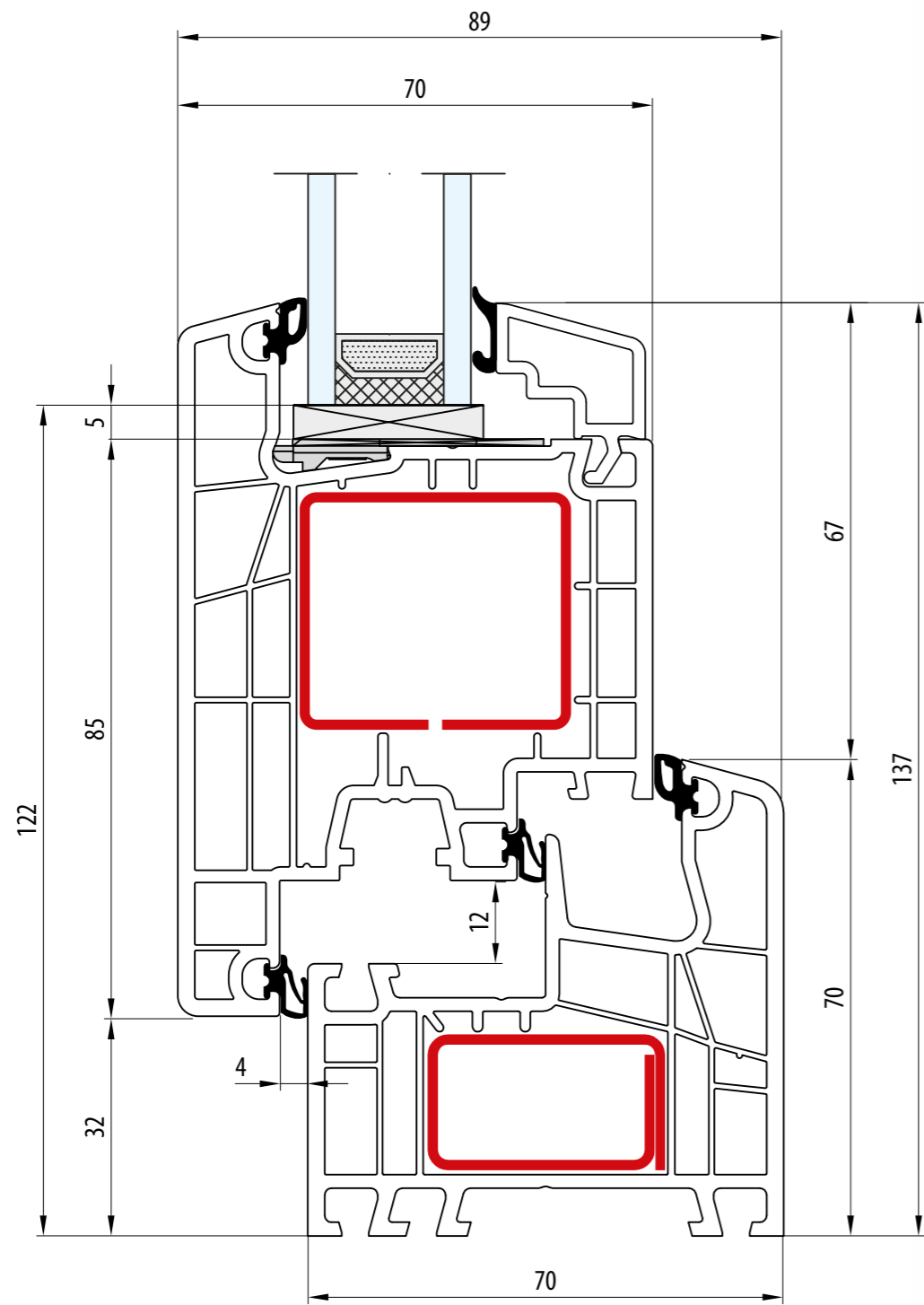

- Rama: 70 mm · Skrzydło: 105 mm
- Dormant: 70 mm · Vantail: 105 mm
- Frame: 70 mm · Sash: 105 mm
- Rahmen: 70 mm · Flügel: 105 mm
- Telaio: 70 mm · Anta: 105 mm

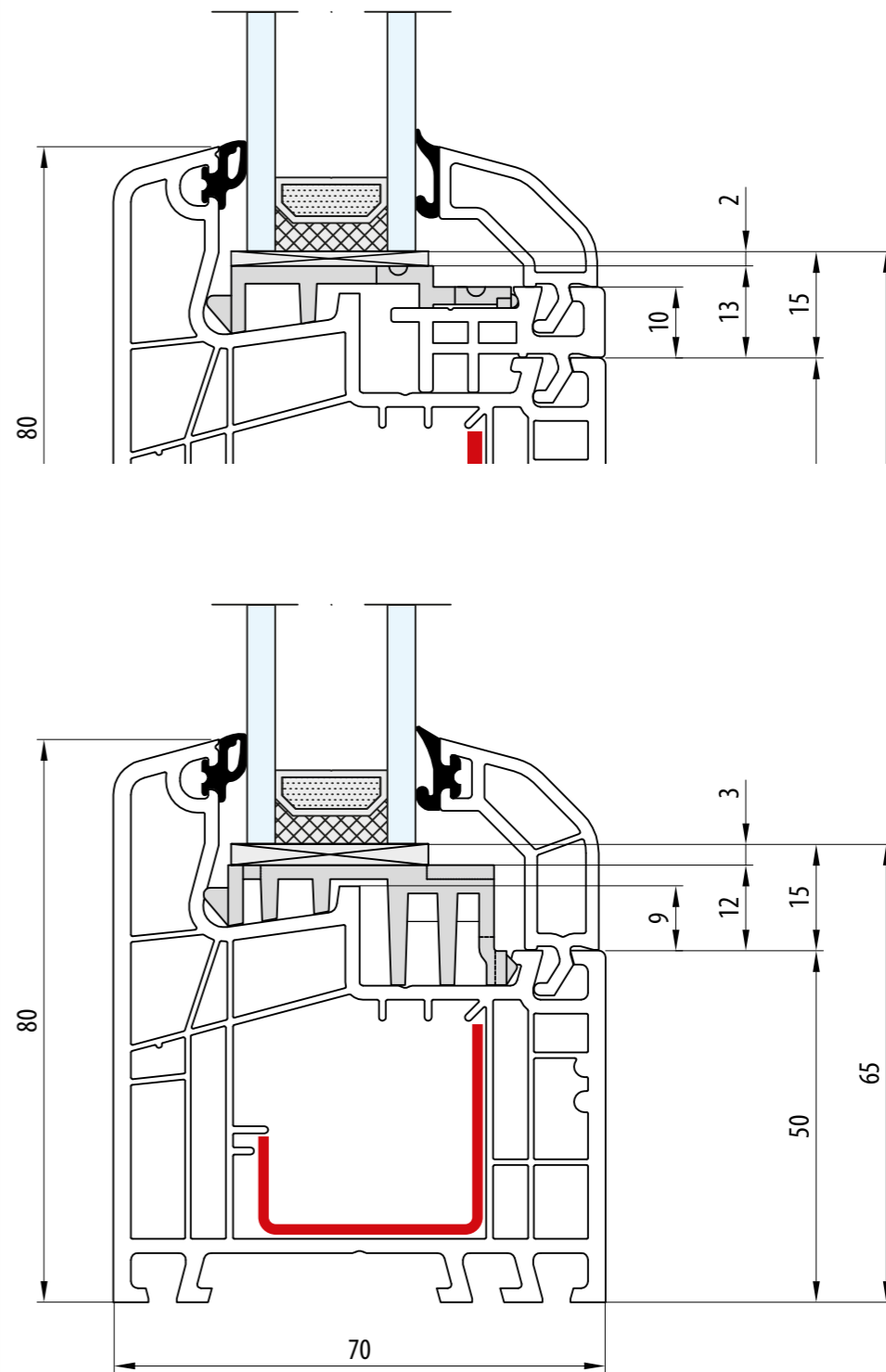
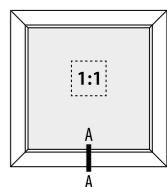
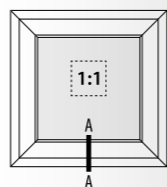

- Rama: 80 mm
- Dormant: 80 mm
- Frame: 80 mm
- Rahmen: 80 mm
- Telaio: 80 mm

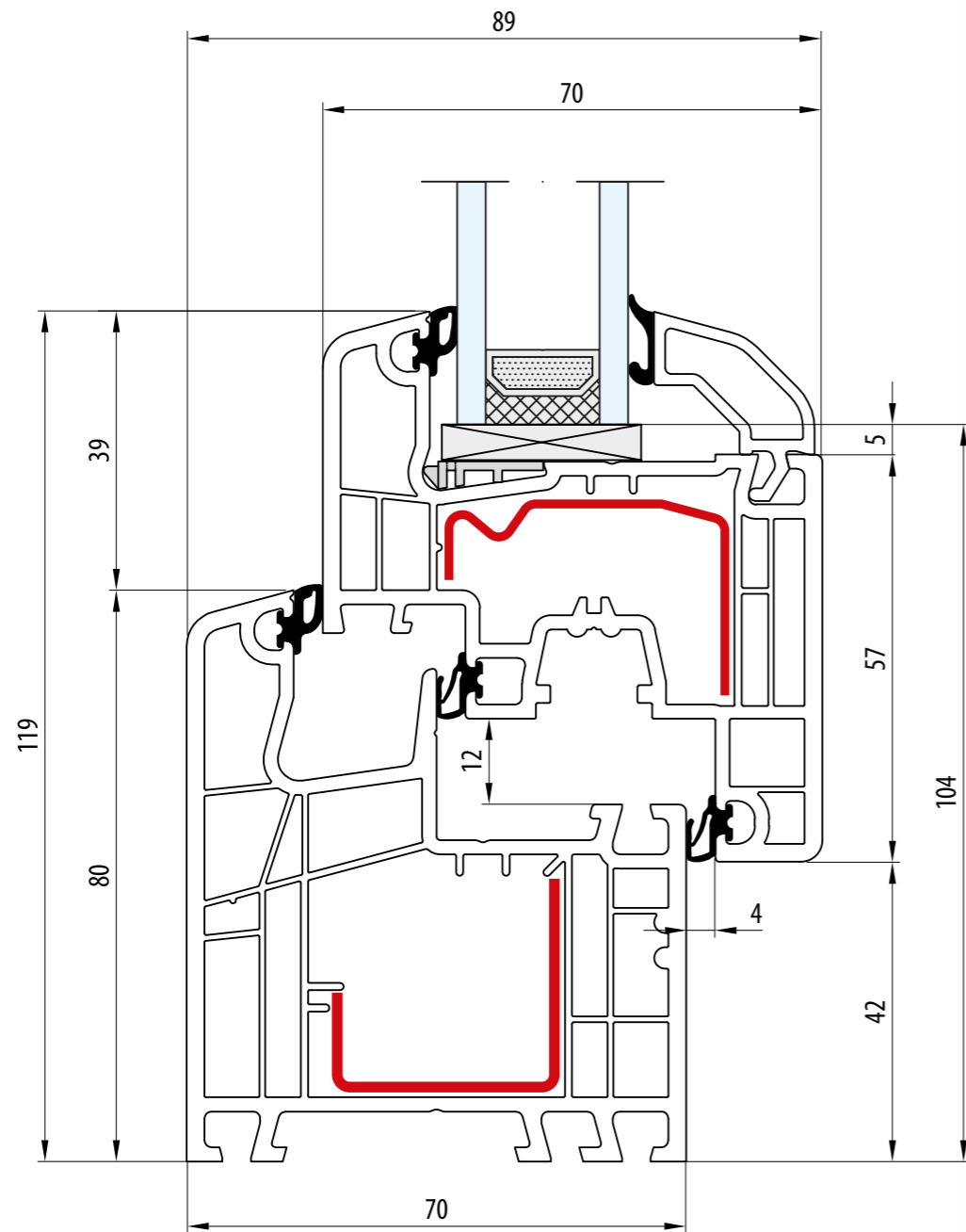

- Rama: 80 mm · Skrzydło: 77 mm
- Dormant: 80 mm · Vantail: 77 mm
- Frame: 80 mm · Sash: 77 mm
- Rahmen: 80 mm · Flügel: 77 mm
- Telaio: 80 mm · Anta: 77 mm

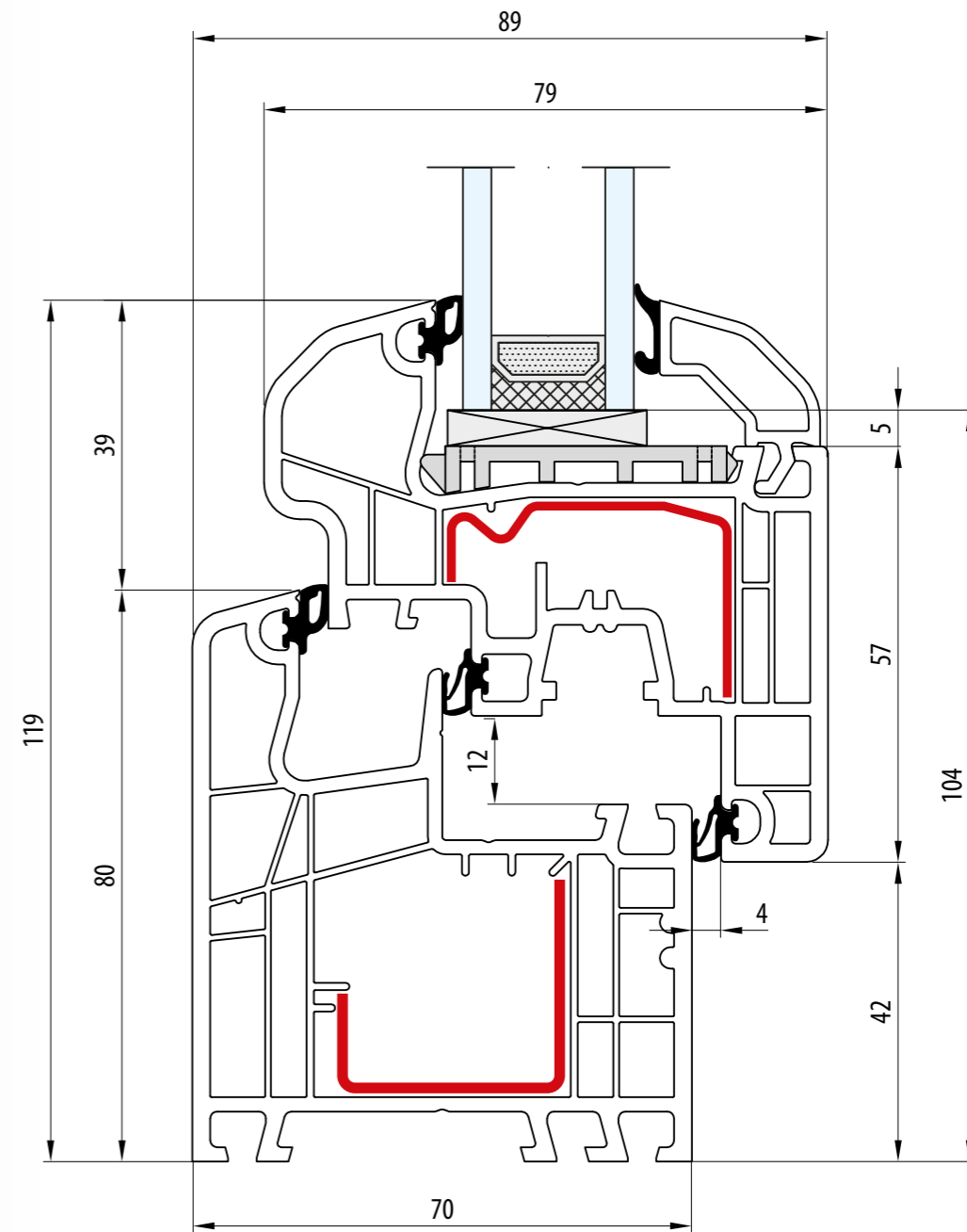
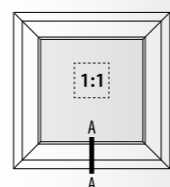

- Rama: 80 mm · Skrzydło: 77 mm
- Dormant: 80 mm · Vantail: 77 mm
- Frame: 80 mm · Sash: 77 mm
- Rahmen: 80 mm · Flügel: 77 mm
- Telaio: 80 mm · Anta: 77 mm

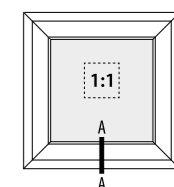

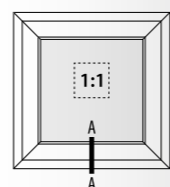
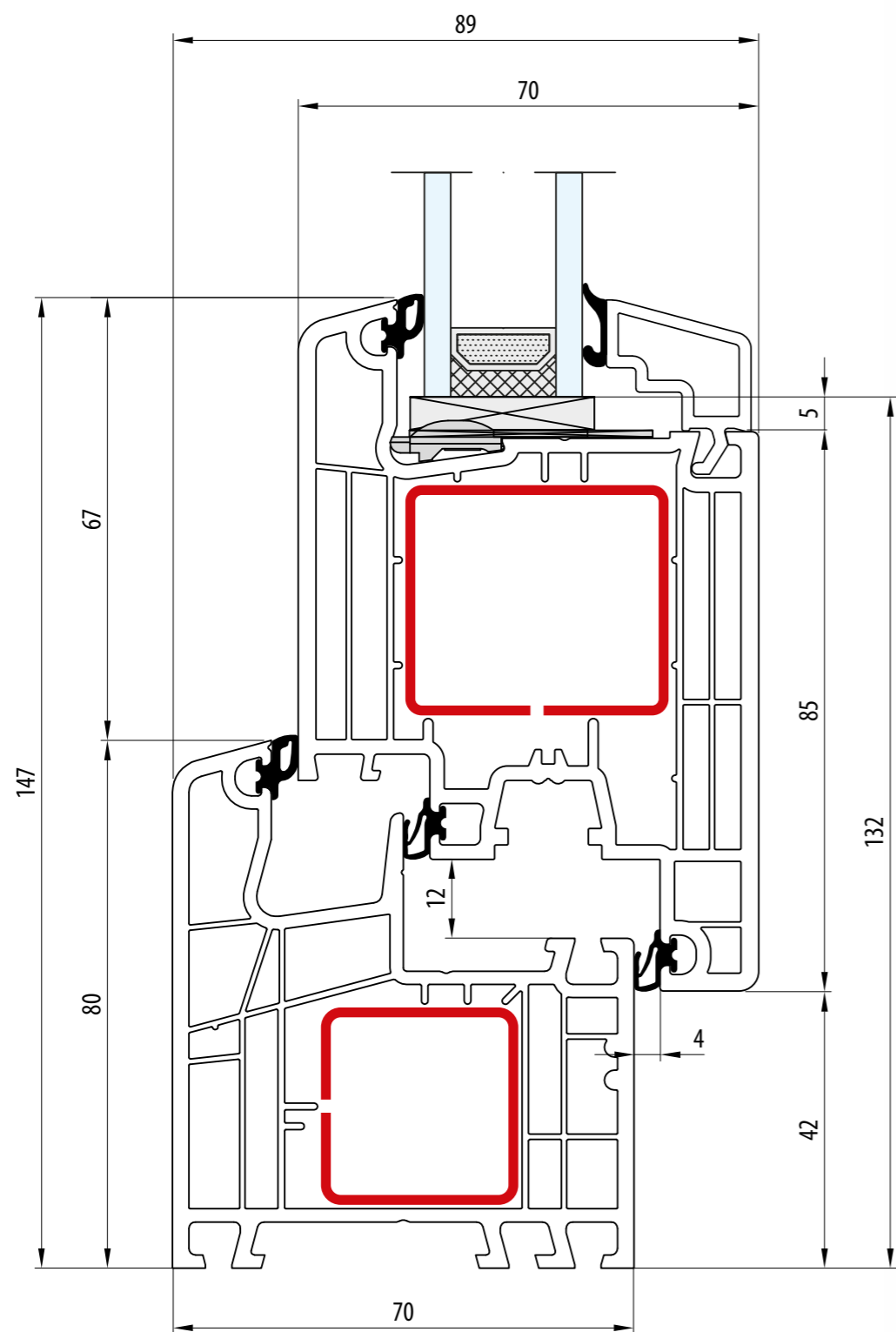

- Rama: 80 mm · Skrzydło: 105 mm
- Dormant: 80 mm · Vantail: 105 mm
- Frame: 80 mm · Sash: 105 mm
- Rahmen: 80 mm · Flügel: 105 mm
- Telaio: 80 mm · Anta: 105 mm

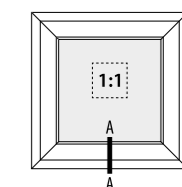
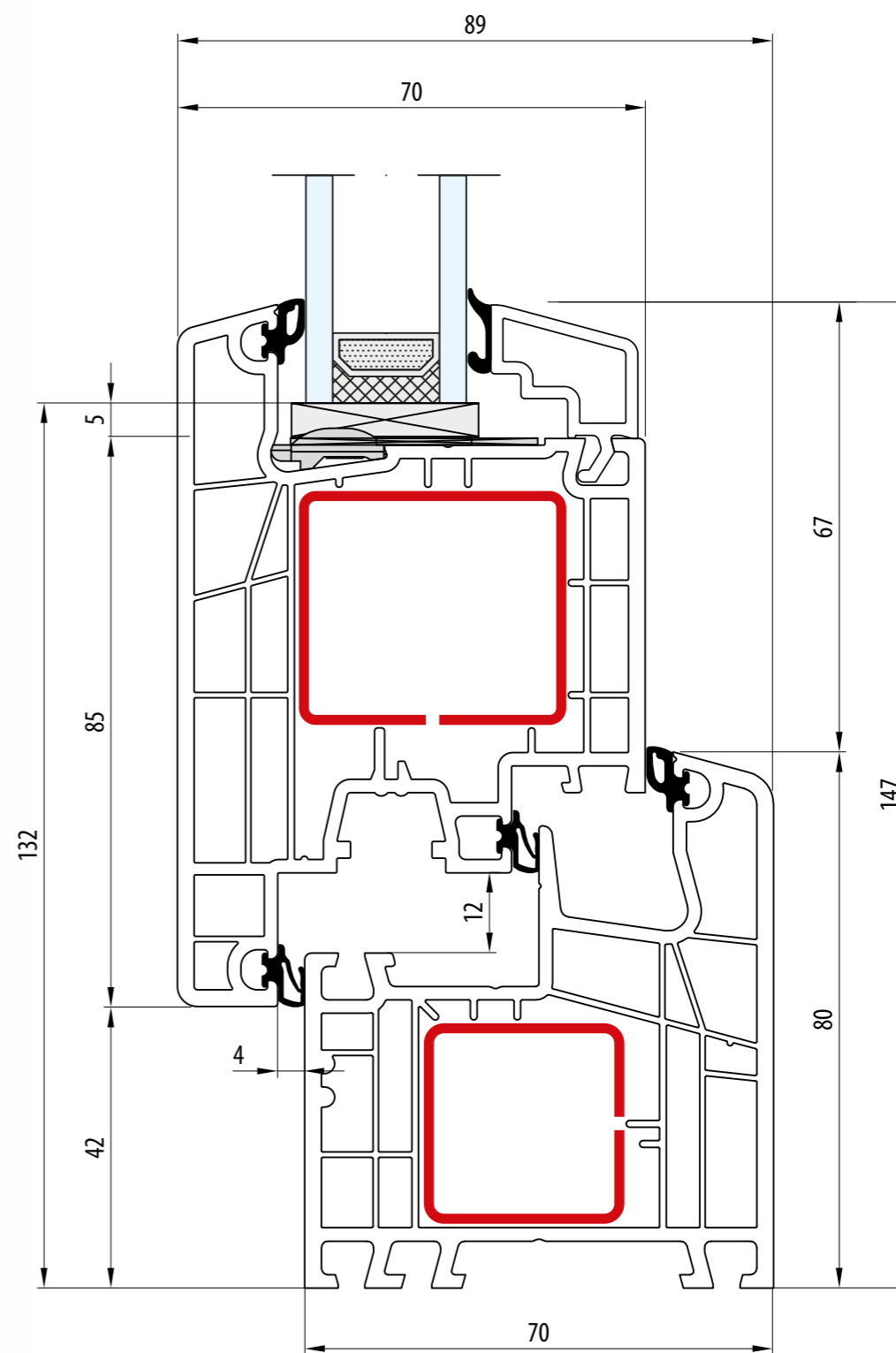

- Rama: 80 mm · Skrzydło: 105 mm
- Dormant: 80 mm · Vantail: 105 mm
- Frame: 80 mm · Sash: 105 mm
- Rahmen: 80 mm · Flügel: 105 mm
- Telaio: 80 mm · Anta: 105 mm

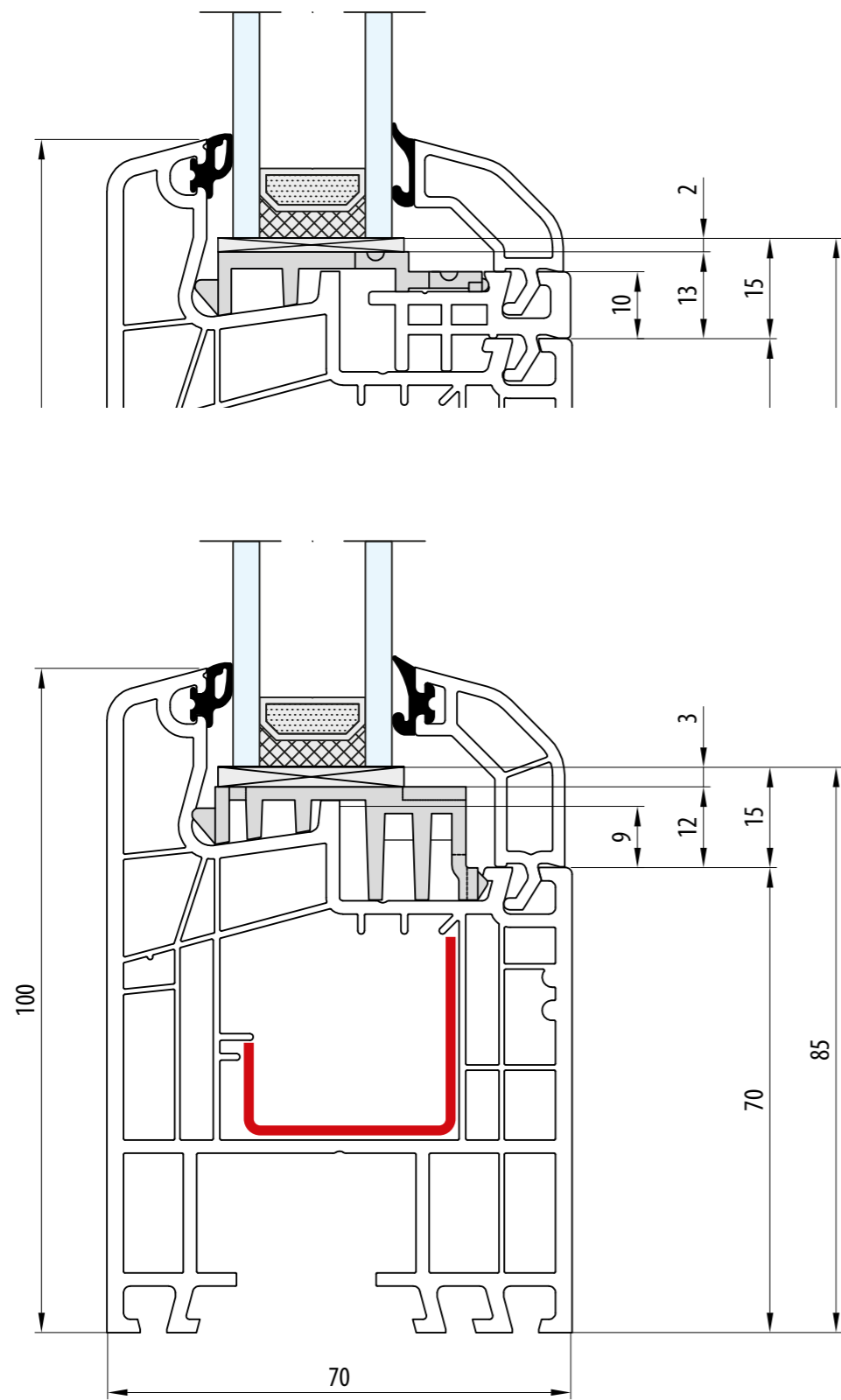

- Rama: 100 mm
- Dormant: 100 mm
- Frame: 100 mm
- Rahmen: 100 mm
- Telaio: 100 mm

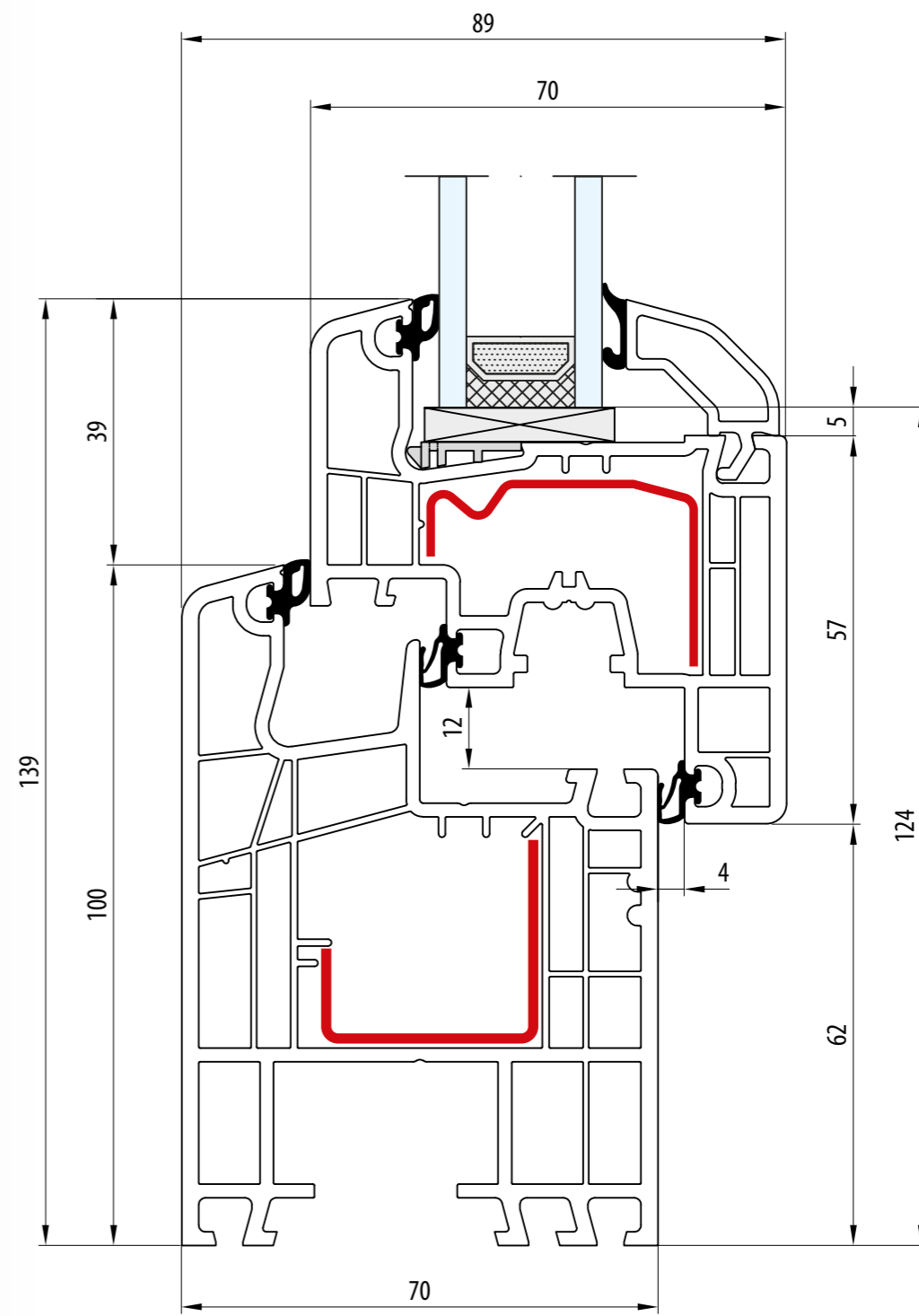
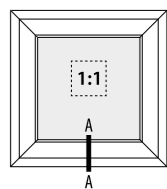
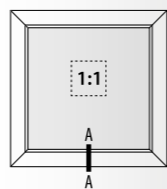

- Rama: 100 mm · Skrzydło: 77 mm
- Dormant: 100 mm · Vantail: 77 mm
- Frame: 100 mm · Sash: 77 mm
- Rahmen: 100 mm · Flügel: 77 mm
- Telaio: 100 mm · Anta: 77 mm

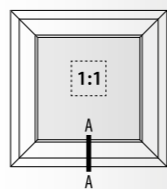
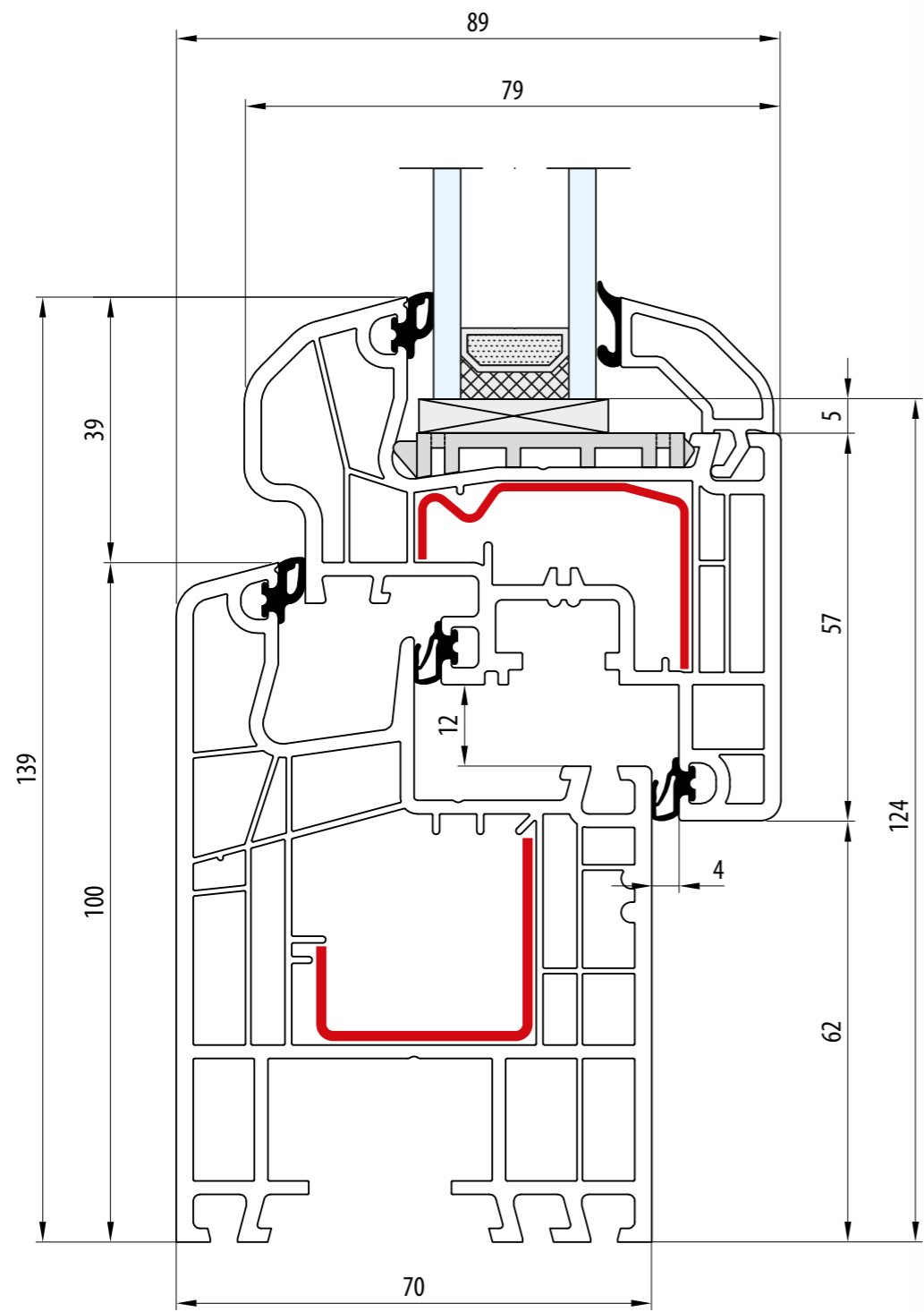

- Rama: 100 mm · Skrzydło: 77 mm
- Dormant: 100 mm · Vantail: 77 mm
- Frame: 100 mm · Sash: 77 mm
- Rahmen: 100 mm · Flügel: 77 mm
- Telaio: 100 mm · Anta: 77 mm

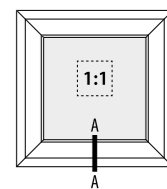
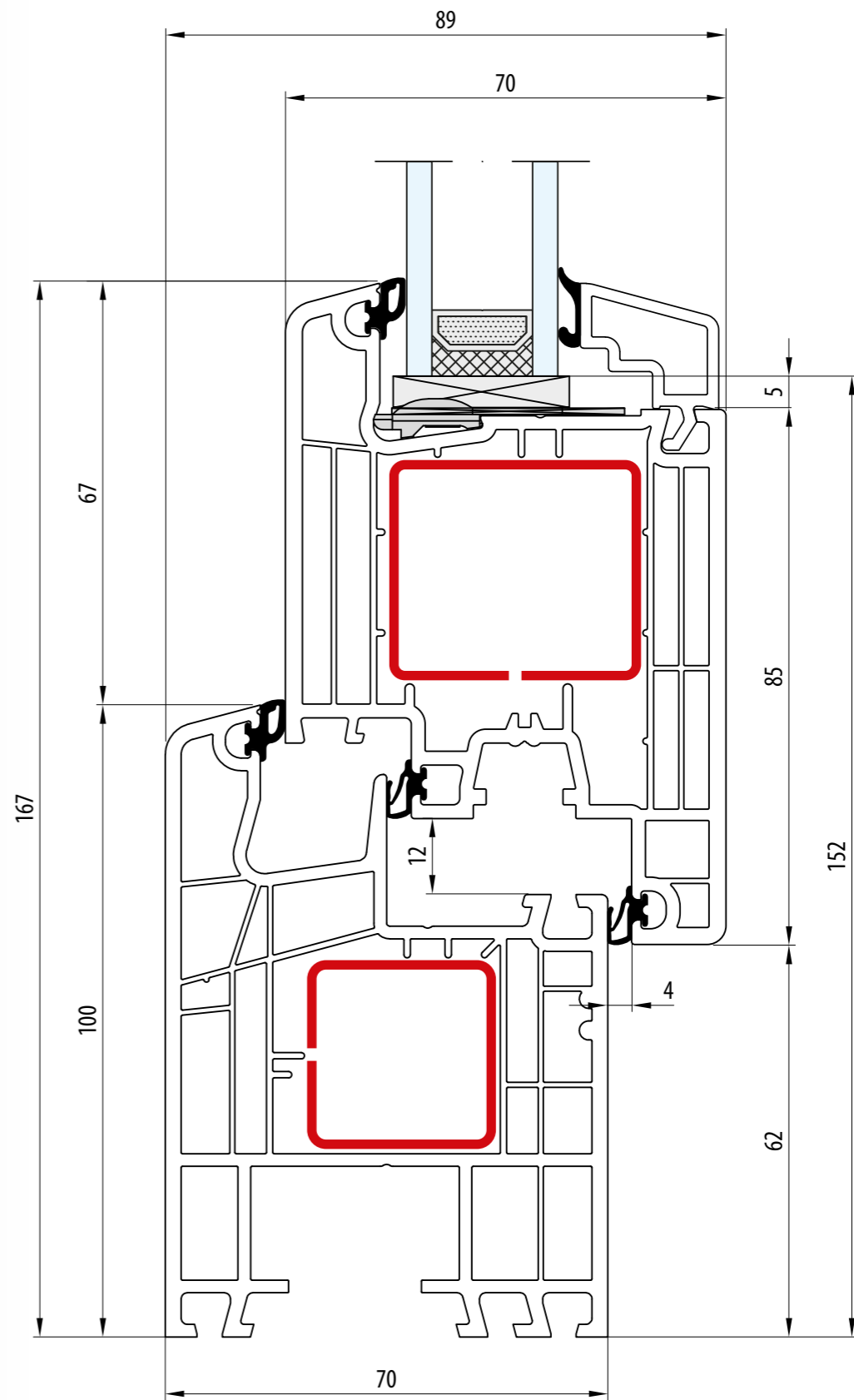

- Rama: 100 mm · Skrzydło: 105 mm
- Dormant: 100 mm · Vantail: 105 mm
- Frame: 100 mm · Sash: 105 mm
- Rahmen: 100 mm · Flügel: 105 mm
- Telaio: 100 mm · Anta: 105 mm

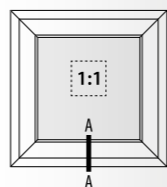
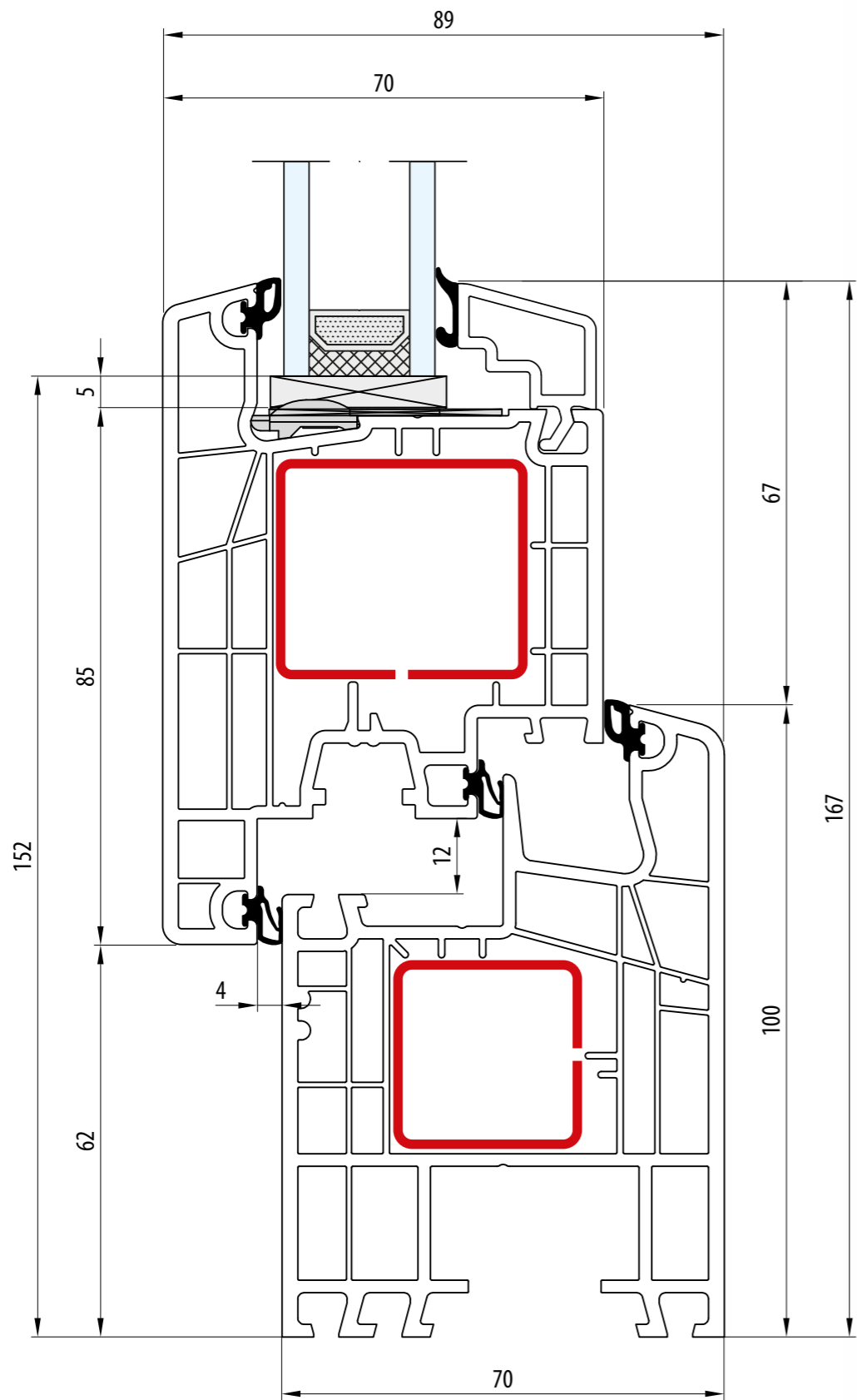

- Rama: 100 mm · Skrzydło: 105 mm
- Dormant: 100 mm · Vantail: 105 mm
- Frame: 100 mm · Sash: 105 mm
- Rahmen: 100 mm · Flügel: 105 mm
- Telaio: 100 mm · Anta: 105 mm

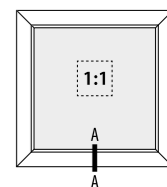
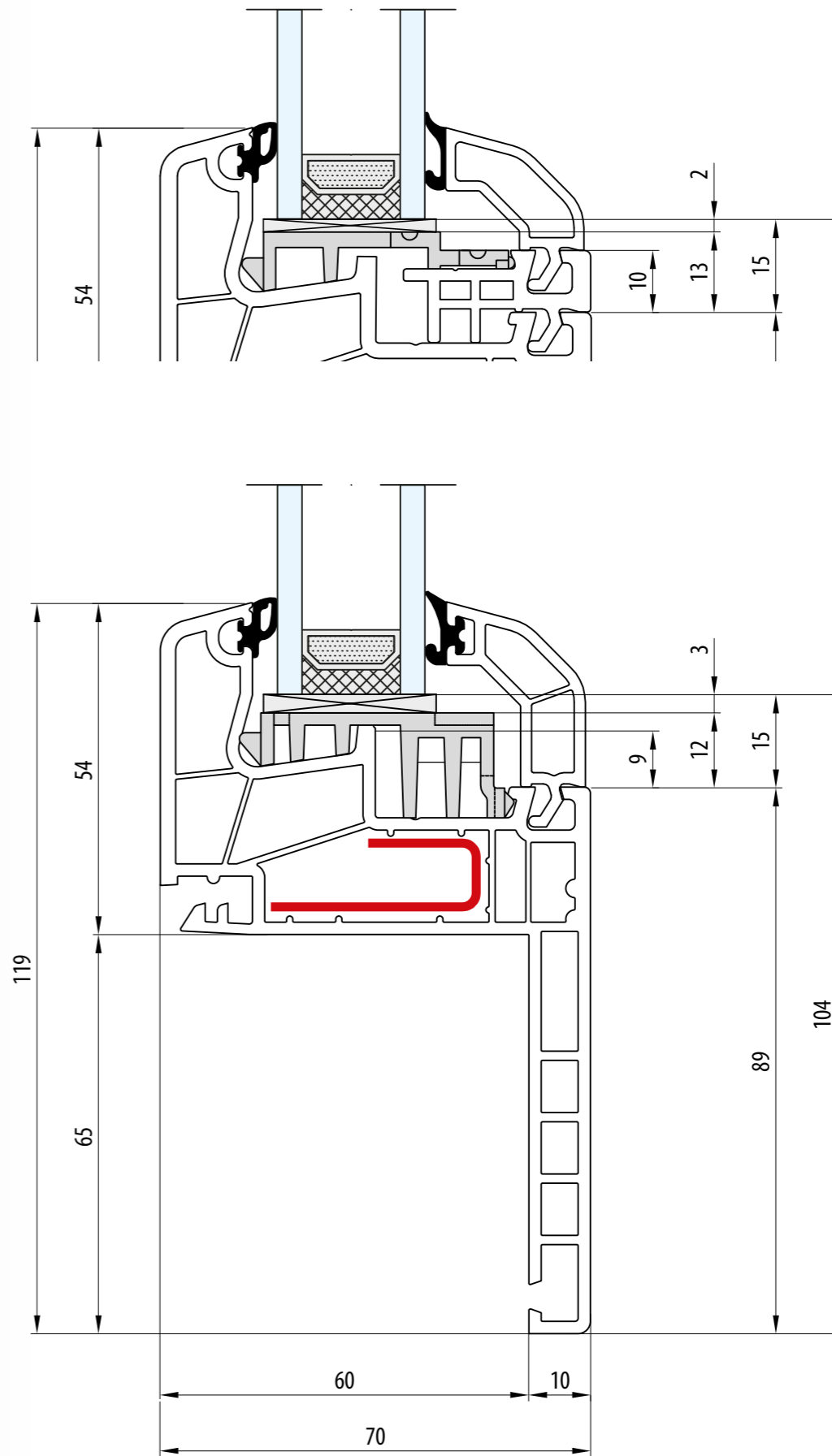

- RENOWACJA - Pletwa: 65 mm · Rama: 54 mm
- RÉNOVATION - Lip: 65 mm · Dormant: 54 mm
- RENOVATION - Strip: 65 mm · Frame: 54 mm
- RENOVIERUNG - Flosse: 65 mm · Rahmen: 54 mm
- RINNOVAZIONE - Aletta da: 65 mm · Telaio: 54 mm

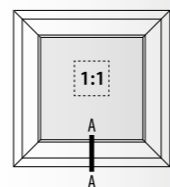
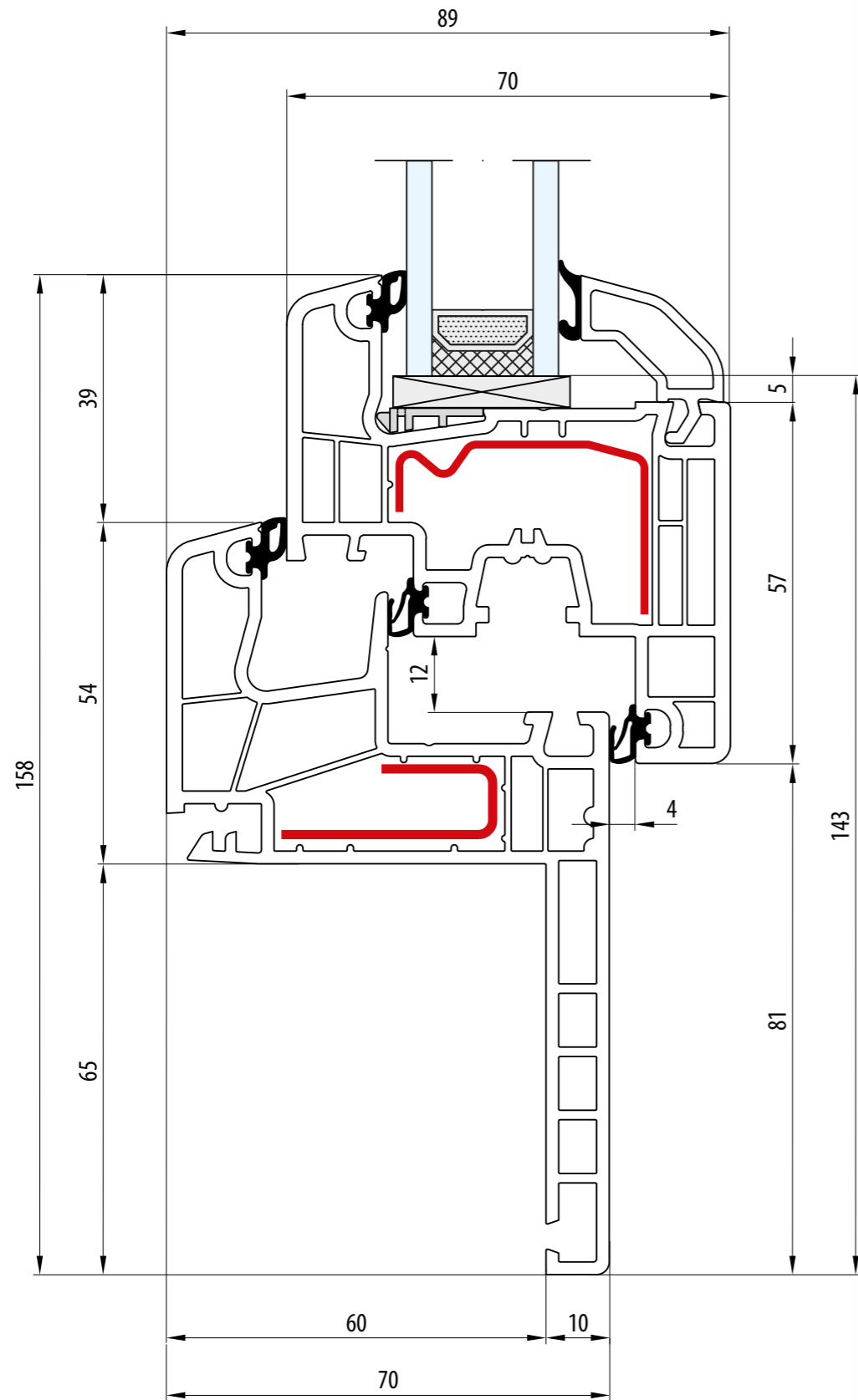

- RENOWACJA - Pletwa: 65 mm · Rama: 54 mm · Skrzydło: 77 mm
- RÉNOVATION - Lip: 65 mm · Dormant: 54 mm · Vantail: 77 mm
- RENOVATION - Strip: 65 mm · Frame: 54 mm · Sash: 77 mm
- RENOVIERUNG - Flosse: 65 mm · Rahmen: 54 mm · Flügel: 77 mm
- RINNOVAZIONE - Aletta da: 65 mm · Telaio: 54 mm · Anta: 77 mm

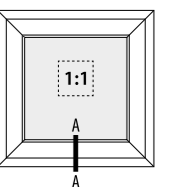
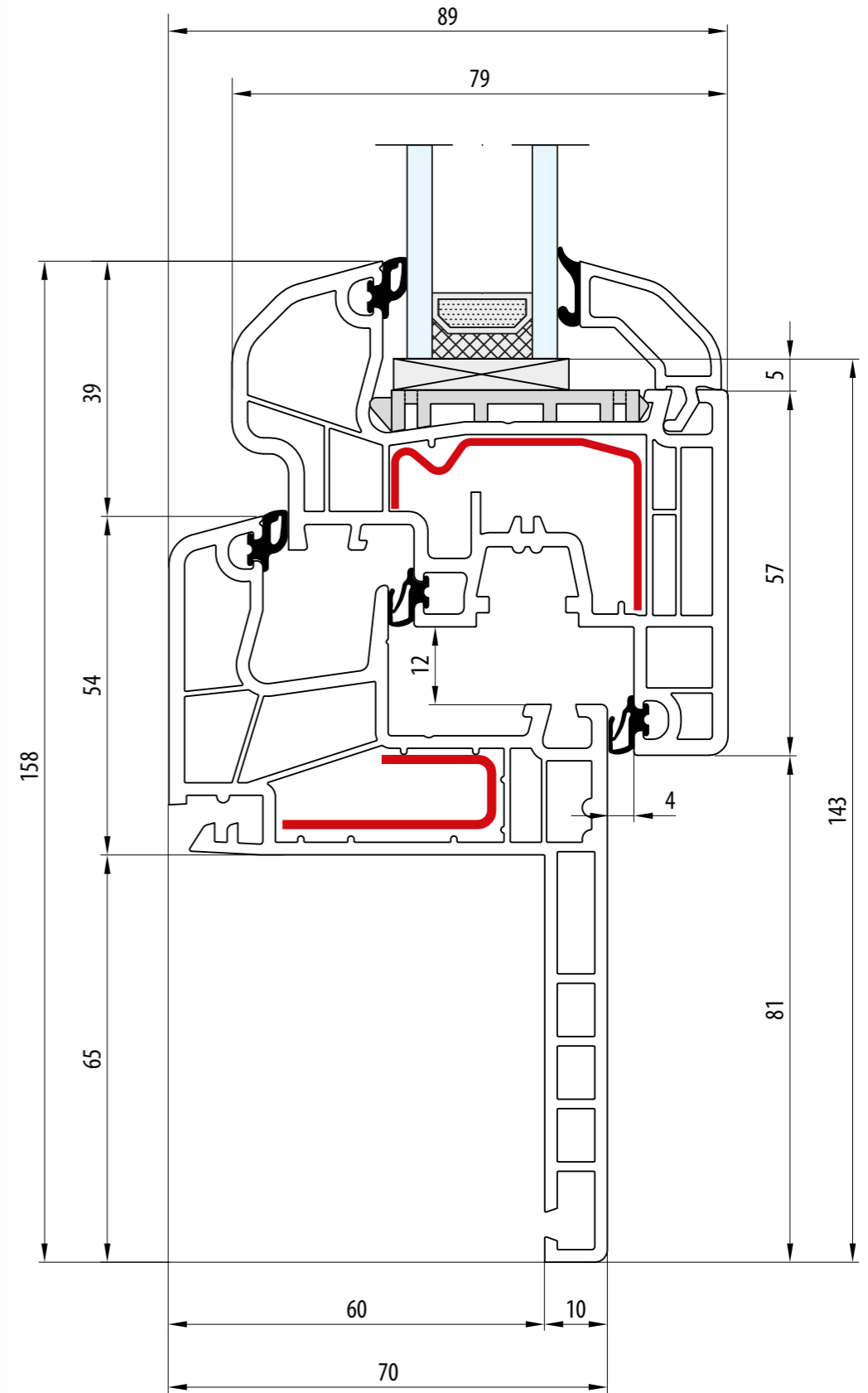

- RENOWACJA - Pletwa: 65 mm · Rama: 54 mm · Skrzydło: 77 mm
- RÉNOVATION - Lip: 65 mm · Dormant: 54 mm · Vantail: 77 mm
- RENOVATION - Strip: 65 mm · Frame: 54 mm · Sash: 77 mm
- RENOVIERUNG - Flosse: 65 mm · Rahmen: 54 mm · Flügel: 77 mm
- RINNOVAZIONE - Aletta da: 65 mm · Telaio: 54 mm · Anta: 77 mm

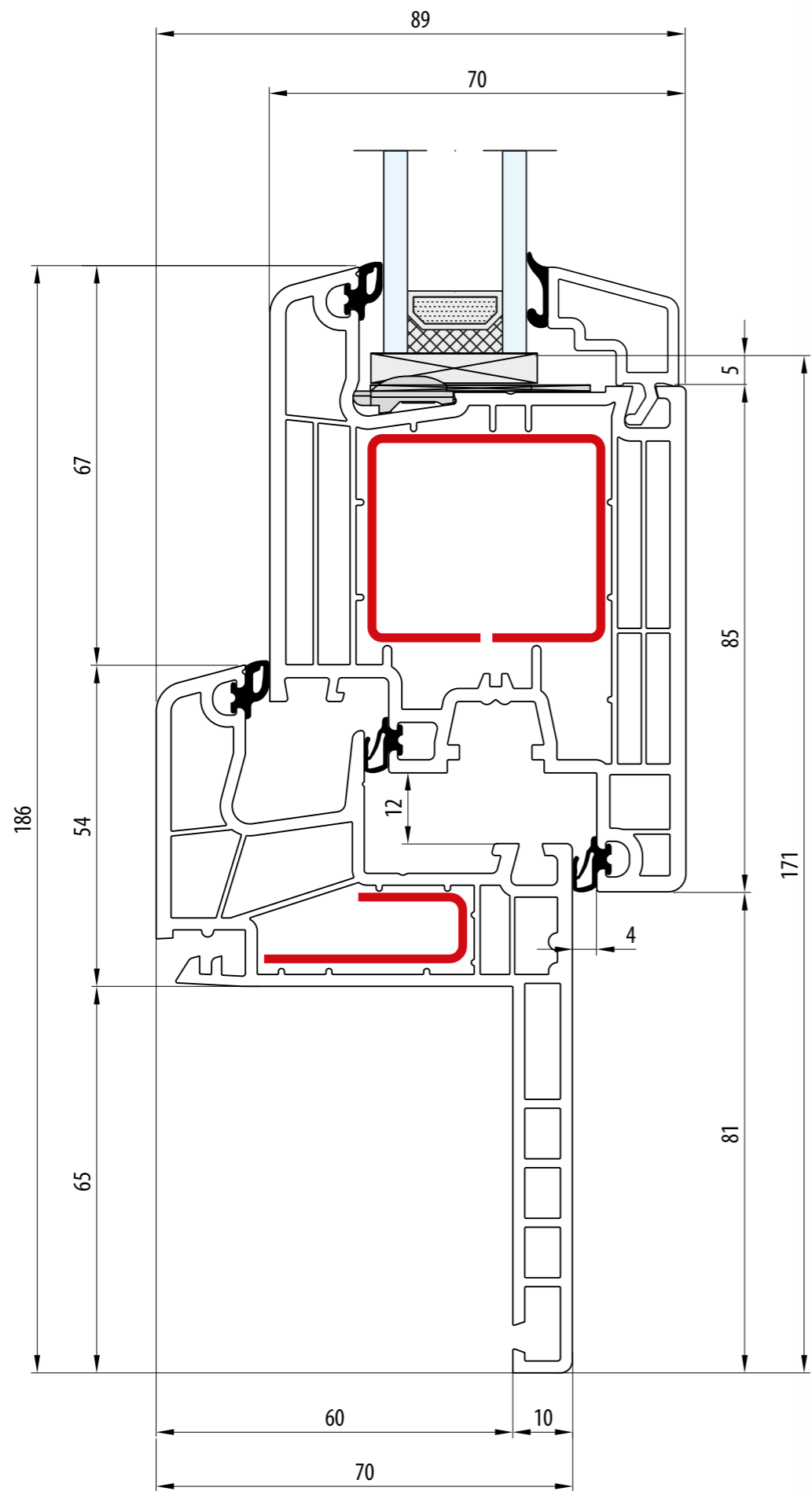

- RENOWACJA - Pletwa: 65 mm · Rama: 54 mm · Skrzydło: 105 mm
- RÉNOVATION - Lip: 65 mm · Dormant: 54 mm · Vantail: 105 mm
- RENOVATION - Strip: 65 mm · Frame: 54 mm · Sash: 105 mm
- RENOVIERUNG - Flosse: 65 mm · Rahmen: 54 mm · Flügel: 105 mm
- RINNOVAZIONE - Aletta da: 65 mm · Telaio: 54 mm · Anta: 105 mm

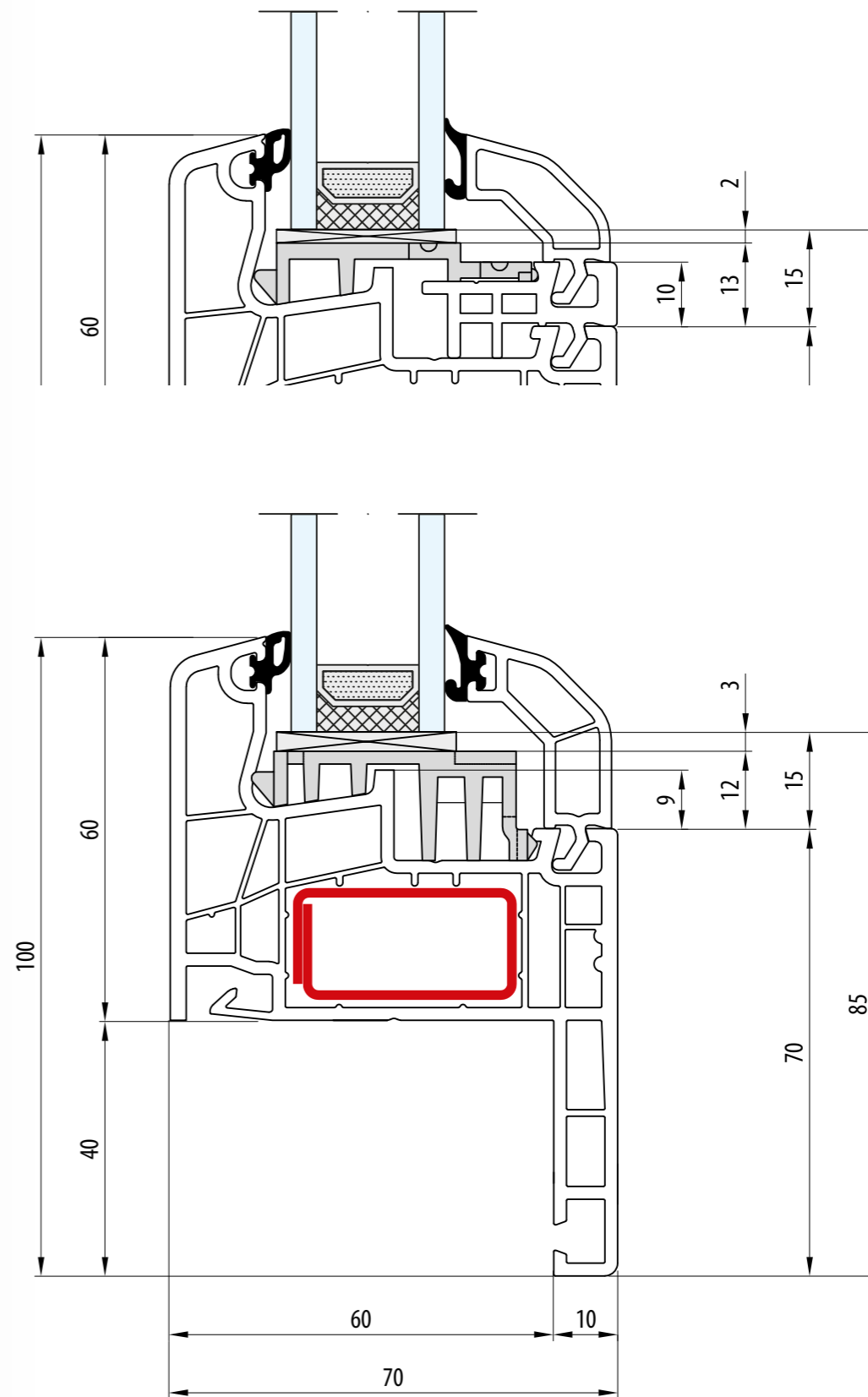
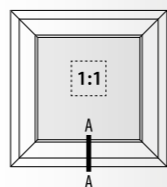

- RENOWACJA - Pletwa: 40 mm · Rama: 60 mm
- RÉNOVATION - Lip: 40 mm · Dormant: 60 mm
- RENOVATION - Strip: 40 mm · Frame: 60 mm
- RENOVIERUNG - Flosse: 40 mm · Rahmen: 60 mm
- RINNOVAZIONE - Aletta da: 40 mm · Telaio: 60 mm

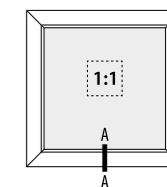

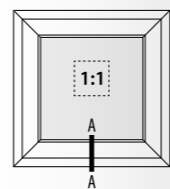
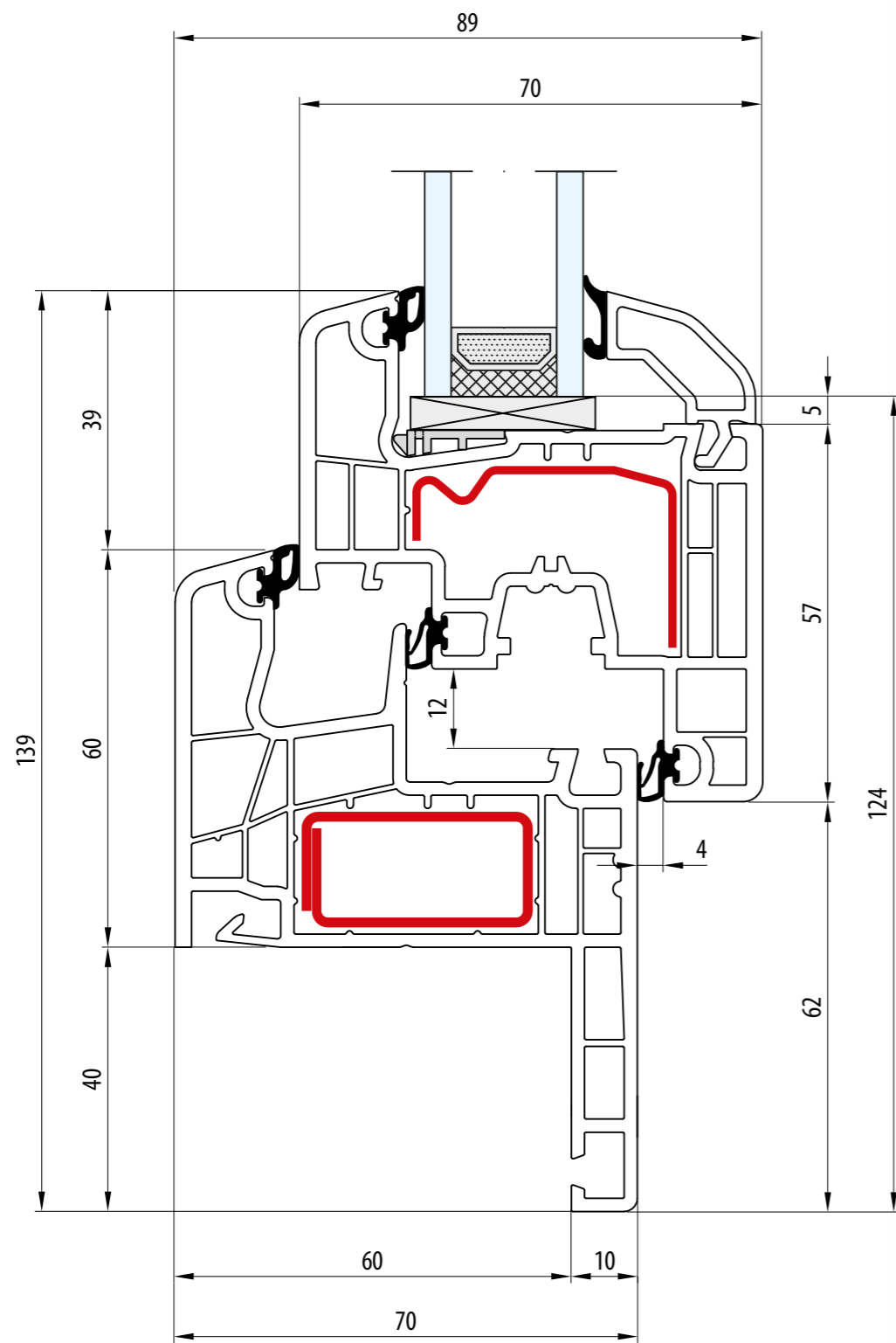

- RENOWACJA - Pletwa: 40 mm · Rama: 60 mm · Skrzydło: 77 mm
- RÉNOVATION - Lip: 40 mm · Dormant: 60 mm · Vantail: 77 mm
- RENOVATION - Strip: 40 mm · Frame: 60 mm · Sash: 77 mm
- RENOVIERUNG - Flosse: 40 mm · Rahmen: 60 mm · Flügel: 77 mm
- RINNOVAZIONE - Aletta da: 40 mm · Telaio: 60 mm · Anta: 77 mm

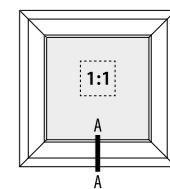
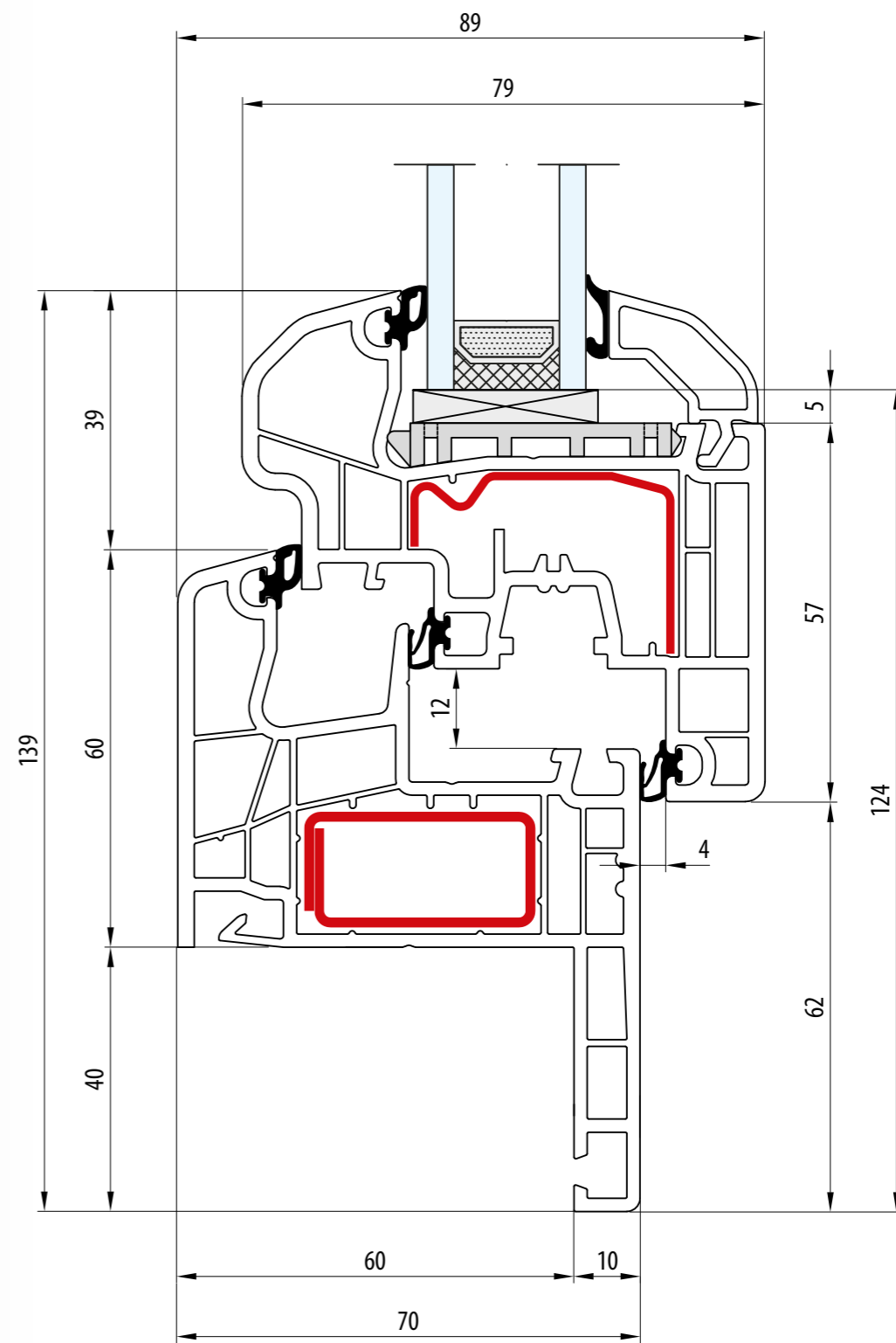

- RENOWACJA - Pletwa: 40 mm · Rama: 60 mm · Skrzydło: 77 mm
- RÉNOVATION - Lip: 40 mm · Dormant: 60 mm · Vantail: 77 mm
- RENOVATION - Strip: 40 mm · Frame: 60 mm · Sash: 77 mm
- RENOVIERUNG - Flosse: 40 mm · Rahmen: 60 mm · Flügel: 77 mm
- RINNOVAZIONE - Aletta da: 40 mm · Telaio: 60 mm · Anta: 77 mm

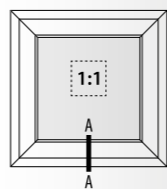
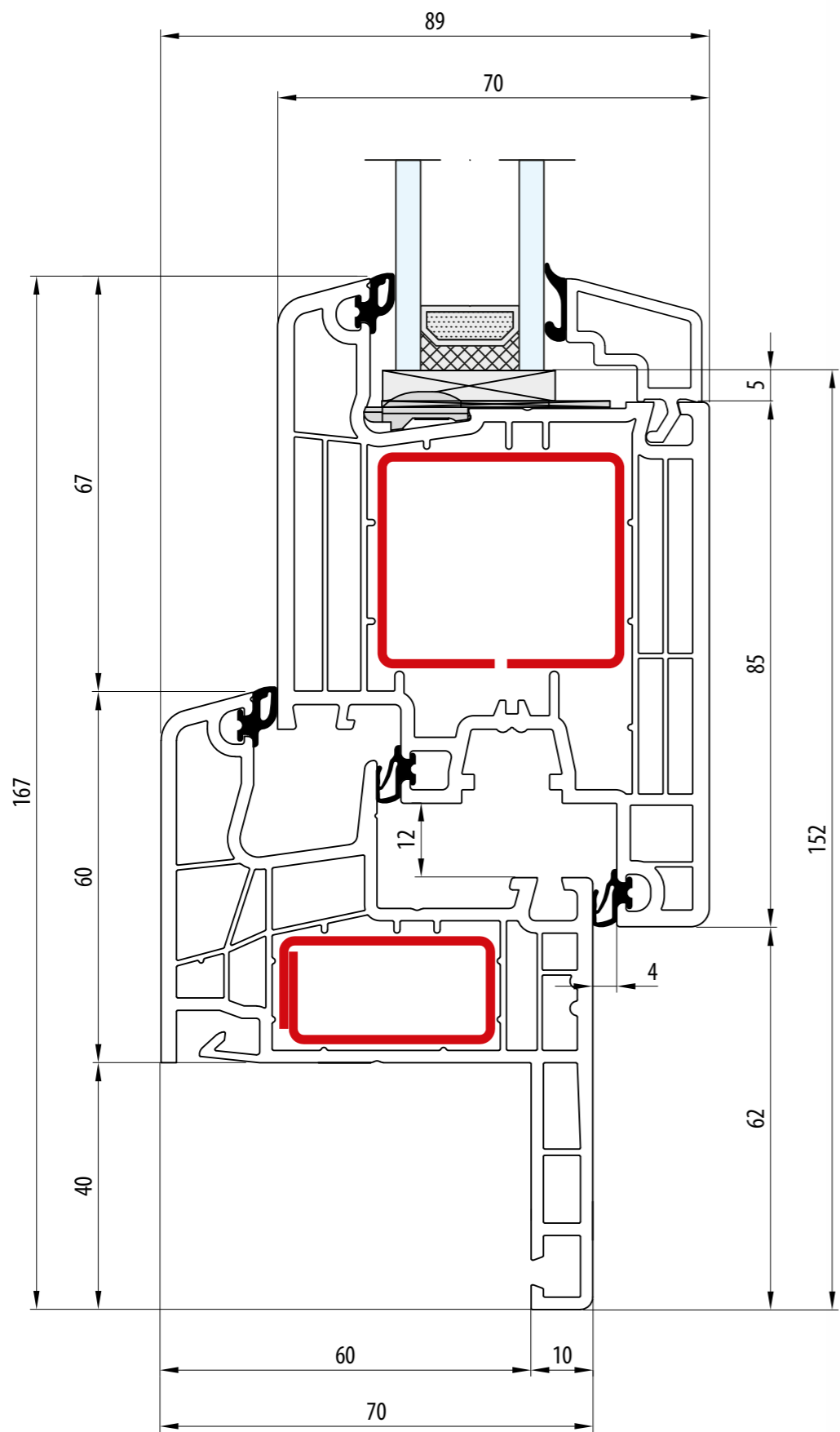

- RENOWACJA - Pletwa: 40 mm · Rama: 60 mm · Skrzydło: 105 mm
- RÉNOVATION - Lip: 40 mm · Dormant: 60 mm · Vantail: 105 mm
- RENOVATION - Strip: 40 mm · Frame: 60 mm · Sash: 105 mm
- RENOVIERUNG - Flosse: 40 mm · Rahmen: 60 mm · Flügel: 105 mm
- RINNOVAZIONE - Aletta da: 40 mm · Telaio: 60 mm · Anta: 105 mm

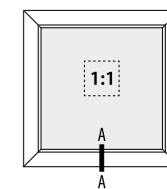
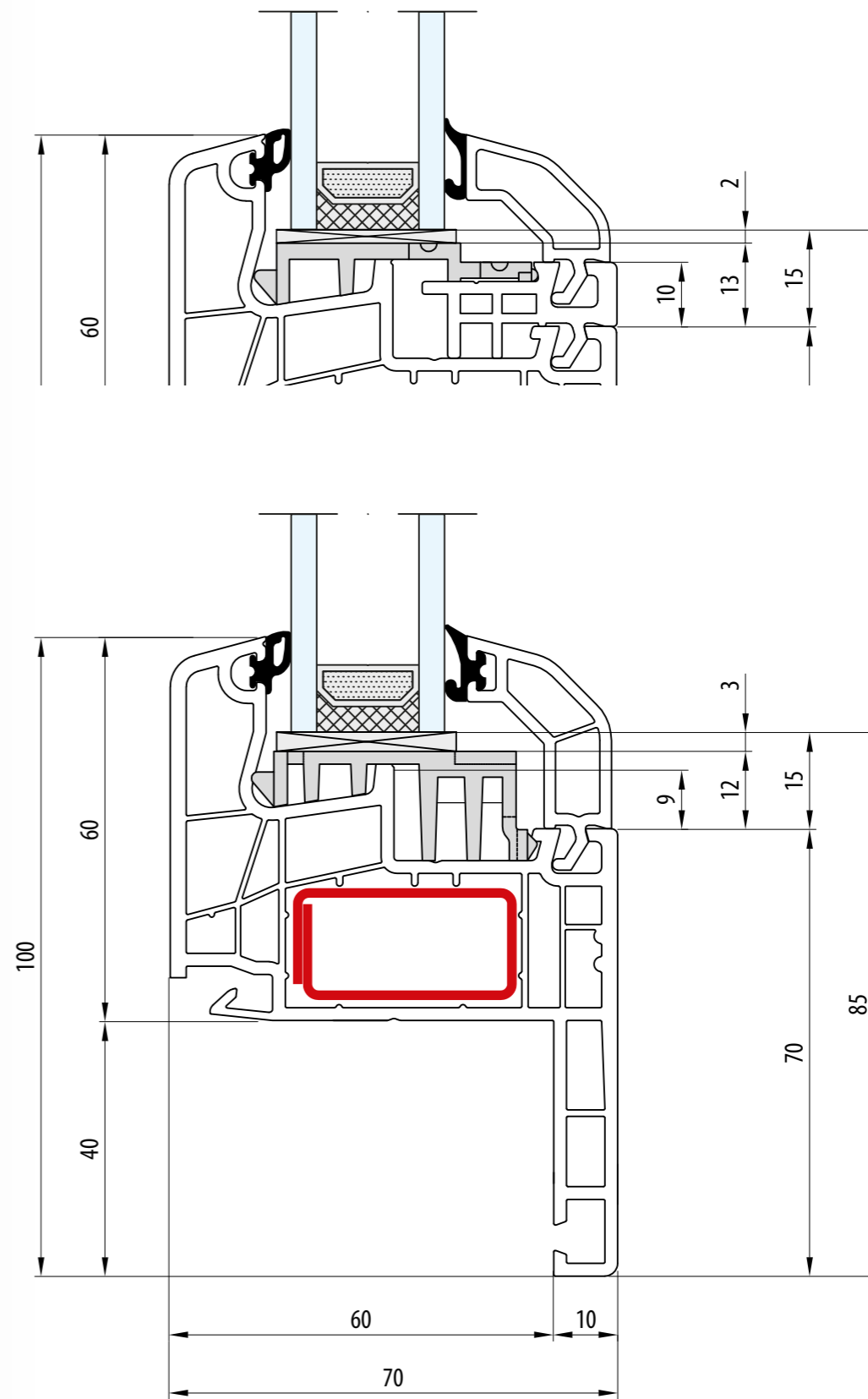

- RENOWACJA - Pletwa: 40 mm · Rama: 60 mm
- RÉNOVATION - Lip: 40 mm · Dormant: 60 mm
- RENOVATION - Strip: 40 mm · Frame: 60 mm
- RENOVIERUNG - Flosse: 40 mm · Rahmen: 60 mm
- RINNOVAZIONE - Aletta da: 40 mm · Telaio: 60 mm

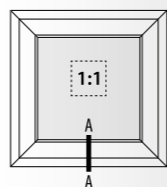
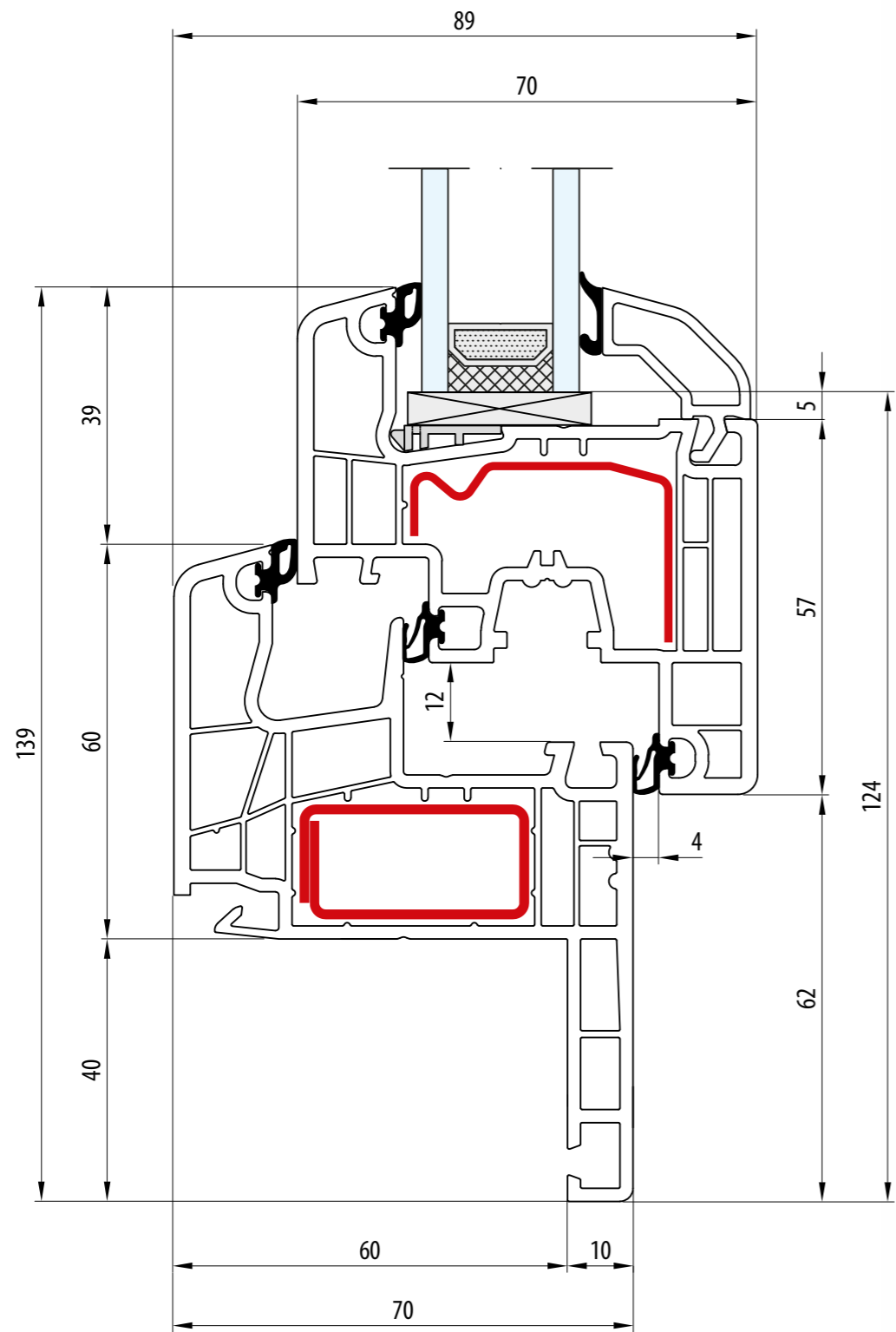

- RENOWACJA - Pletwa: 40 mm · Rama: 60 mm · Skrzydło: 77 mm
- RÉNOVATION - Lip: 40 mm · Dormant: 60 mm · Vantail: 77 mm
- RENOVATION - Strip: 40 mm · Frame: 60 mm · Sash: 77 mm
- RENOVIERUNG - Flosse: 40 mm · Rahmen: 60 mm · Flügel: 77 mm
- RINNOVAZIONE - Aletta da: 40 mm · Telaio: 60 mm · Anta: 77 mm

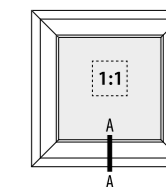
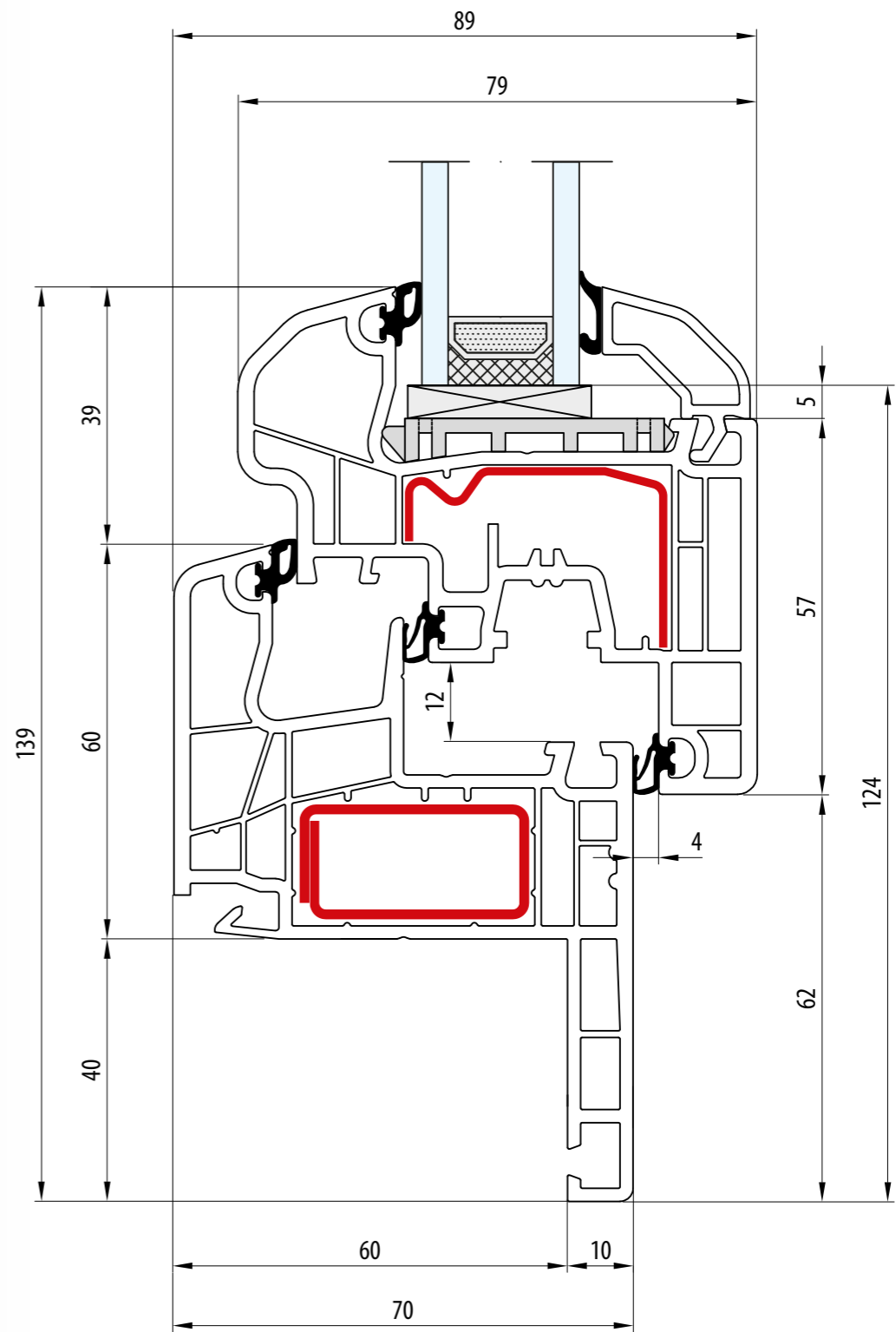

- RENOWACJA - Pletwa: 40 mm · Rama: 60 mm · Skrzydło: 77 mm
- RÉNOVATION - Lip: 40 mm · Dormant: 60 mm · Vantail: 77 mm
- RENOVATION - Strip: 40 mm · Frame: 60 mm · Sash: 77 mm
- RENOVIERUNG - Flosse: 40 mm · Rahmen: 60 mm · Flügel: 77 mm
- RINNOVAZIONE - Aletta da: 40 mm · Telaio: 60 mm · Anta: 77 mm

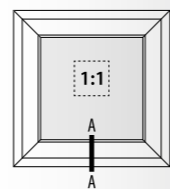
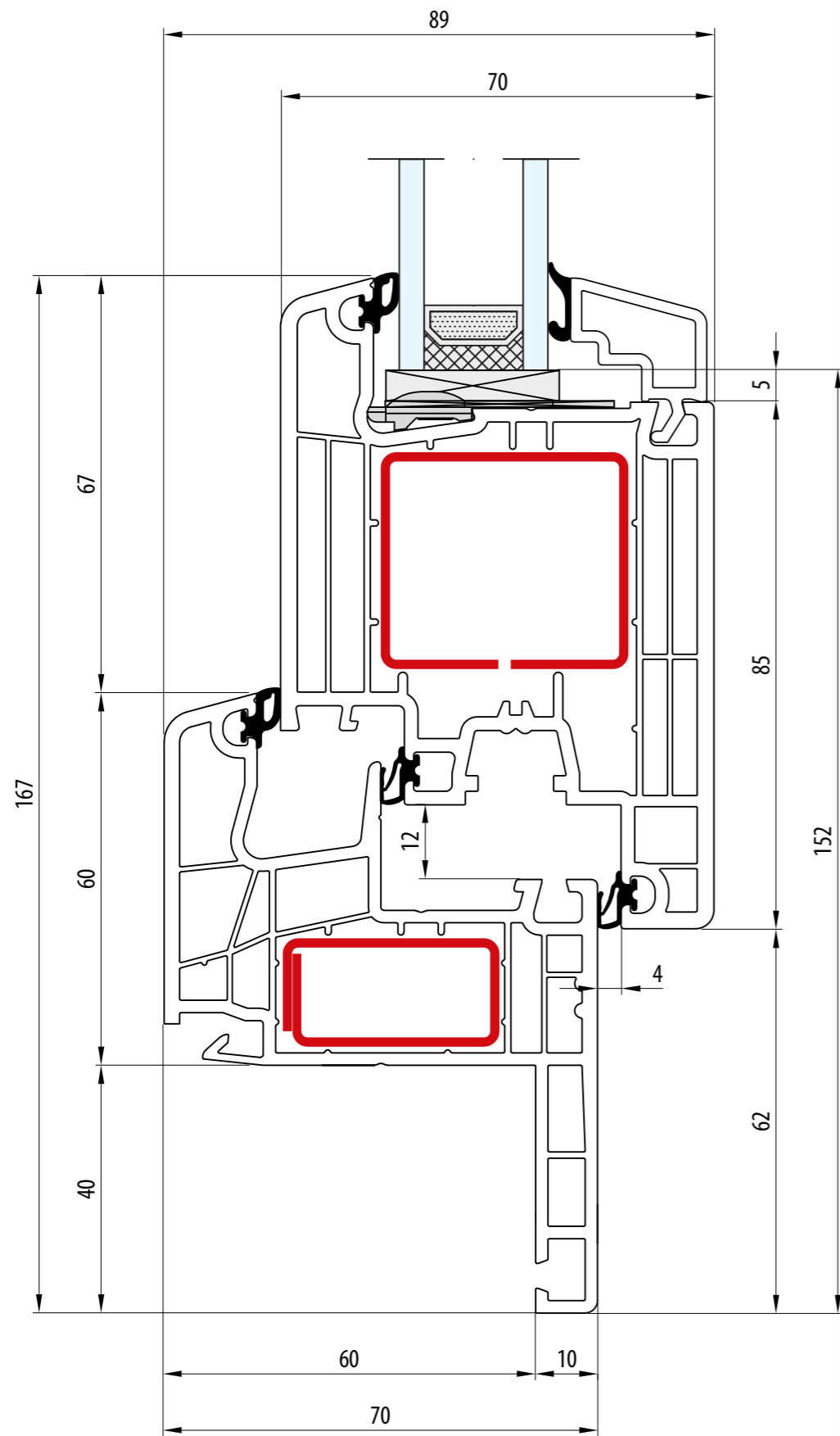

- RENOWACJA - Pletwa: 40 mm · Rama: 60 mm · Skrzydło: 105 mm
- RÉNOVATION - Lip: 40 mm · Dormant: 60 mm · Vantail: 105 mm
- RENOVATION - Strip: 40 mm · Frame: 60 mm · Sash: 105 mm
- RENOVIERUNG - Flosse: 40 mm · Rahmen: 60 mm · Flügel: 105 mm
- RINNOVAZIONE - Aletta da: 40 mm · Telaio: 60 mm · Anta: 105 mm

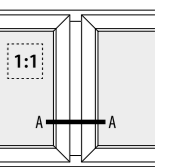
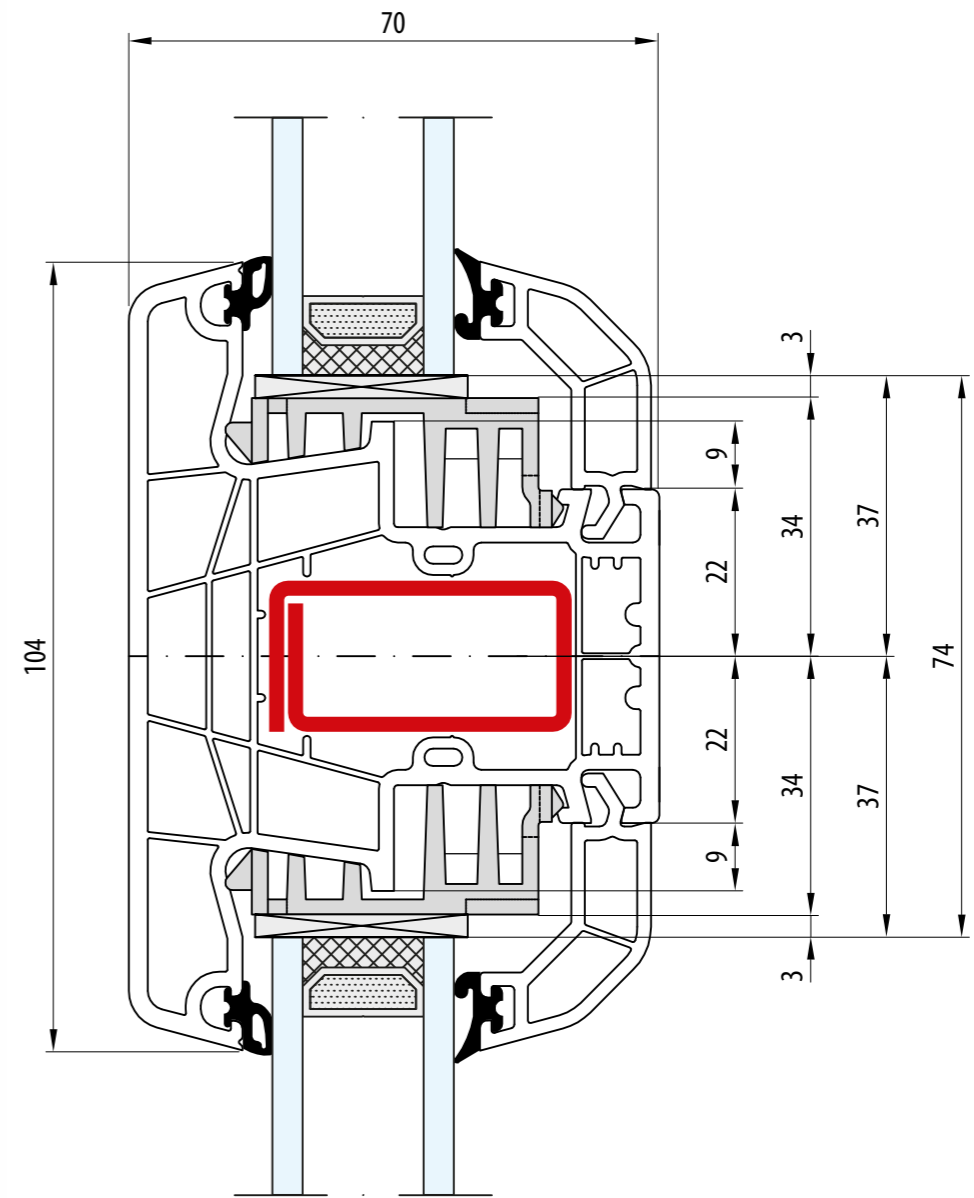

- Słupek staly: 104 mm
- Meneau fixe: 104 mm
- Fix post: 104 mm
- Festem Pfahl: 104 mm
- Montante fisso: 104 mm

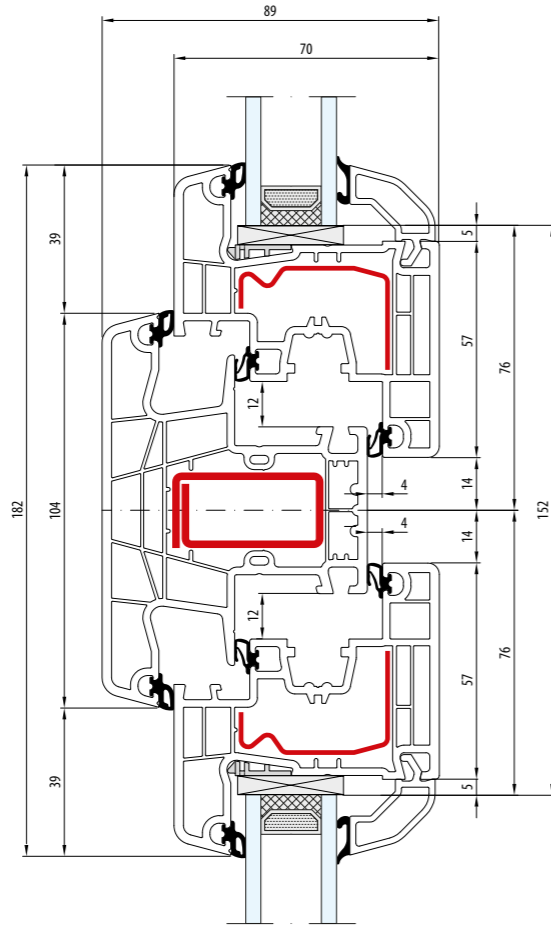

- Słupek stały: 104 mm · Skrzydło: 77 mm
- Meneau fixe: 104 mm · Vantail: 77 mm
- Fix post: 104 mm · Sash: 77 mm
- Festem Pfahl: 104 mm · Flügel: 77 mm
- Montante fisso: 104 mm · Anta: 77 mm

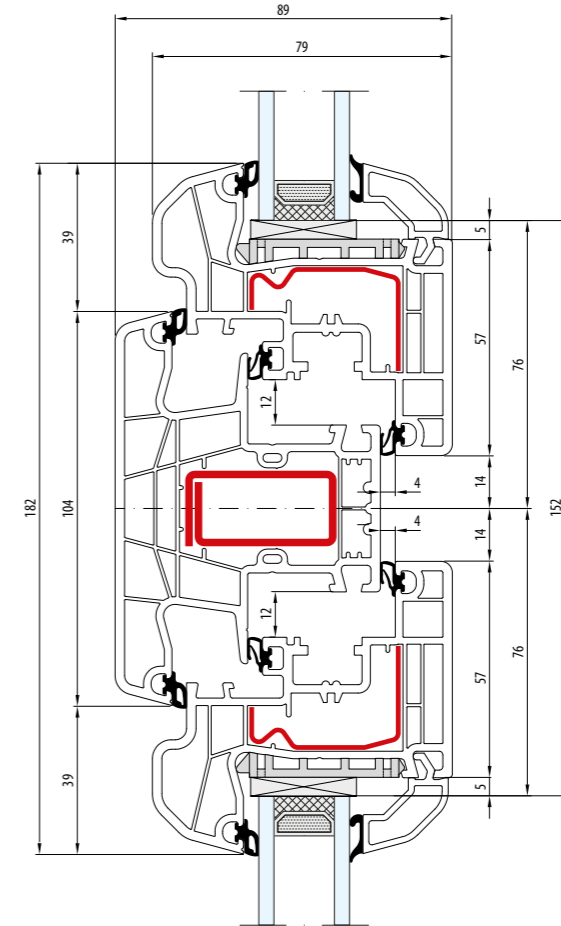
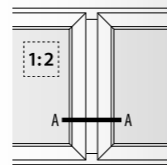

- Słupek stały: 104 mm · Skrzydło: 77 mm
- Meneau fixe: 104 mm · Vantail: 77 mm
- Fix post: 104 mm · Sash: 77 mm
- Festem Pfahl: 104 mm · Flügel: 77 mm
- Montante fisso: 104 mm · Anta: 77 mm

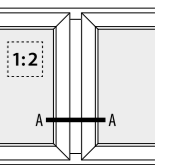

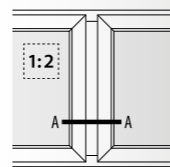
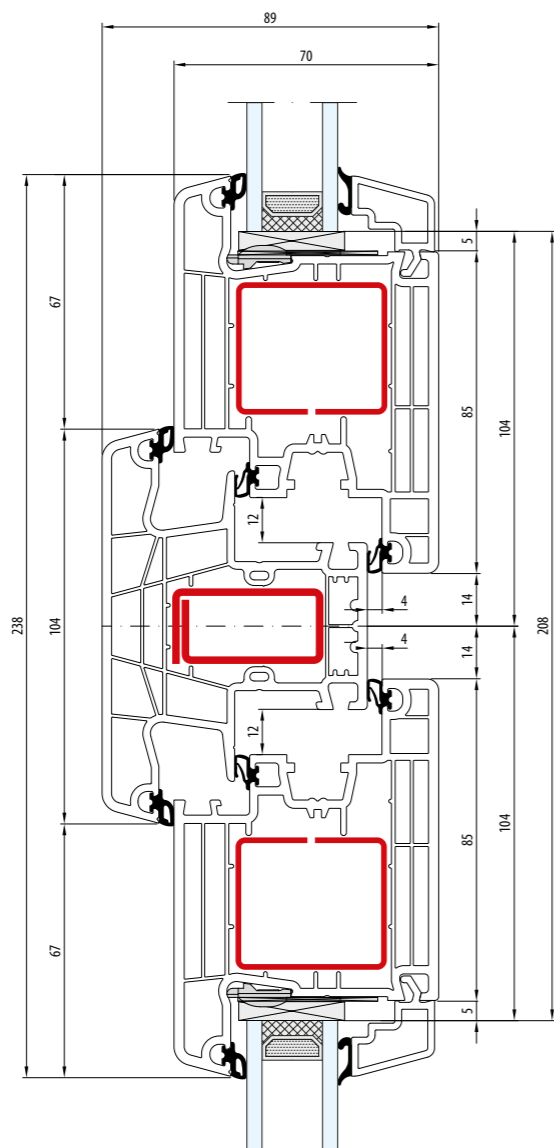

- Słupek stały: 104 mm · Skrzydło: 105 mm
- Meneau fixe: 104 mm · Vantail: 105 mm
- Fix post: 104 mm · Sash: 105 mm
- Festem Pfahl: 104 mm · Flügel: 105 mm
- Montante fisso: 104 mm · Anta: 105 mm

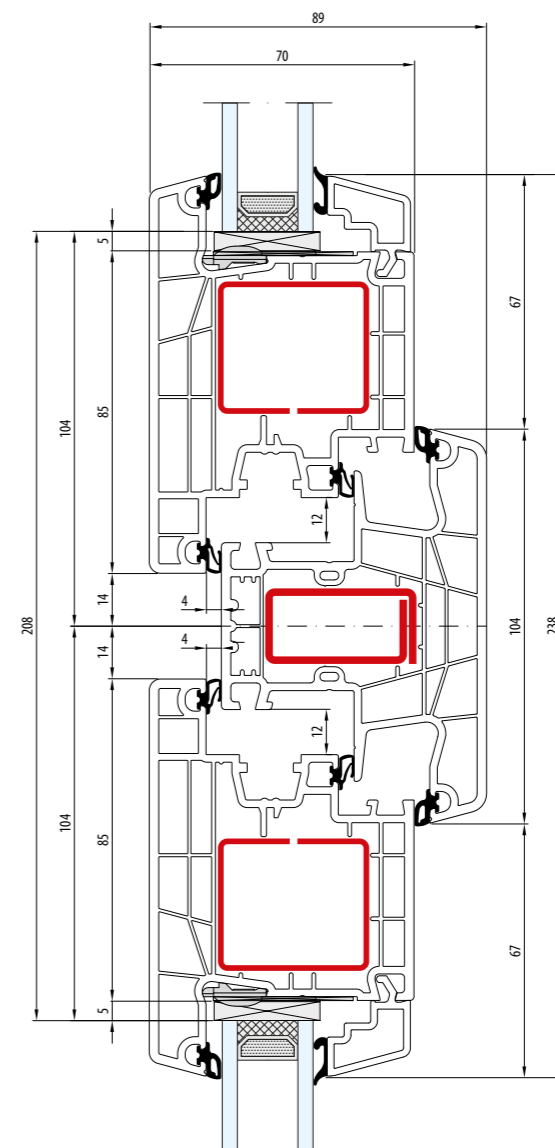
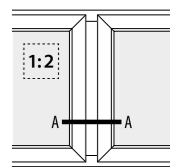

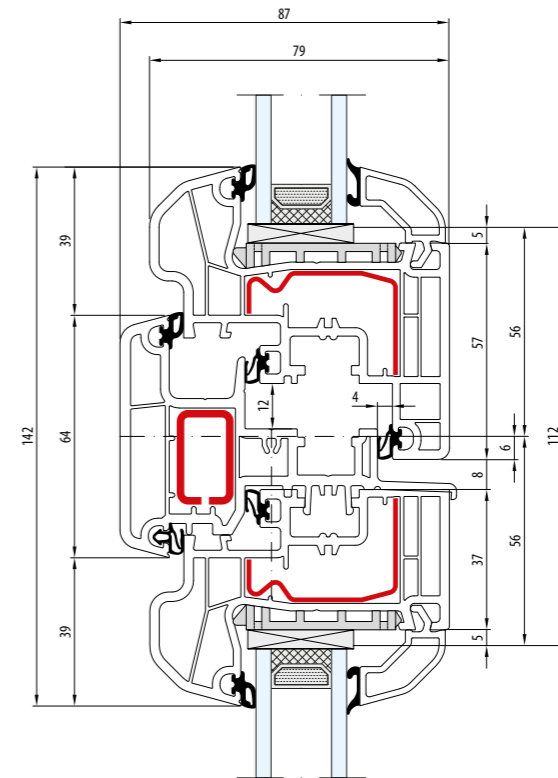
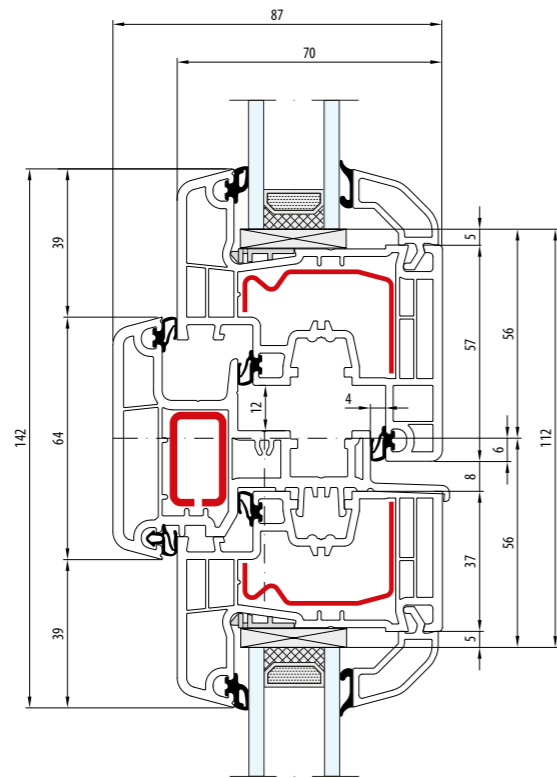

- Słupek ruchomy: 64 mm · Skrzydło: 77 mm / 57 mm
- Meneau mobile: 64 mm · Vantail: 77 mm / 57 mm
- Movable post: 64 mm · Sash: 77 mm / 57 mm
- Stulp: 64 mm · Flügel: 77 mm / 57 mm
- Montante mobile: 64 mm · Anta: 77 mm / 57 mm

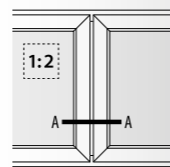

- Słupek ruchomy: 64 mm · Skrzydło: 77 mm / 57 mm
- Meneau mobile: 64 mm · Vantail: 77 mm / 57 mm
- Movable post: 64 mm · Sash: 77 mm / 57 mm
- Stulp: 64 mm · Flügel: 77 mm / 57 mm
- Montante mobile: 64 mm · Anta: 77 mm / 57 mm

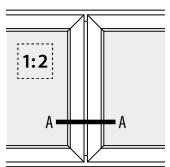

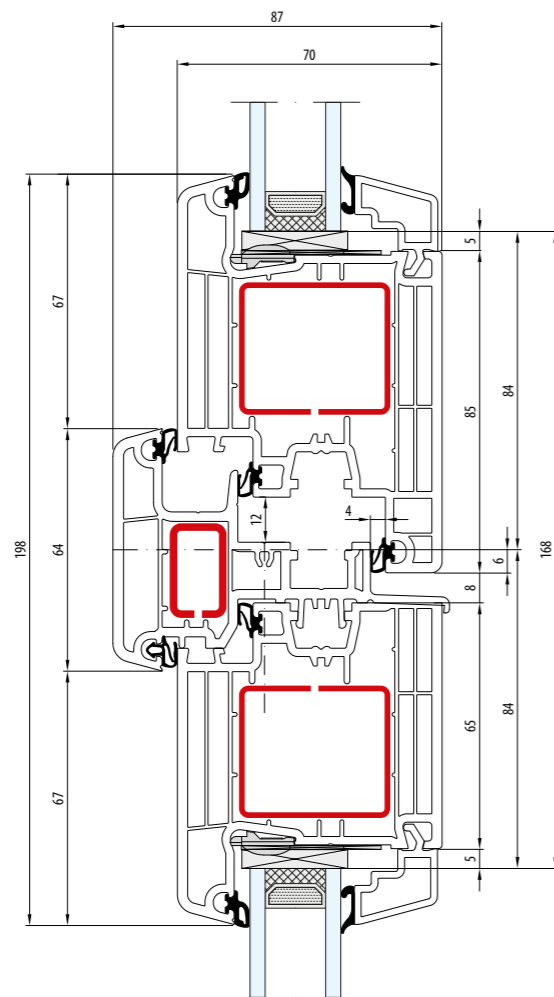

- Słupek ruchomy: 64 mm · Skrzydło: 105 mm / 85 mm
- Meneau mobile: 64 mm · Vantail: 105 mm / 85 mm
- Movable post: 64 mm · Sash: 105 mm / 85 mm
- Stulp: 64 mm · Flügel: 105 mm / 85 mm
- Montante mobile: 64 mm · Anta: 105 mm / 85 mm

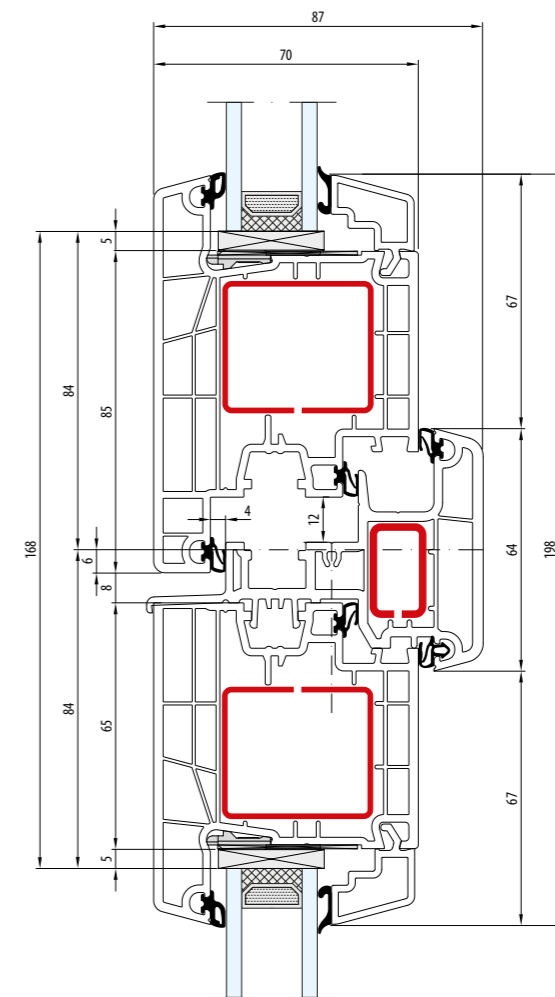
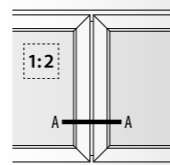

- Słupek ruchomy: 64 mm · Skrzydło: 105 mm / 85 mm
- Meneau mobile: 64 mm · Vantail: 105 mm / 85 mm
- Movable post: 64 mm · Sash: 105 mm / 85 mm
- Stulp: 64 mm · Flügel: 105 mm / 85 mm
- Montante mobile: 64 mm · Anta: 105 mm / 85 mm

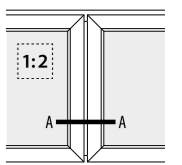

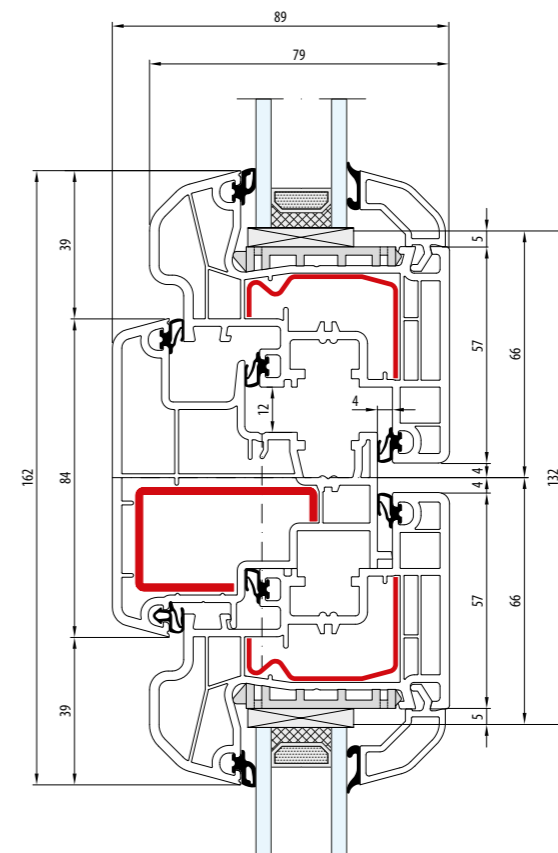
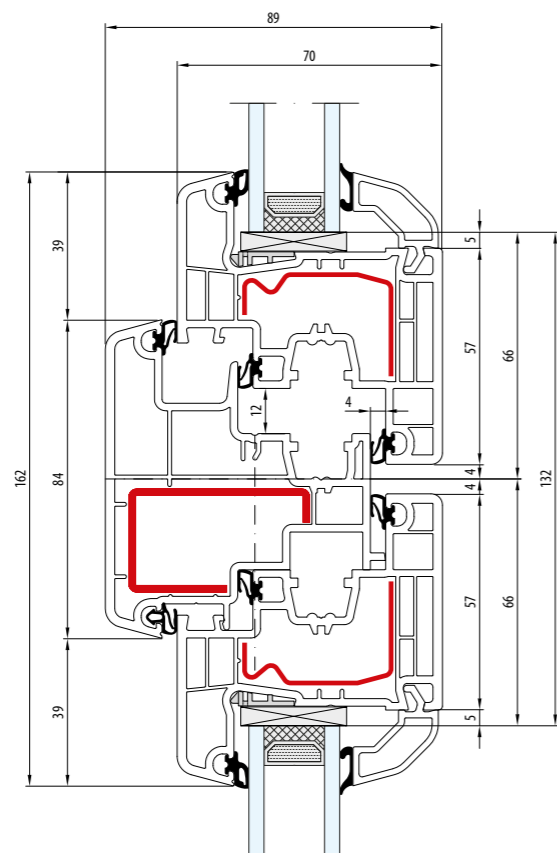



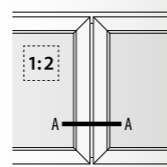

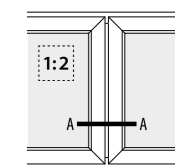

- Słupek ruchomy: 84 mm · Skrzydło: 77 mm
- Meneau mobile: 84 mm · Vantail: 77 mm
- Movable post: 84 mm · Sash: 77 mm
- Stulp: 84 mm · Flügel: 77 mm
- Montante mobile: 84 mm · Anta: 77 mm

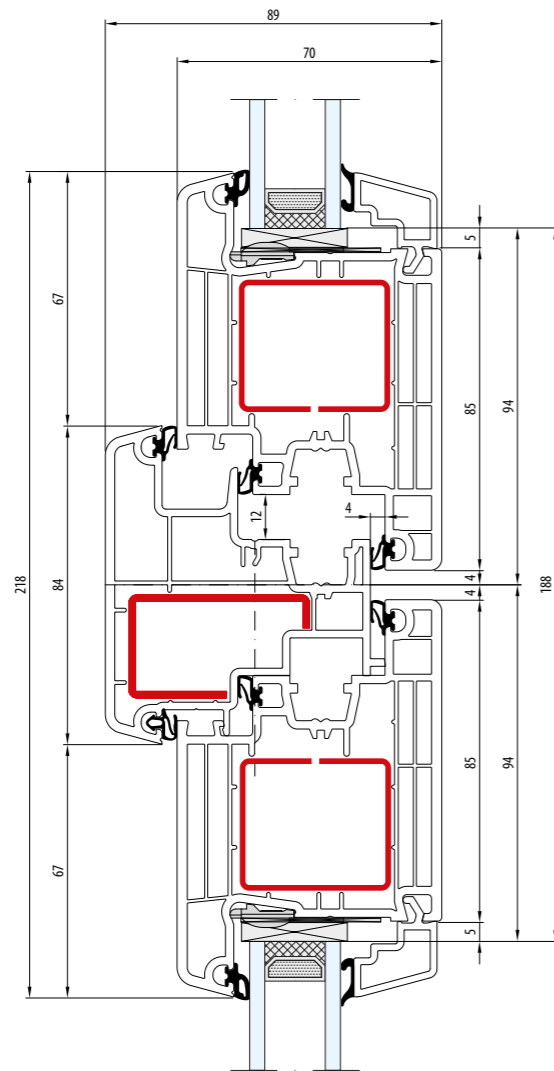







- Słupek ruchomy: 84 mm · Skrzydło: 77 mm
- Meneau mobile: 84 mm · Vantail: 77 mm
- Movable post: 84 mm · Sash: 77 mm
- Stulp: 84 mm · Flügel: 77 mm
- Montante mobile: 84 mm · Anta: 77 mm

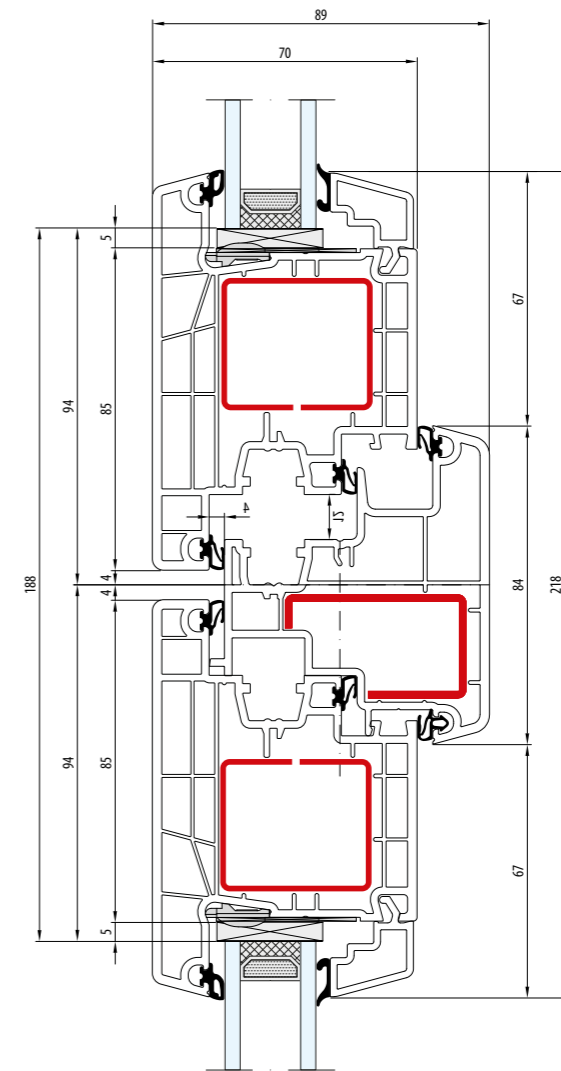
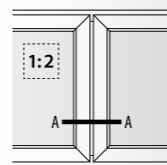



-  Słupek ruchomy: 84 mm · Skrzydło: 105 mm
-  Meneau mobile: 84 mm · Vantail: 105 mm
-  Movable post: 84 mm · Sash: 105 mm
-  Stulp: 84 mm · Flügel: 105 mm
-  Montante mobile: 84 mm · Anta: 105 mm



-  Słupek ruchomy: 84 mm · Skrzydło: 105 mm
-  Meneau mobile: 84 mm · Vantail: 105 mm
-  Movable post: 84 mm · Sash: 105 mm
-  Stulp: 84 mm · Flügel: 105 mm
-  Montante mobile: 84 mm · Anta: 105 mm

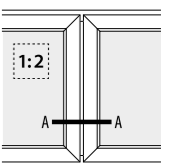

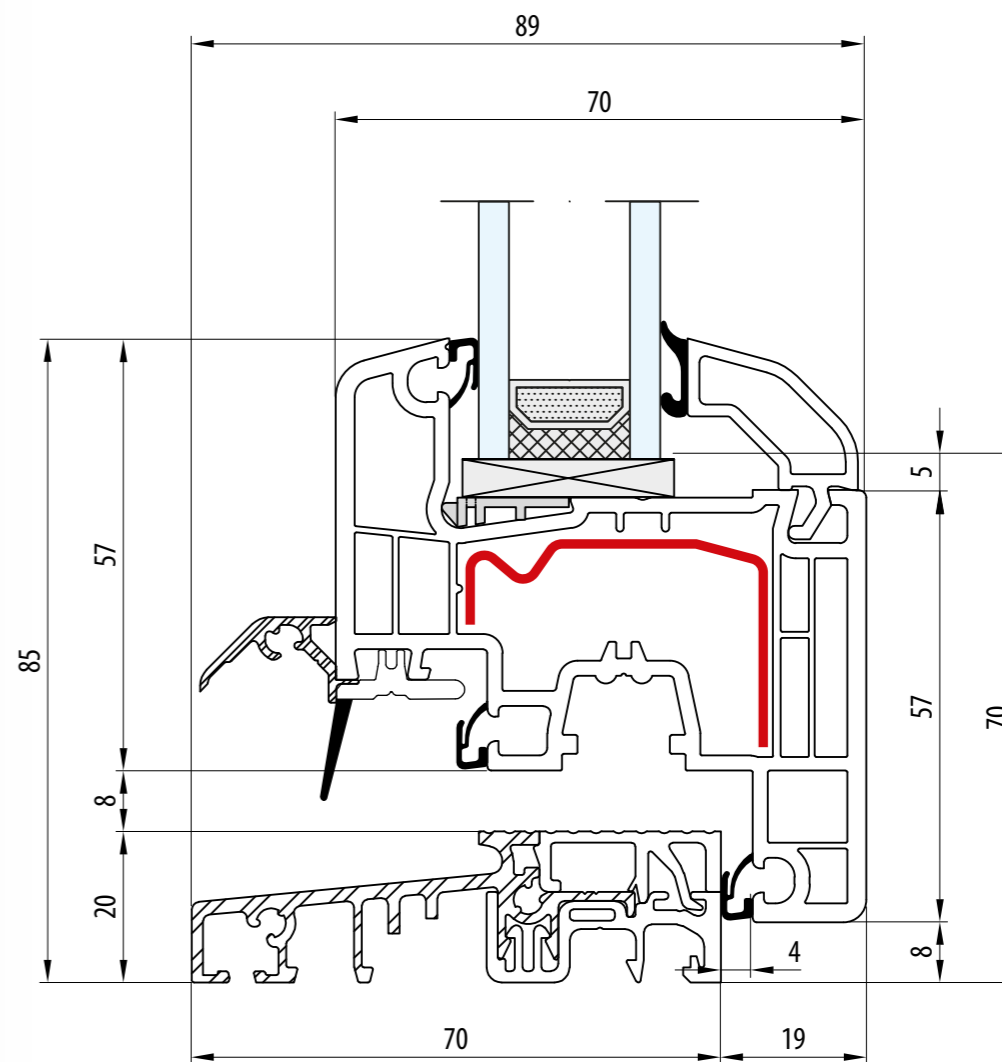
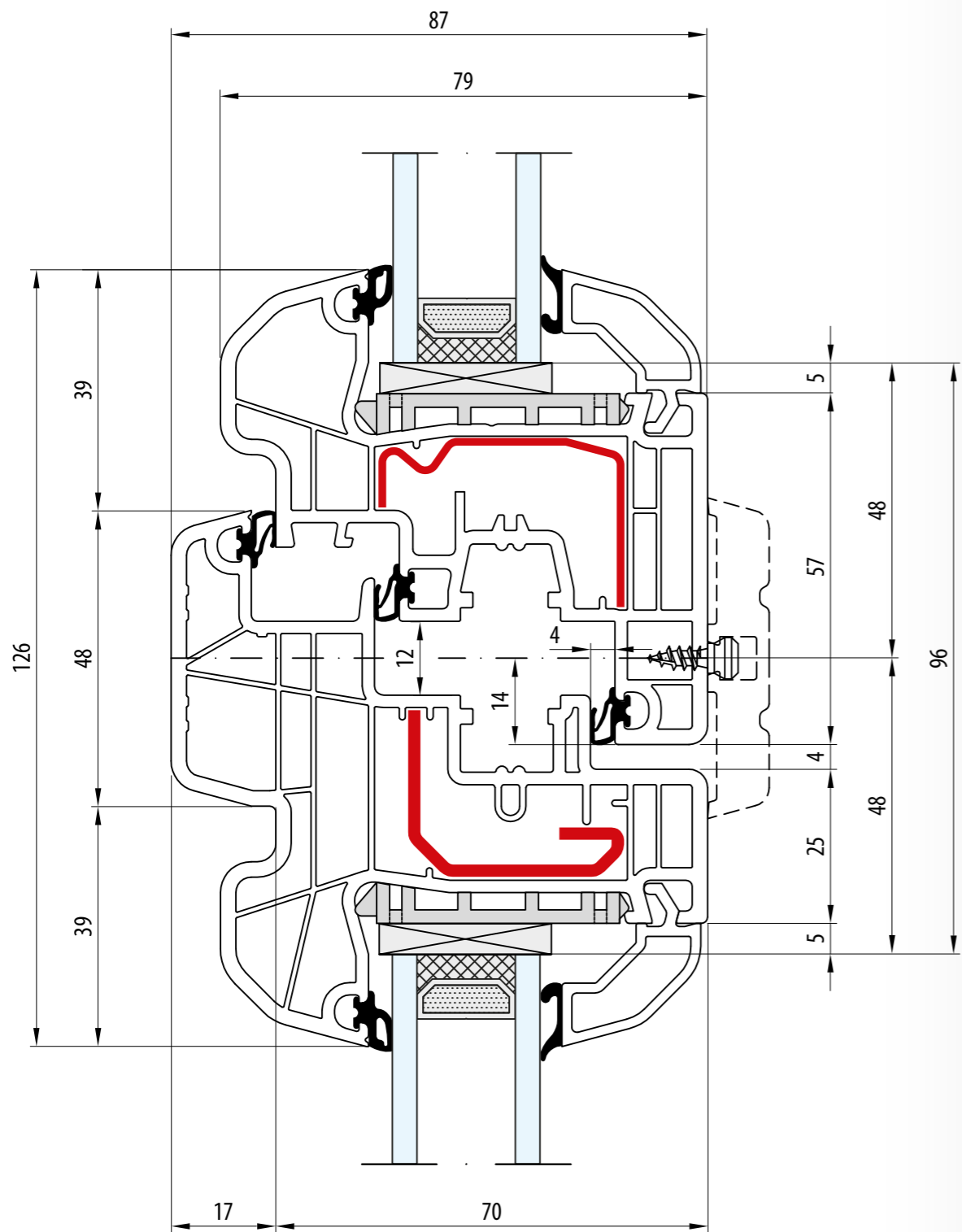

- Klamka centralna · Skrzydło: 77 mm
- Battue centrée · Vantail: 77 mm
- Central handle · Sash: 77 mm
- Zentrale Olive · Flügel: 77 mm
- Maniglia centrale · Anta: 77 mm

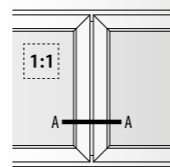

- Próg: 20 mm · Skrzydło: 77 mm
- Seuil: 20 mm · Vantail: 77 mm
- Threshold: 20 mm · Sash: 77 mm
- Schwelle: 20 mm · Flügel: 77 mm
- Soglia: 20 mm · Anta: 77 mm

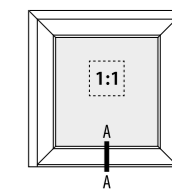

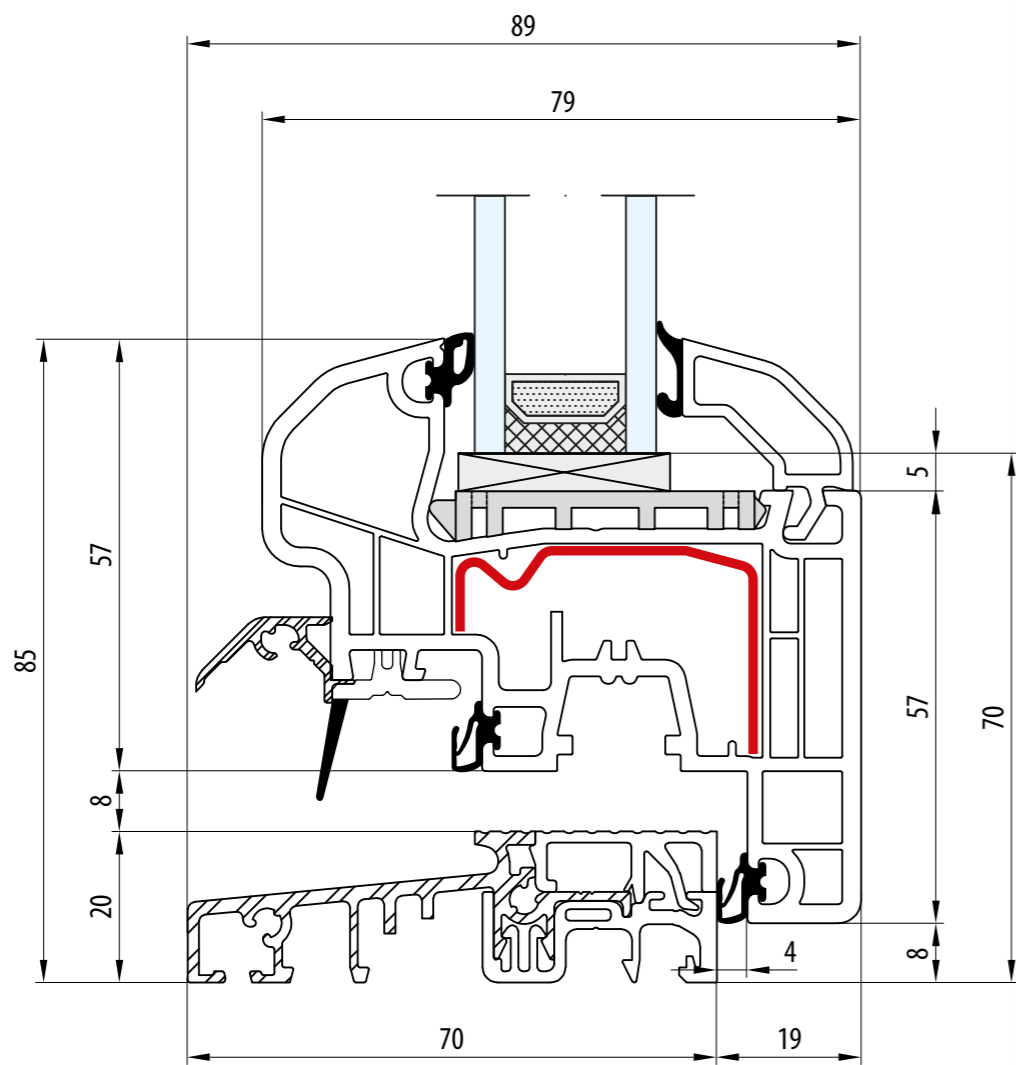

- Próg: 20 mm · Skrzydło: 77 mm
- Seuil: 20 mm · Vantail: 77 mm
- Threshold: 20 mm · Sash: 77 mm
- Schwelle: 20 mm · Flügel: 77 mm
- Soglia: 20 mm · Anta: 77 mm

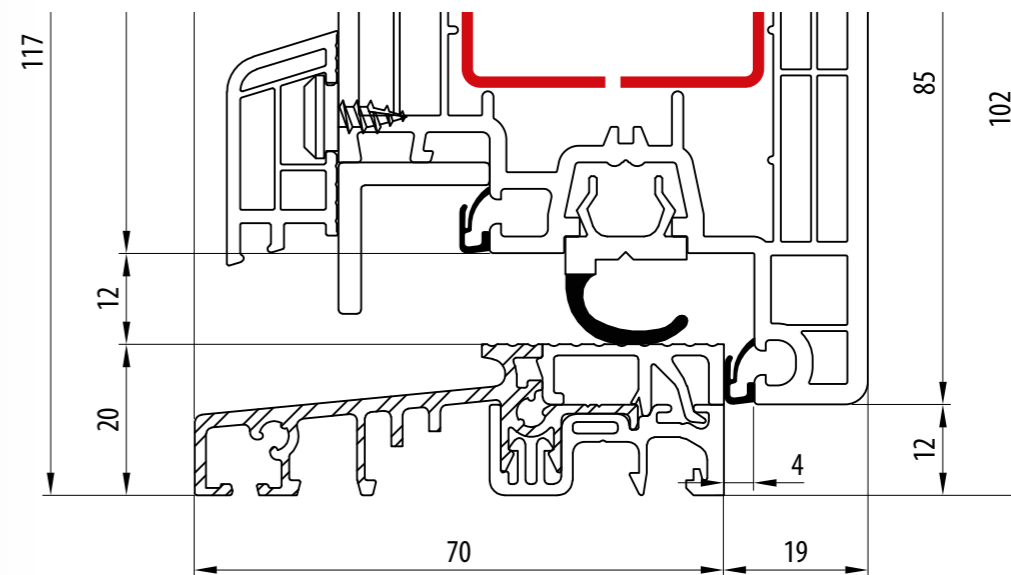
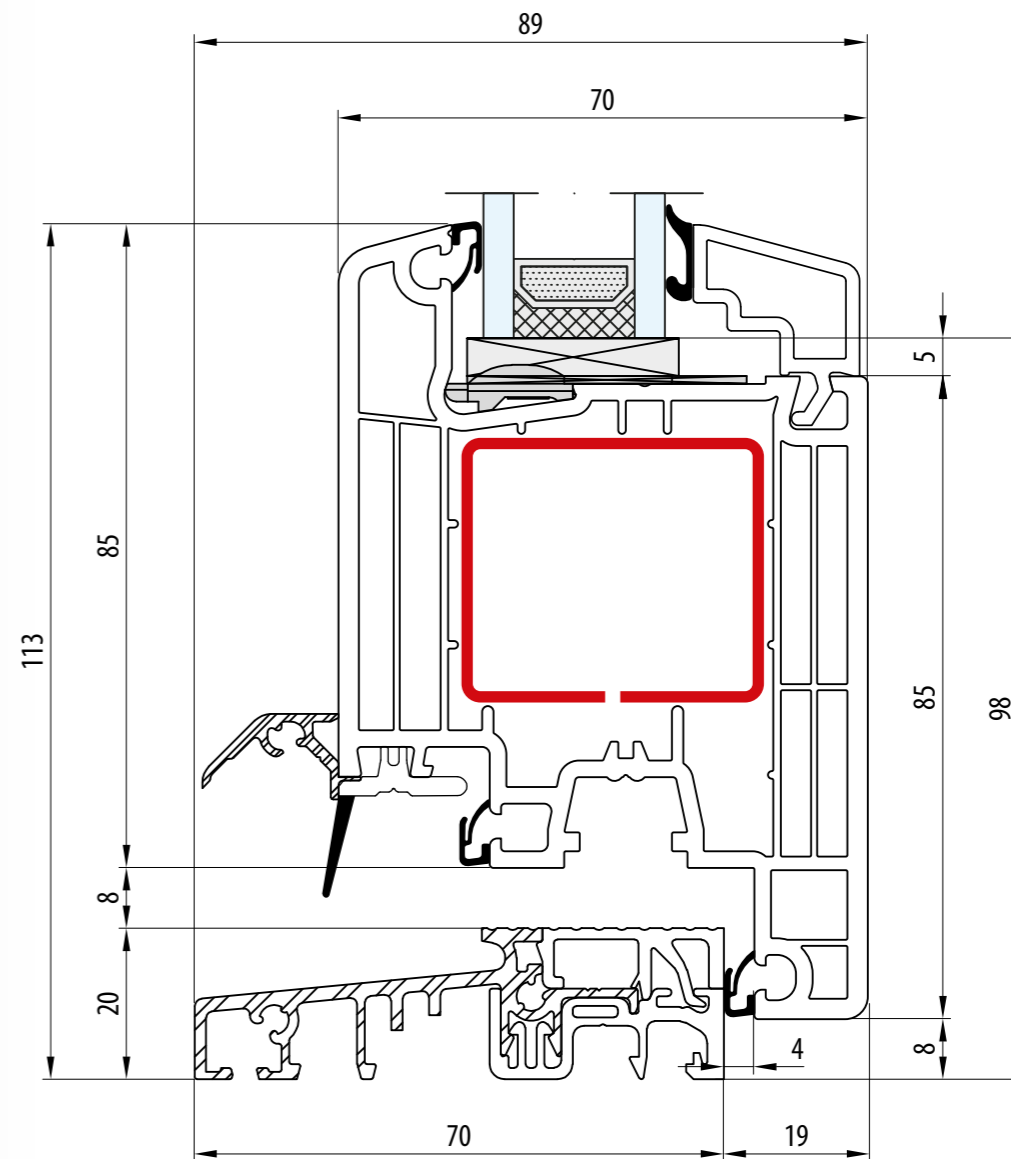
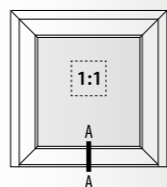

- Próg: 20 mm · Skrzydło: 105 mm
- Seuil: 20 mm · Vantail: 105 mm
- Threshold: 20 mm · Sash: 105 mm
- Schwelle: 20 mm · Flügel: 105 mm
- Soglia: 20 mm · Anta: 105 mm

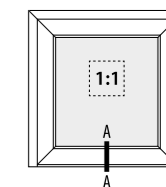

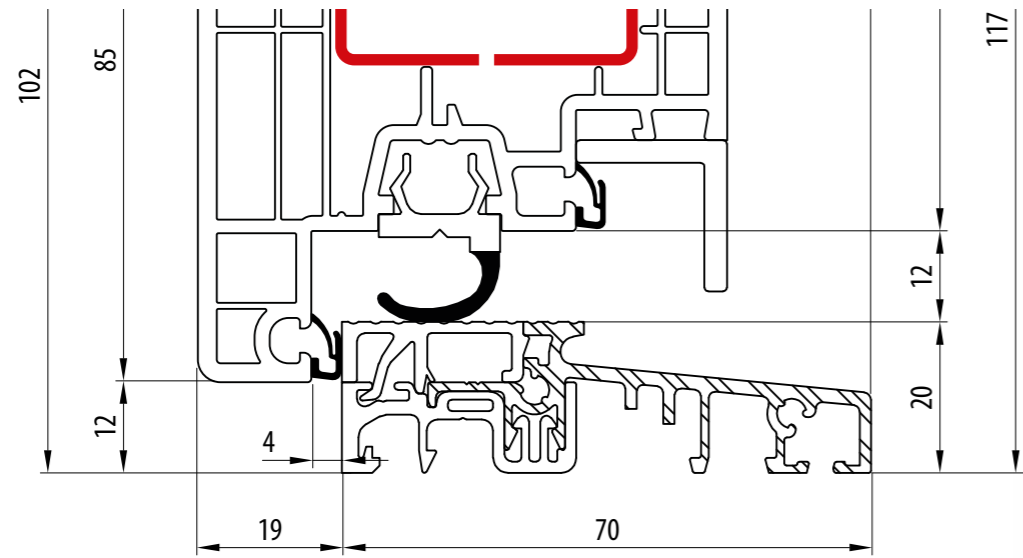
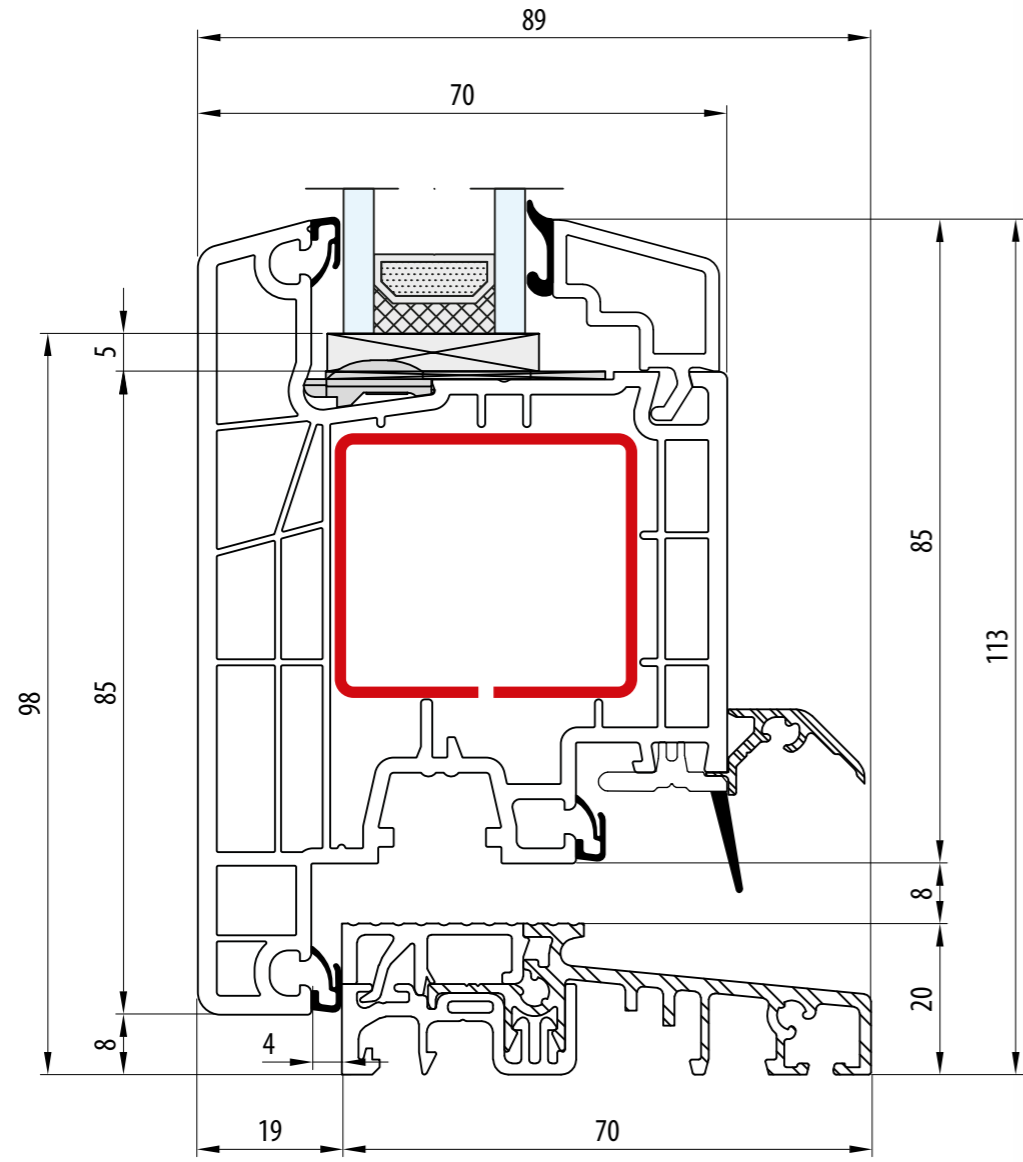

- Próg: 20 mm · Skrzydło: 105 mm
- Seuil: 20 mm · Vantail: 105 mm
- Threshold: 20 mm · Sash: 105 mm
- Schwelle: 20 mm · Flügel: 105 mm
- Soglia: 20 mm · Anta: 105 mm

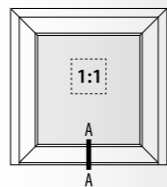

IDEAL 7000 NEW

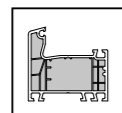
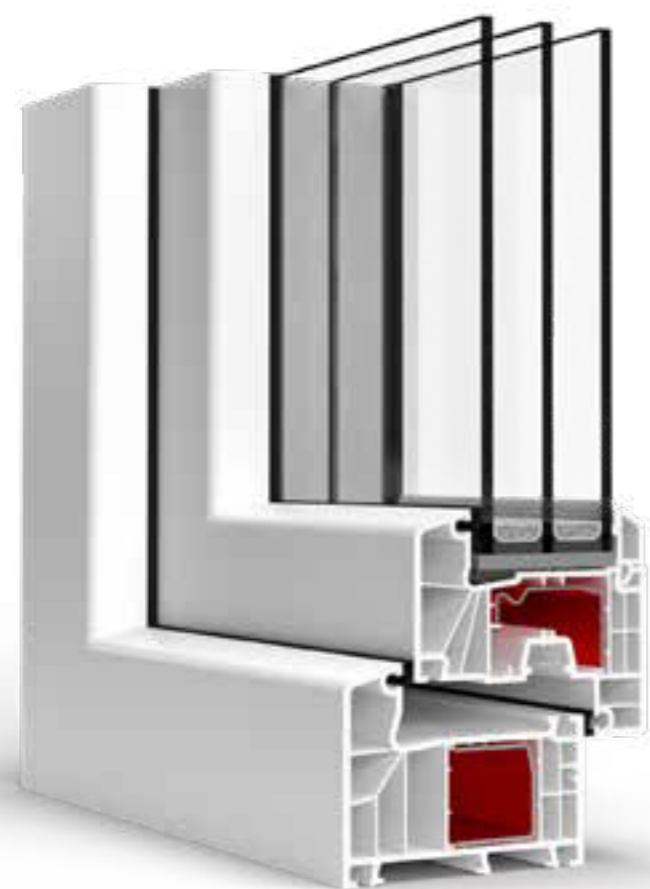

6



2

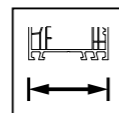

85

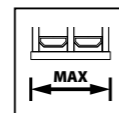

52

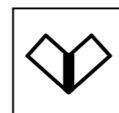

V-SUPER SOLUTION



V-PERFECT TECHNOLOGY

IDEAL 4000

IDEAL 6000 NEW

IDEAL 5000

IDEAL 7000 NEW

IDEAL 8000

ENERGETO 8000

IDEAL 4000

IDEAL 6000 NEW

IDEAL 5000

IDEAL 7000 NEW

IDEAL 8000

ENERGETO 8000

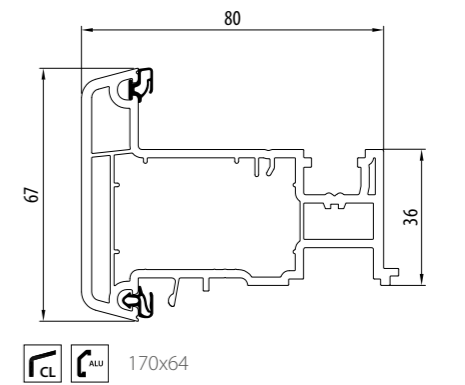
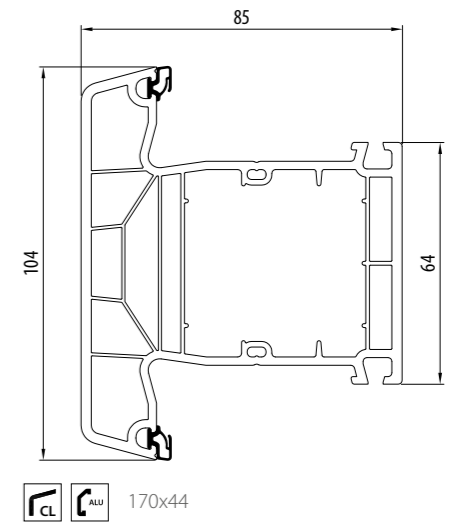
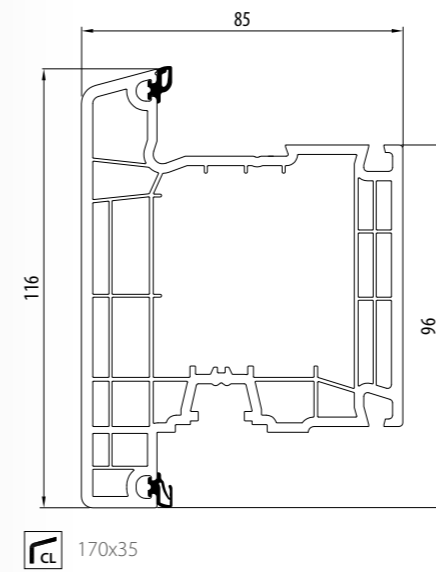
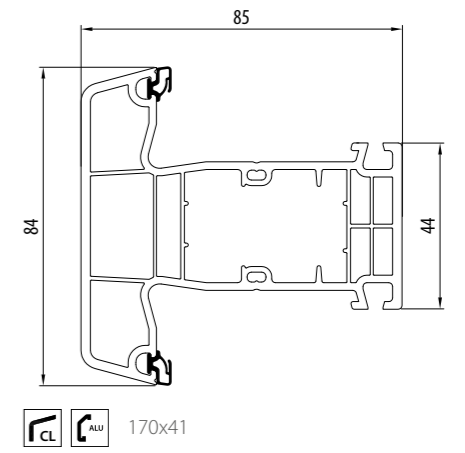
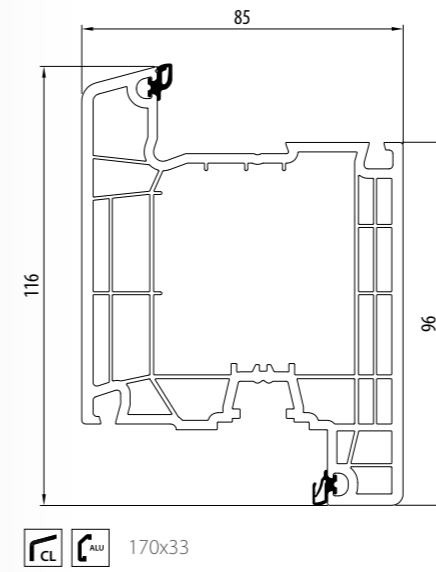
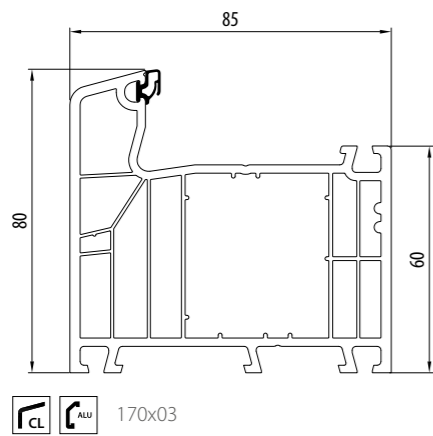
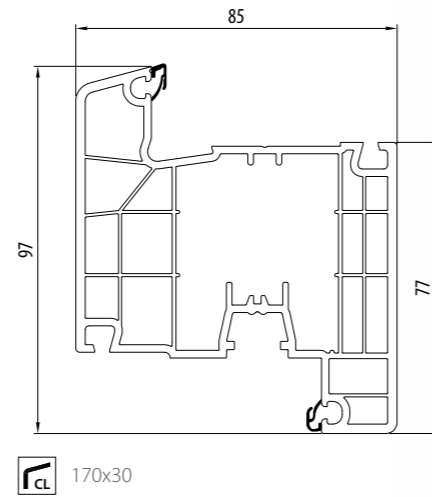
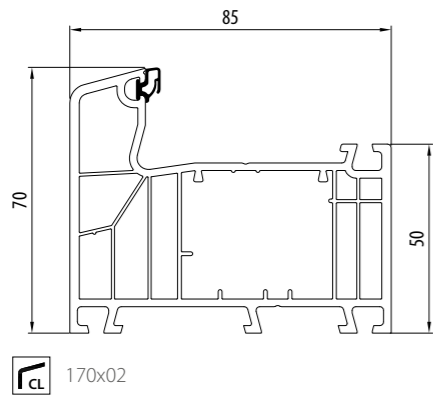
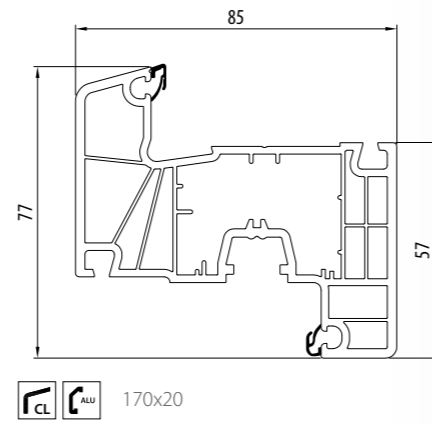
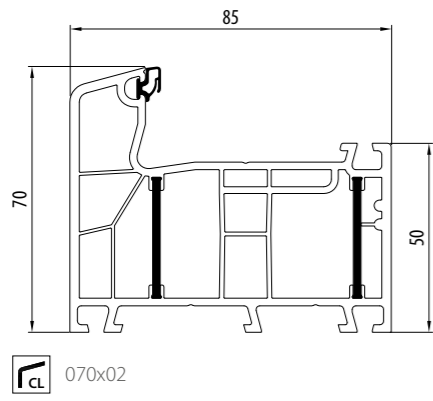

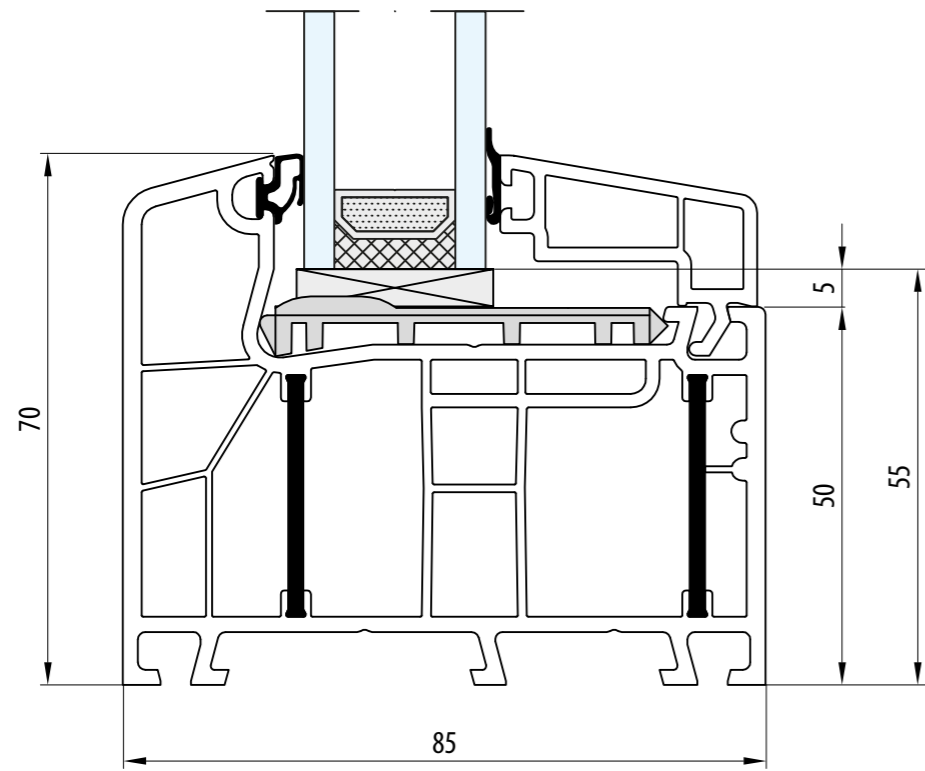

- Rama: 70 mm
- Dormant: 70 mm
- Frame: 70 mm
- Rahmen: 70 mm
- Telaio: 70 mm

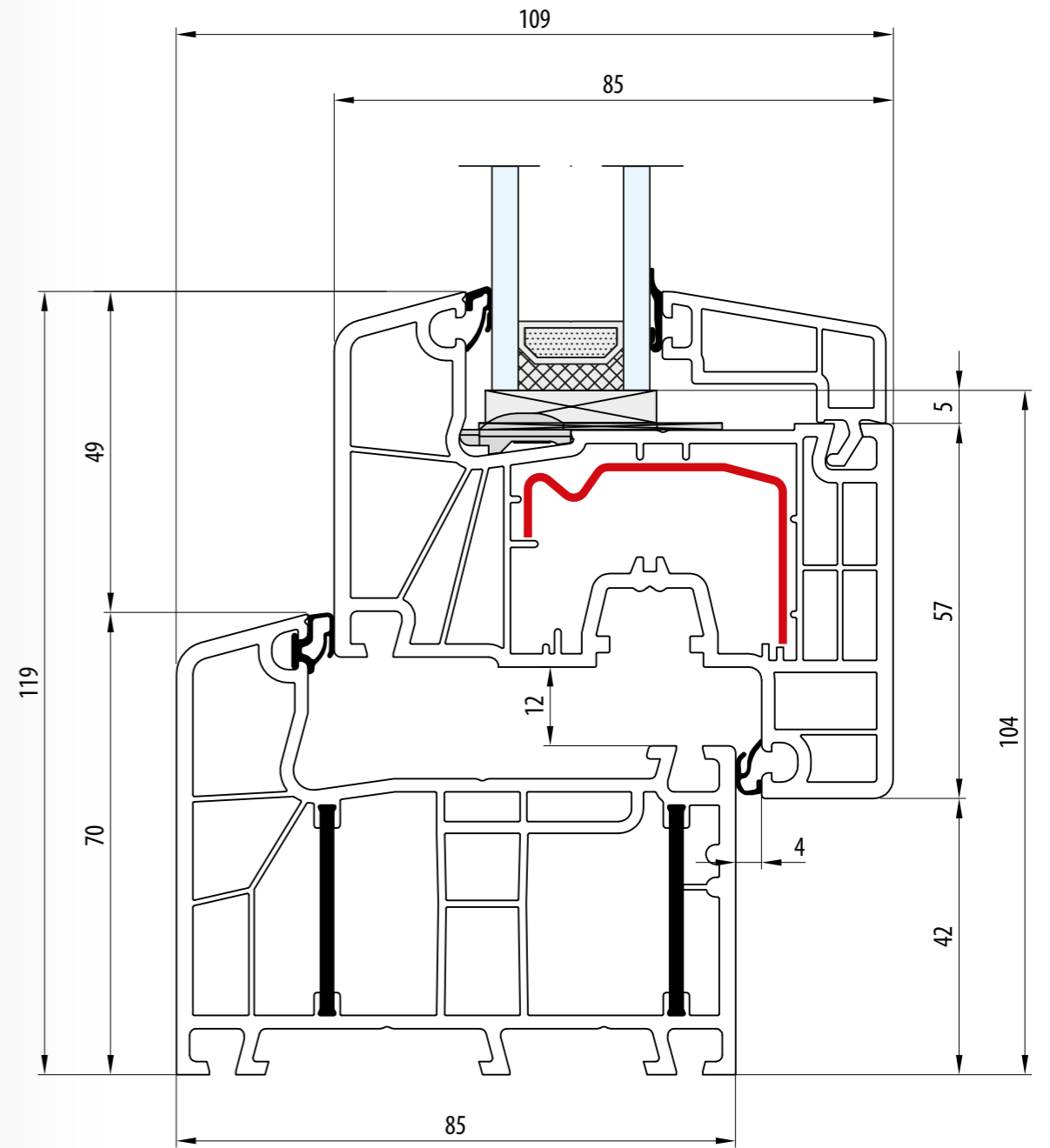
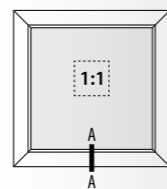

- Rama: 70 mm · Skrzydło: 97 mm
- Dormant: 70 mm · Vantail: 97 mm
- Frame: 70 mm · Sash: 97 mm
- Rahmen: 70 mm · Flügel: 97 mm
- Telaio: 70 mm · Anta: 97 mm

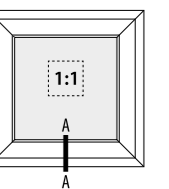

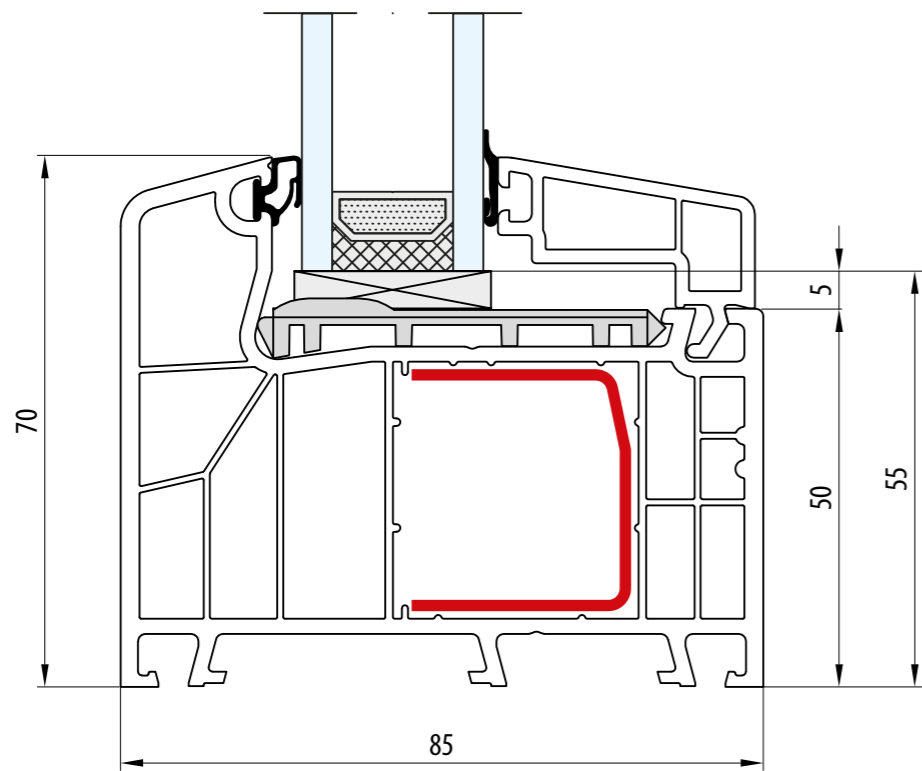

- Rama: 70 mm
- Dormant: 70 mm
- Frame: 70 mm
- Rahmen: 70 mm
- Telaio: 70 mm

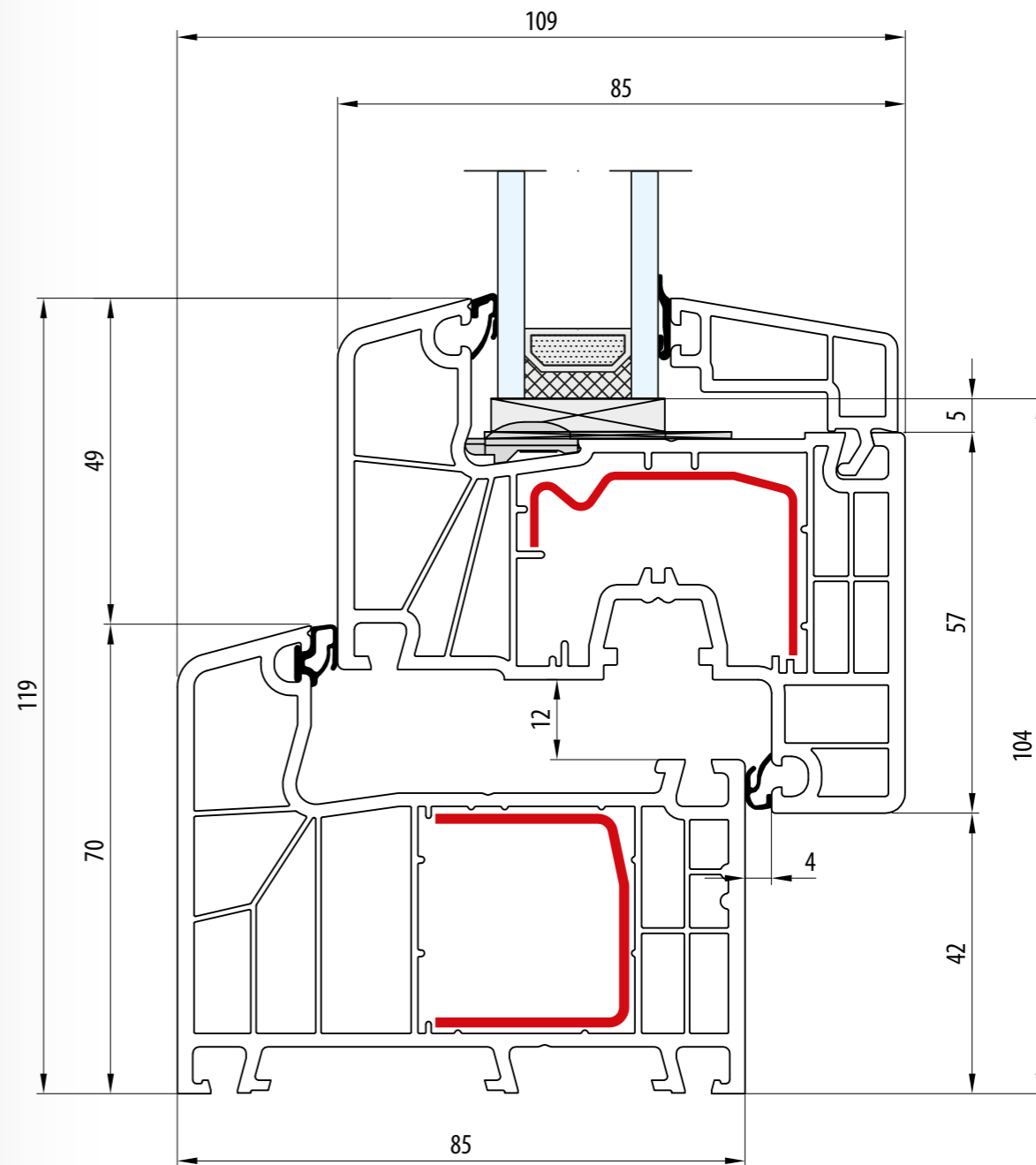
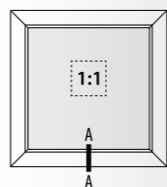

- Rama: 70 mm · Skrzydło: 77 mm
- Dormant: 70 mm · Vantail: 77 mm
- Frame: 70 mm · Sash: 77 mm
- Rahmen: 70 mm · Flügel: 77 mm
- Telaio: 70 mm · Anta: 77 mm

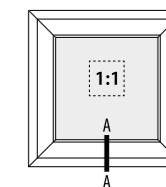

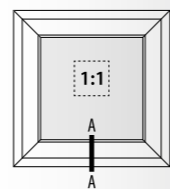
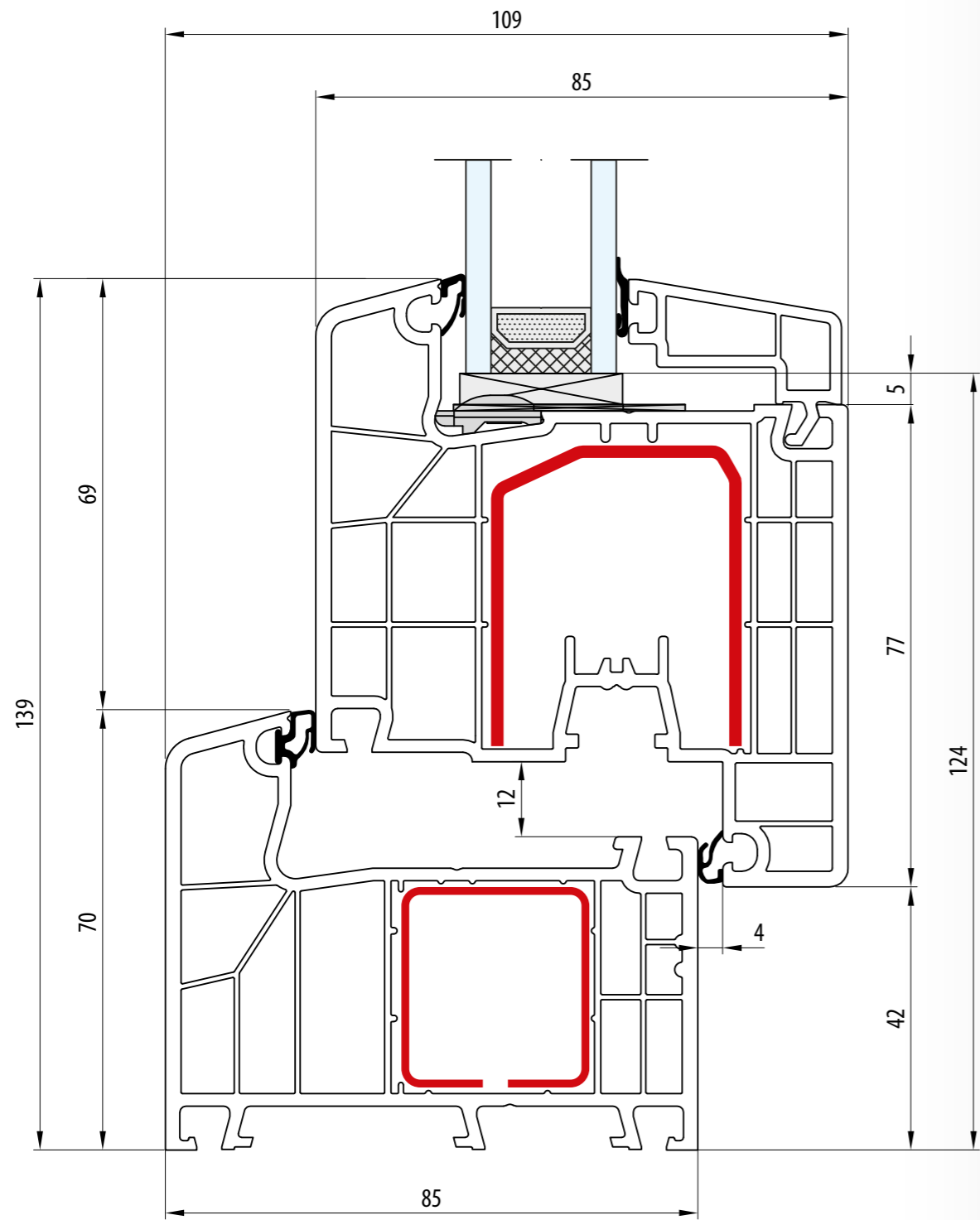

- Rama: 70 mm · Skrzydło: 97 mm
- Dormant: 70 mm · Vantail: 97 mm
- Frame: 70 mm · Sash: 97 mm
- Rahmen: 70 mm · Flügel: 97 mm
- Telaio: 70 mm · Anta: 97 mm

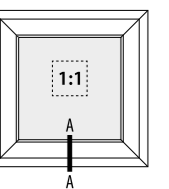
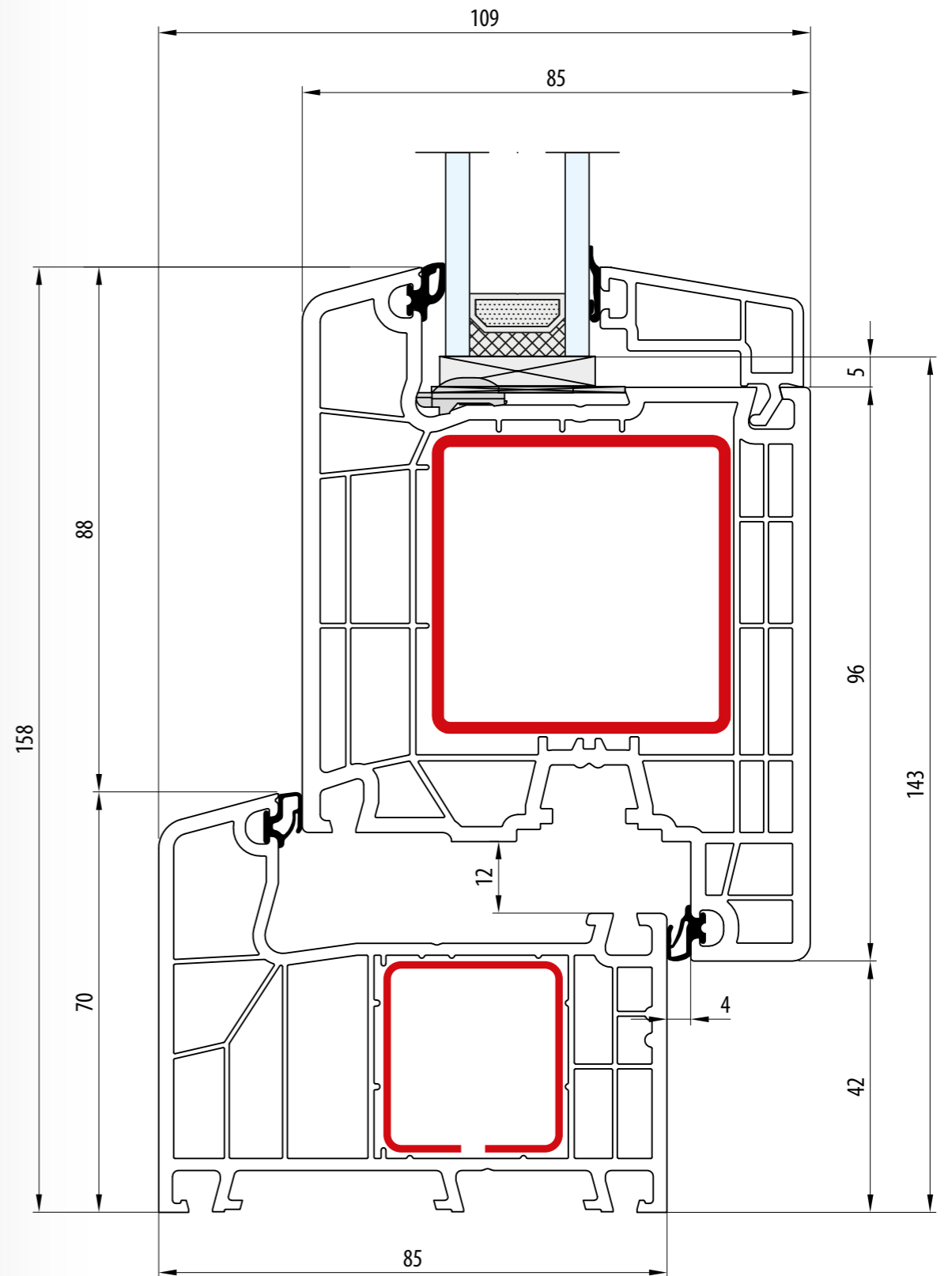

- Rama: 70 mm · Skrzydło: 116 mm
- Dormant: 70 mm · Vantail: 116 mm
- Frame: 70 mm · Sash: 116 mm
- Rahmen: 70 mm · Flügel: 116 mm
- Telaio: 70 mm · Anta: 116 mm

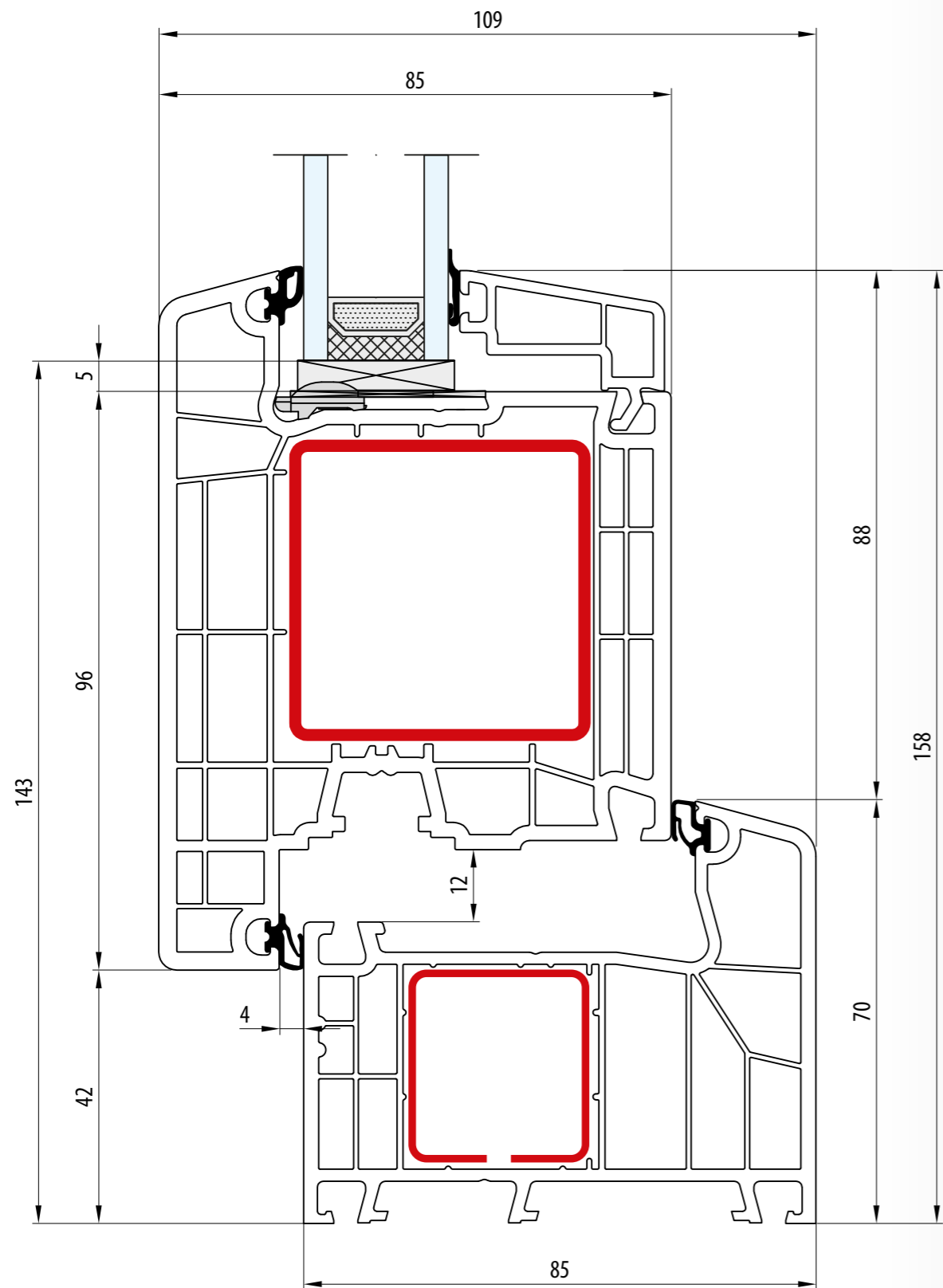

- Rama: 70 mm · Skrzydło: 116 mm
- Dormant: 70 mm · Vantail: 116 mm
- Frame: 70 mm · Sash: 116 mm
- Rahmen: 70 mm · Flügel: 116 mm
- Telaio: 70 mm · Anta: 116 mm

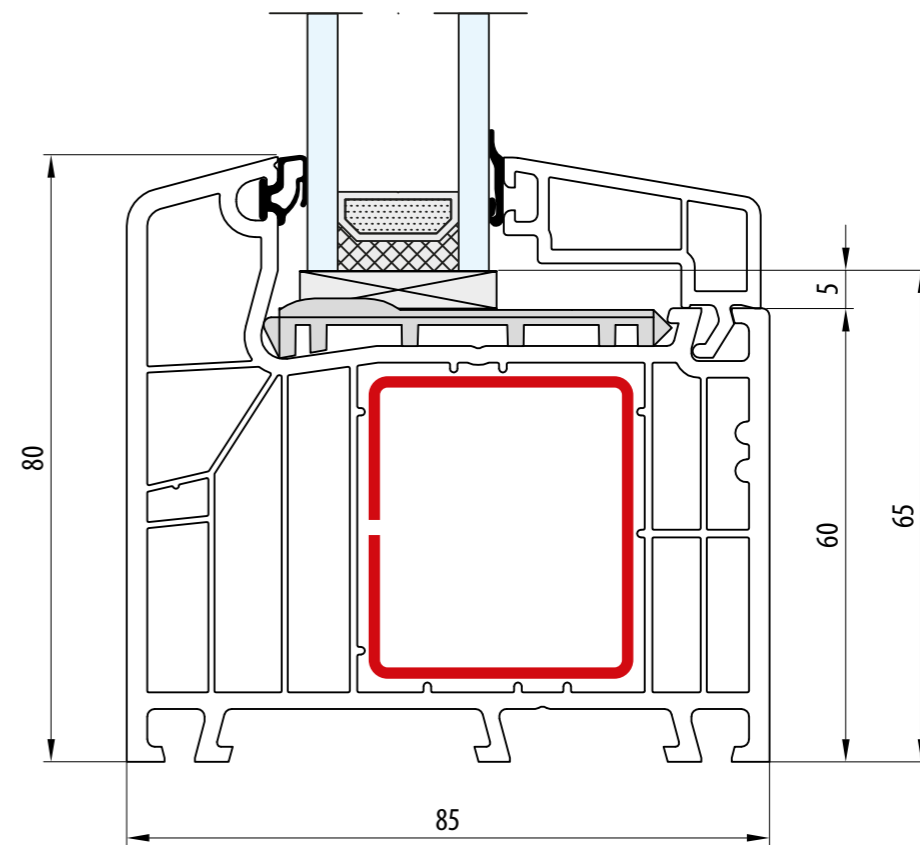
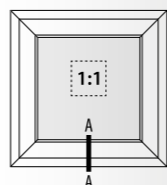

- Rama: 80 mm
- Dormant: 80 mm
- Frame: 80 mm
- Rahmen: 80 mm
- Telaio: 80 mm

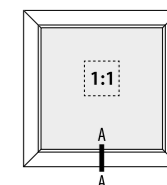

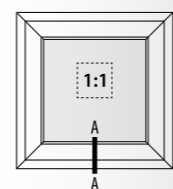
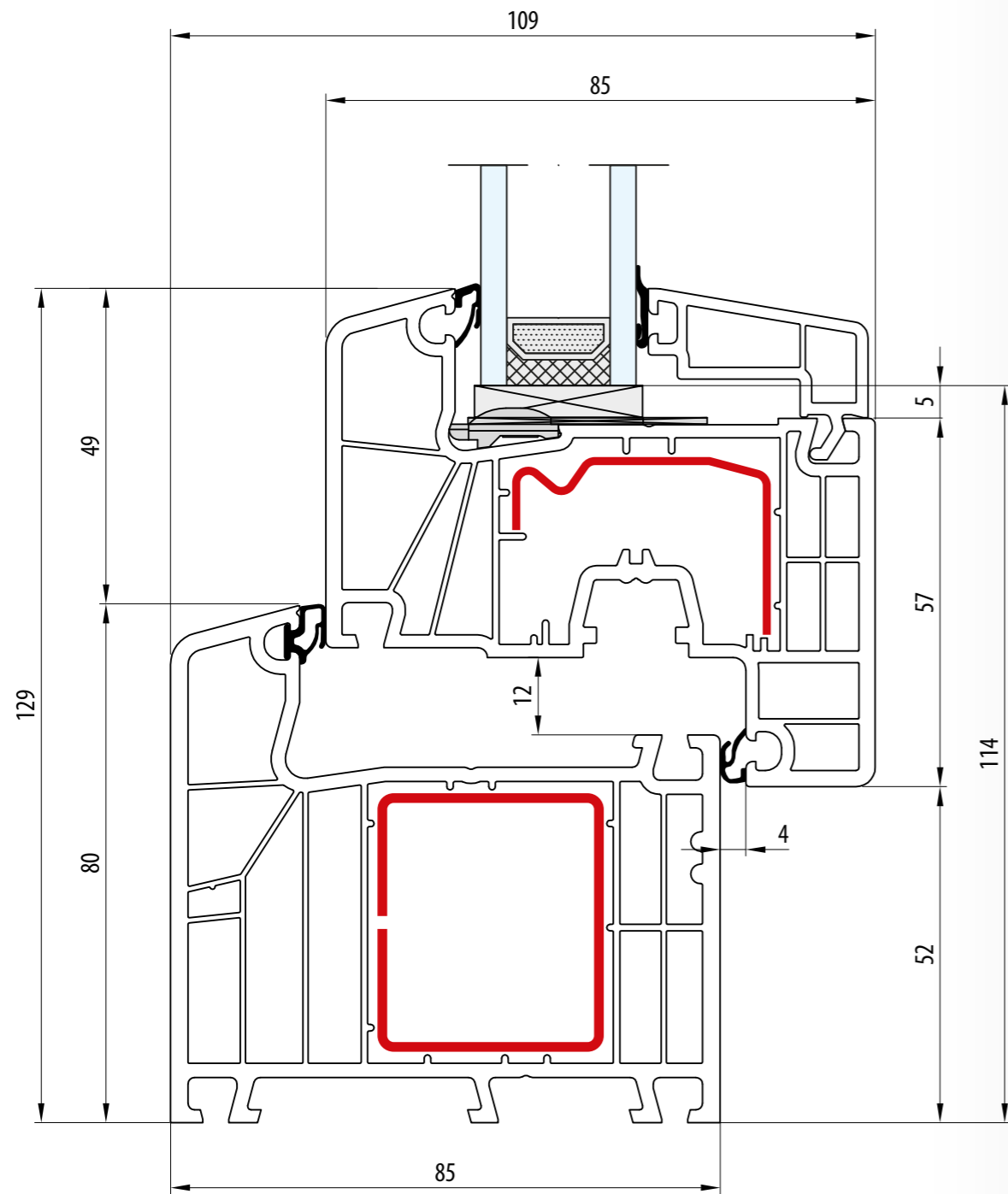

- Rama: 80 mm · Skrzydło: 77 mm
- Dormant: 80 mm · Vantail: 77 mm
- Frame: 80 mm · Sash: 77 mm
- Rahmen: 80 mm · Flügel: 77 mm
- Telaio: 80 mm · Anta: 77 mm

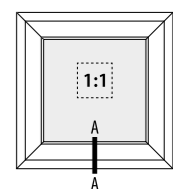
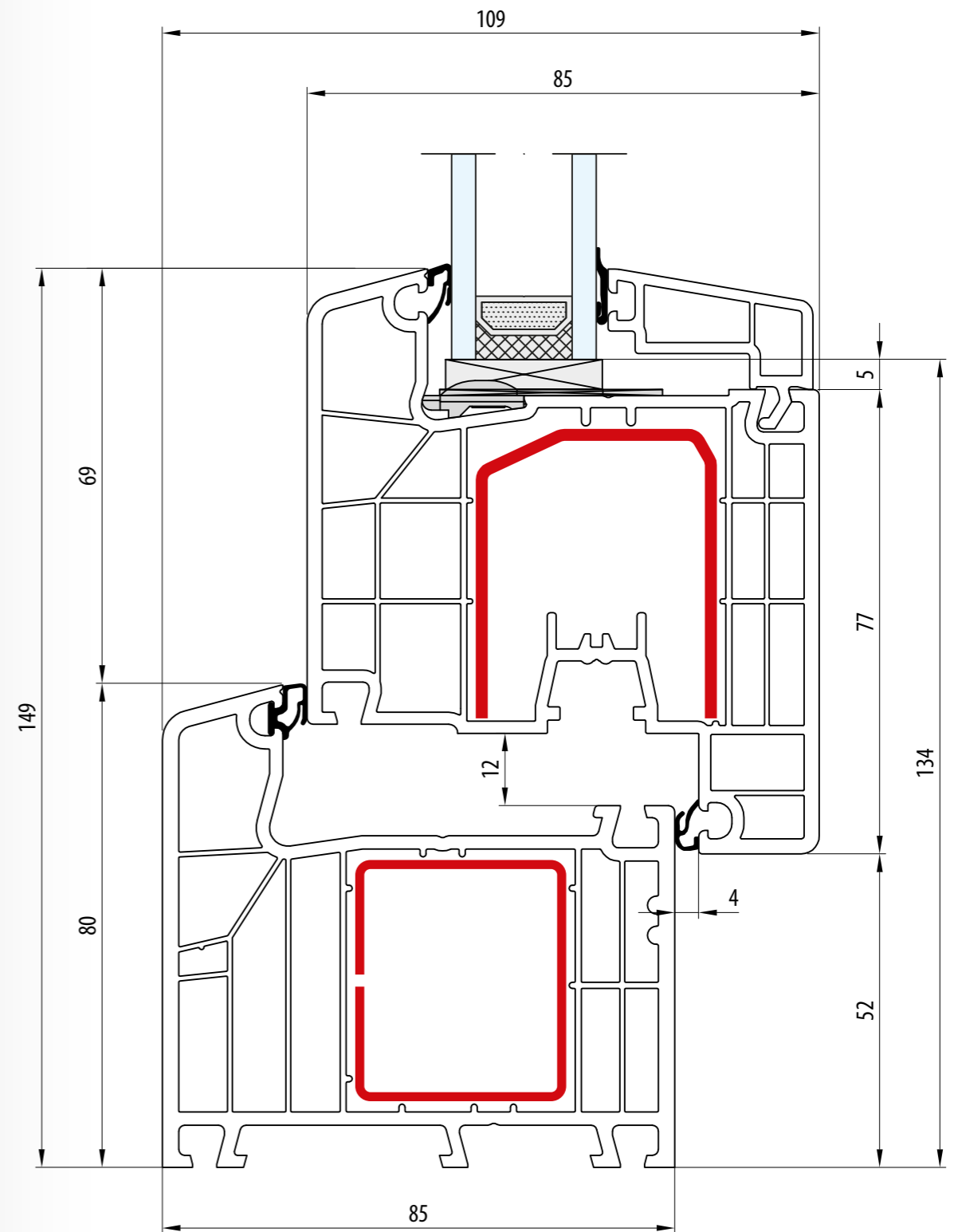

- Rama: 80 mm · Skrzydło: 97 mm
- Dormant: 80 mm · Vantail: 97 mm
- Frame: 80 mm · Sash: 97 mm
- Rahmen: 80 mm · Flügel: 97 mm
- Telaio: 80 mm · Anta: 97 mm

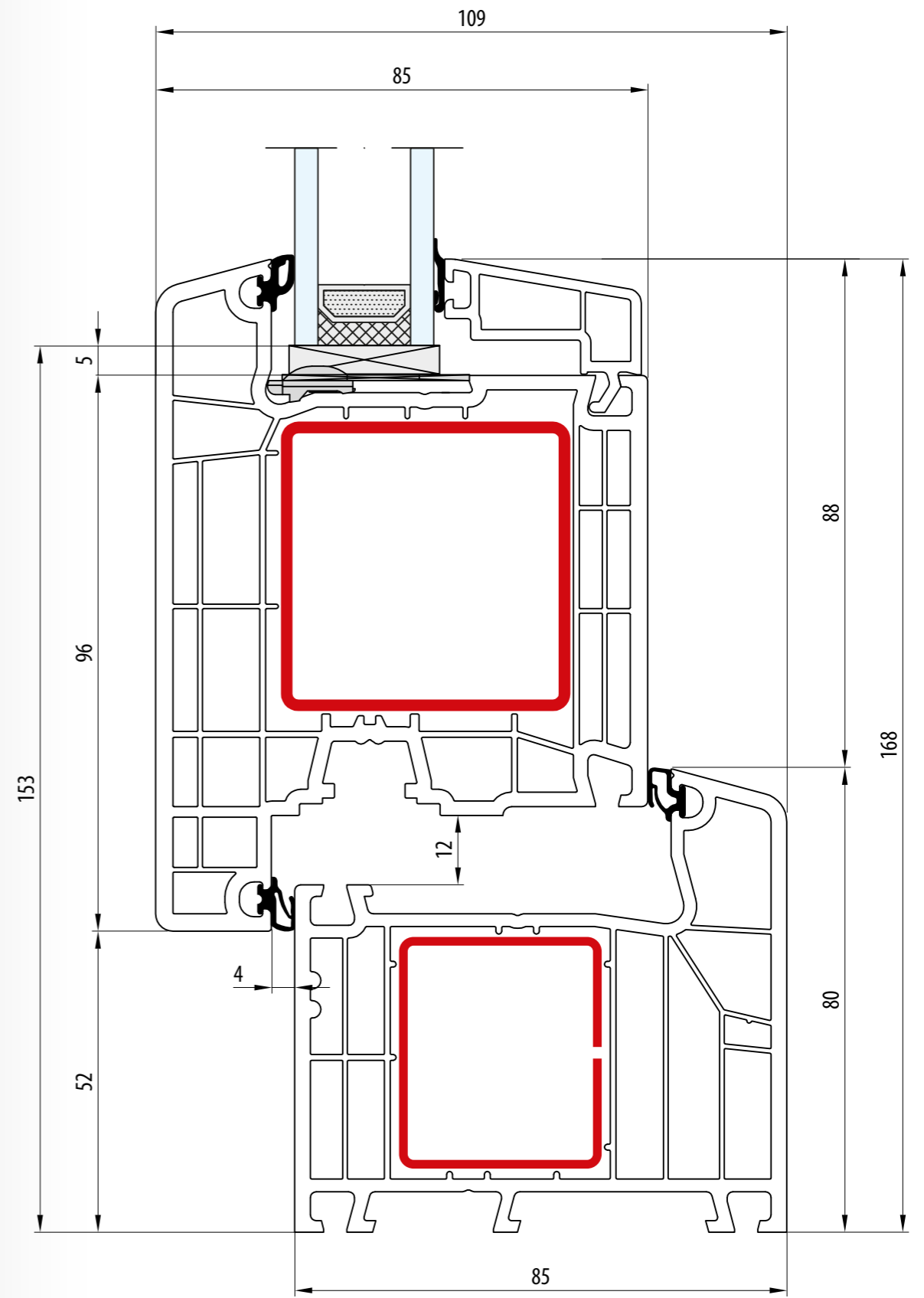
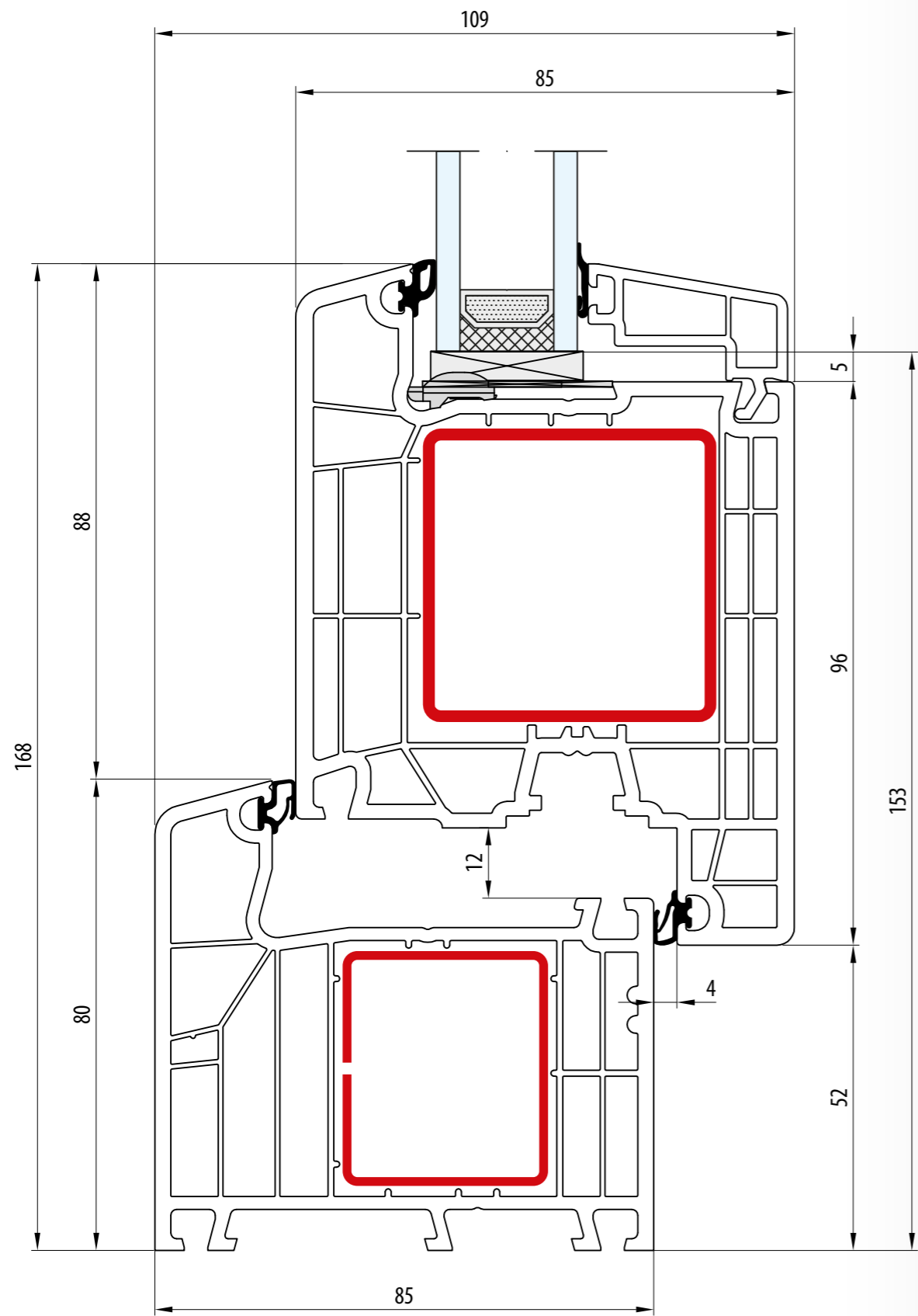

- Rama: 80 mm · Skrzydło: 116 mm
- Dormant: 80 mm · Vantail: 116 mm
- Frame: 80 mm · Sash: 116 mm
- Rahmen: 80 mm · Flügel: 116 mm
- Telaio: 80 mm · Anta: 116 mm

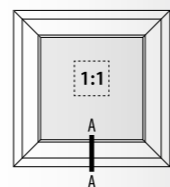

- Rama: 80 mm · Skrzydło: 116 mm
- Dormant: 80 mm · Vantail: 116 mm
- Frame: 80 mm · Sash: 116 mm
- Rahmen: 80 mm · Flügel: 116 mm
- Telaio: 80 mm · Anta: 116 mm

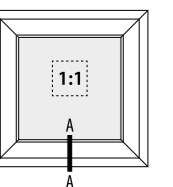

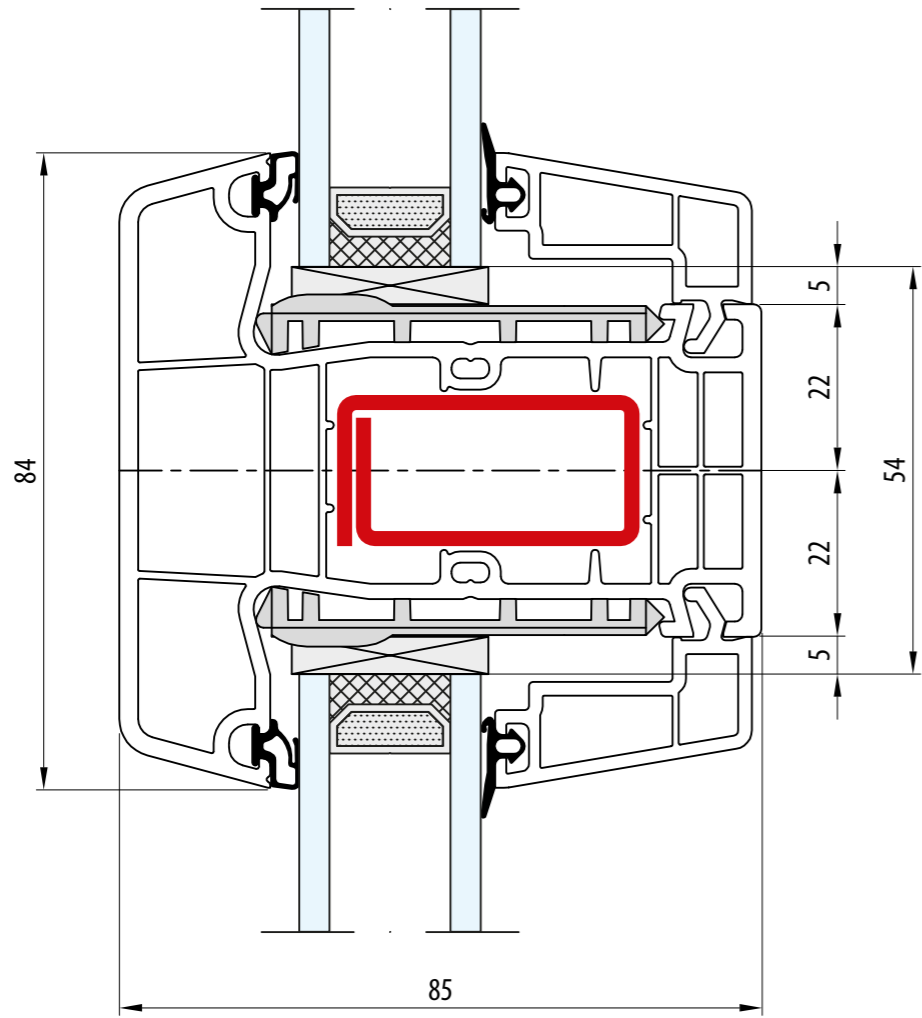

- Słupek stalowy: 84 mm
- Meneau fixe: 84 mm
- Fix post: 84 mm
- Festem Pfahl: 84 mm
- Montante fisso: 84 mm

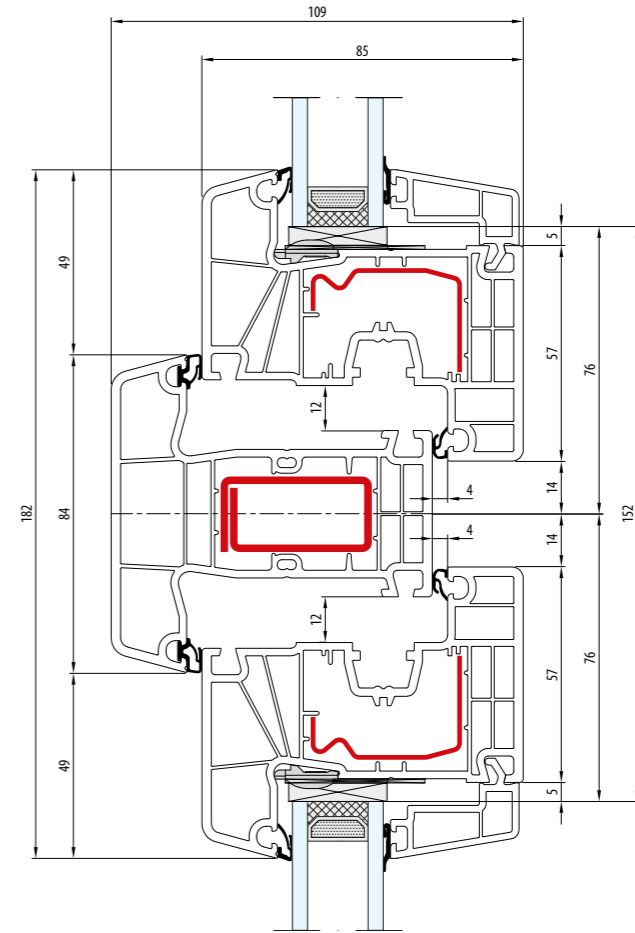
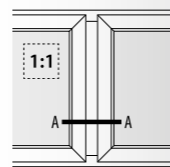

- Słupek stalowy: 84 mm · Skrzydło: 77 mm
- Meneau fixe: 84 mm · Vantail: 77 mm
- Fix post: 84 mm · Sash: 77 mm
- Festem Pfahl: 84 mm · Flügel: 77 mm
- Montante fisso: 84 mm · Anta: 77 mm

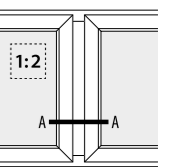

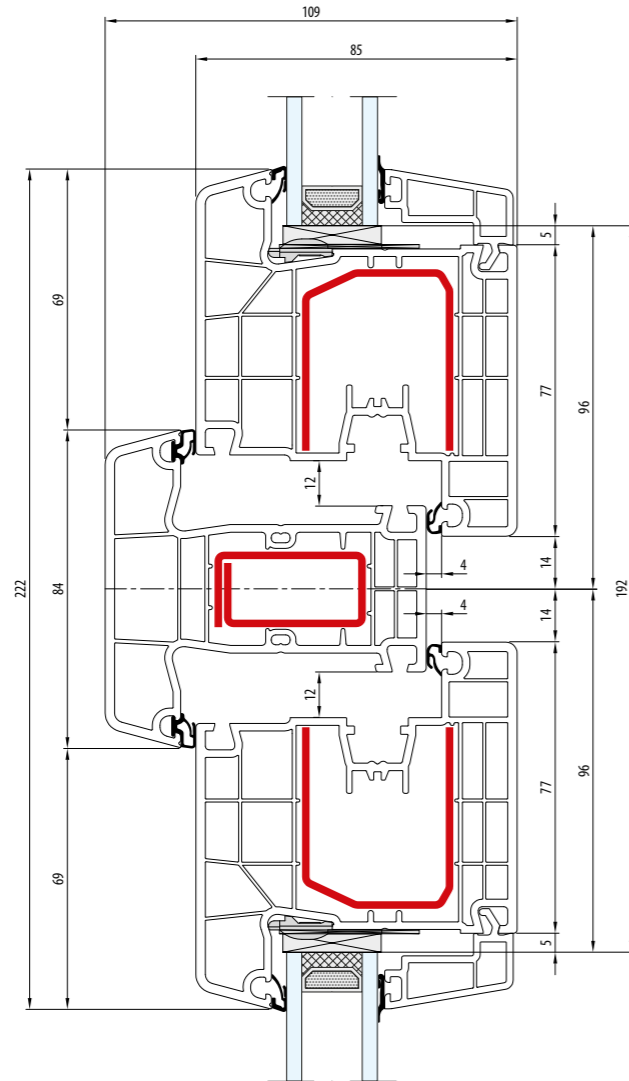

- Słupek stały: 84 mm · Skrzydło: 97 mm
- Meneau fixe: 84 mm · Vantail: 97 mm
- Fix post: 84 mm · Sash: 97 mm
- Festem Pfahl: 84 mm · Flügel: 97 mm
- Montante fisso: 84 mm · Anta: 97 mm

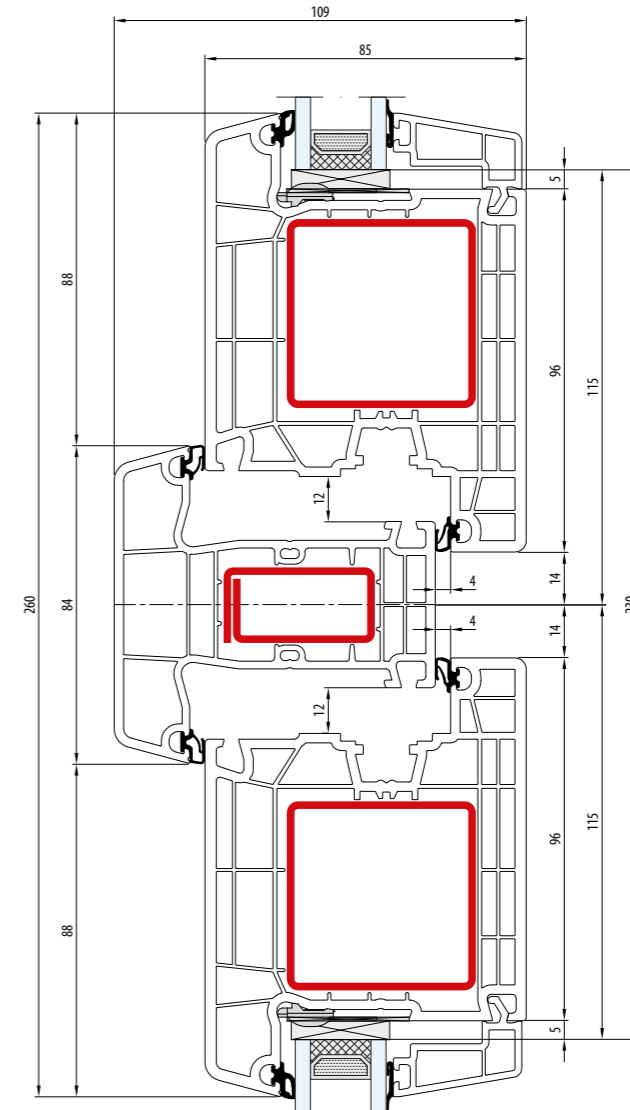
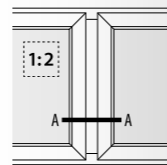

- Słupek stały: 84 mm · Skrzydło: 116 mm
- Meneau fixe: 84 mm · Vantail: 116 mm
- Fix post: 84 mm · Sash: 116 mm
- Festem Pfahl: 84 mm · Flügel: 116 mm
- Montante fisso: 84 mm · Anta: 116 mm

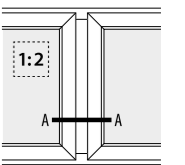

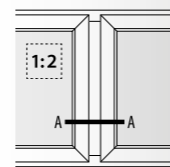
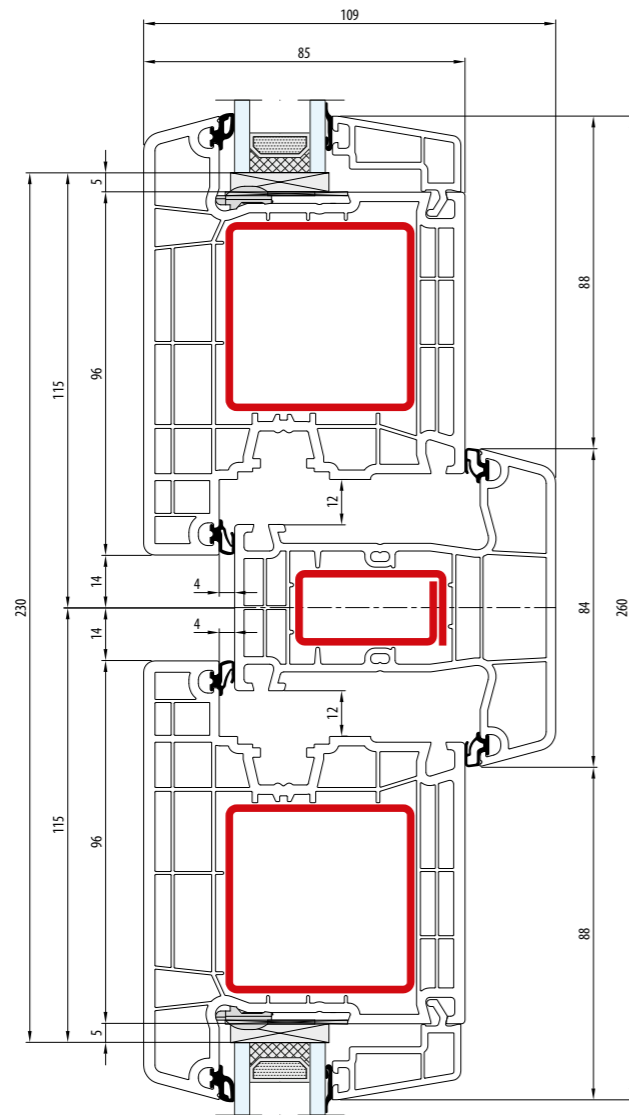

- Słupek stalowy: 84 mm · Skrzydło: 116 mm
- Meneau fixe: 84 mm · Vantail: 116 mm
- Fix post: 84 mm · Sash: 116 mm
- Festem Pfahl: 84 mm · Flügel: 116 mm
- Montante fisso: 84 mm · Anta: 116 mm

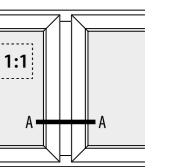
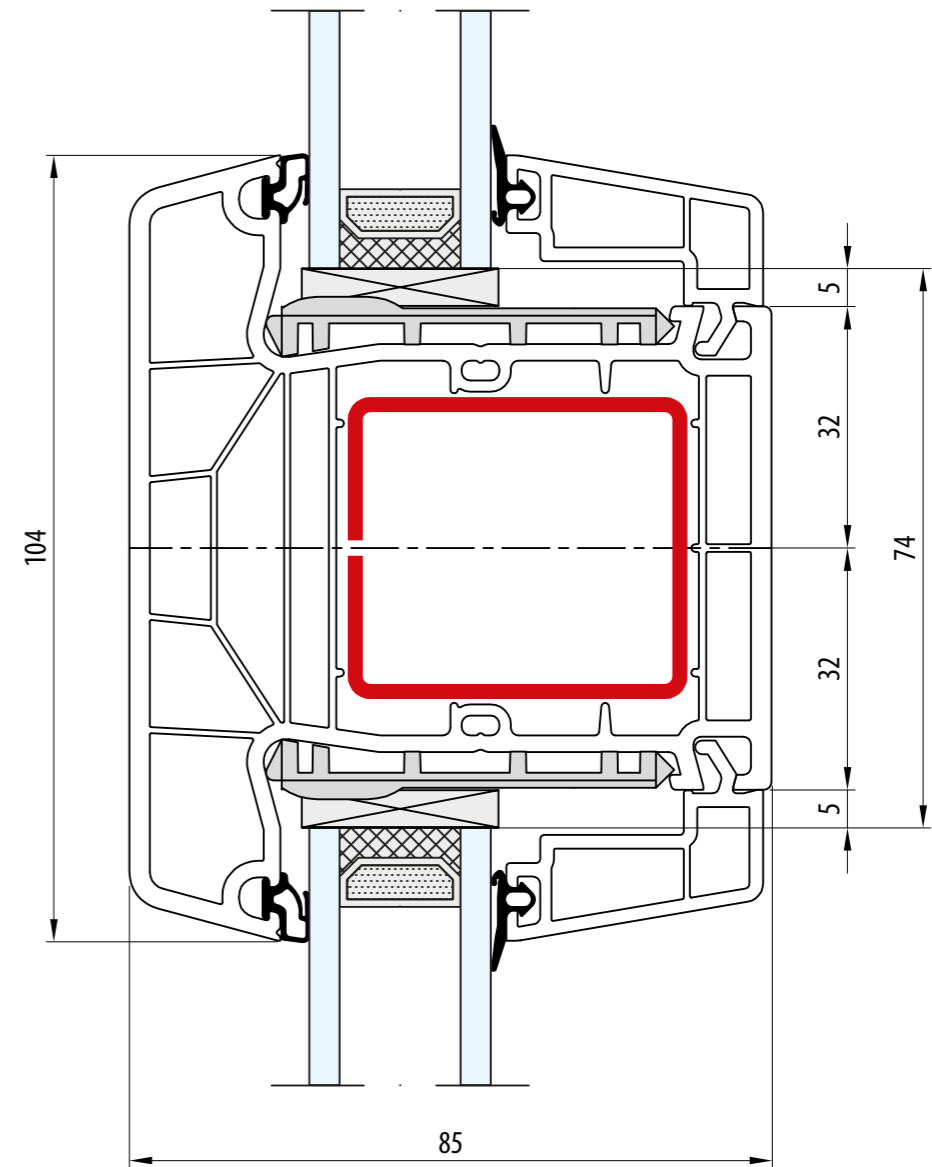

- Słupek stalowy: 104 mm
- Meneau fixe: 104 mm
- Fix post: 104 mm
- Festem Pfahl: 104 mm
- Montante fisso: 104 mm

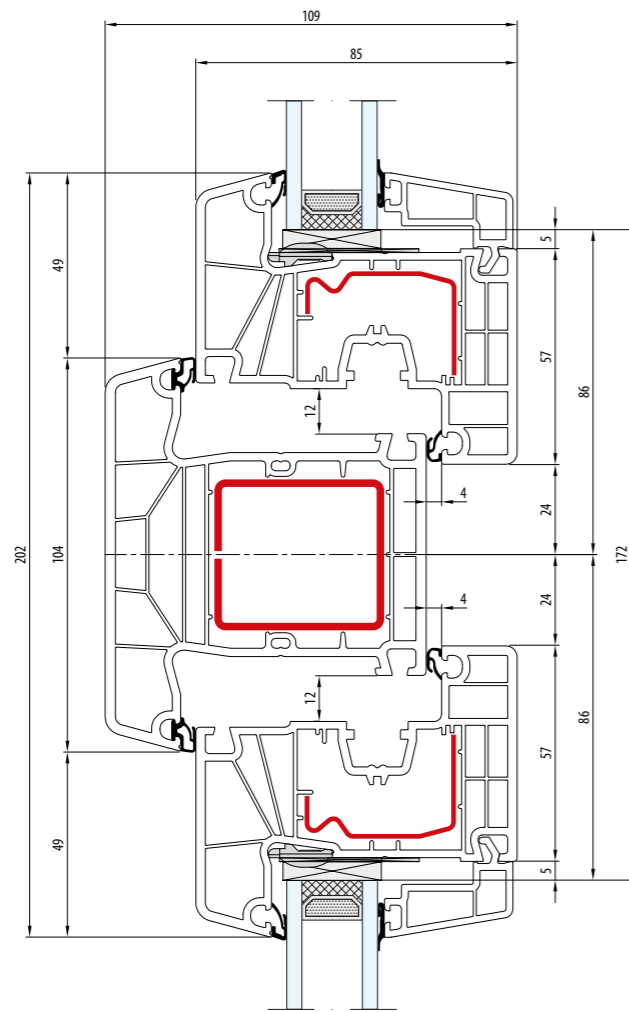

- Słupek stały: 104 mm · Skrzydło: 77 mm
- Meneau fixe: 104 mm · Vantail: 77 mm
- Fix post: 104 mm · Sash: 77 mm
- Festem Pfahl: 104 mm · Flügel: 77 mm
- Montante fisso: 104 mm · Anta: 77 mm

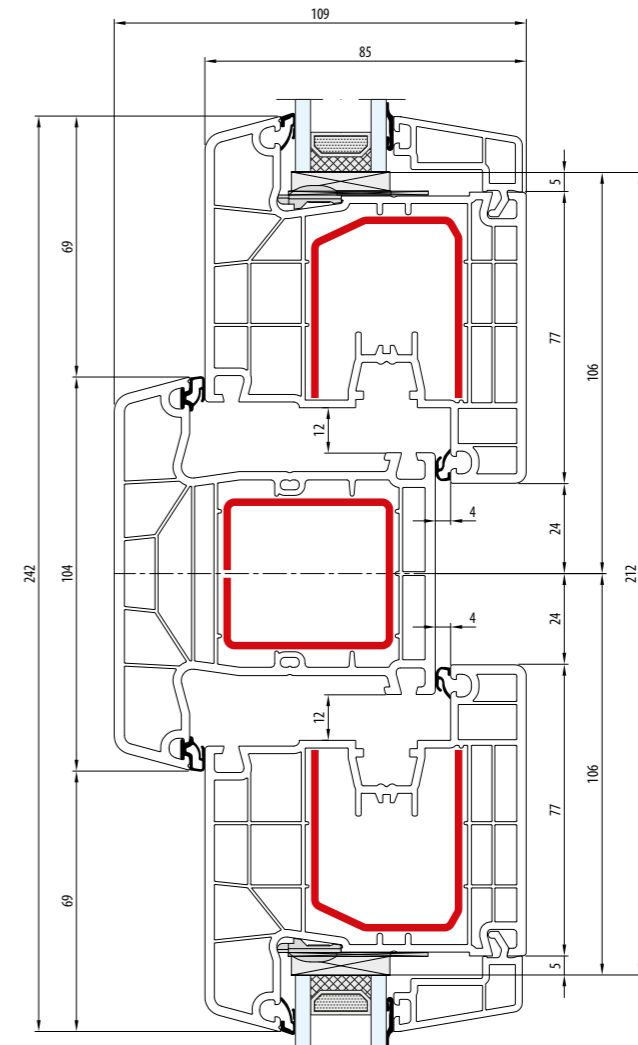
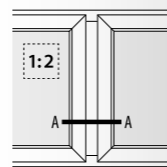

- Słupek stały: 104 mm · Skrzydło: 97 mm
- Meneau fixe: 104 mm · Vantail: 97 mm
- Fix post: 104 mm · Sash: 97 mm
- Festem Pfahl: 104 mm · Flügel: 97 mm
- Montante fisso: 104 mm · Anta: 97 mm

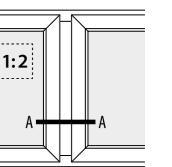

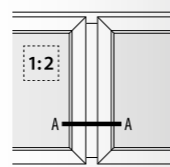
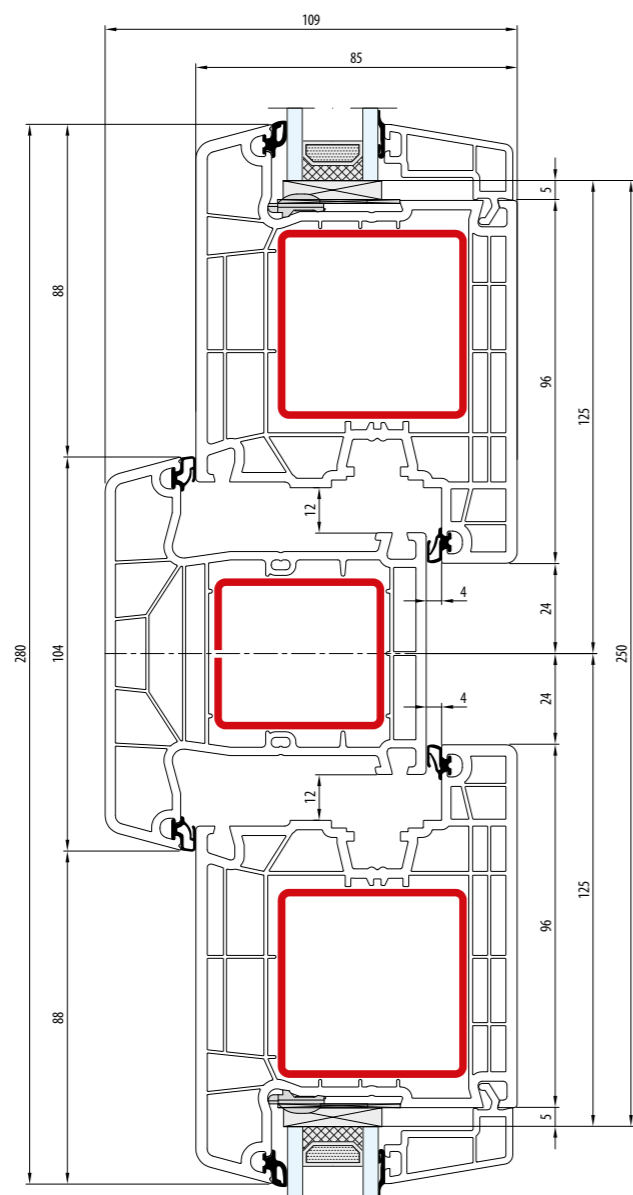

- Słupek stały: 104 mm · Skrzydło: 116 mm
- Meneau fixe: 104 mm · Vantail: 116 mm
- Fix post: 104 mm · Sash: 116 mm
- Festem Pfahl: 104 mm · Flügel: 116 mm
- Montante fisso: 104 mm · Anta: 116 mm

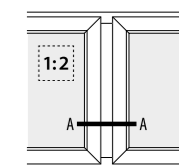
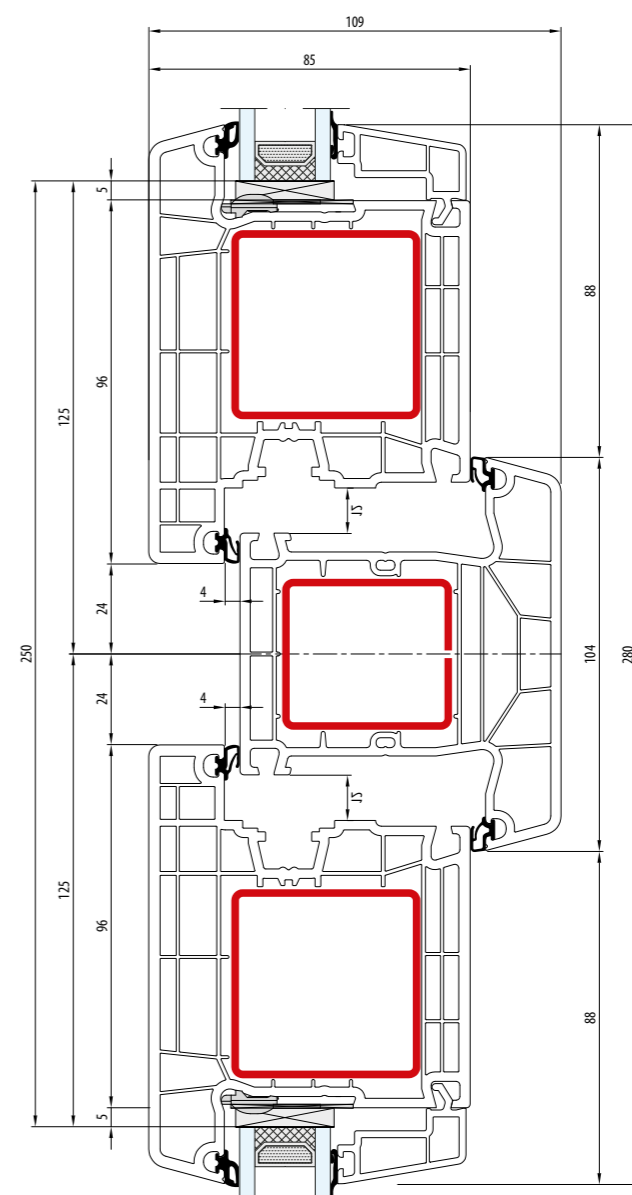

- Słupek stały: 104 mm · Skrzydło: 116 mm
- Meneau fixe: 104 mm · Vantail: 116 mm
- Fix post: 104 mm · Sash: 116 mm
- Festem Pfahl: 104 mm · Flügel: 116 mm
- Montante fisso: 104 mm · Anta: 116 mm

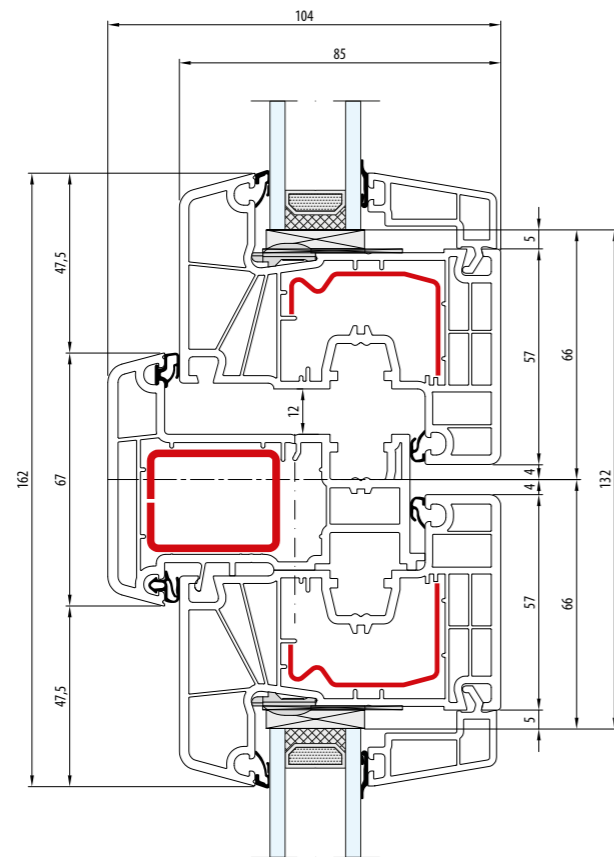

- Słupek ruchomy: 67 mm · Skrzydło: 77 mm
- Meneau mobile: 67 mm · Vantail: 77 mm
- Movable post: 67 mm · Sash: 77 mm
- Stulp: 67 mm · Flügel: 77 mm
- Montante mobile: 67 mm · Anta: 77 mm

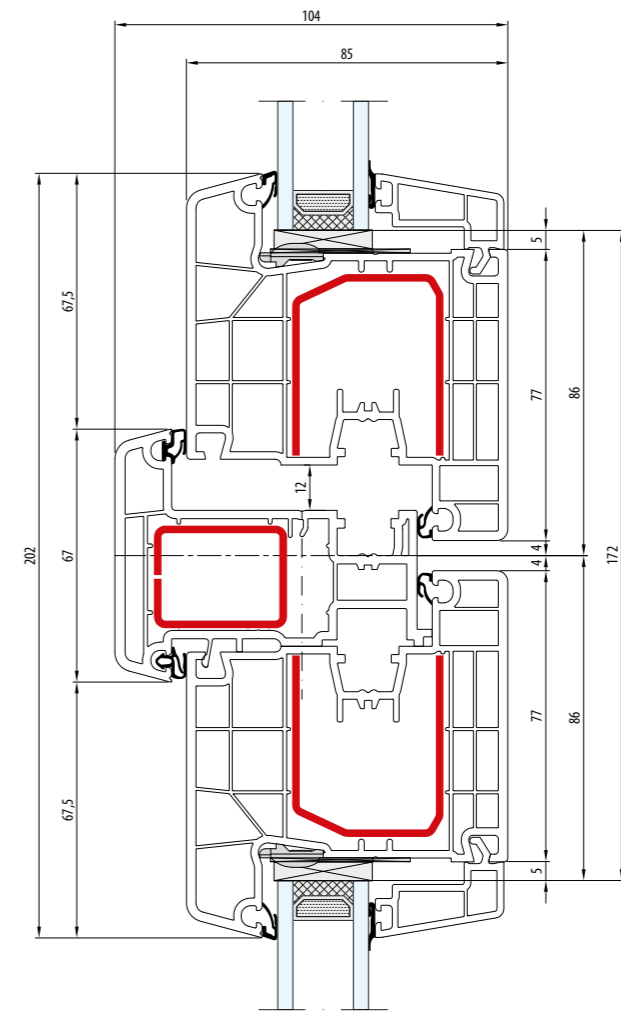
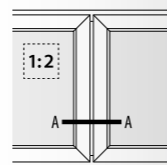

- Słupek ruchomy: 67 mm · Skrzydło: 97 mm
- Meneau mobile: 67 mm · Vantail: 97 mm
- Movable post: 67 mm · Sash: 97 mm
- Stulp: 67 mm · Flügel: 97 mm
- Montante mobile: 67 mm · Anta: 97 mm

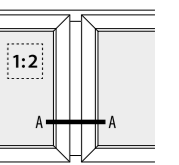

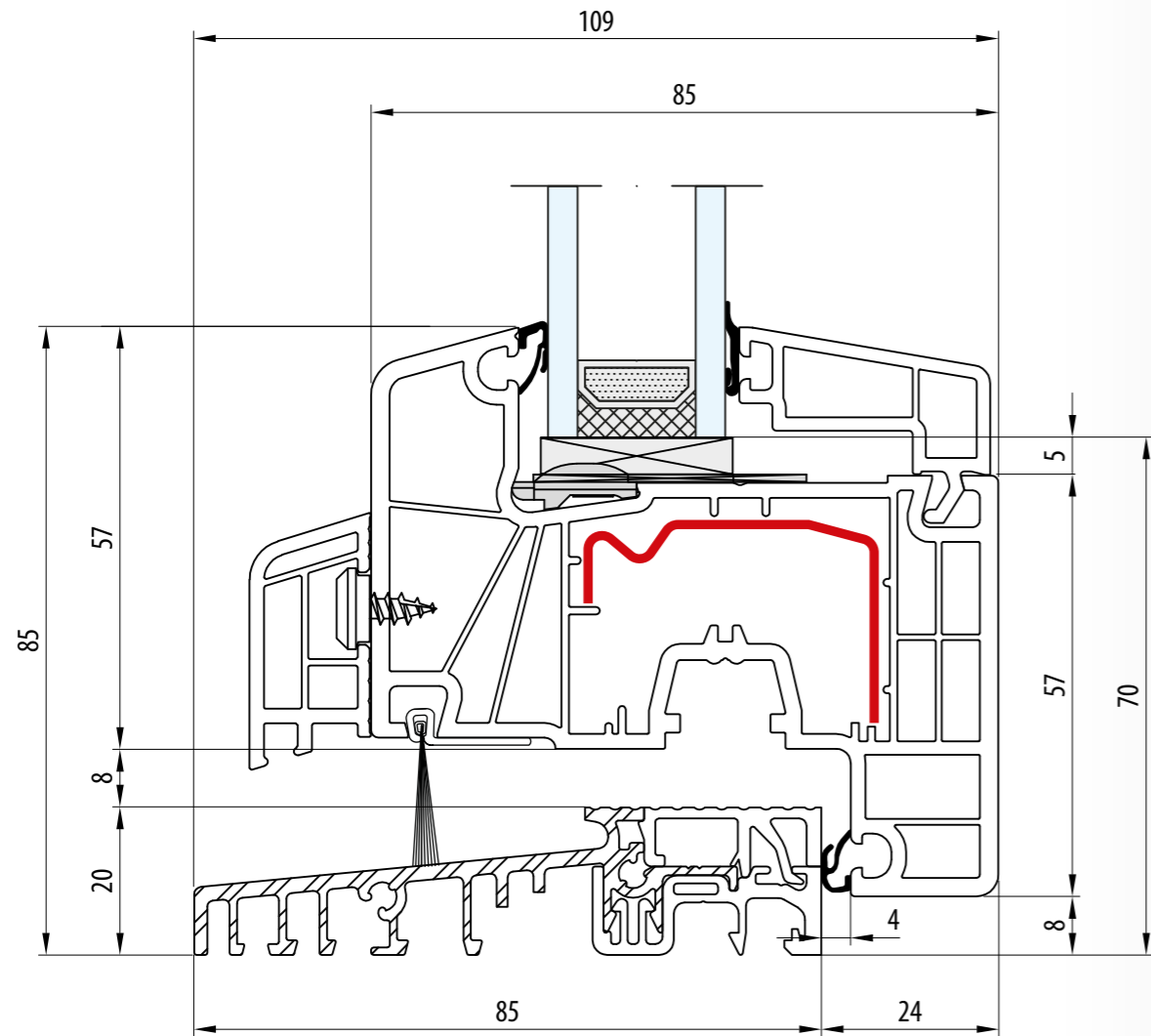

- Próg: 20 mm · Skrzydło: 77 mm
- Seuil: 20 mm · Vantail: 77 mm
- Threshold: 20 mm · Sash: 77 mm
- Schwelle: 20 mm · Flügel: 77 mm
- Soglia: 20 mm · Anta: 77 mm

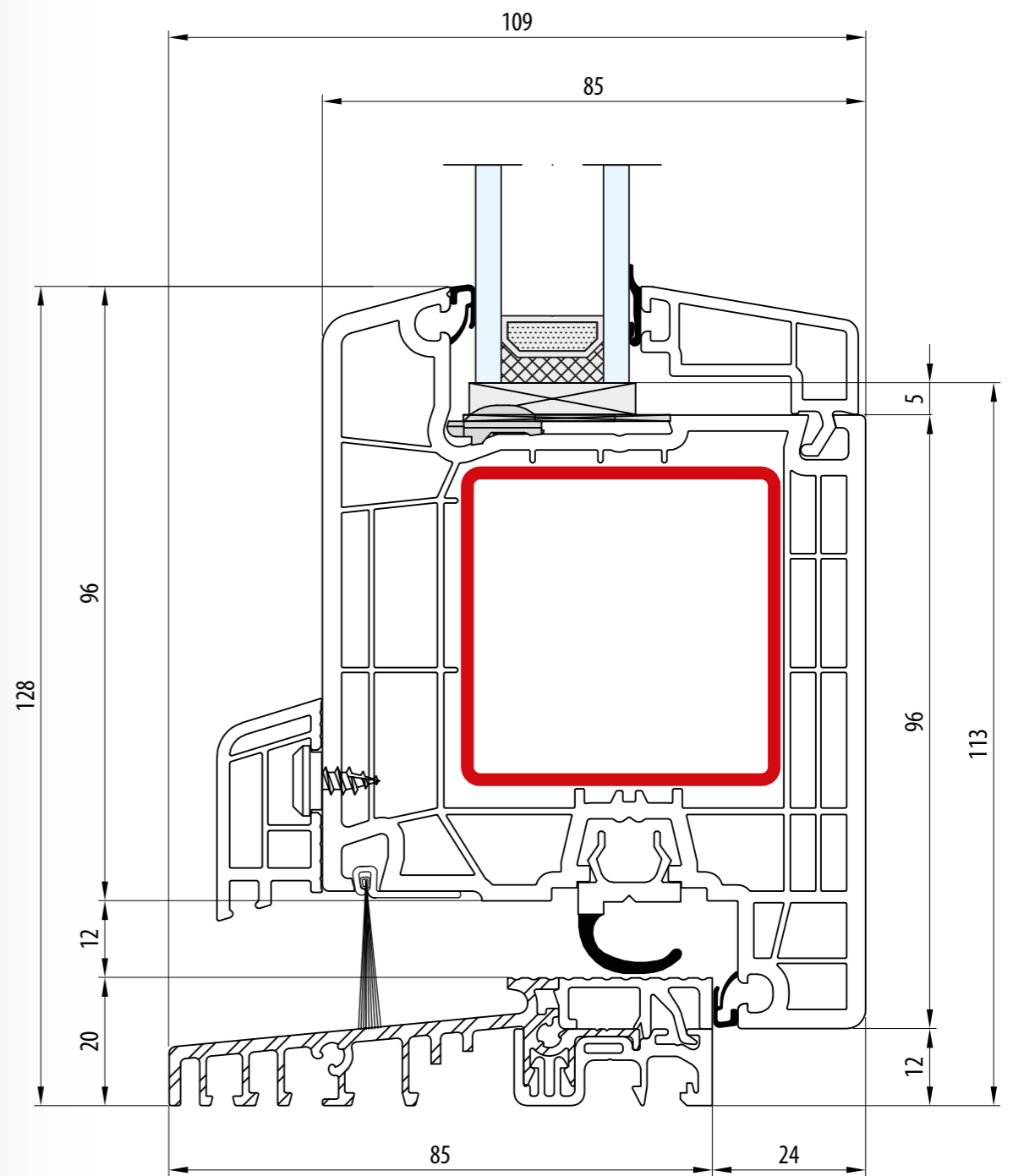
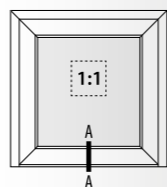

- Próg: 20 mm · Skrzydło: 116 mm
- Seuil: 20 mm · Vantail: 116 mm
- Threshold: 20 mm · Sash: 116 mm
- Schwelle: 20 mm · Flügel: 116 mm
- Soglia: 20 mm · Anta: 116 mm

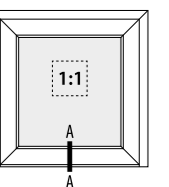

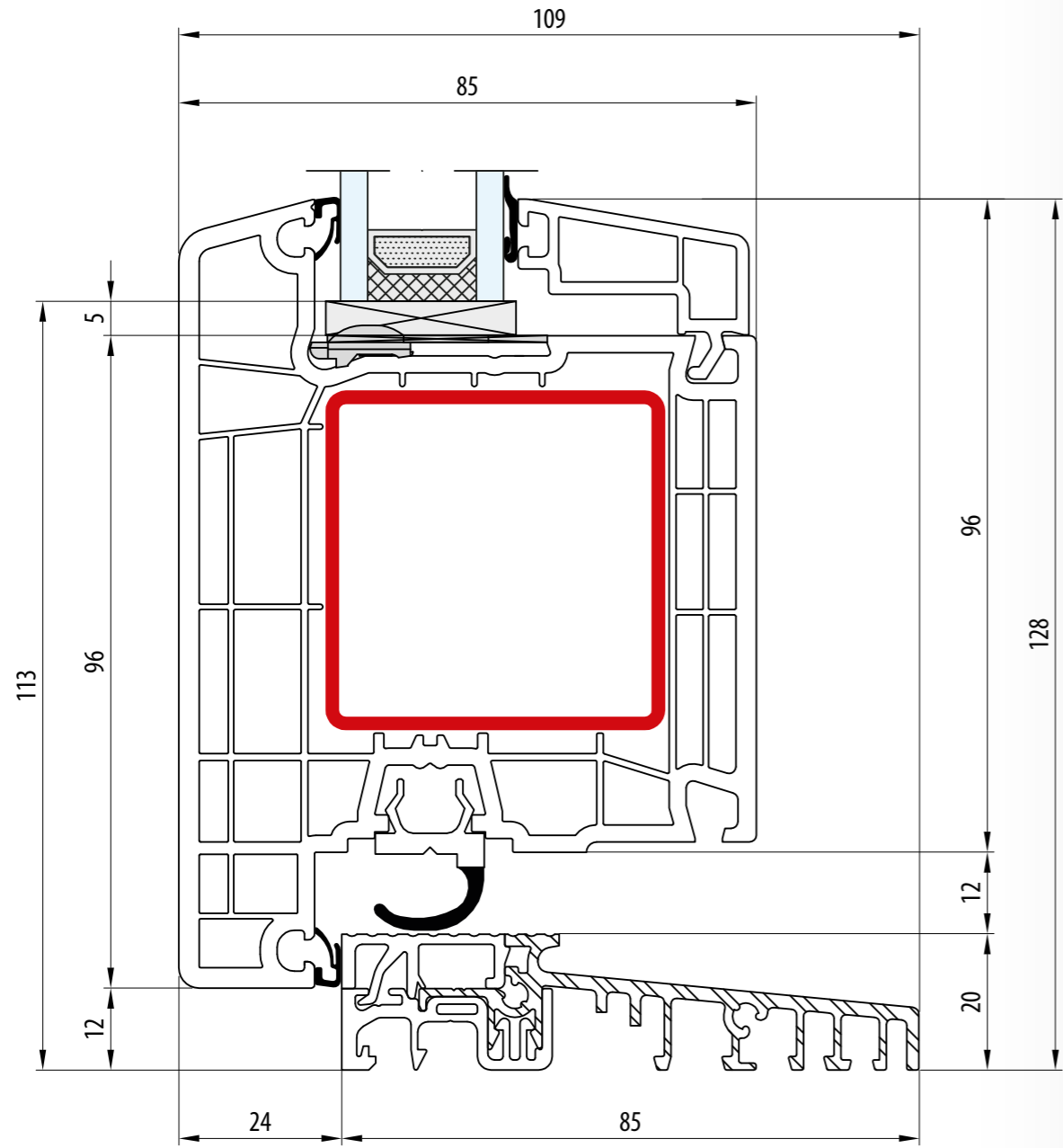

- Próg: 20 mm · Skrzydło: 116 mm
- Seuil: 20 mm · Vantail: 116 mm
- Threshold: 20 mm · Sash: 116 mm
- Schwelle: 20 mm · Flügel: 116 mm
- Soglia: 20 mm · Anta: 116 mm

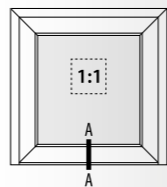

IDEAL 8000

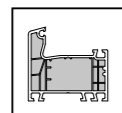
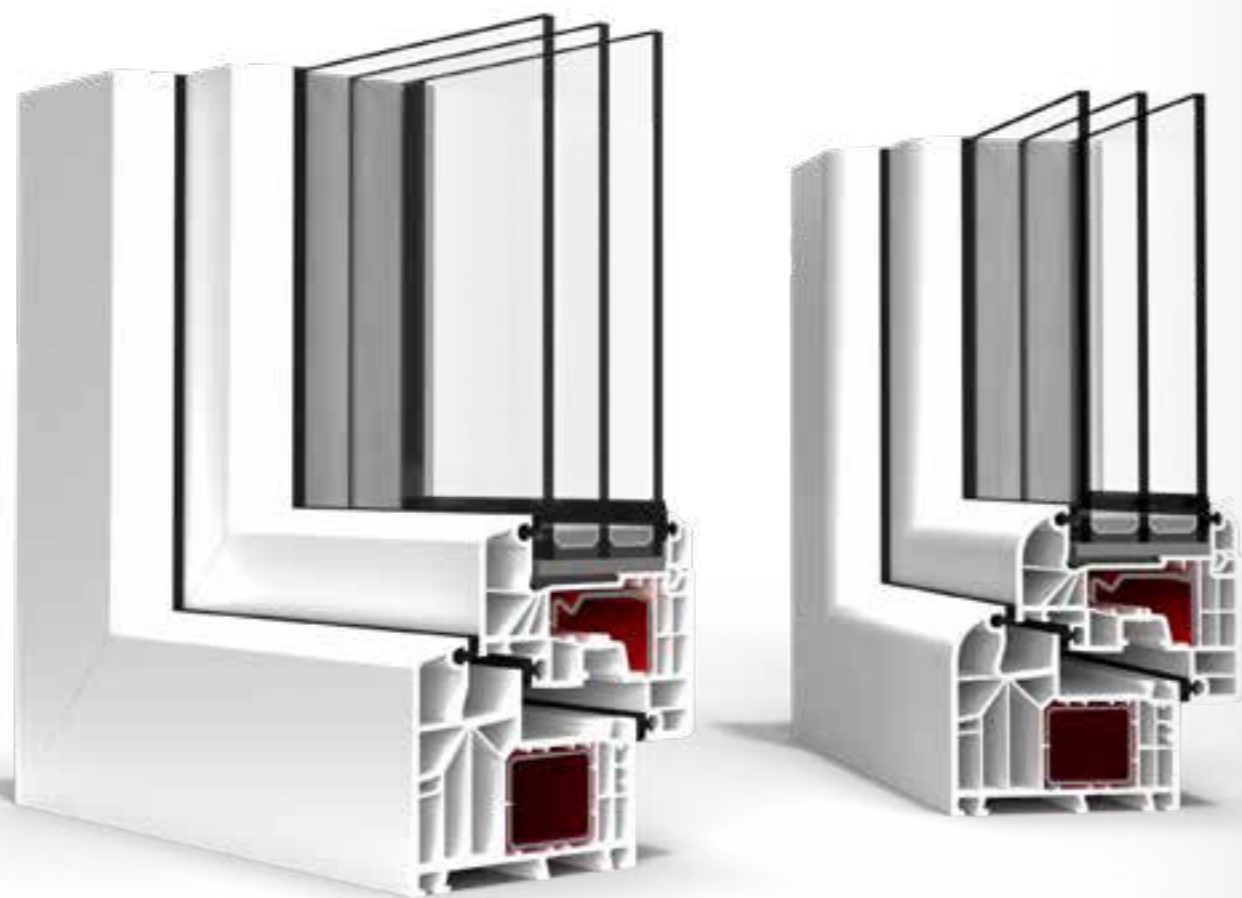

6



3

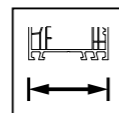

85

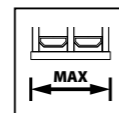

52

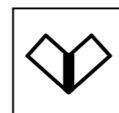

V-PERFECT TECHNOLOGY



ALU

IDEAL 4000

IDEAL 0000 NEW

IDEAL 5000

IDEAL 7000 NEW

IDEAL 8000

ENERGETO 8000

IDEAL 4000

IDEAL 0000 NEW

IDEAL 5000

IDEAL 7000 NEW

IDEAL 8000

ENERGETO 8000

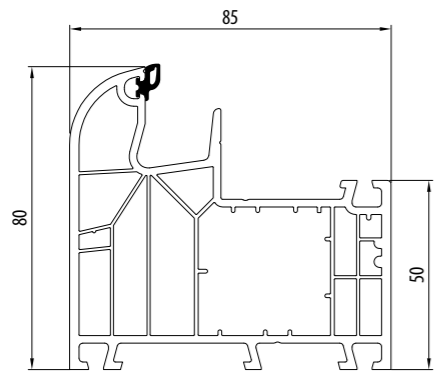

RL 180x03

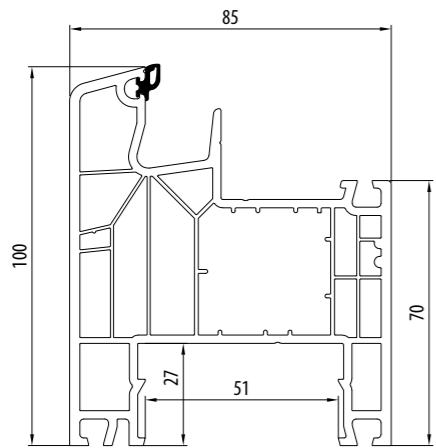

CL ALU 180x04

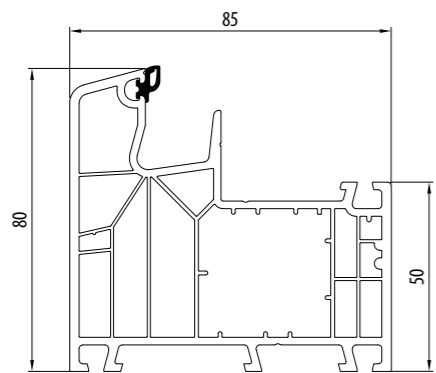

CL ALU 180x05

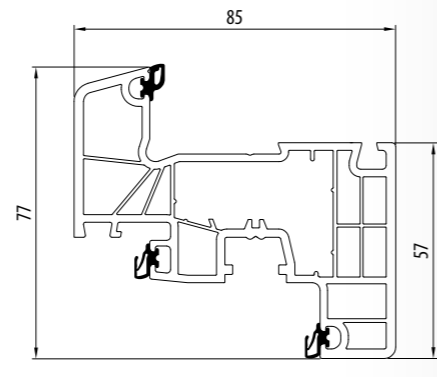

CL 180x20

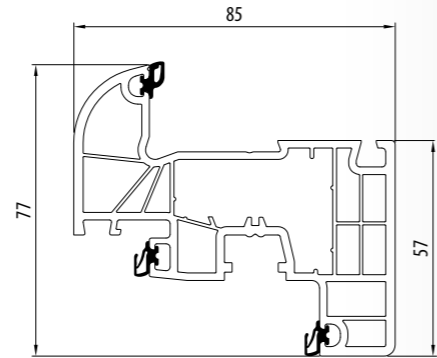

CL 180x22

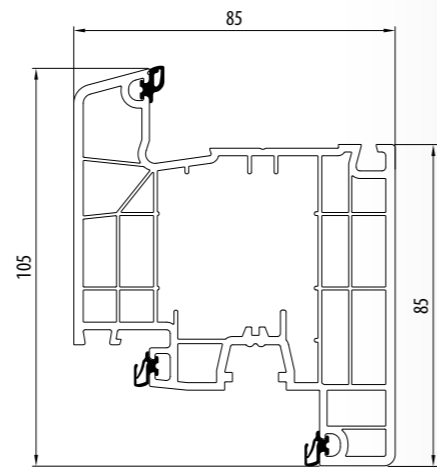

CL ALU 180x30

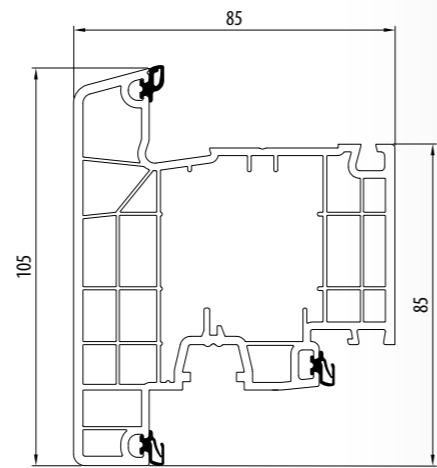

CL 180x31

1:2

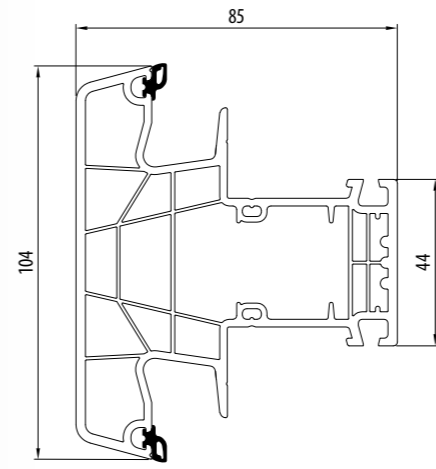

CL ALU 180x44

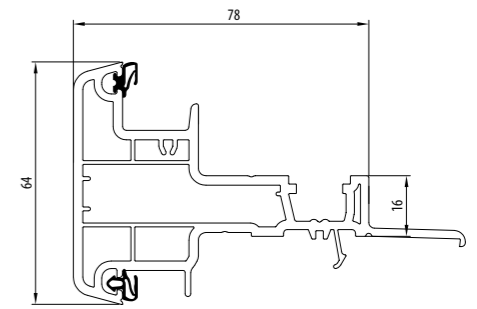

CL ALU 180x64

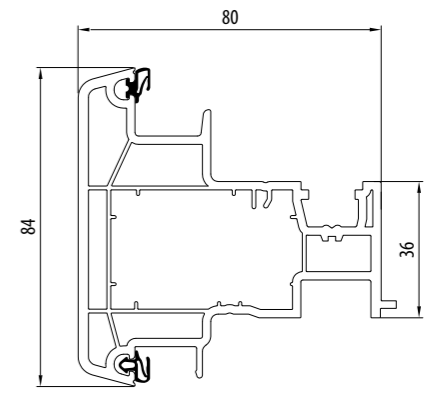

CL ALU 180x66

1:2



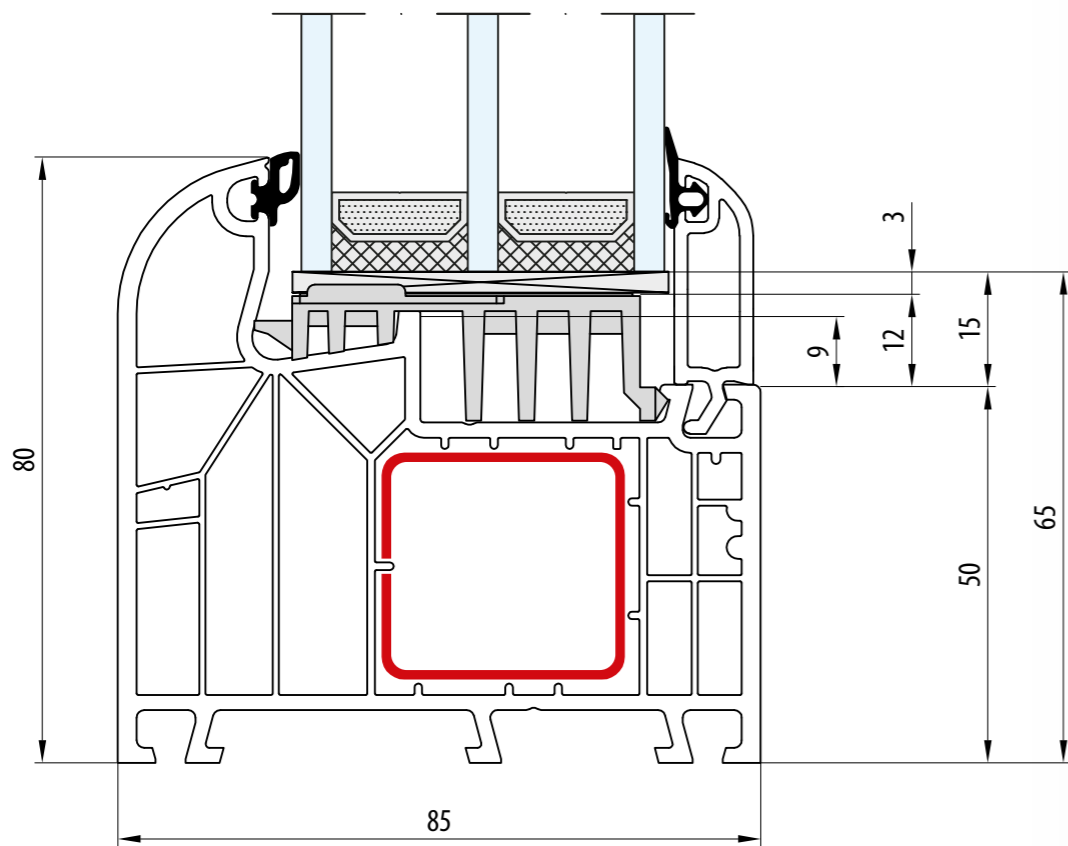
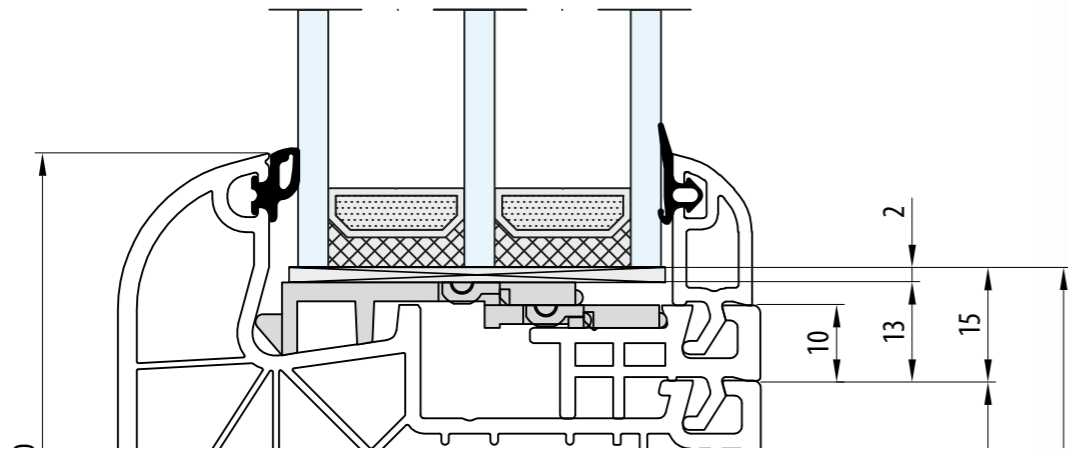

- Rama: 80 mm
- Dormant: 80 mm
- Frame: 80 mm
- Rahmen: 80 mm
- Telaio: 80 mm

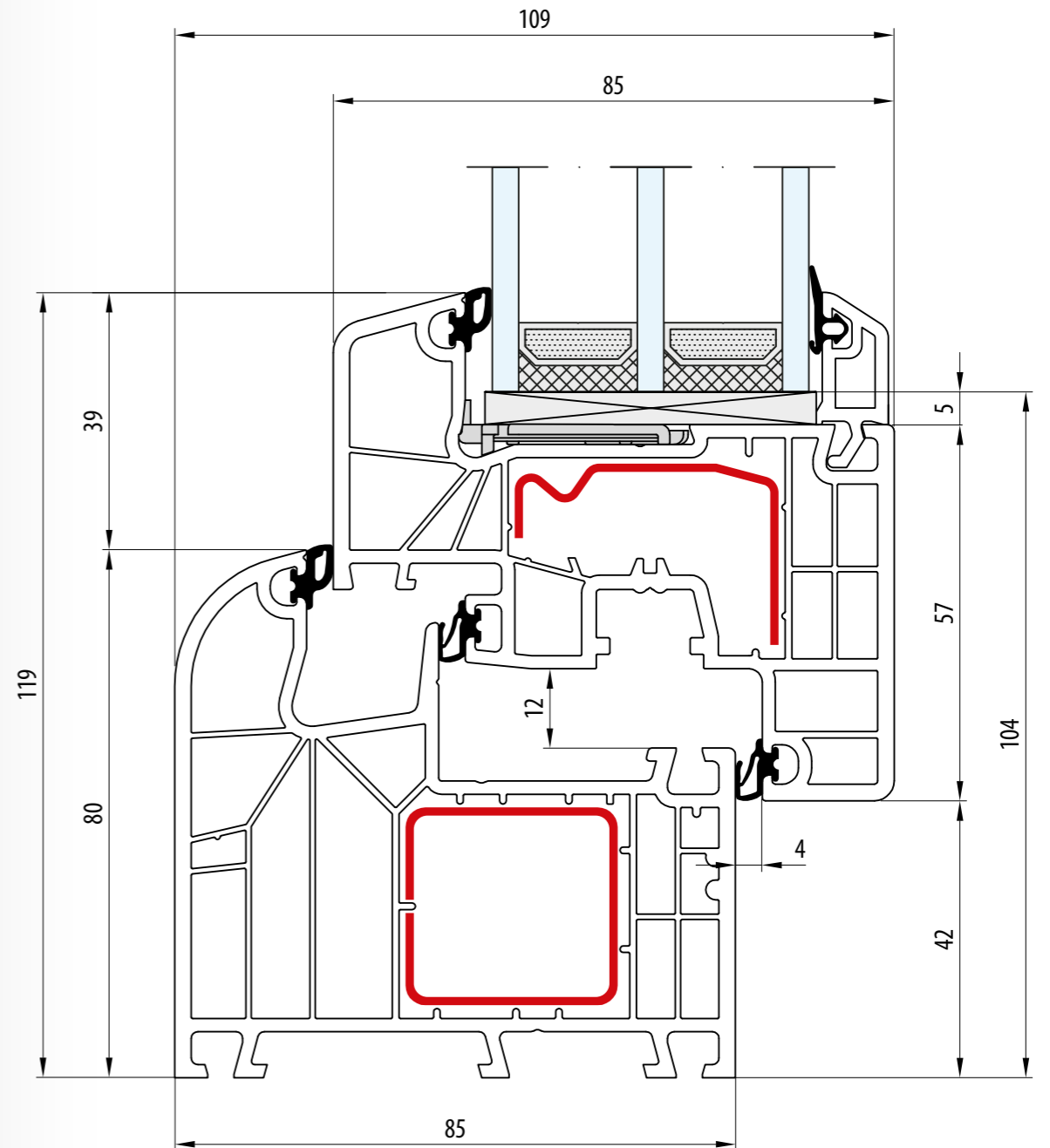
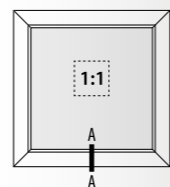

- Rama: 80 mm · Skrzydło: 77 mm
- Dormant: 80 mm · Vantail: 77 mm
- Frame: 80 mm · Sash: 77 mm
- Rahmen: 80 mm · Flügel: 77 mm
- Telaio: 80 mm · Anta: 77 mm

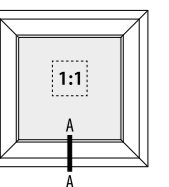

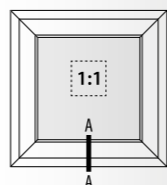
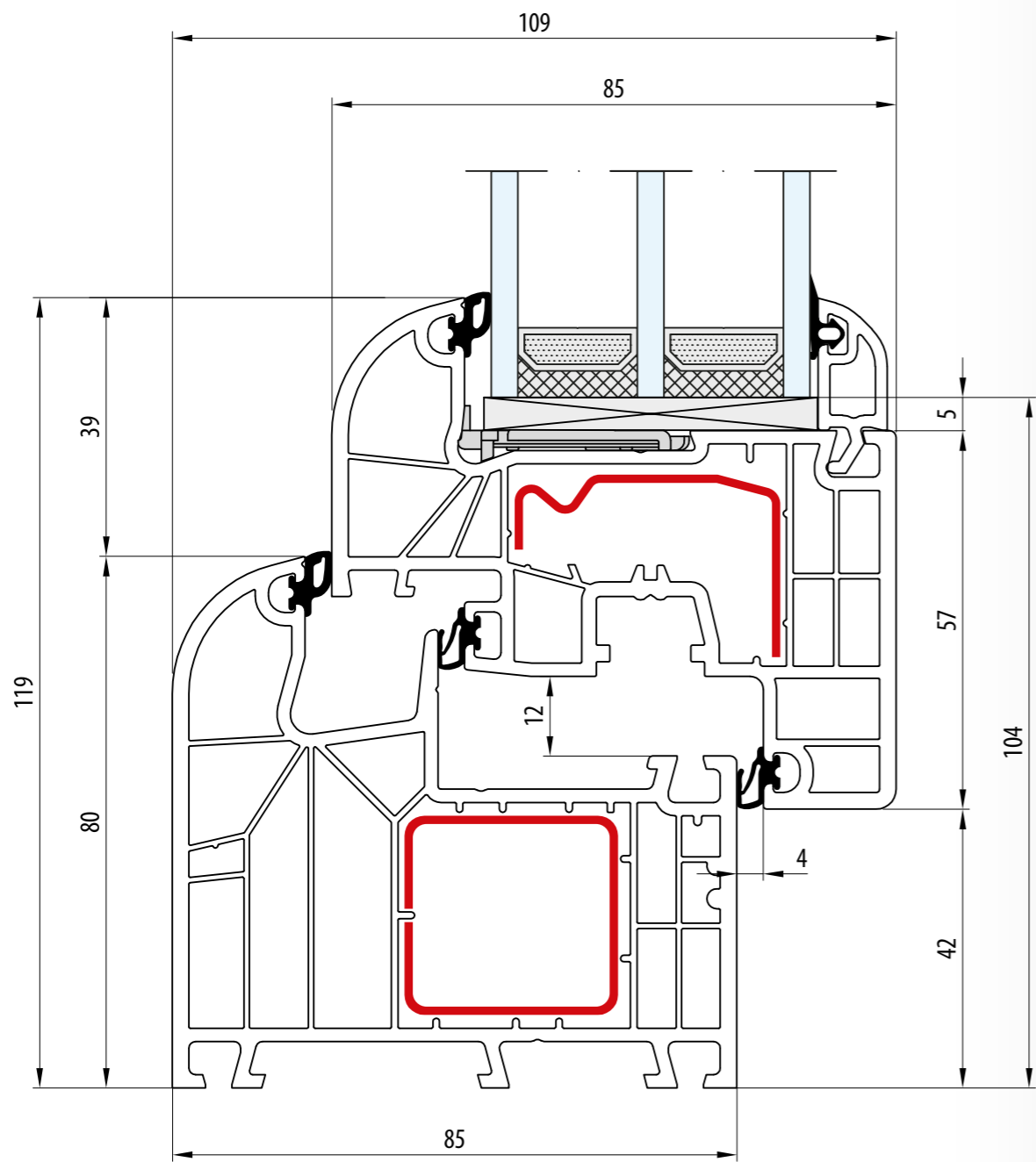

- Rama: 80 mm · Skrzydło: 77 mm
- Dormant: 80 mm · Vantail: 77 mm
- Frame: 80 mm · Sash: 77 mm
- Rahmen: 80 mm · Flügel: 77 mm
- Telaio: 80 mm · Anta: 77 mm

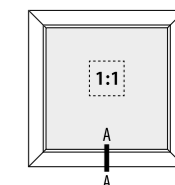
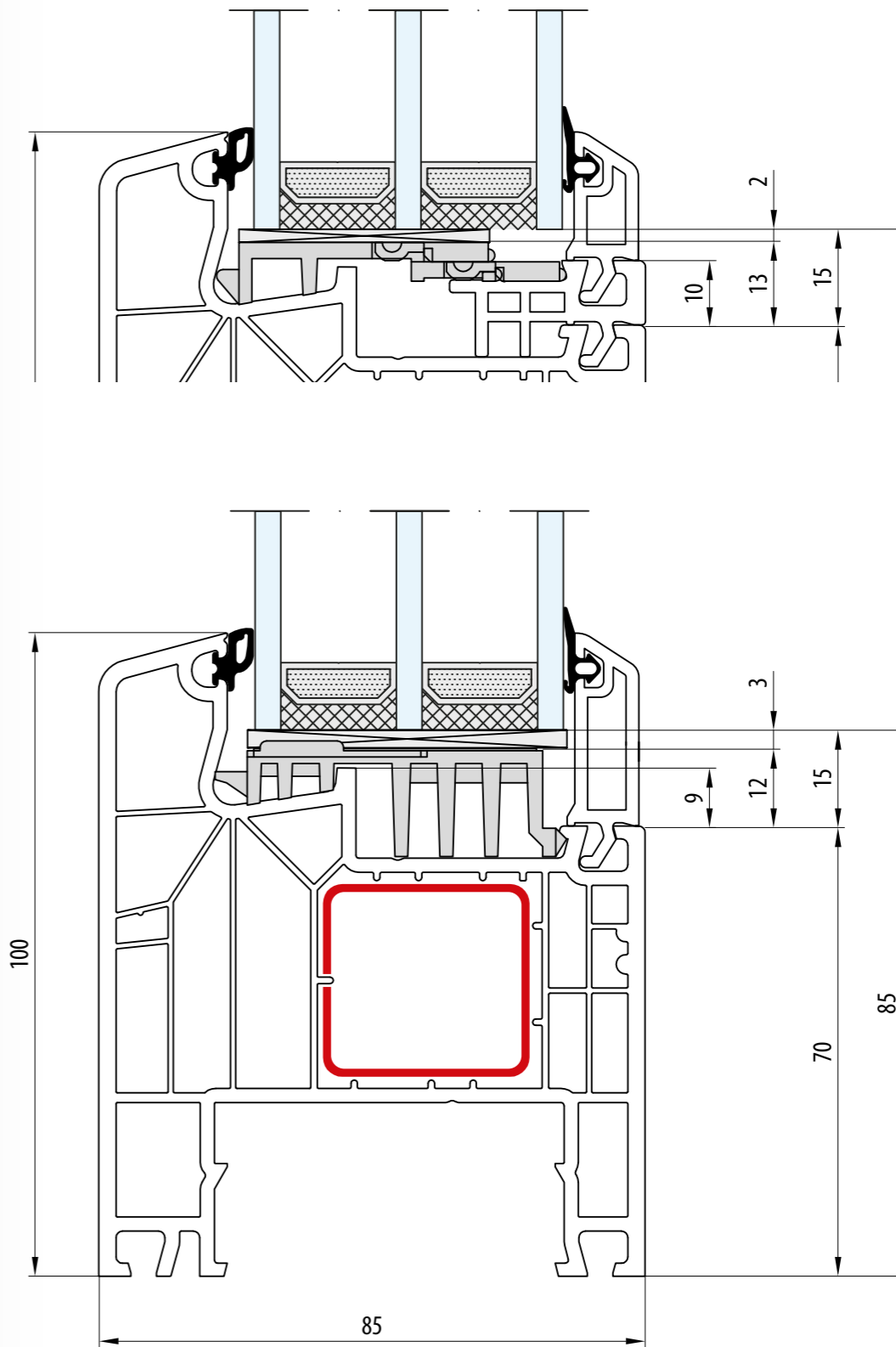

- Rama: 100 mm
- Dormant: 100 mm
- Frame: 100 mm
- Rahmen: 100 mm
- Telaio: 100 mm

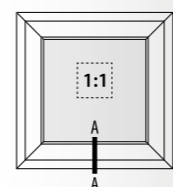
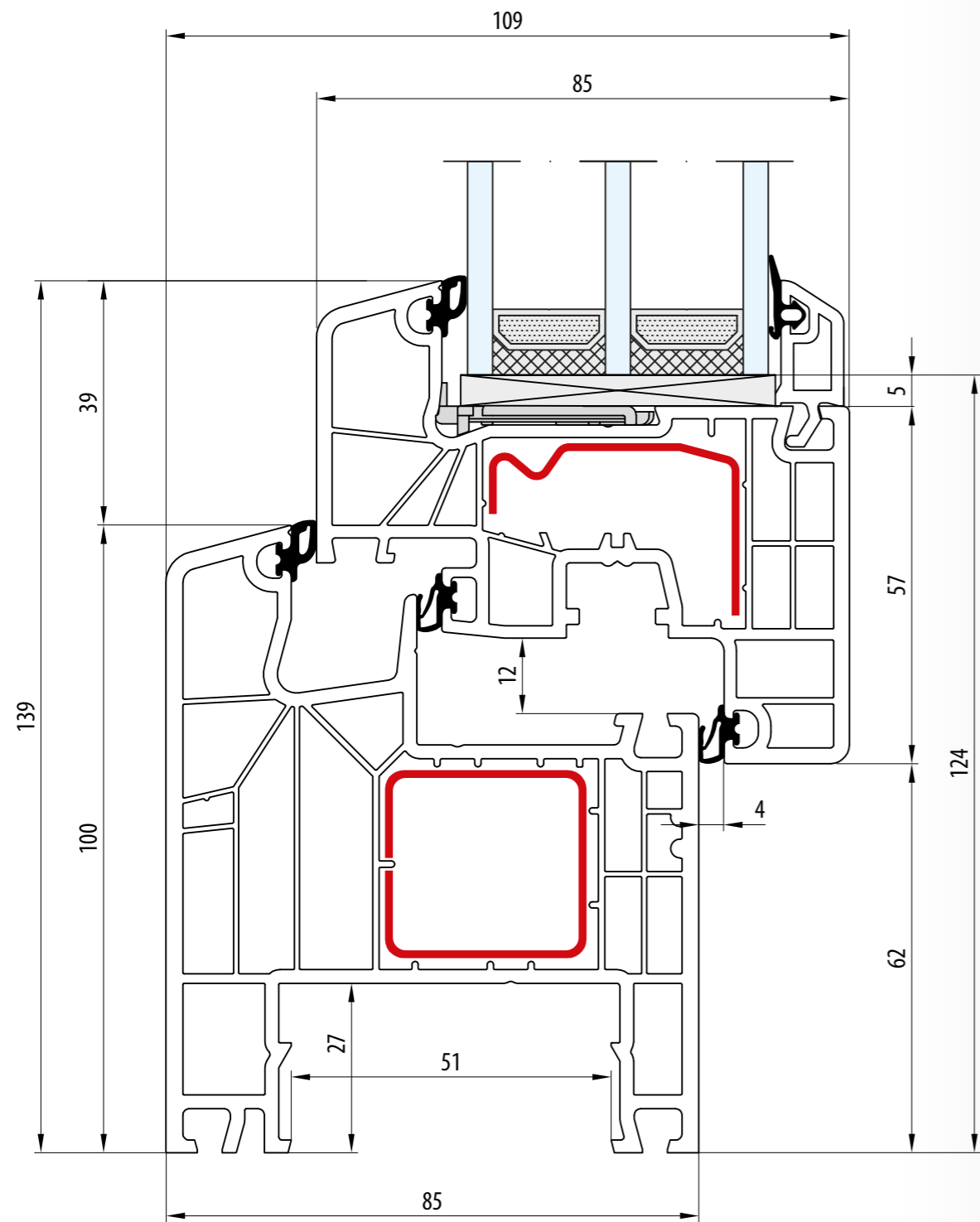

- Rama: 100 mm · Skrzydło: 77 mm
- Dormant: 100 mm · Vantail: 77 mm
- Frame: 100 mm · Sash: 77 mm
- Rahmen: 100 mm · Flügel: 77 mm
- Telaio: 100 mm · Anta: 77 mm

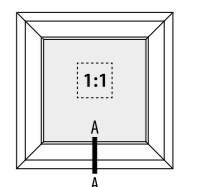
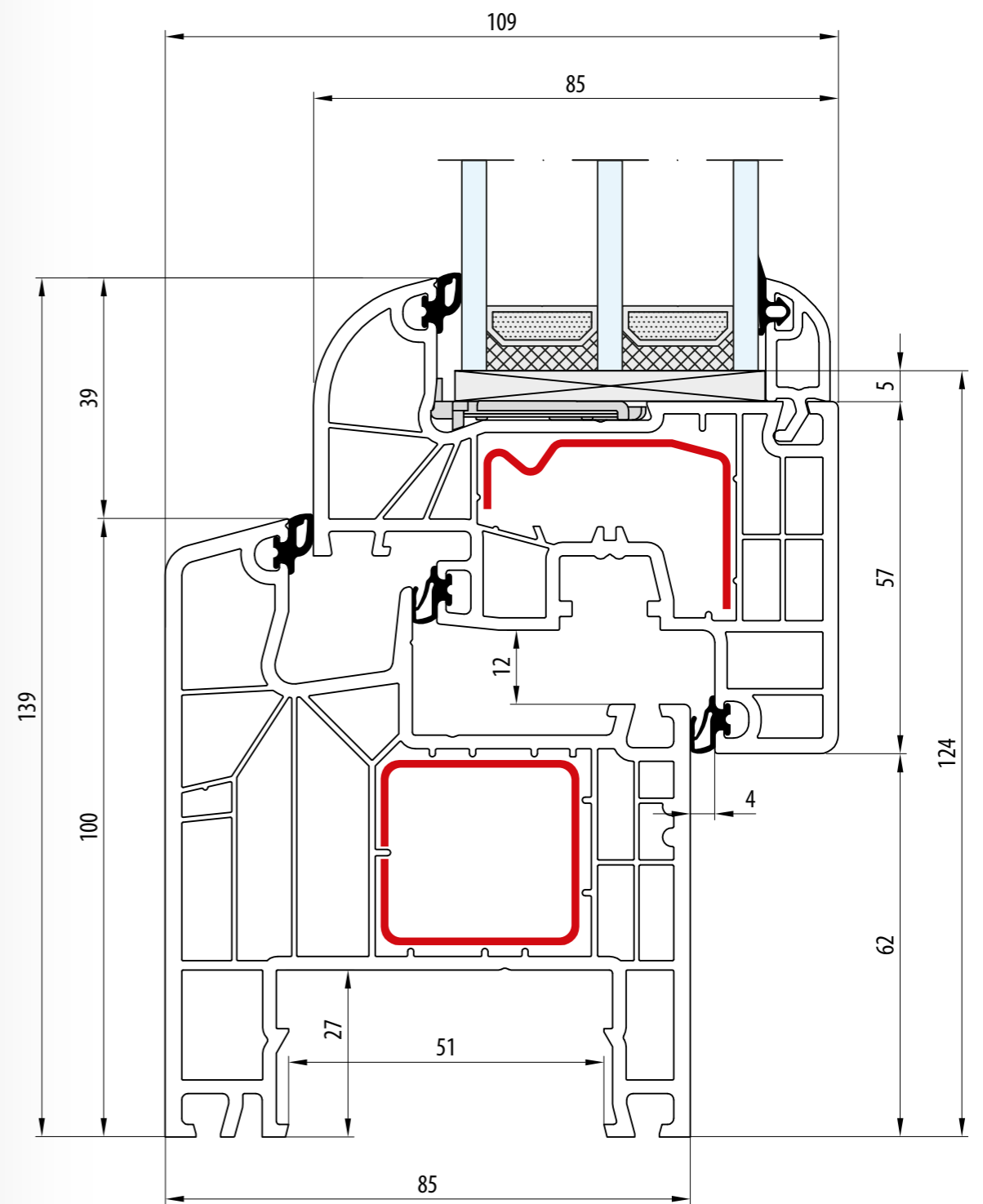

- Rama: 100 mm · Skrzydło: 77 mm
- Dormant: 100 mm · Vantail: 77 mm
- Frame: 100 mm · Sash: 77 mm
- Rahmen: 100 mm · Flügel: 77 mm
- Telaio: 100 mm · Anta: 77 mm

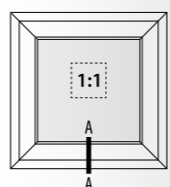
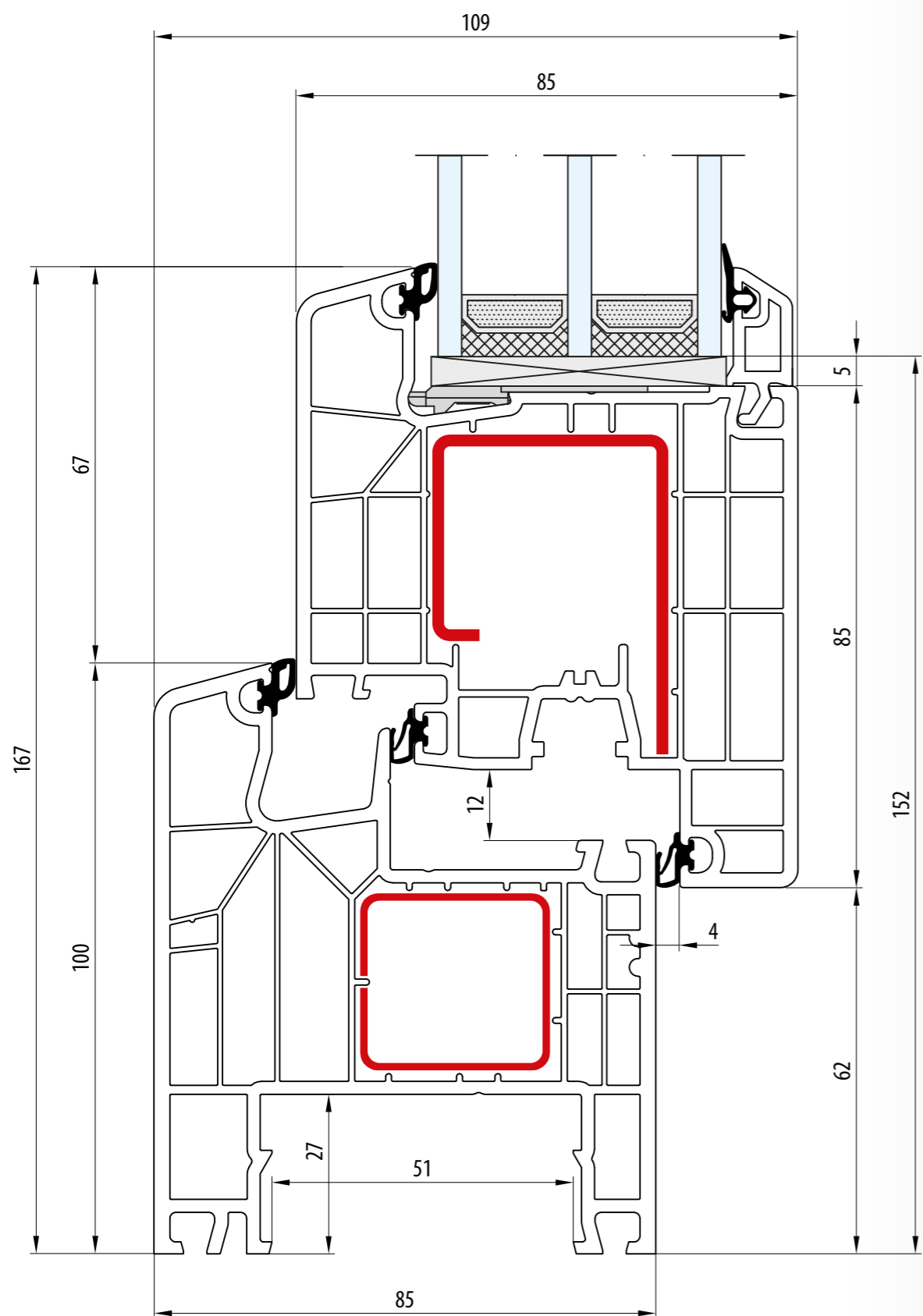

- Rama: 100 mm - Skrzydło: 105 mm
- Dormant: 100 mm - Vantail: 105 mm
- Frame: 100 mm - Sash: 105 mm
- Rahmen: 100 mm - Flügel: 105 mm
- Telaio: 100 mm - Anta: 105 mm

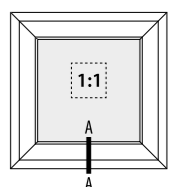
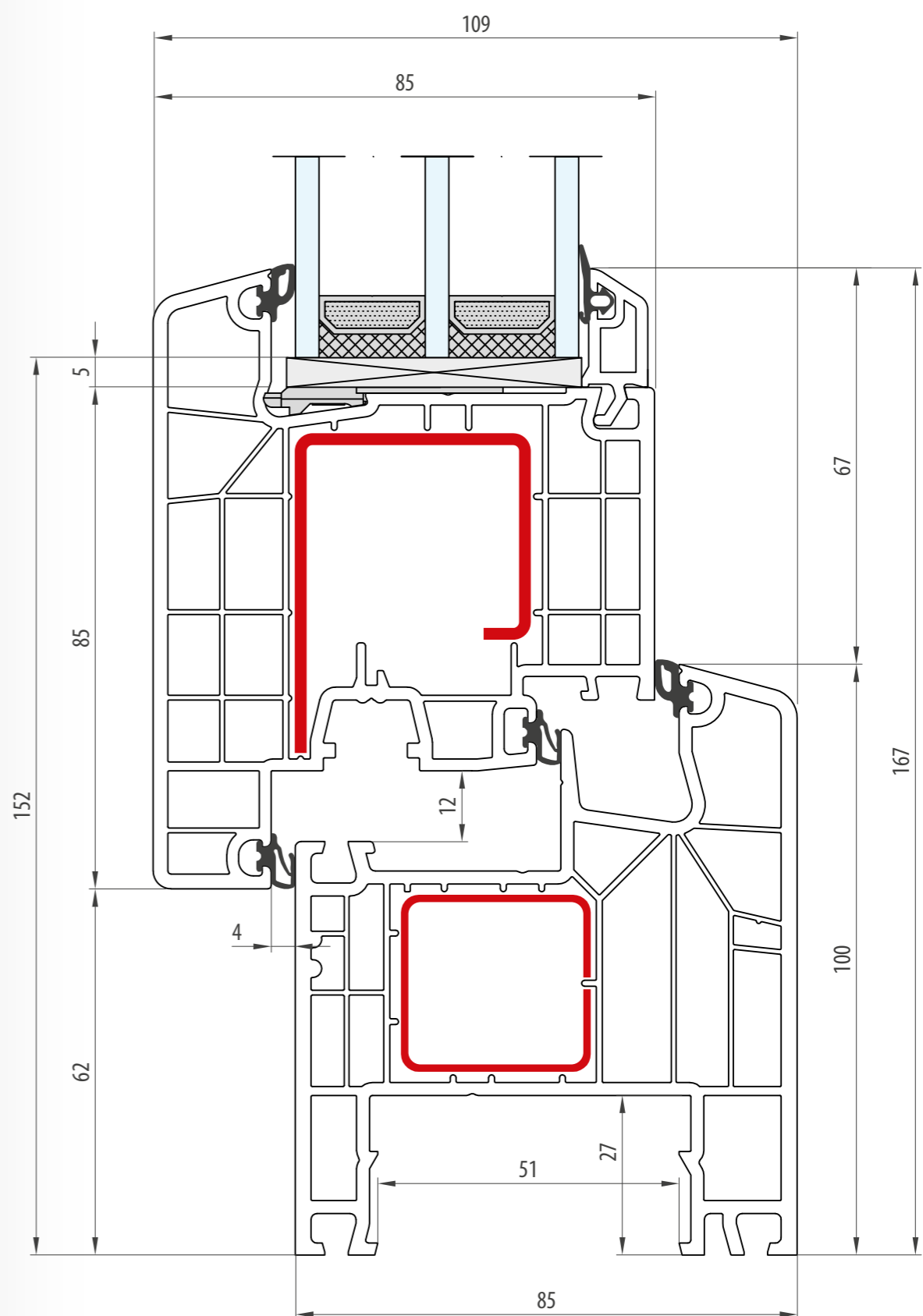

- Rama: 100 mm - Skrzydło: 105 mm
- Dormant: 100 mm - Vantail: 105 mm
- Frame: 100 mm - Sash: 105 mm
- Rahmen: 100 mm - Flügel: 105 mm
- Telaio: 100 mm - Anta: 105 mm

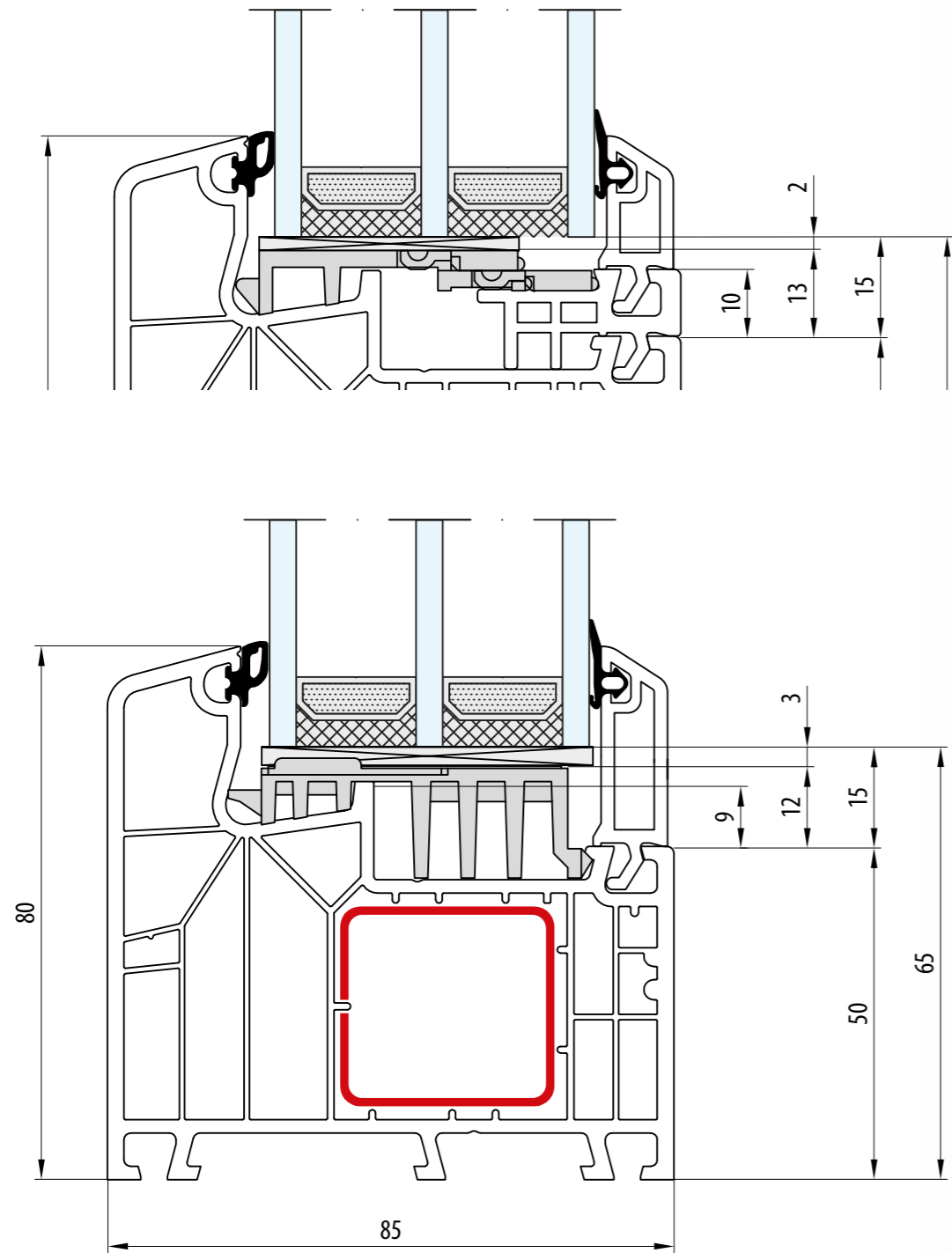

- Rama: 80 mm
- Dormant: 80 mm
- Frame: 80 mm
- Rahmen: 80 mm
- Telaio: 80 mm

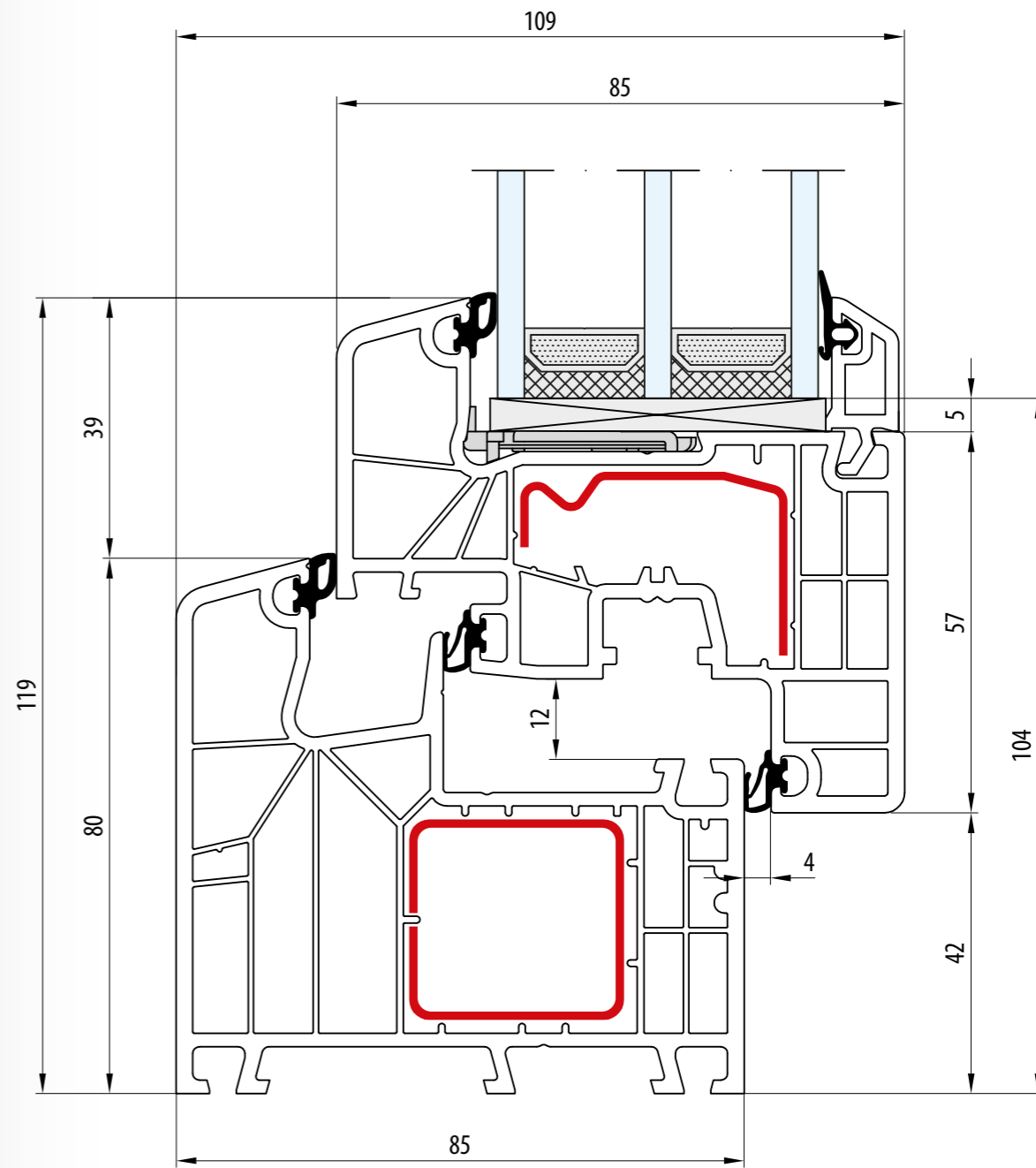
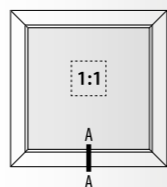

- Rama: 80 mm · Skrzydło: 77 mm
- Dormant: 80 mm · Vantail: 77 mm
- Frame: 80 mm · Sash: 77 mm
- Rahmen: 80 mm · Flügel: 77 mm
- Telaio: 80 mm · Anta: 77 mm

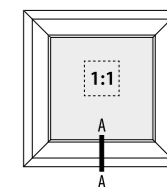

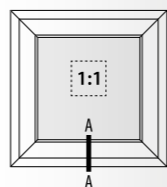
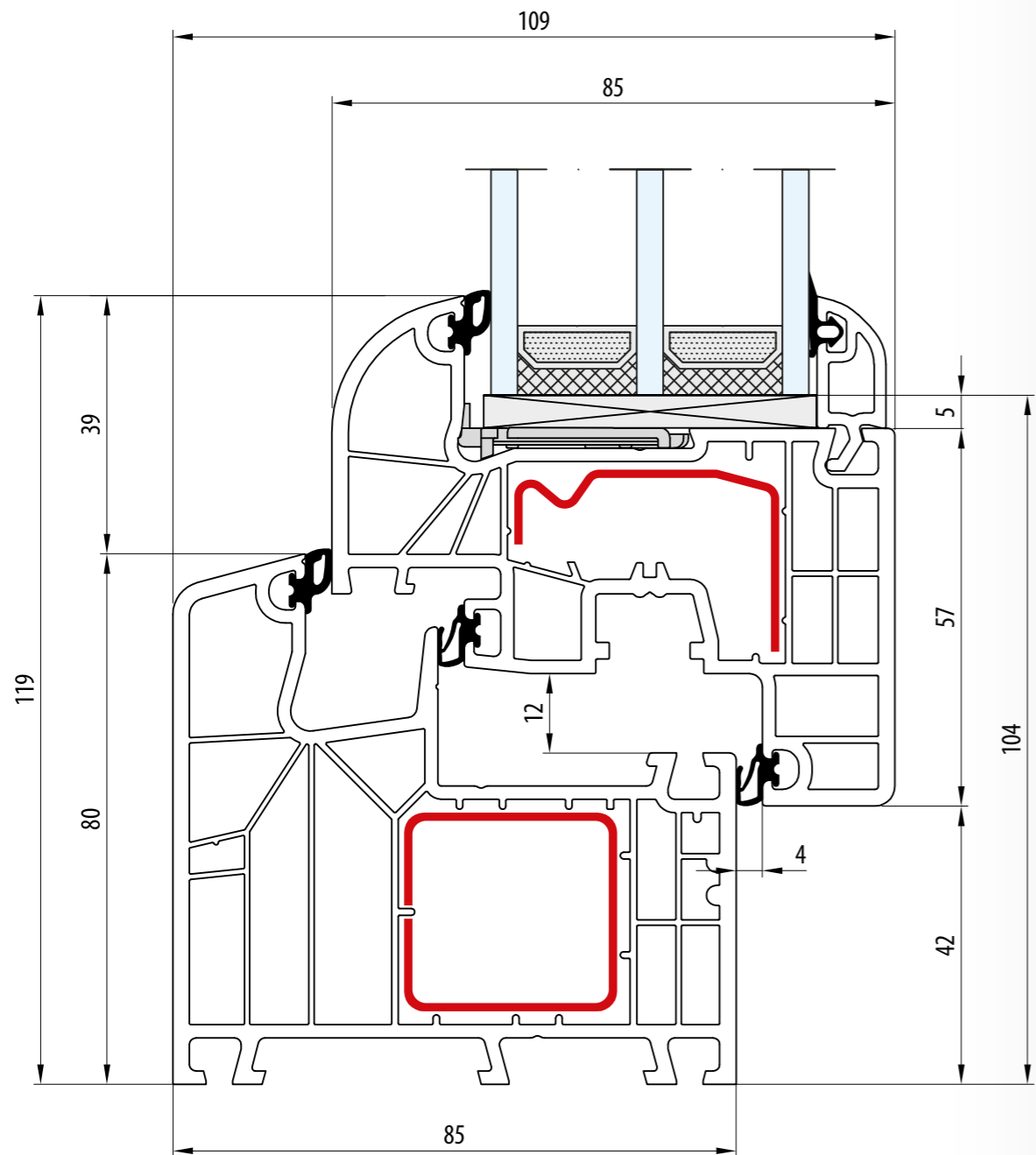

- Rama: 80 mm · Skrzydło: 77 mm
- Dormant: 80 mm · Vantail: 77 mm
- Frame: 80 mm · Sash: 77 mm
- Rahmen: 80 mm · Flügel: 77 mm
- Telaio: 80 mm · Anta: 77 mm

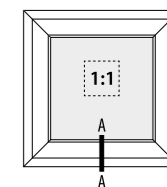
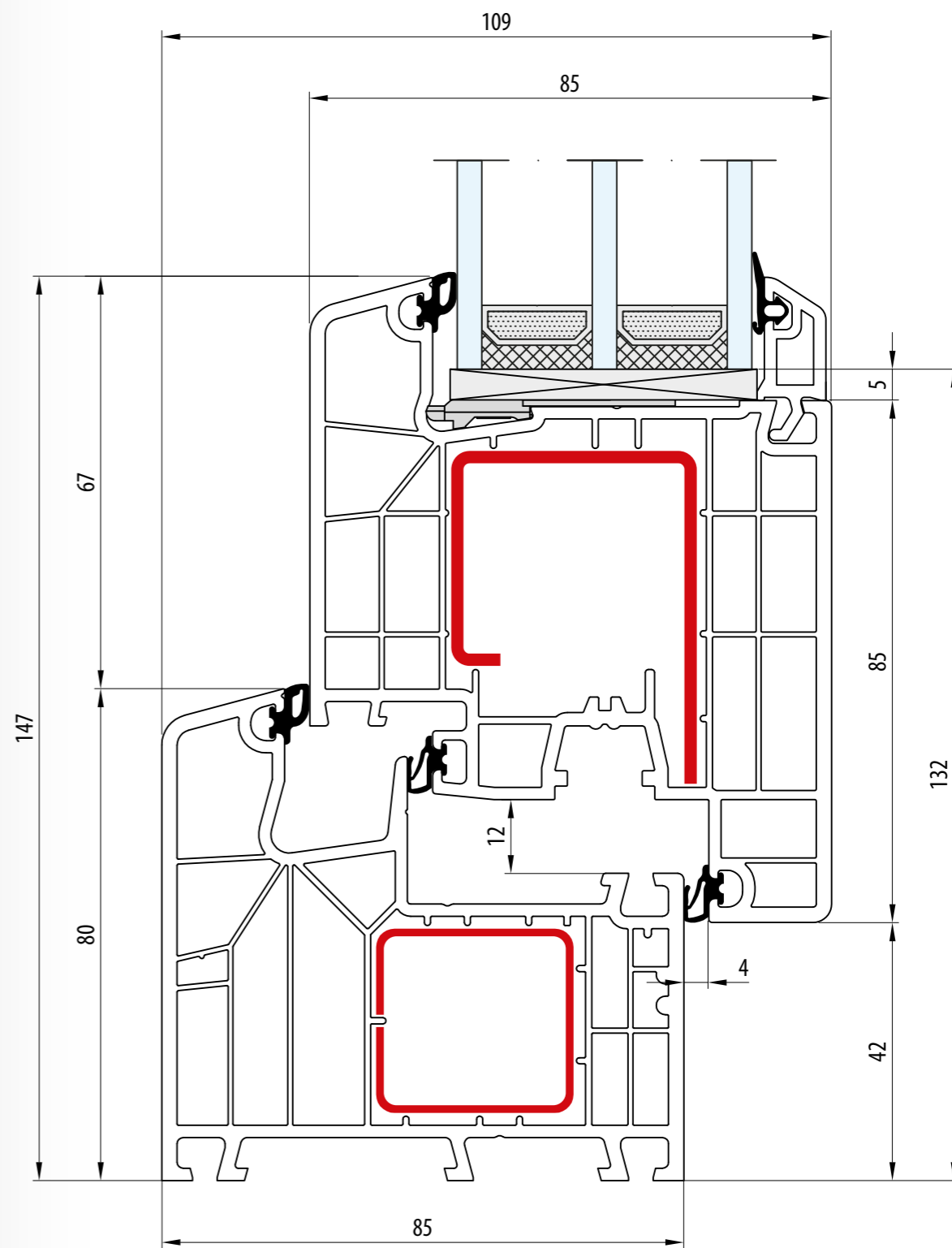

- Rama: 80 mm · Skrzydło: 105 mm
- Dormant: 80 mm · Vantail: 105 mm
- Frame: 80 mm · Sash: 105 mm
- Rahmen: 80 mm · Flügel: 105 mm
- Telaio: 80 mm · Anta: 105 mm

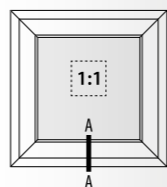
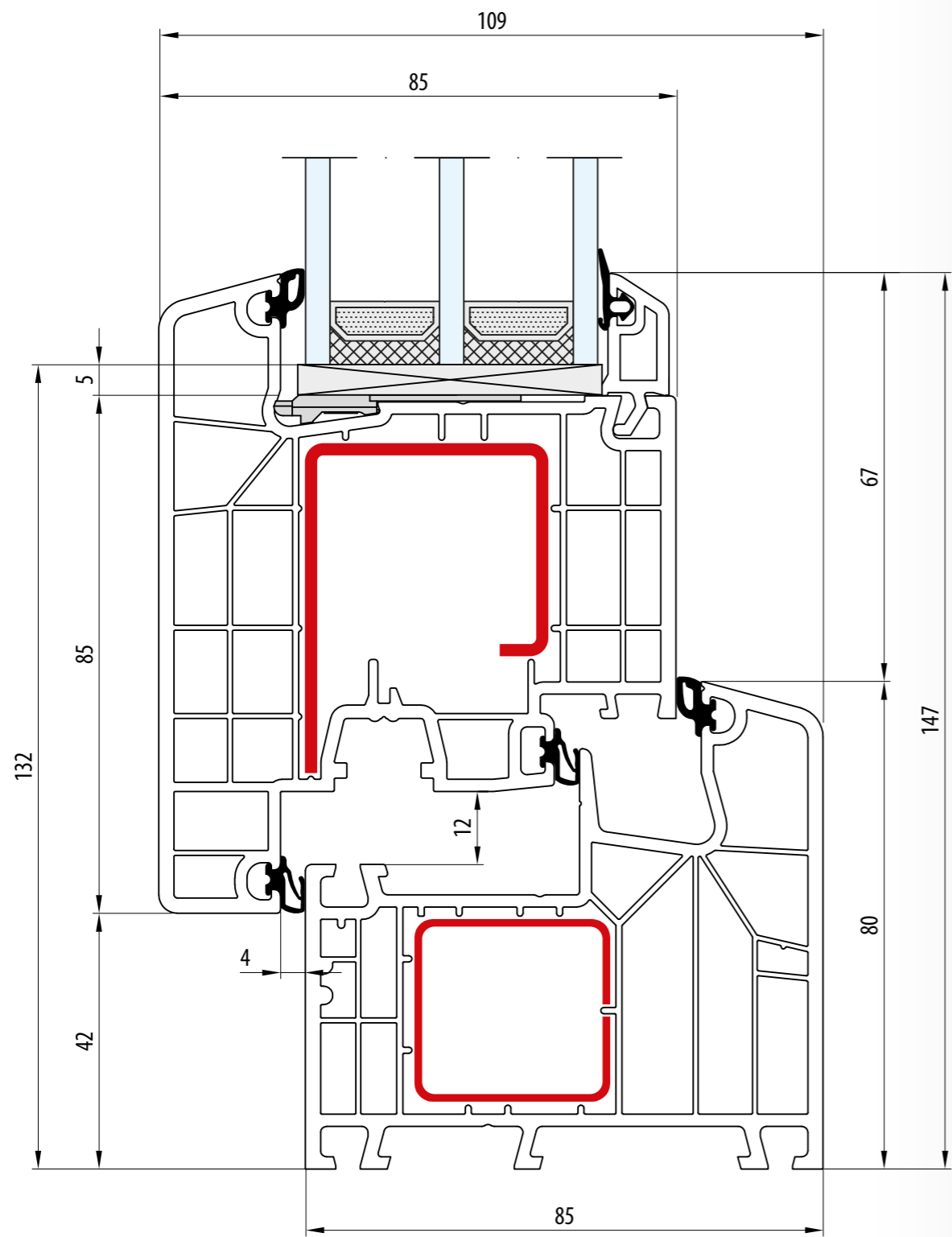

- Rama: 80 mm · Skrzydło: 105 mm
- Dormant: 80 mm · Vantail: 105 mm
- Frame: 80 mm · Sash: 105 mm
- Rahmen: 80 mm · Flügel: 105 mm
- Telaio: 80 mm · Anta: 105 mm

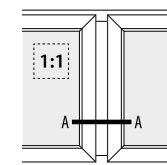
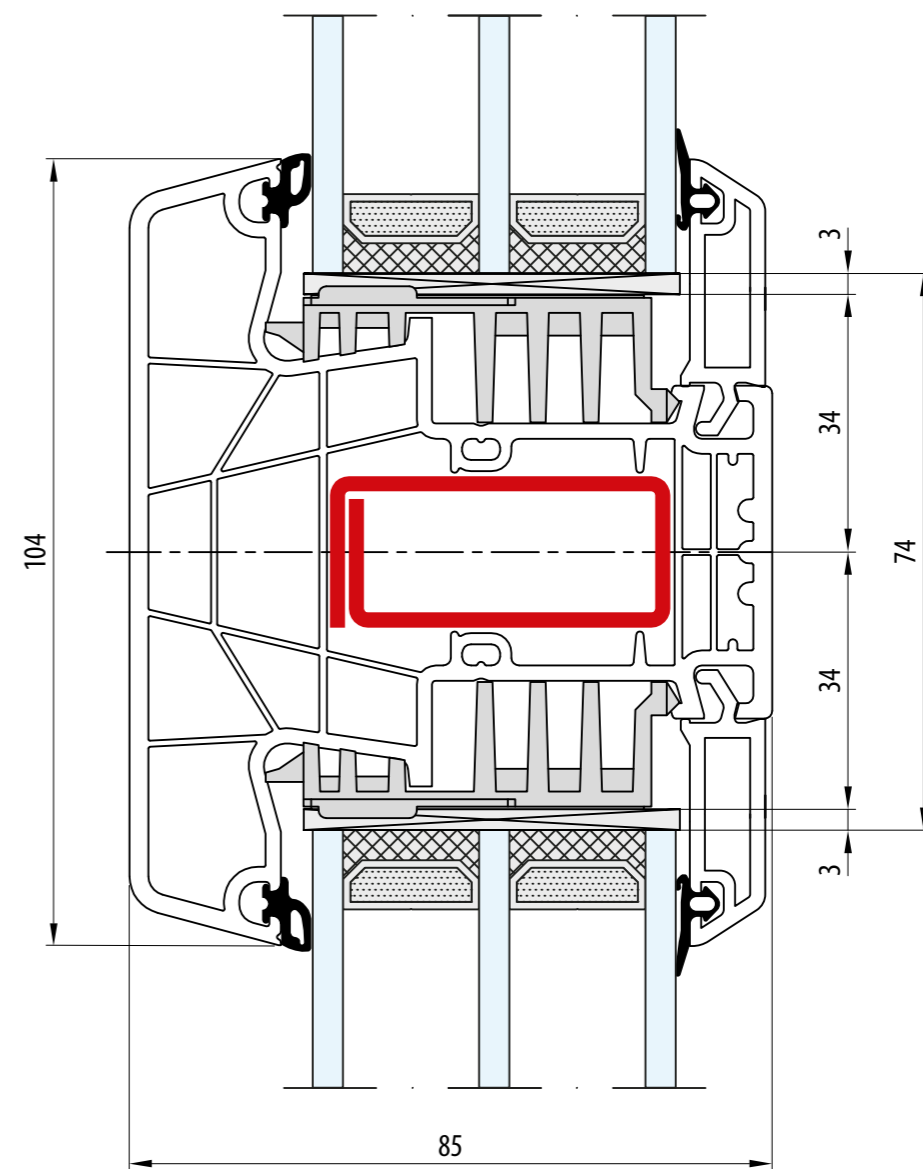

- Słupek stalowy: 104 mm
- Meneau fixe: 104 mm
- Fix post: 104 mm
- Festem Pfahl: 104 mm
- Montante fisso: 104 mm

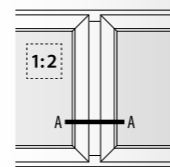
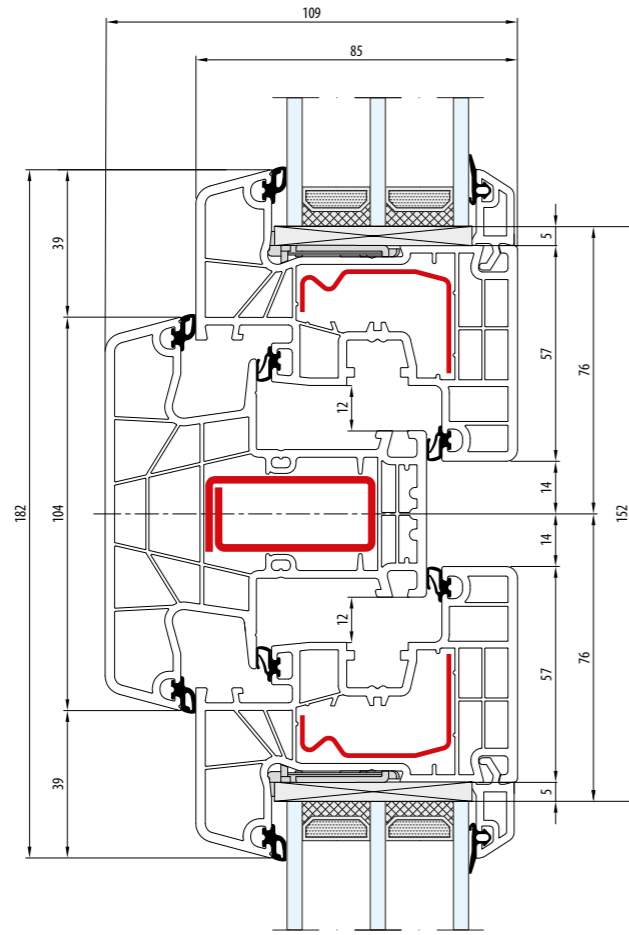

- Słupek stały: 104 mm · Skrzydło: 77 mm
- Meneau fixe: 104 mm · Vantail: 77 mm
- Fix post: 104 mm · Sash: 77 mm
- Festem Pfahl: 104 mm · Flügel: 77 mm
- Montante fisso: 104 mm · Anta: 77 mm

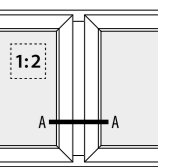
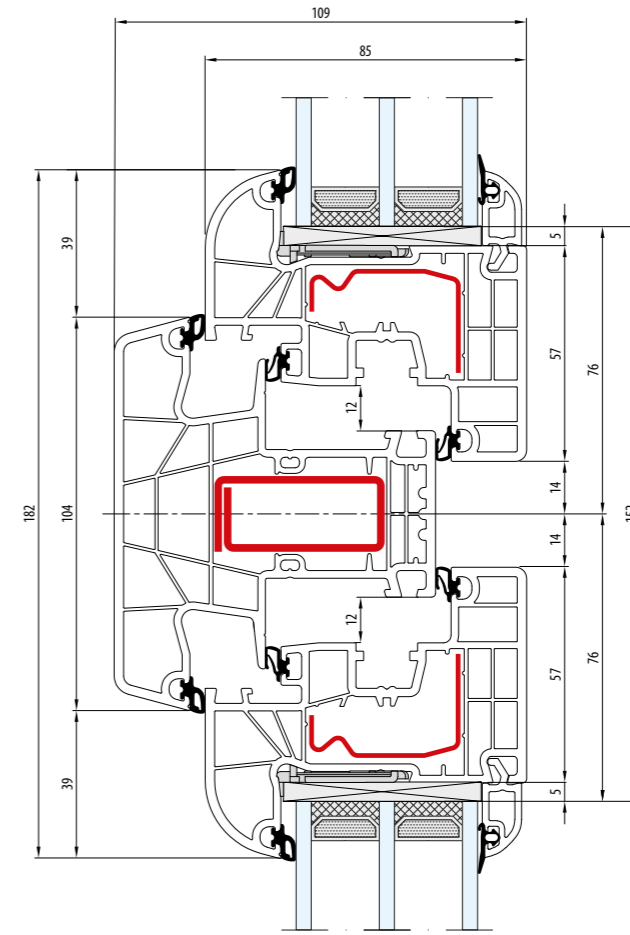

- Słupek stały: 104 mm · Skrzydło: 77 mm
- Meneau fixe: 104 mm · Vantail: 77 mm
- Fix post: 104 mm · Sash: 77 mm
- Festem Pfahl: 104 mm · Flügel: 77 mm
- Montante fisso: 104 mm · Anta: 77 mm

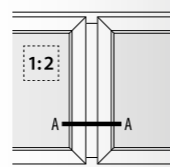
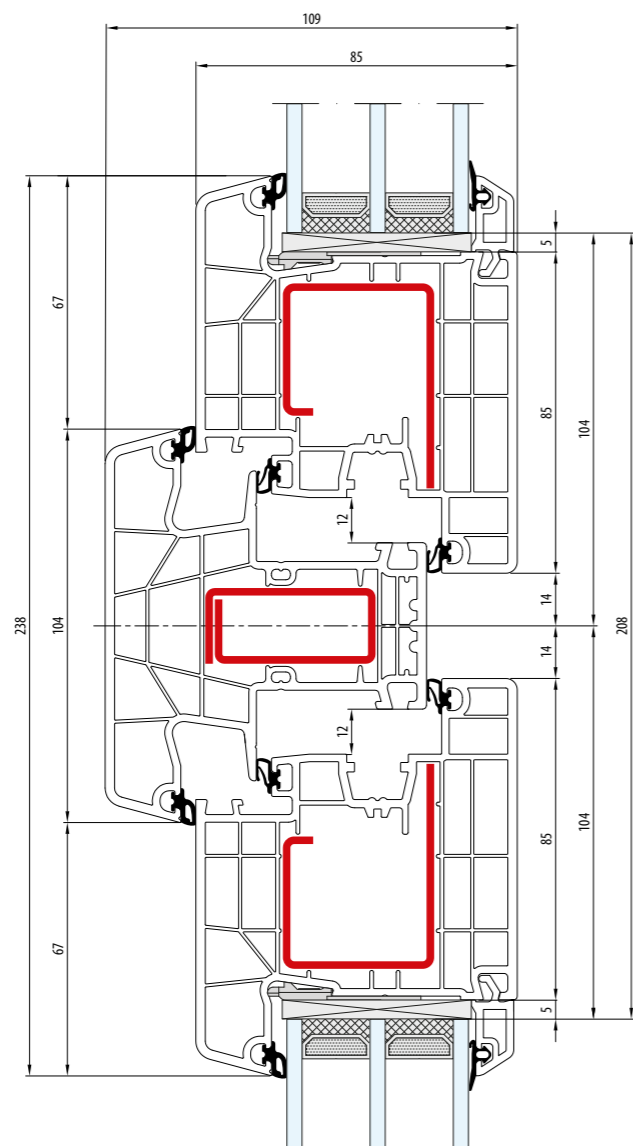



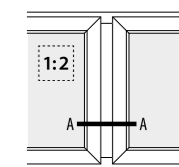
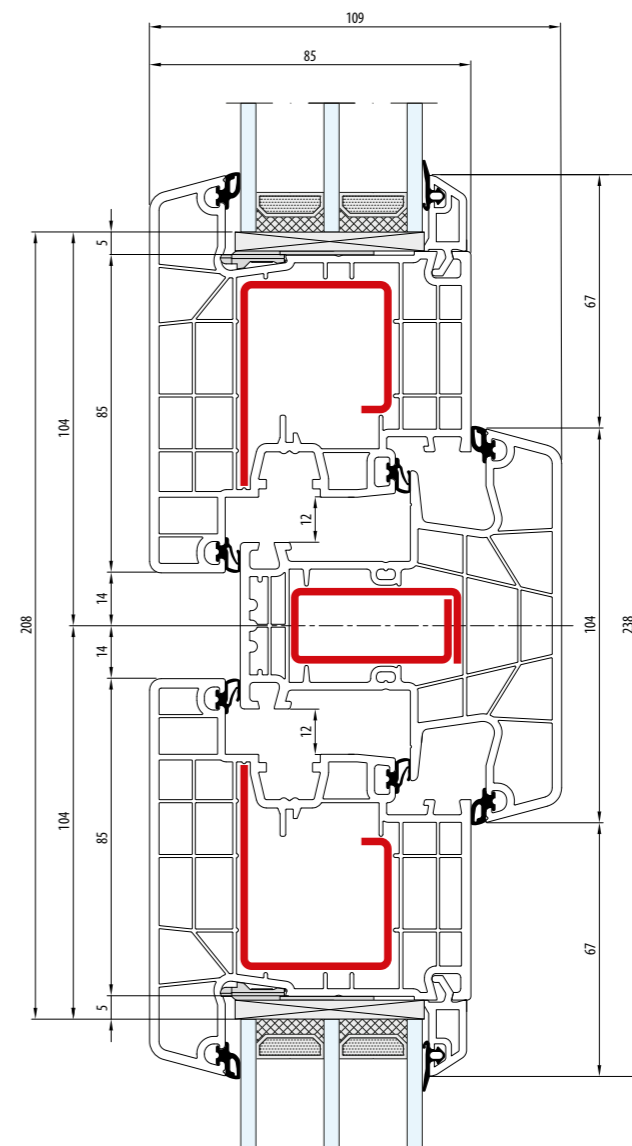

- Słupek stały: 104 mm · Skrzydło: 105 mm
- Meneau fixe: 104 mm · Vantail: 105 mm
- Fix post: 104 mm · Sash: 105 mm
- Festem Pfahl: 104 mm · Flügel: 105 mm
- Montante fisso: 104 mm · Anta: 105 mm

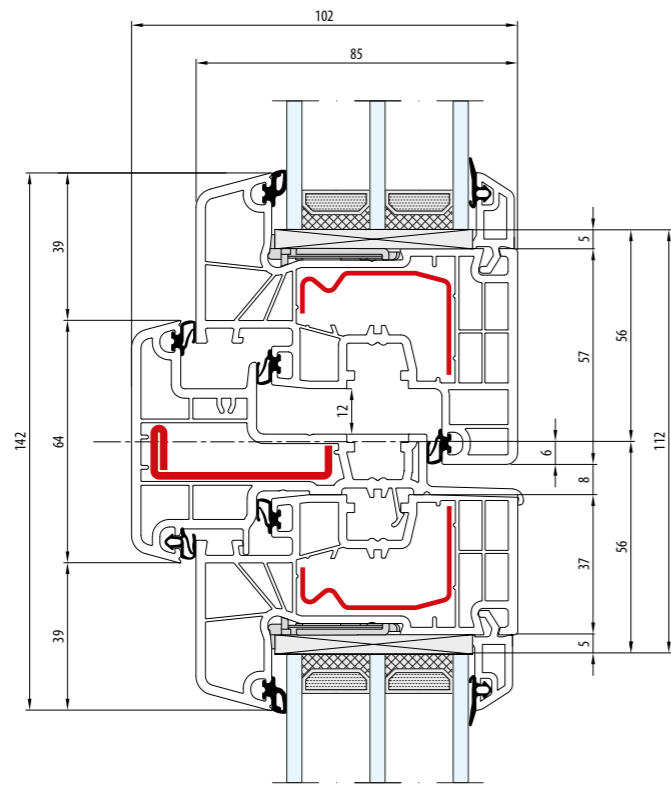





- Słupek stały: 104 mm · Skrzydło: 105 mm
- Meneau fixe: 104 mm · Vantail: 105 mm
- Fix post: 104 mm · Sash: 105 mm
- Festem Pfahl: 104 mm · Flügel: 105 mm
- Montante fisso: 104 mm · Anta: 105 mm

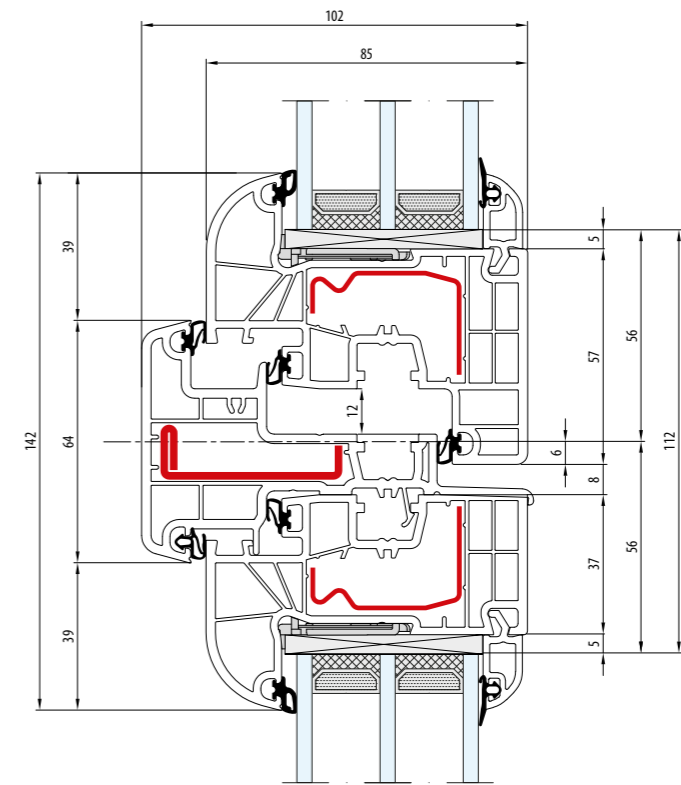
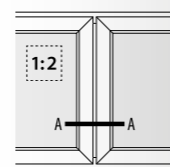

-  Słupek ruchomy: 64 mm · Skrzydło: 77 mm / 57 mm
-  Meneau mobile: 64 mm · Vantail: 77 mm / 57 mm
-  Movable post: 64 mm · Sash: 77 mm / 57 mm
-  Stulp: 64 mm · Flügel: 77 mm / 57 mm
-  Montante mobile: 64 mm · Anta: 77 mm / 57 mm



-  Słupek ruchomy: 64 mm · Skrzydło: 77 mm / 57 mm
-  Meneau mobile: 64 mm · Vantail: 77 mm / 57 mm
-  Movable post: 64 mm · Sash: 77 mm / 57 mm
-  Stulp: 64 mm · Flügel: 77 mm / 57 mm
-  Montante mobile: 64 mm · Anta: 77 mm / 57 mm

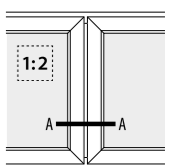

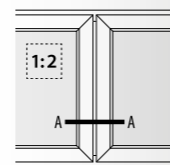
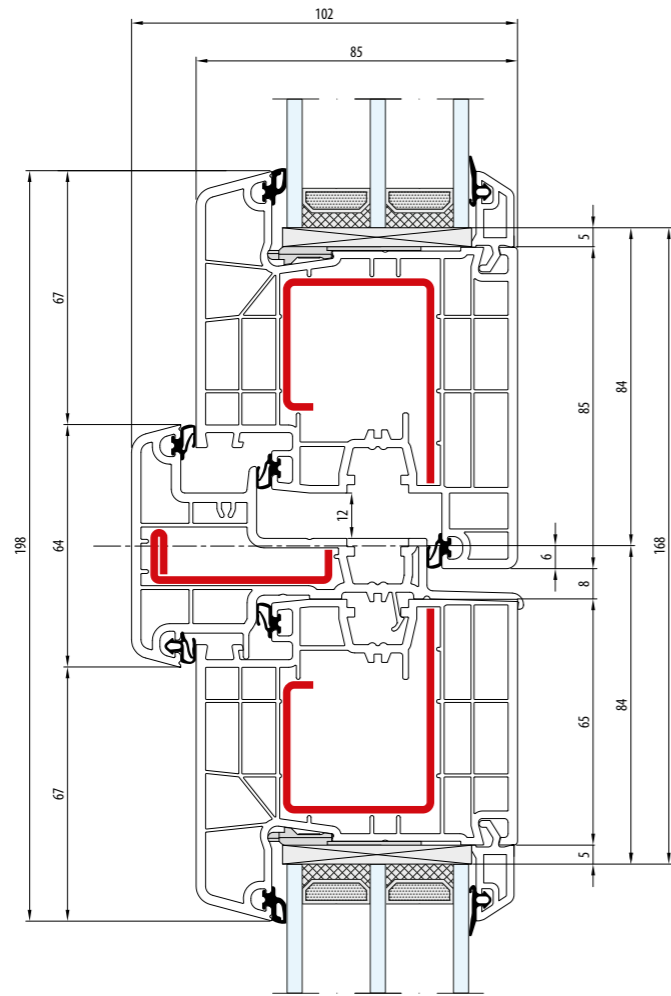

- Słupek ruchomy: 64 mm · Skrzydło: 105 mm / 85 mm
- Meneau mobile: 64 mm · Vantail: 105 mm / 85 mm
- Movable post: 64 mm · Sash: 105 mm / 85 mm
- Stulp: 64 mm · Flügel: 105 mm / 85 mm
- Montante mobile: 64 mm · Anta: 105 mm / 85 mm

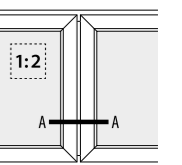
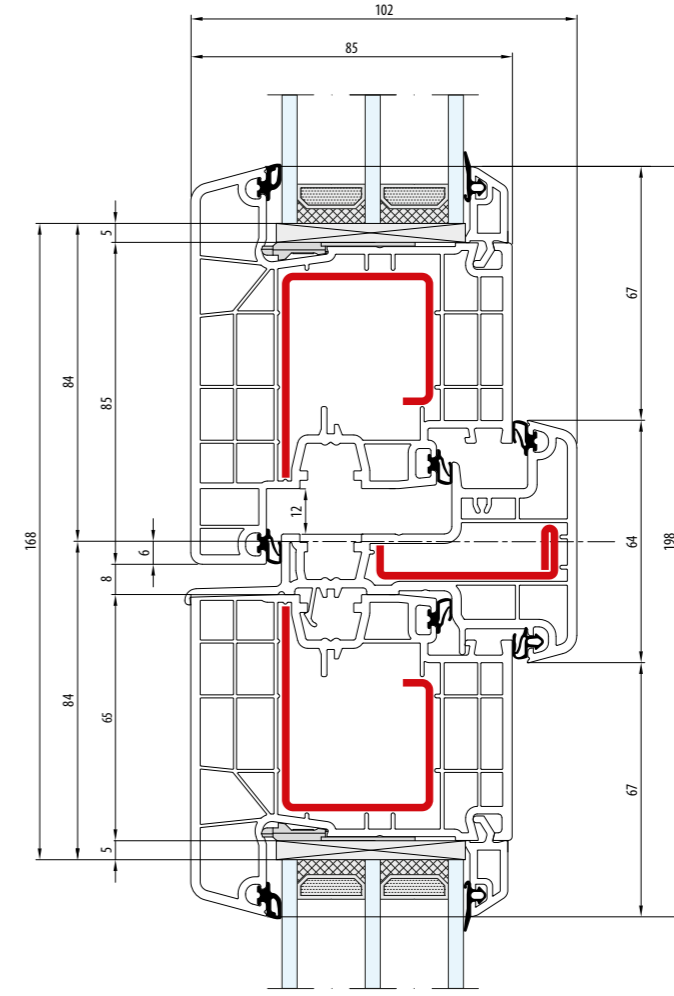

- Słupek ruchomy: 64 mm · Skrzydło: 105 mm / 85 mm
- Meneau mobile: 64 mm · Vantail: 105 mm / 85 mm
- Movable post: 64 mm · Sash: 105 mm / 85 mm
- Stulp: 64 mm · Flügel: 105 mm / 85 mm
- Montante mobile: 64 mm · Anta: 105 mm / 85 mm

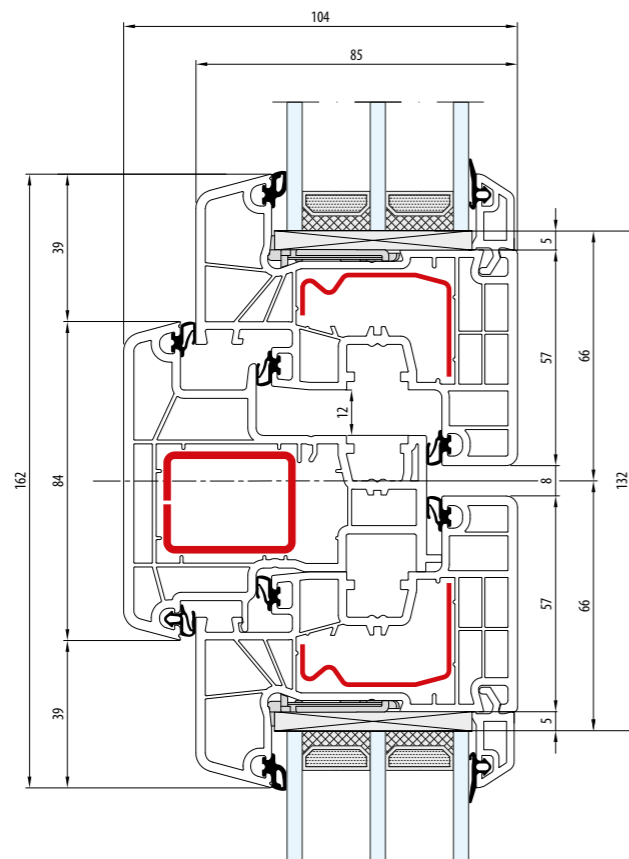

- Słupek ruchomy: 84 mm · Skrzydło: 77 mm
- Meneau mobile: 84 mm · Vantail: 77 mm
- Movable post: 84 mm · Sash: 77 mm
- Stulp: 84 mm · Flügel: 77 mm
- Montante mobile: 84 mm · Anta: 77 mm

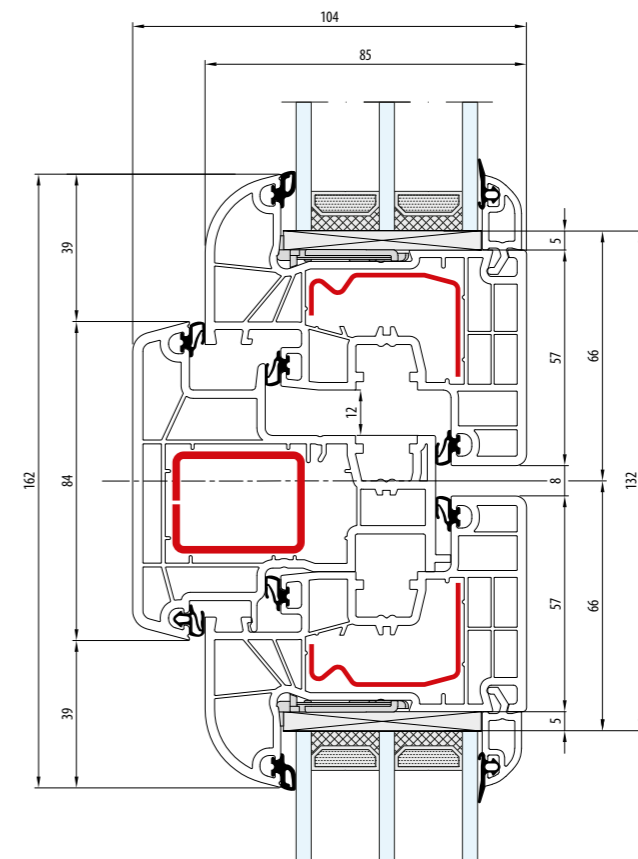
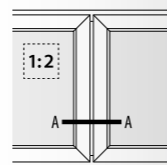

- Słupek ruchomy: 84 mm · Skrzydło: 77 mm
- Meneau mobile: 84 mm · Vantail: 77 mm
- Movable post: 84 mm · Sash: 77 mm
- Stulp: 84 mm · Flügel: 77 mm
- Montante mobile: 84 mm · Anta: 77 mm

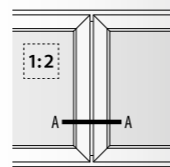
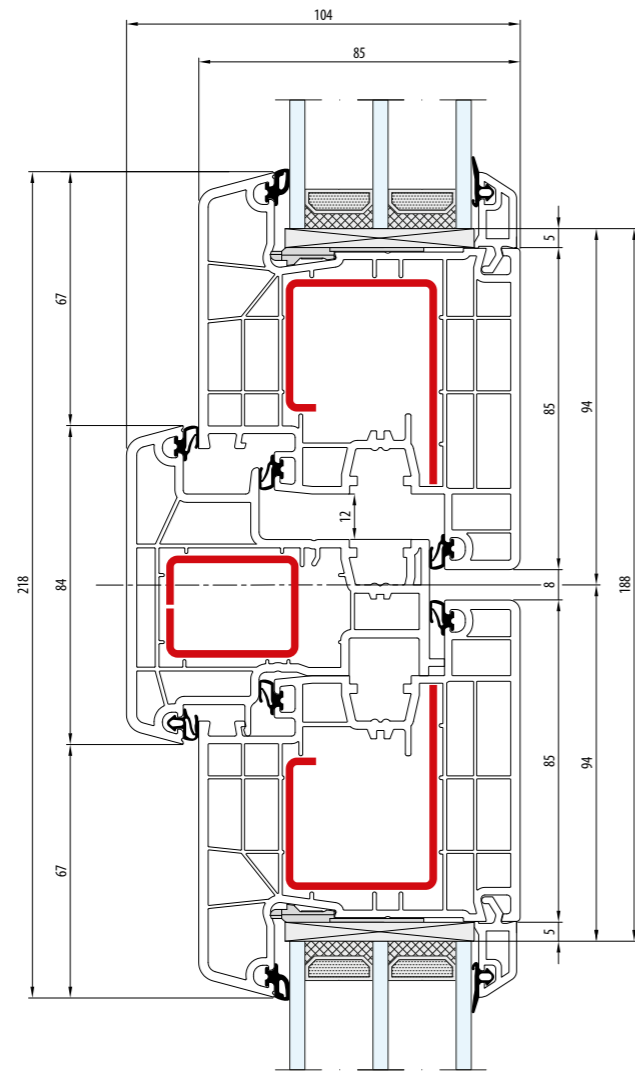

- Słupek ruchomy: 84 mm · Skrzydło: 105 mm
- Meneau mobile: 84 mm · Vantail: 105 mm
- Movable post: 84 mm · Sash: 105 mm
- Stulp: 84 mm · Flügel: 105 mm
- Montante mobile: 84 mm · Anta: 105 mm

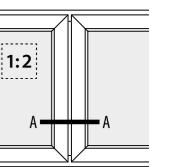
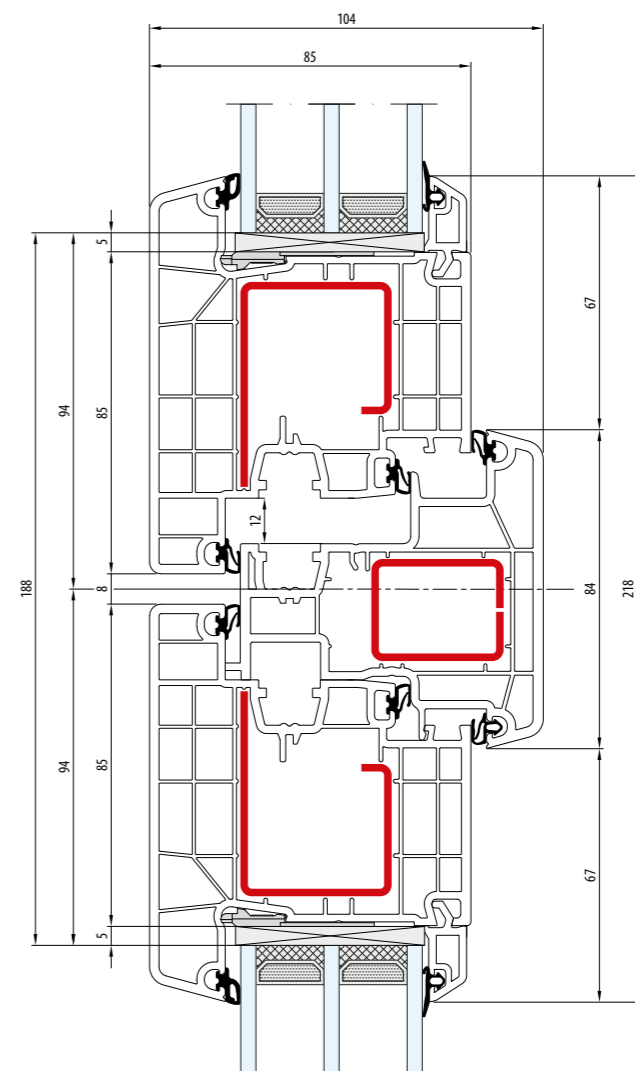

- Słupek ruchomy: 84 mm · Skrzydło: 105 mm
- Meneau mobile: 84 mm · Vantail: 105 mm
- Movable post: 84 mm · Sash: 105 mm
- Stulp: 84 mm · Flügel: 105 mm
- Montante mobile: 84 mm · Anta: 105 mm

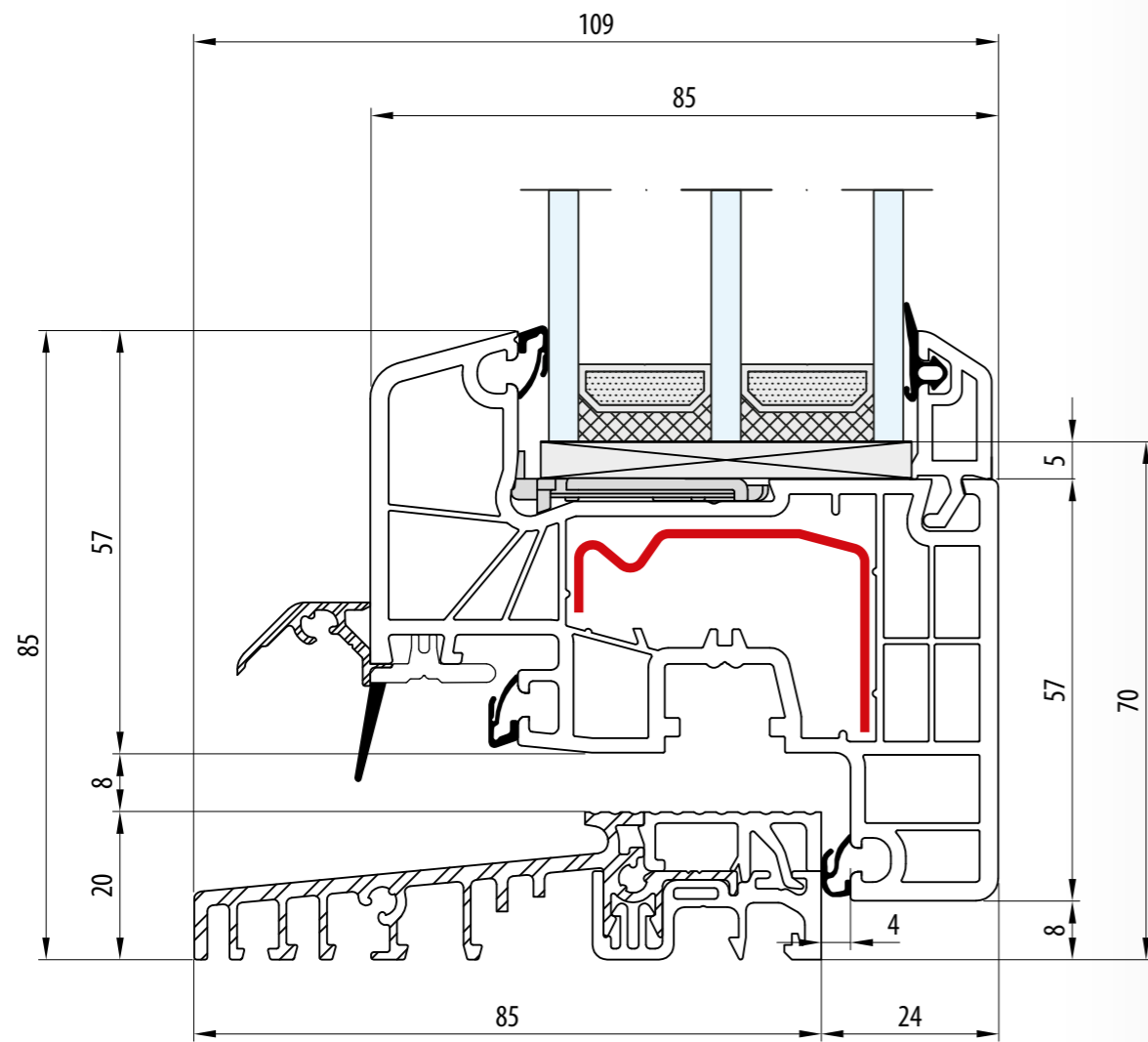

- Próg: 20 mm · Skrzydło: 77 mm
- Seuil: 20 mm · Vantail: 77 mm
- Threshold: 20 mm · Sash: 77 mm
- Schwelle: 20 mm · Flügel: 77 mm
- Soglia: 20 mm · Anta: 77 mm

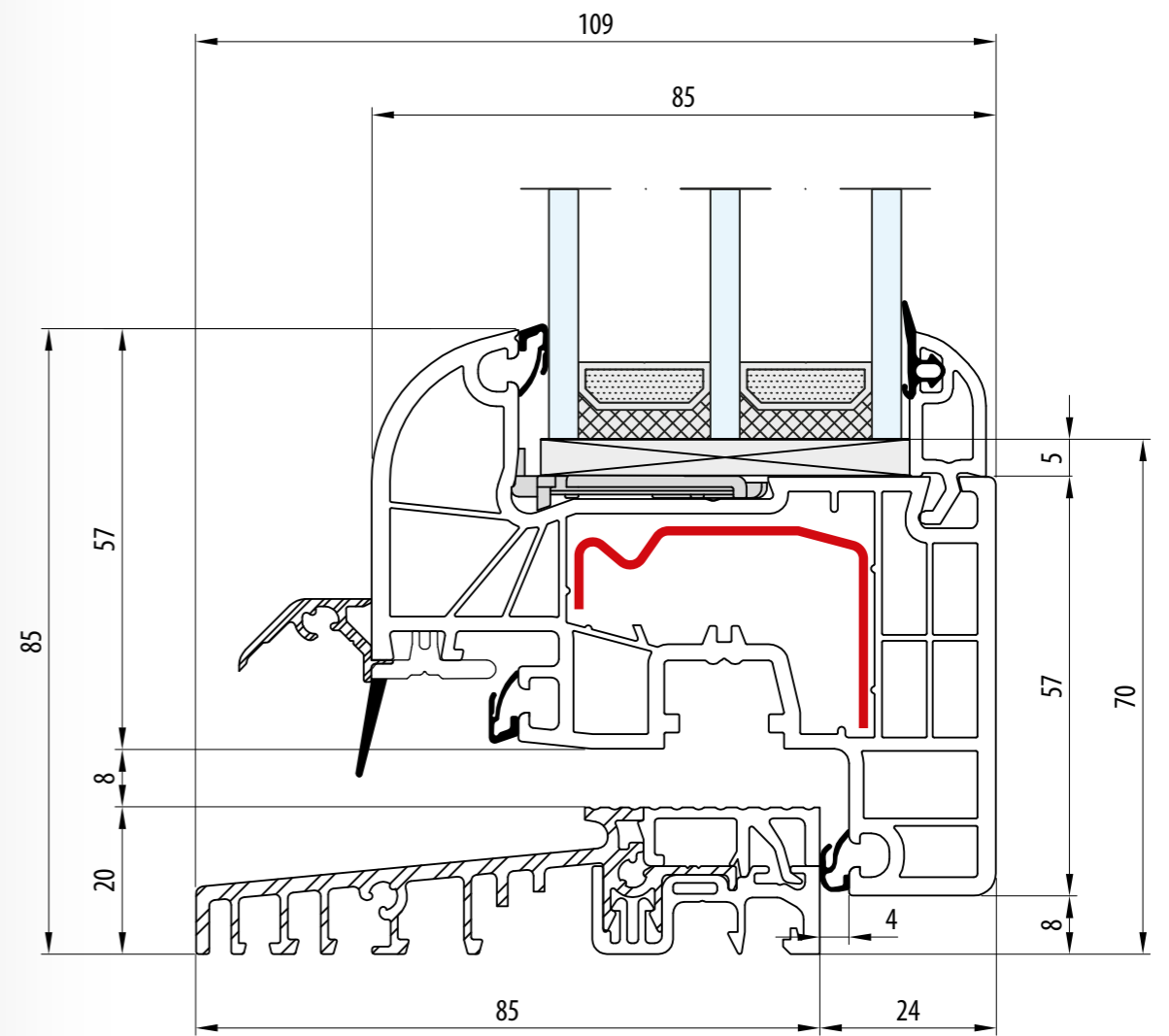
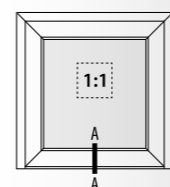

- Próg: 20 mm · Skrzydło: 77 mm
- Seuil: 20 mm · Vantail: 77 mm
- Threshold: 20 mm · Sash: 77 mm
- Schwelle: 20 mm · Flügel: 77 mm
- Soglia: 20 mm · Anta: 77 mm

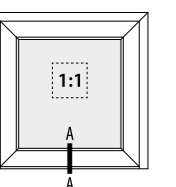

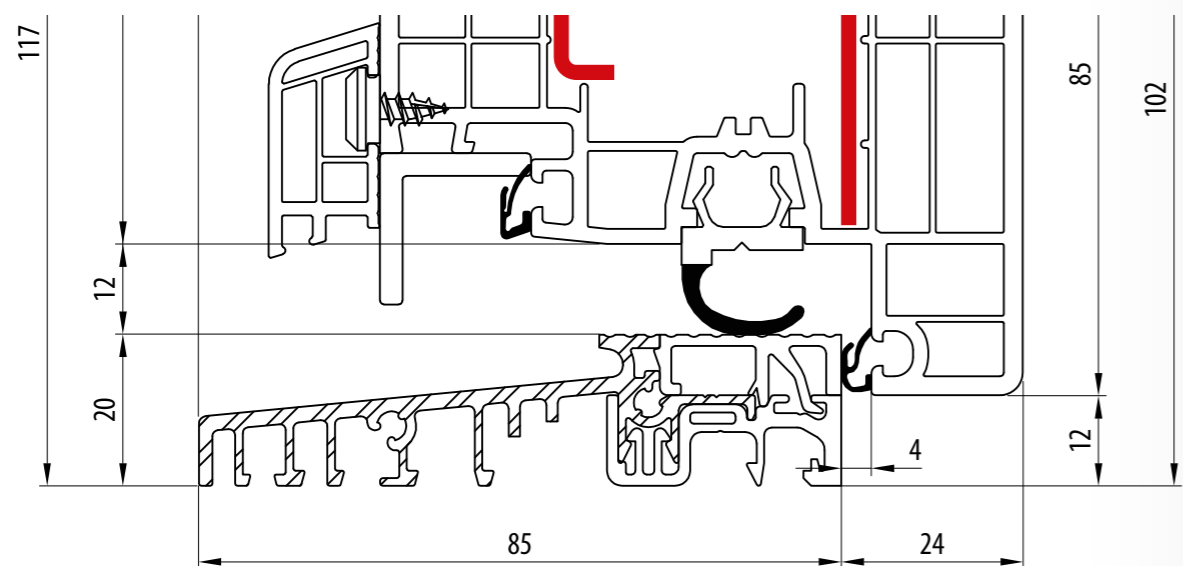
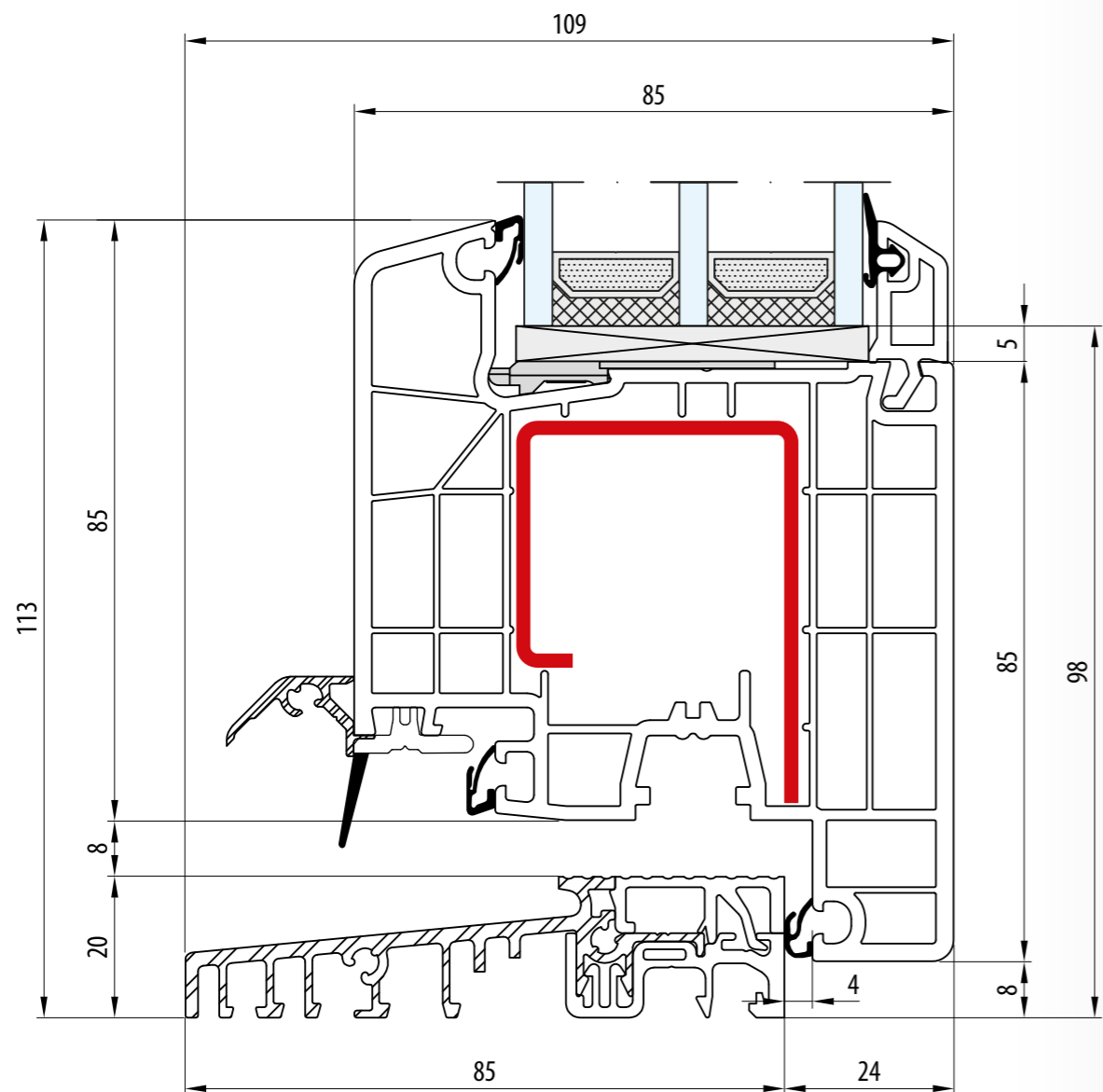

- Próg: 20 mm · Skrzydło: 105 mm
- Seuil: 20 mm · Vantail: 105 mm
- Threshold: 20 mm · Sash: 105 mm
- Schwelle: 20 mm · Flügel: 105 mm
- Soglia: 20 mm · Anta: 105 mm

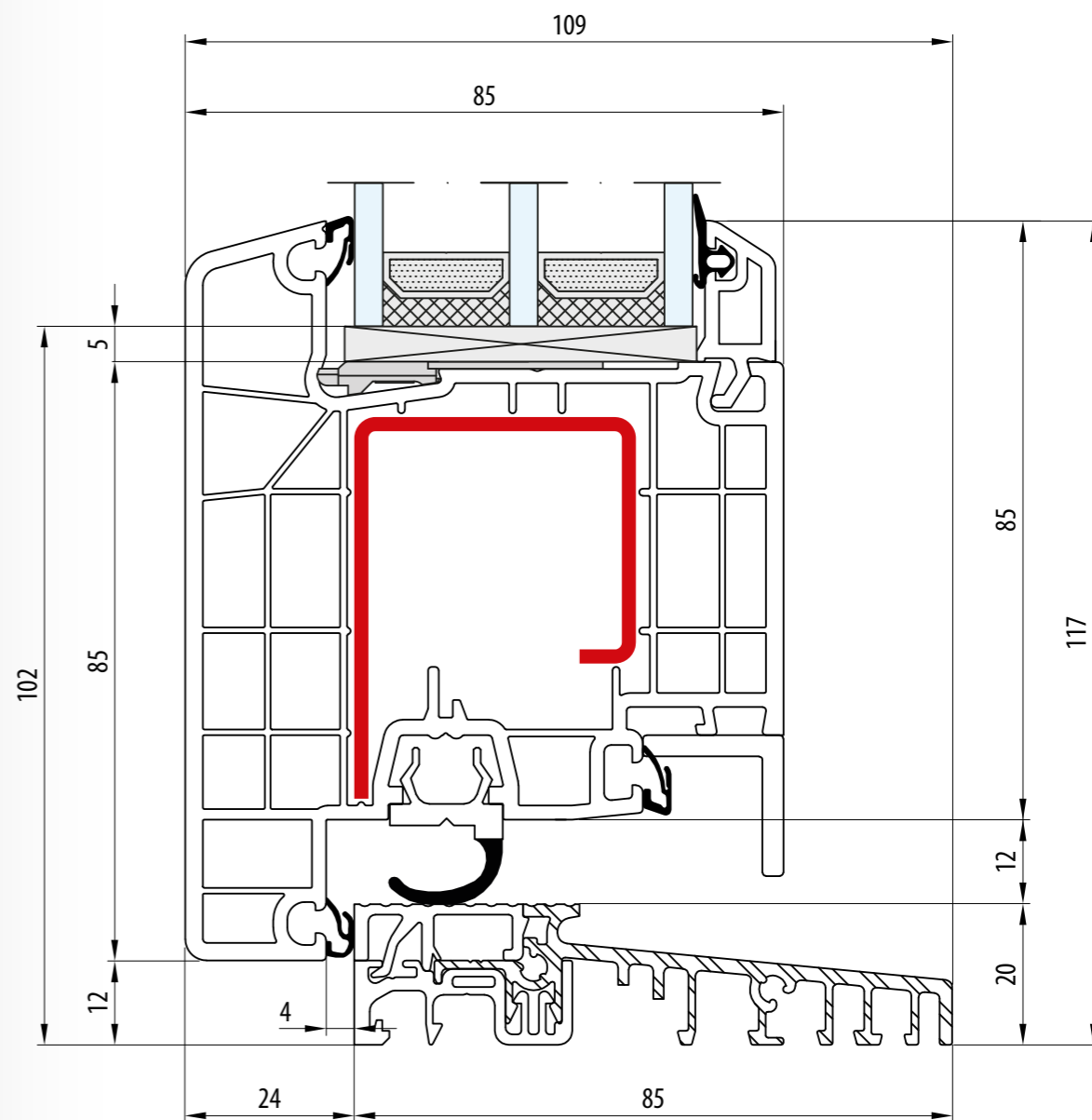
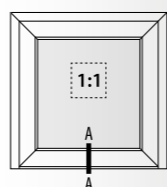

- Próg: 20 mm · Skrzydło: 105 mm
- Seuil: 20 mm · Vantail: 105 mm
- Threshold: 20 mm · Sash: 105 mm
- Schwelle: 20 mm · Flügel: 105 mm
- Soglia: 20 mm · Anta: 105 mm

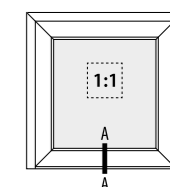

ENERGETO 8000

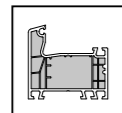
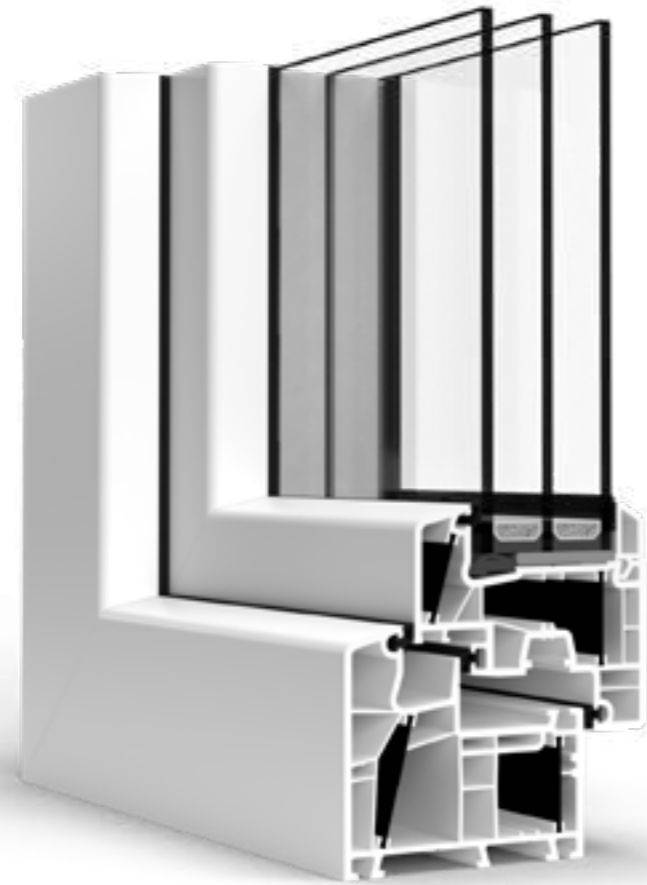

6



3

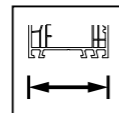

85

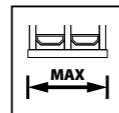

52

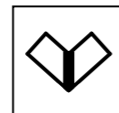

V-PERFECT
TECHNOLOGY



ALU



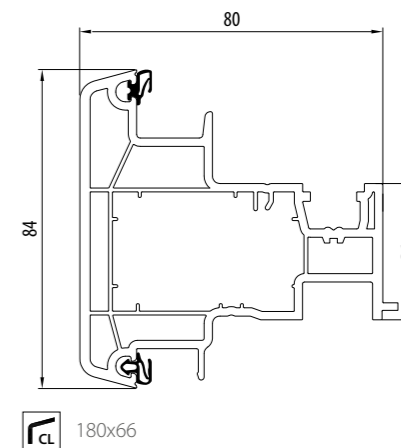
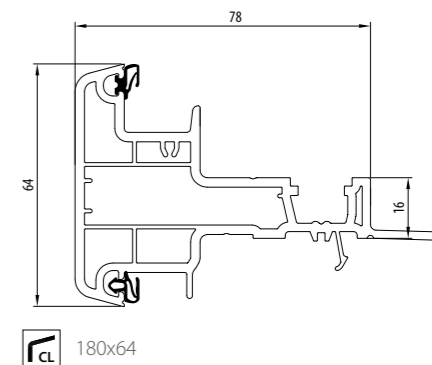
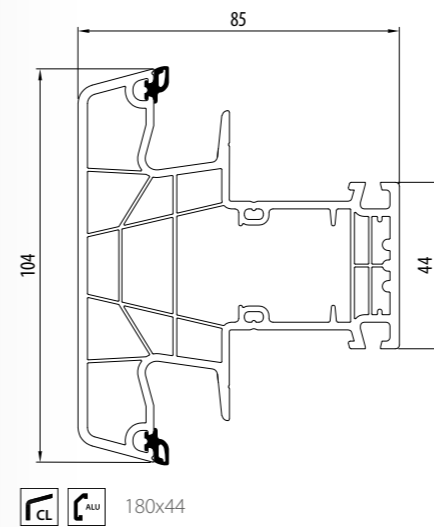
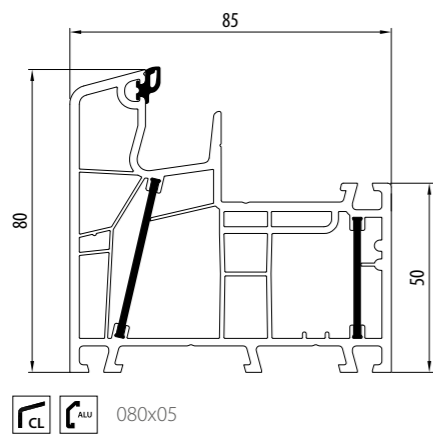
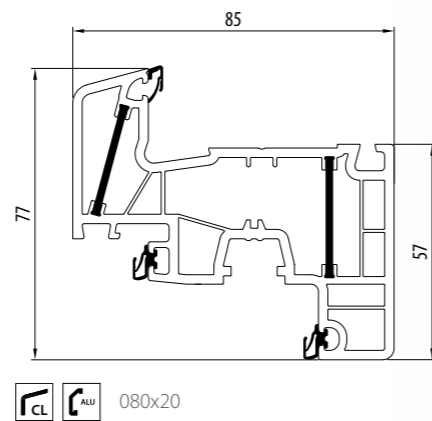
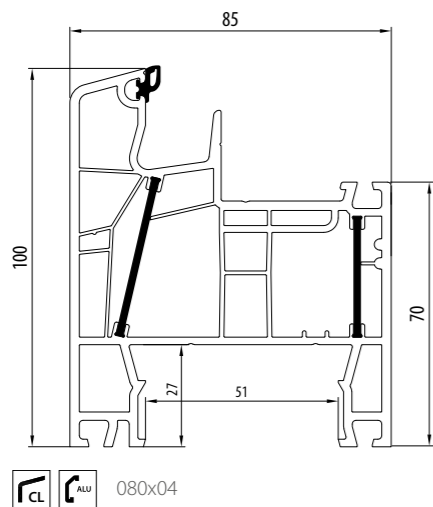

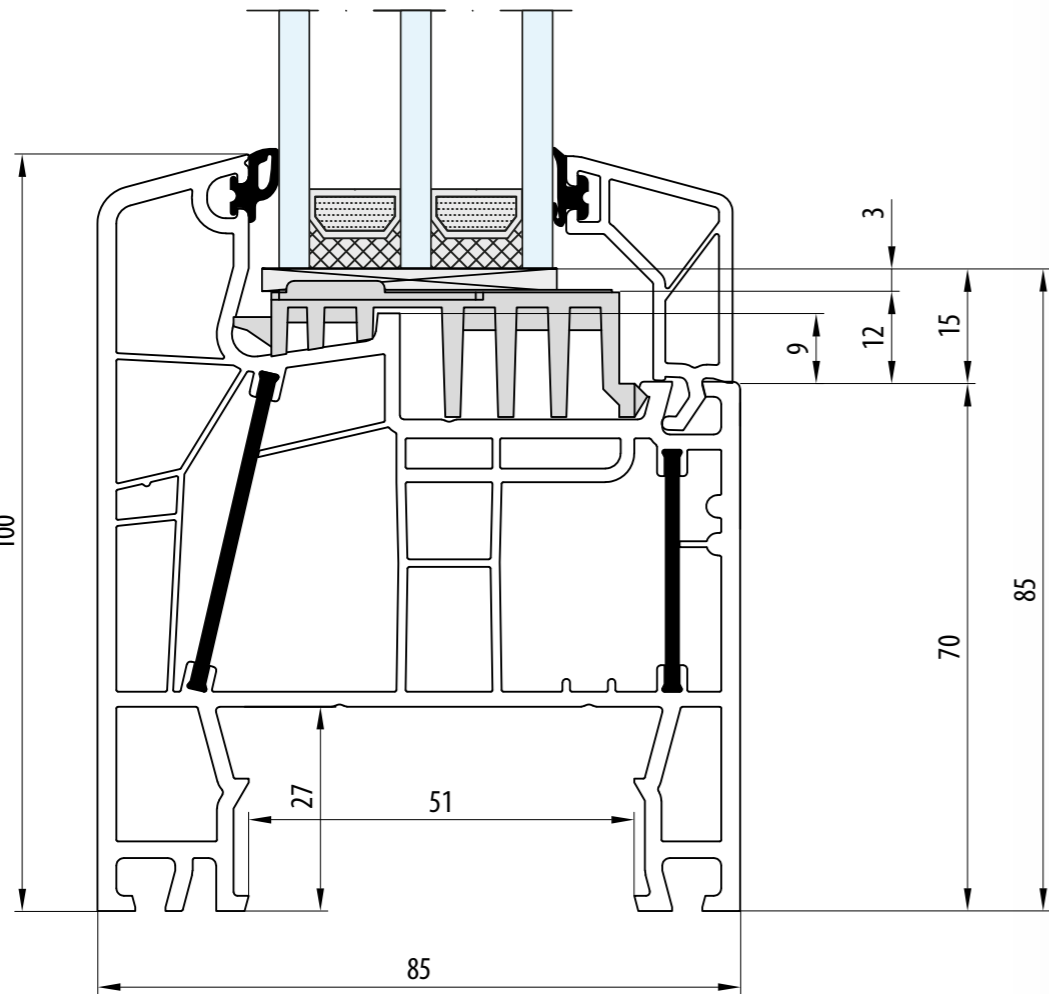
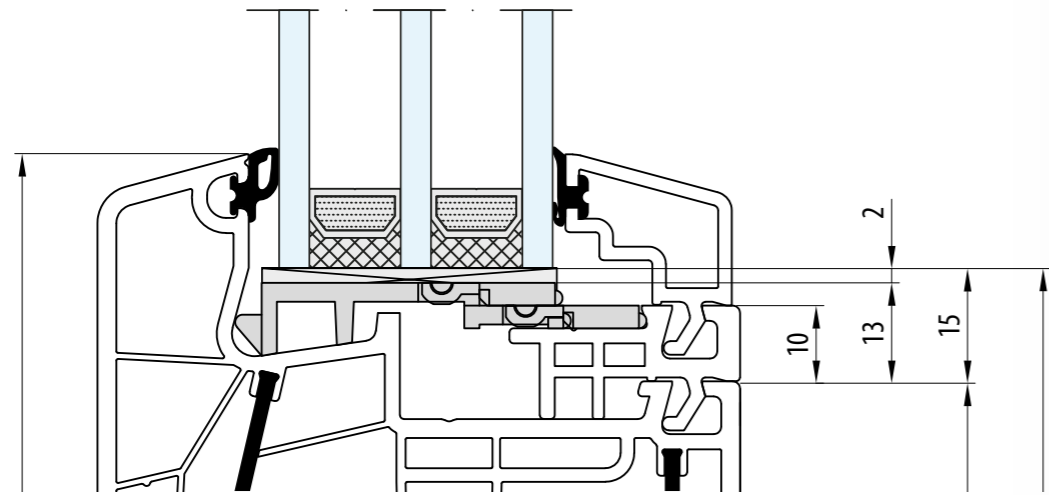

- Rama: 100 mm
- Dormant: 100 mm
- Frame: 100 mm
- Rahmen: 100 mm
- Telaio: 100 mm

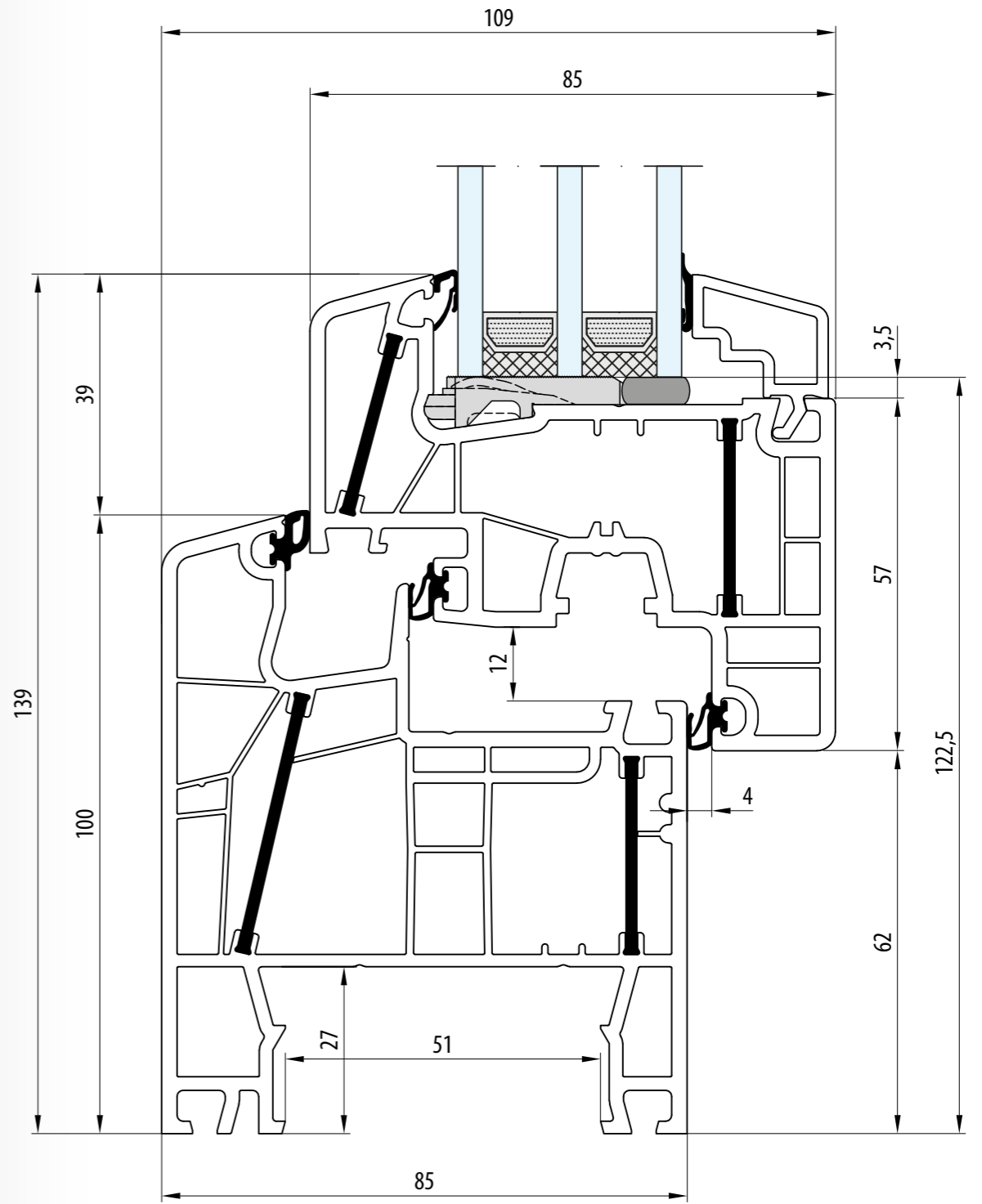
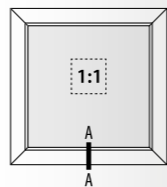

- Rama: 100 mm - Skrzydło: 77 mm
- Dormant: 100 mm - Vantail: 77 mm
- Frame: 100 mm - Sash: 77 mm
- Rahmen: 100 mm - Flügel: 77 mm
- Telaio: 100 mm - Anta: 77 mm

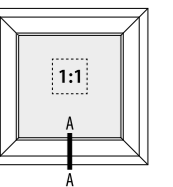

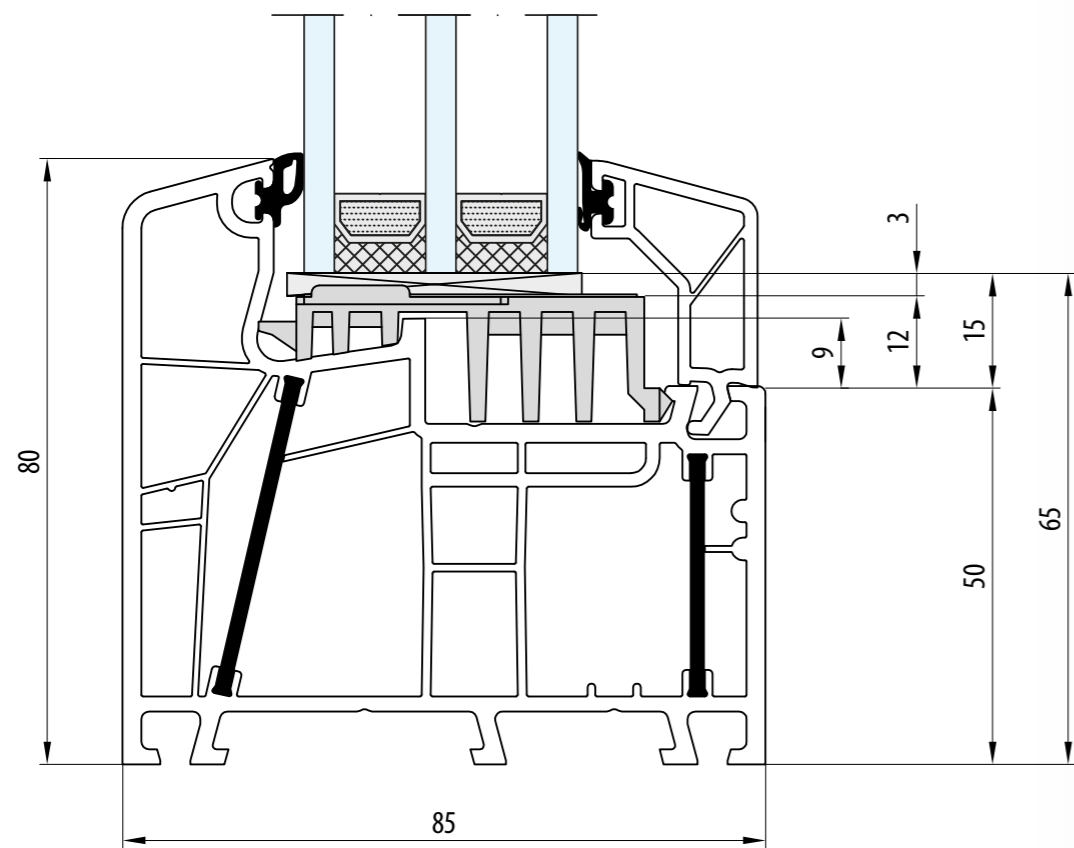
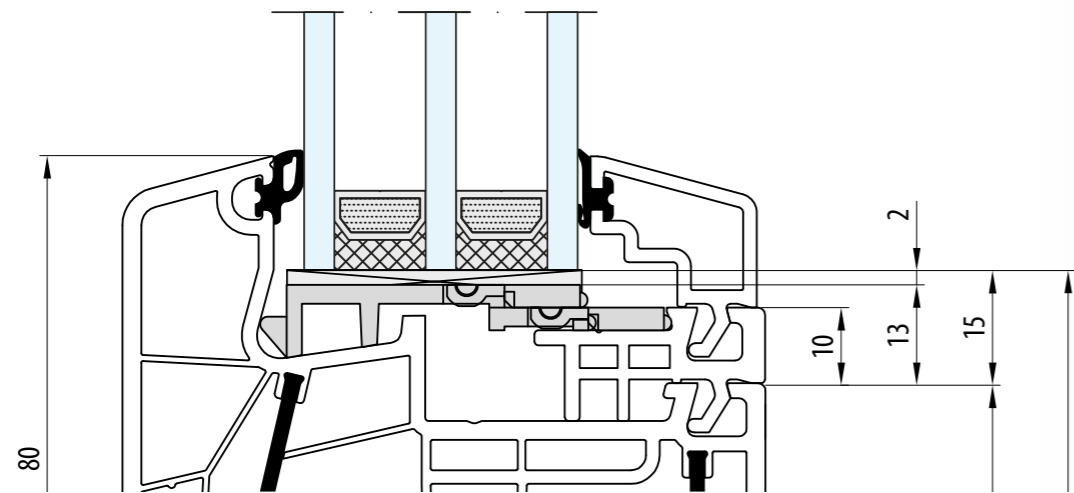

- Rama: 80 mm
- Dormant: 80 mm
- Frame: 80 mm
- Rahmen: 80 mm
- Telaio: 80 mm

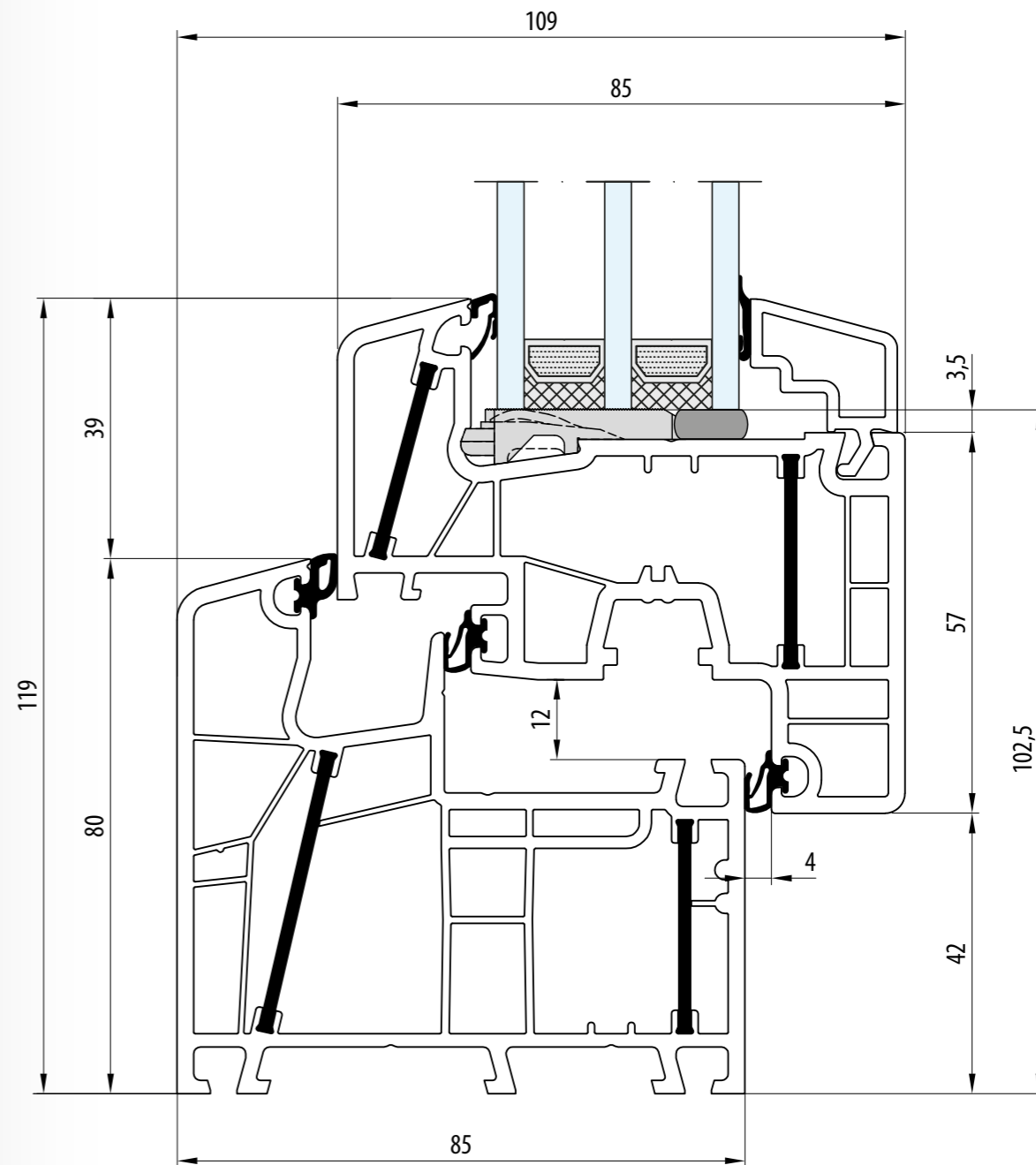
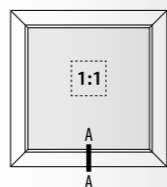

- Rama: 80 mm · Skrzydło: 77 mm
- Dormant: 80 mm · Vantail: 77 mm
- Frame: 80 mm · Sash: 77 mm
- Rahmen: 80 mm · Flügel: 77 mm
- Telaio: 80 mm · Anta: 77 mm

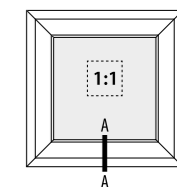

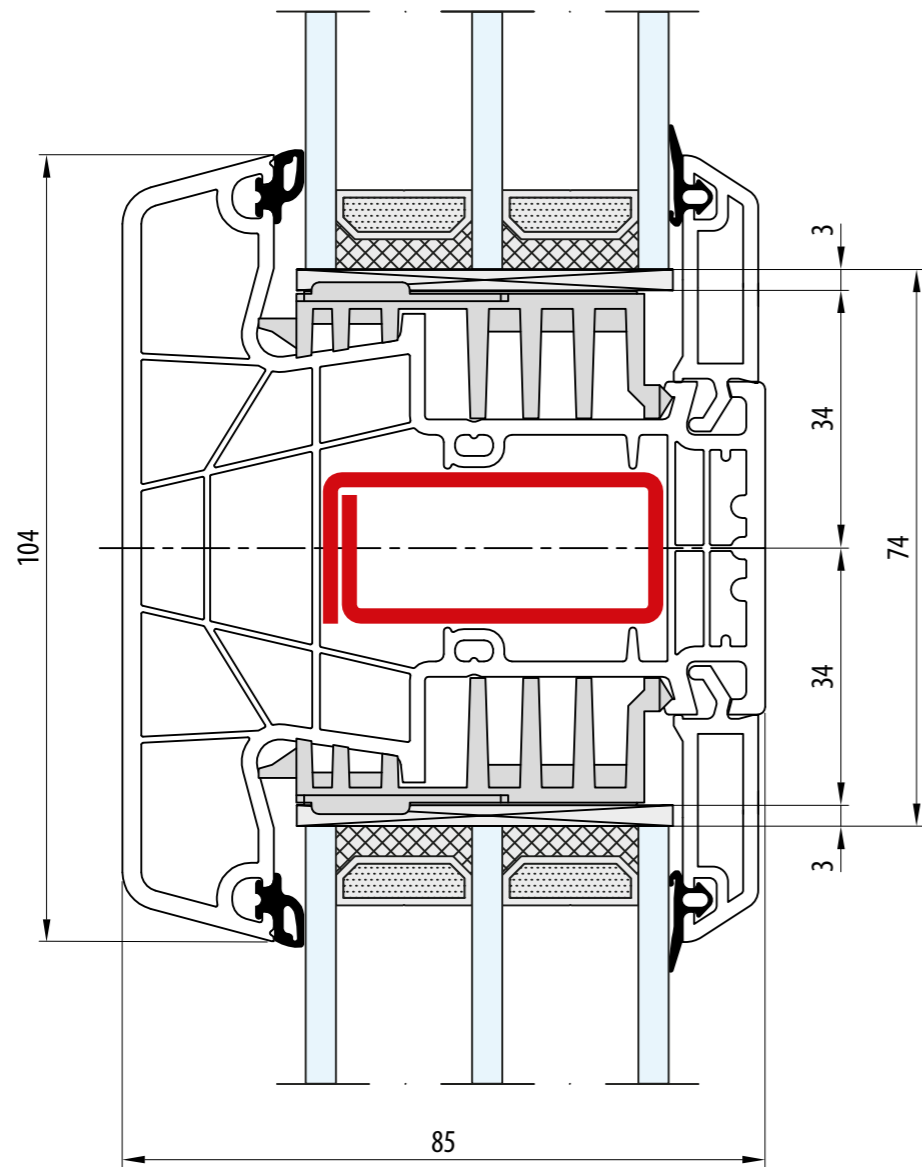



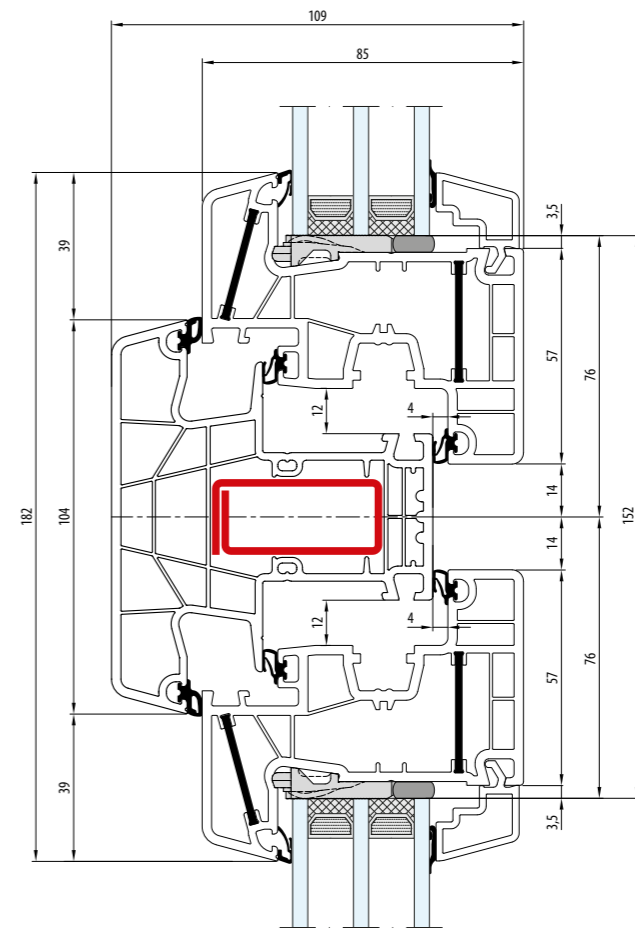
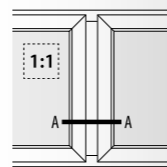

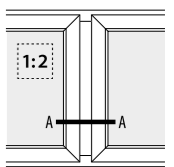

- Słupek stalowy: 104 mm
- Meneau fixe: 104 mm
- Fix post: 104 mm
- Festem Pfahl: 104 mm
- Montante fissa: 104 mm

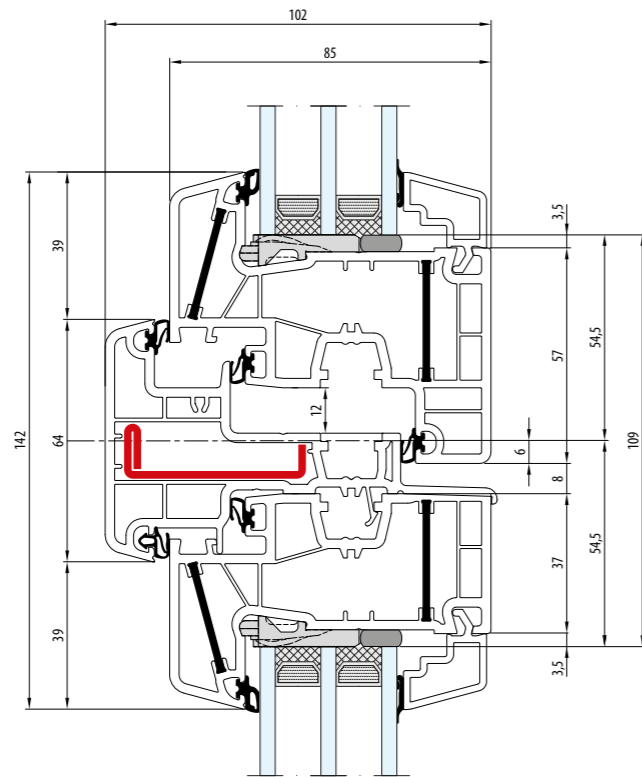







- Słupek stalowy: 104 mm · Skrzydło: 77 mm
- Meneau fixe: 104 mm · Vantail: 77 mm
- Fix post: 104 mm · Sash: 77 mm
- Festem Pfahl: 104 mm · Flügel: 77 mm
- Montante fissa: 104 mm · Anta: 77 mm

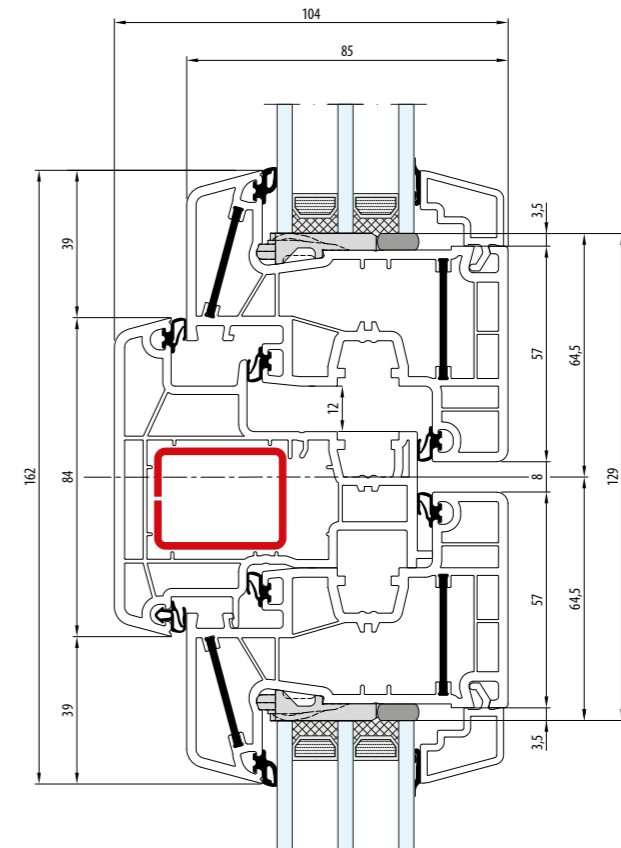
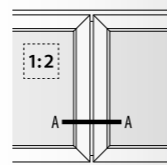



-  Słupek ruchomy: 64 mm · Skrzydło: 77 mm / 57 mm
-  Meneau mobile: 64 mm · Vantail: 77 mm / 57 mm
-  Movable post: 64 mm · Sash: 77 mm / 57 mm
-  Stulp: 64 mm · Flügel: 77 mm / 57 mm
-  Montante mobile: 64 mm · Anta: 77 mm / 57 mm



-  Słupek ruchomy: 84 mm · Skrzydło: 77 mm
-  Meneau mobile: 84 mm · Vantail: 77 mm
-  Movable post: 84 mm · Sash: 77 mm
-  Stulp: 84 mm · Flügel: 77 mm
-  Montante mobile: 84 mm · Anta: 77 mm

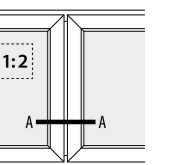

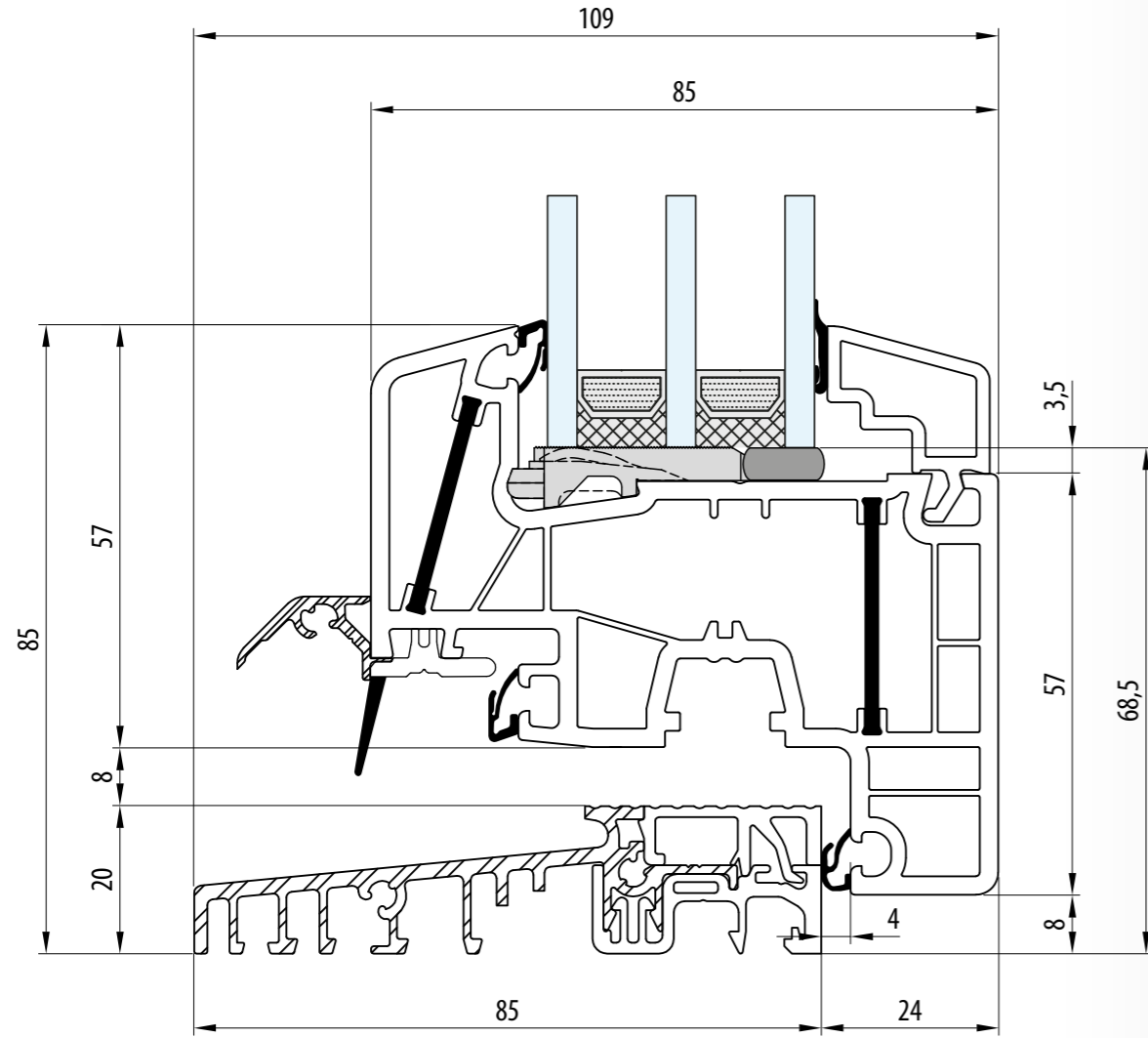

- Próg: 20 mm · Skrzydło: 77 mm
- Seuil: 20 mm · Vantail: 77 mm
- Threshold: 20 mm · Sash: 77 mm
- Schwelle: 20 mm · Flügel: 77 mm
- Soglia: 20 mm · Anta: 77 mm

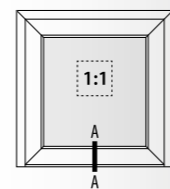

BLOCKPROFIL NL

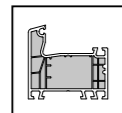

3



2

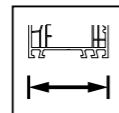

120

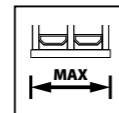

42

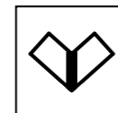

V SUPER SOLUTION

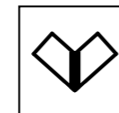

HFL



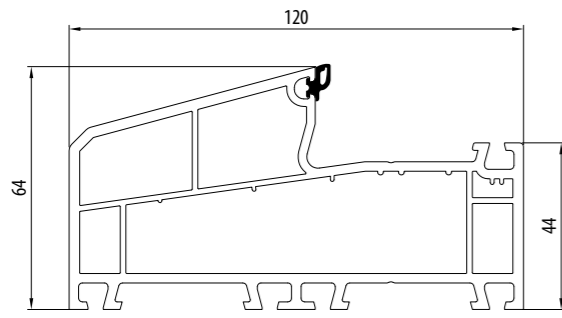

SL A* 140x53

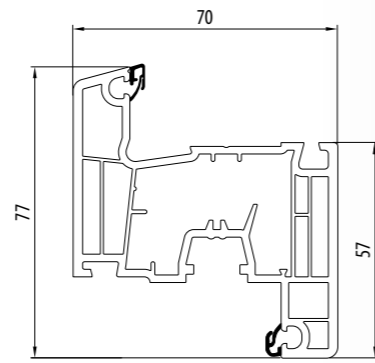

CL ALU 140x20

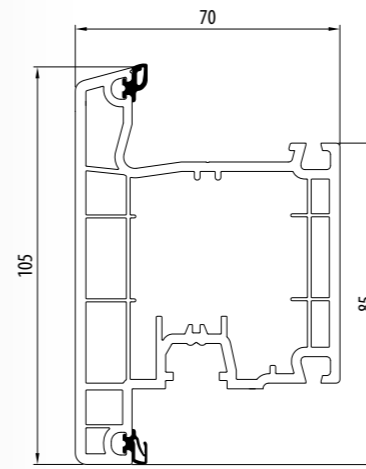

CL 140x31

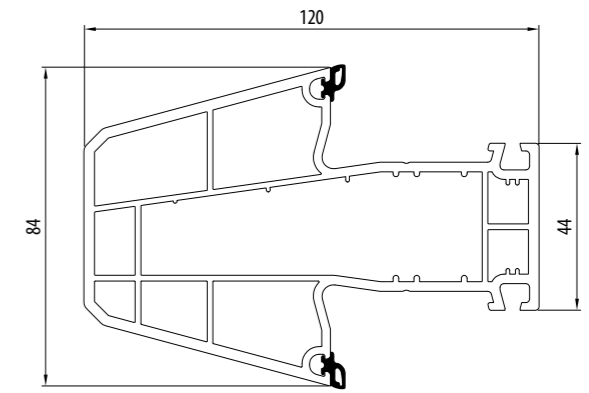

SL 140x57

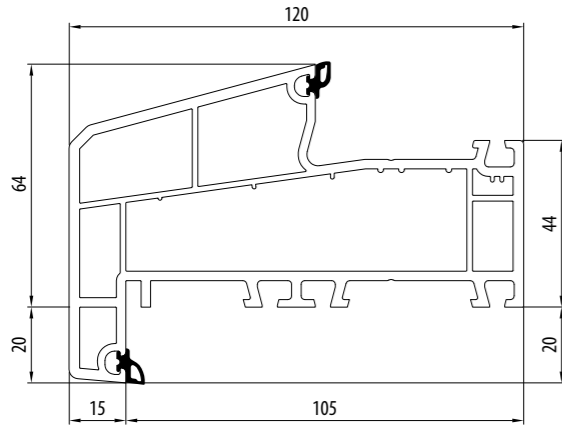

SL A* 140x54

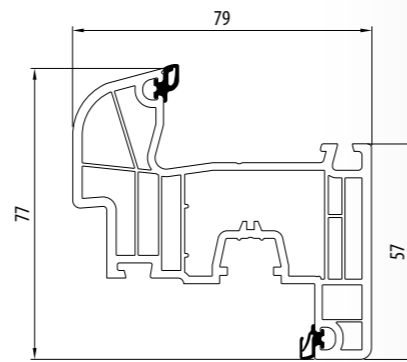

RL 140x22

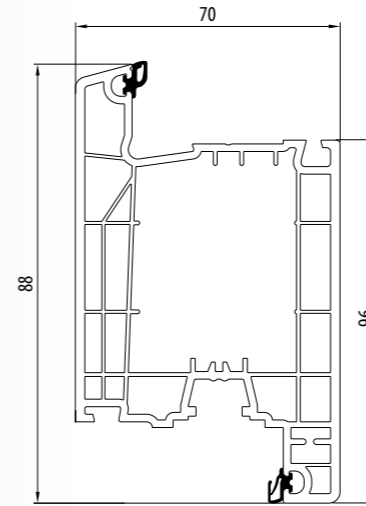

CL ALU 140x33

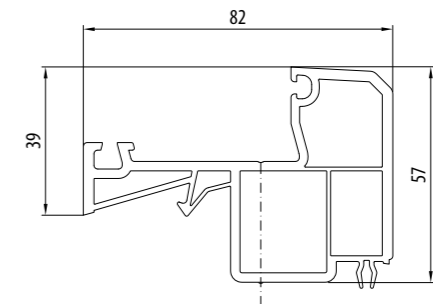

SL 140x58

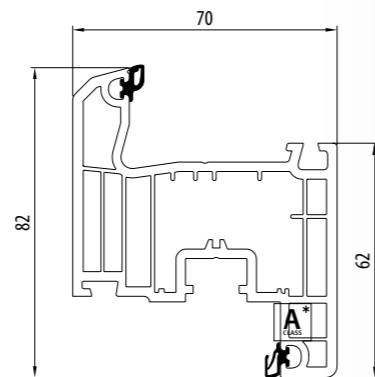

CL A* ALU 140x23

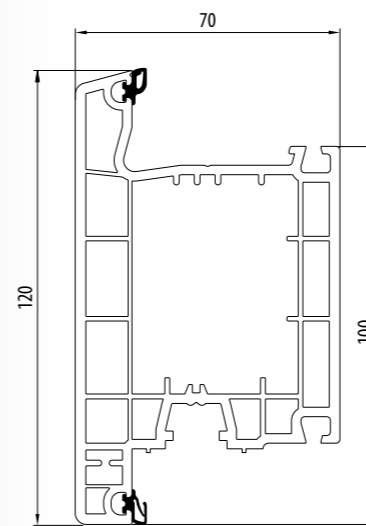

CL 140x35

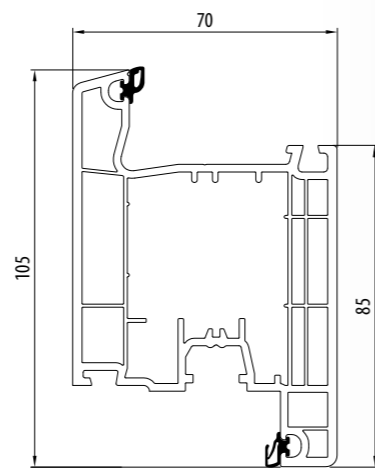

CL ALU 140x30

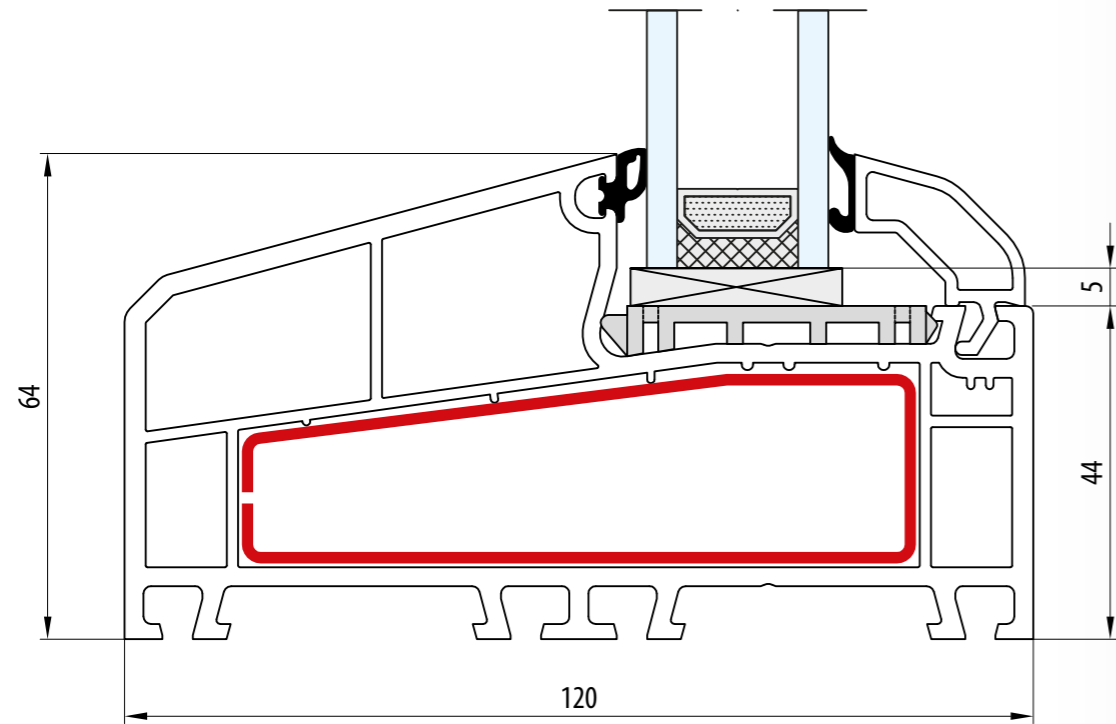

- Rama: 64 mm
- Dormant: 64 mm
- Frame: 64 mm
- Rahmen: 64 mm
- Telaio: 64 mm

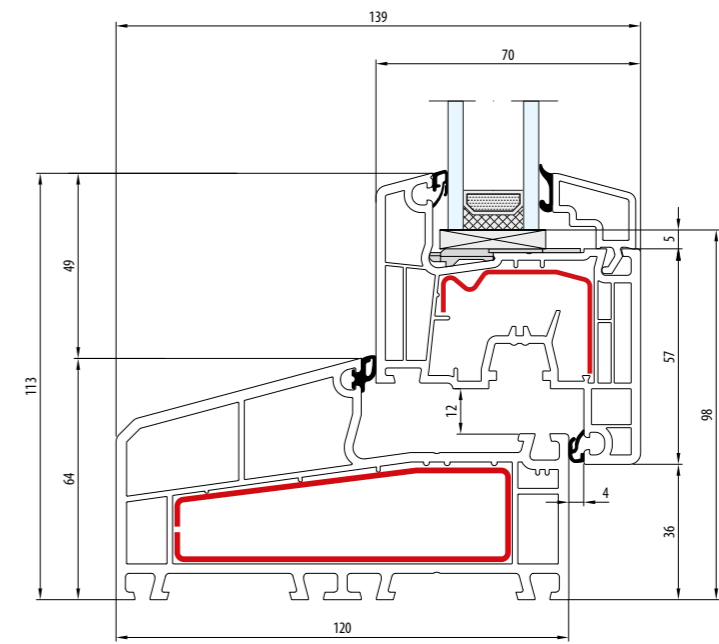
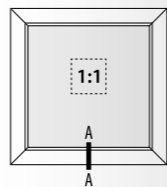

- Rama: 64 mm · Skrzydło: 77 mm
- Dormant: 64 mm · Vantail: 77 mm
- Frame: 64 mm · Sash: 77 mm
- Rahmen: 64 mm · Flügel: 77 mm
- Telaio: 64 mm · Anta: 77 mm

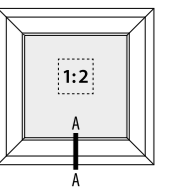

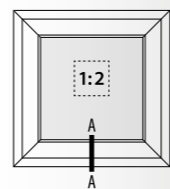
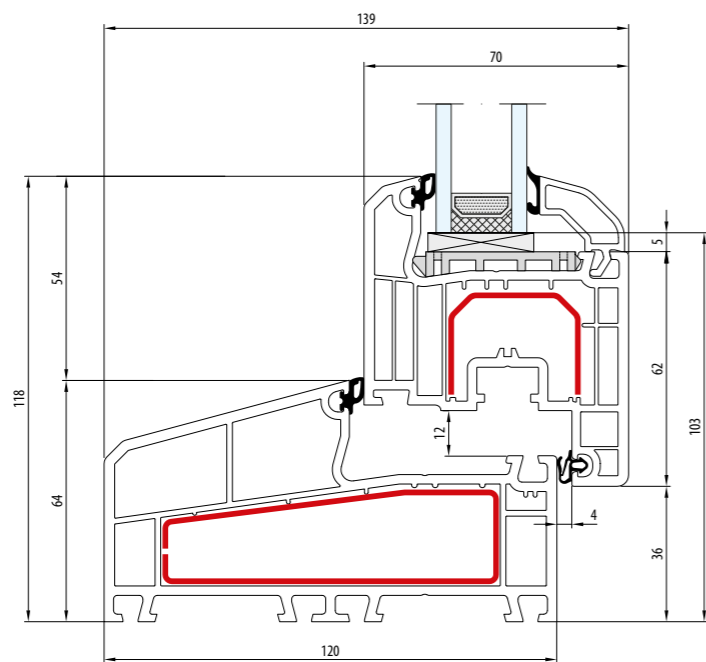

- Rama: 64 mm · Skrzydło: 82 mm
- Dormant: 64 mm · Vantail: 82 mm
- Frame: 64 mm · Sash: 82 mm
- Rahmen: 64 mm · Flügel: 82 mm
- Telaio: 64 mm · Anta: 82 mm

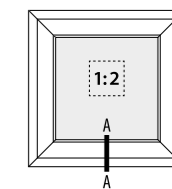
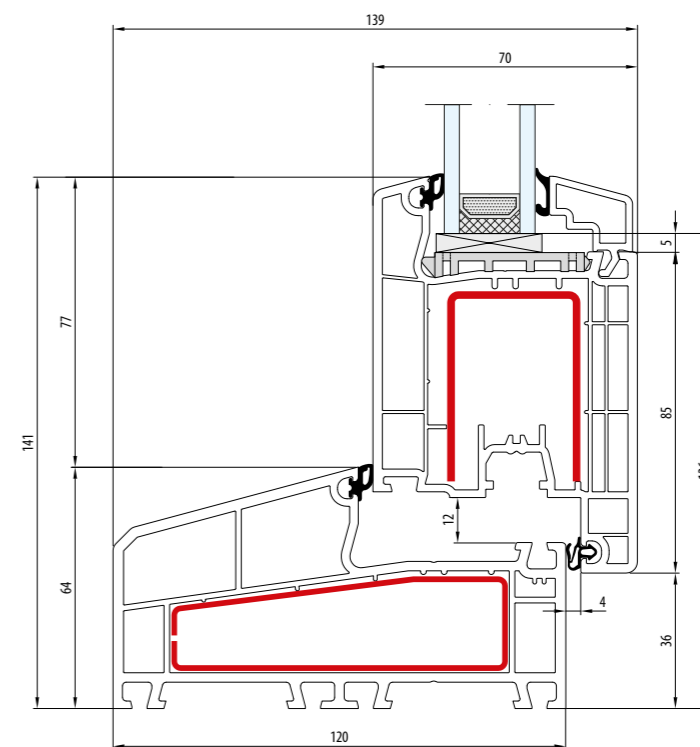

- Rama: 64 mm · Skrzydło: 105 mm
- Dormant: 64 mm · Vantail: 105 mm
- Frame: 64 mm · Sash: 105 mm
- Rahmen: 64 mm · Flügel: 105 mm
- Telaio: 64 mm · Anta: 105 mm

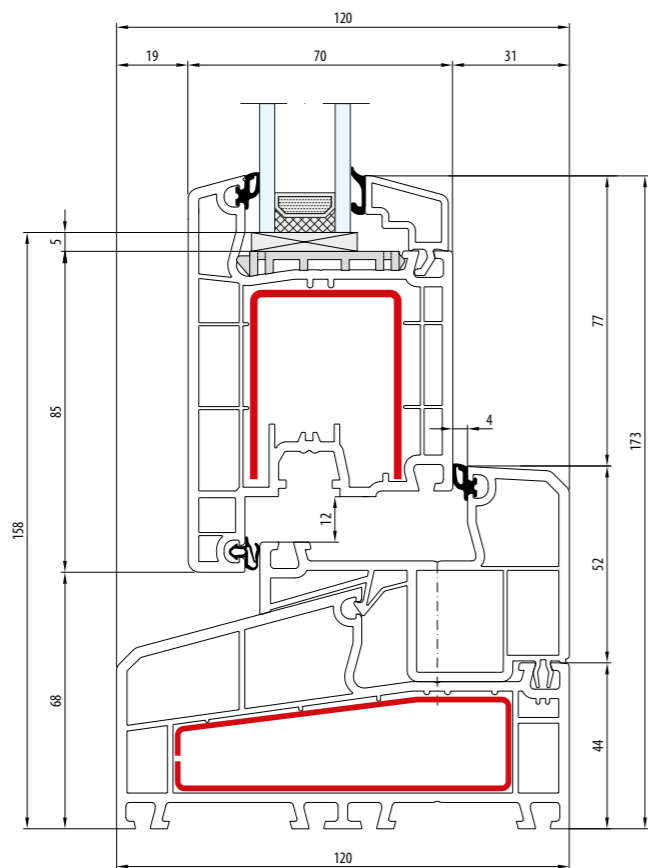

- Rama: 68 mm · Skrzydło: 105 mm
- Dormant: 68 mm · Vantail: 105 mm
- Frame: 68 mm · Sash: 105 mm
- Rahmen: 68 mm · Flügel: 105 mm
- Telaio: 68 mm · Anta: 105 mm

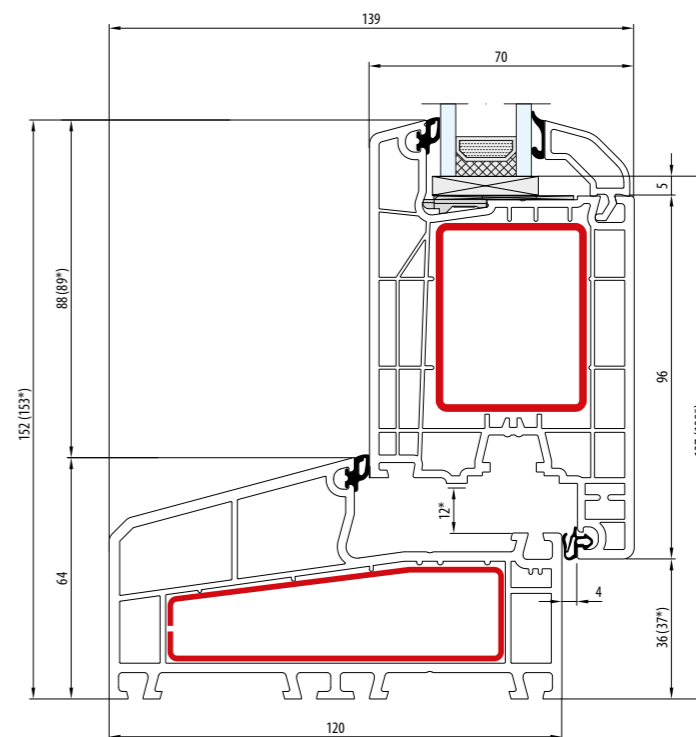
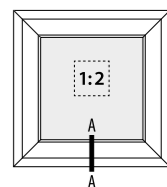
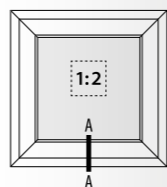

- Rama: 64 mm · Skrzydło: 116 mm
- Dormant: 64 mm · Vantail: 116 mm
- Frame: 64 mm · Sash: 116 mm
- Rahmen: 64 mm · Flügel: 116 mm
- Telaio: 64 mm · Anta: 116 mm

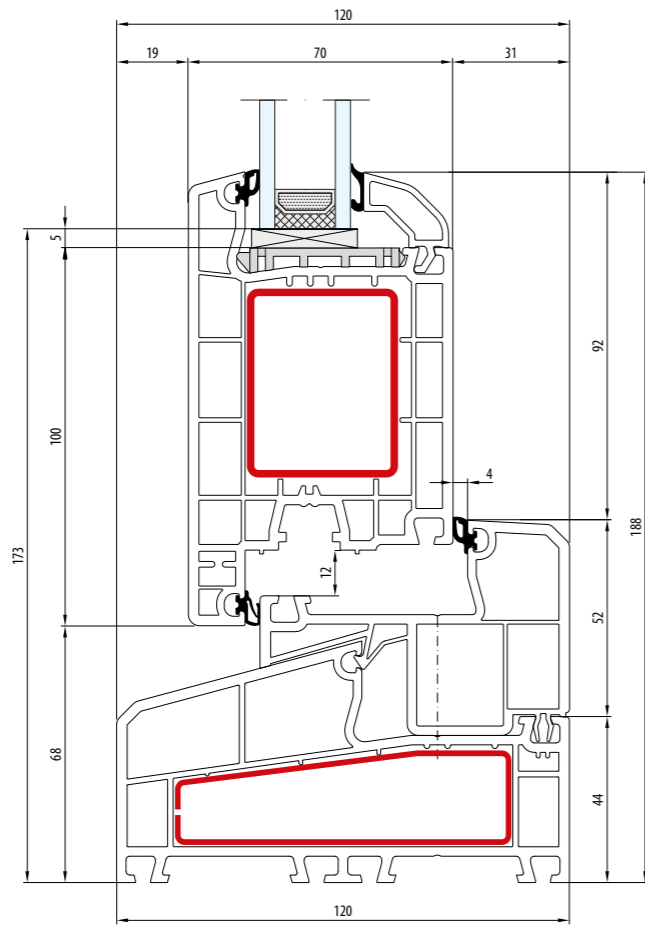

- Rama: 68 mm · Skrzydło: 120 mm
- Dormant: 68 mm · Vantail: 120 mm
- Frame: 68 mm · Sash: 120 mm
- Rahmen: 68 mm · Flügel: 120 mm
- Telaio: 68 mm · Anta: 120 mm

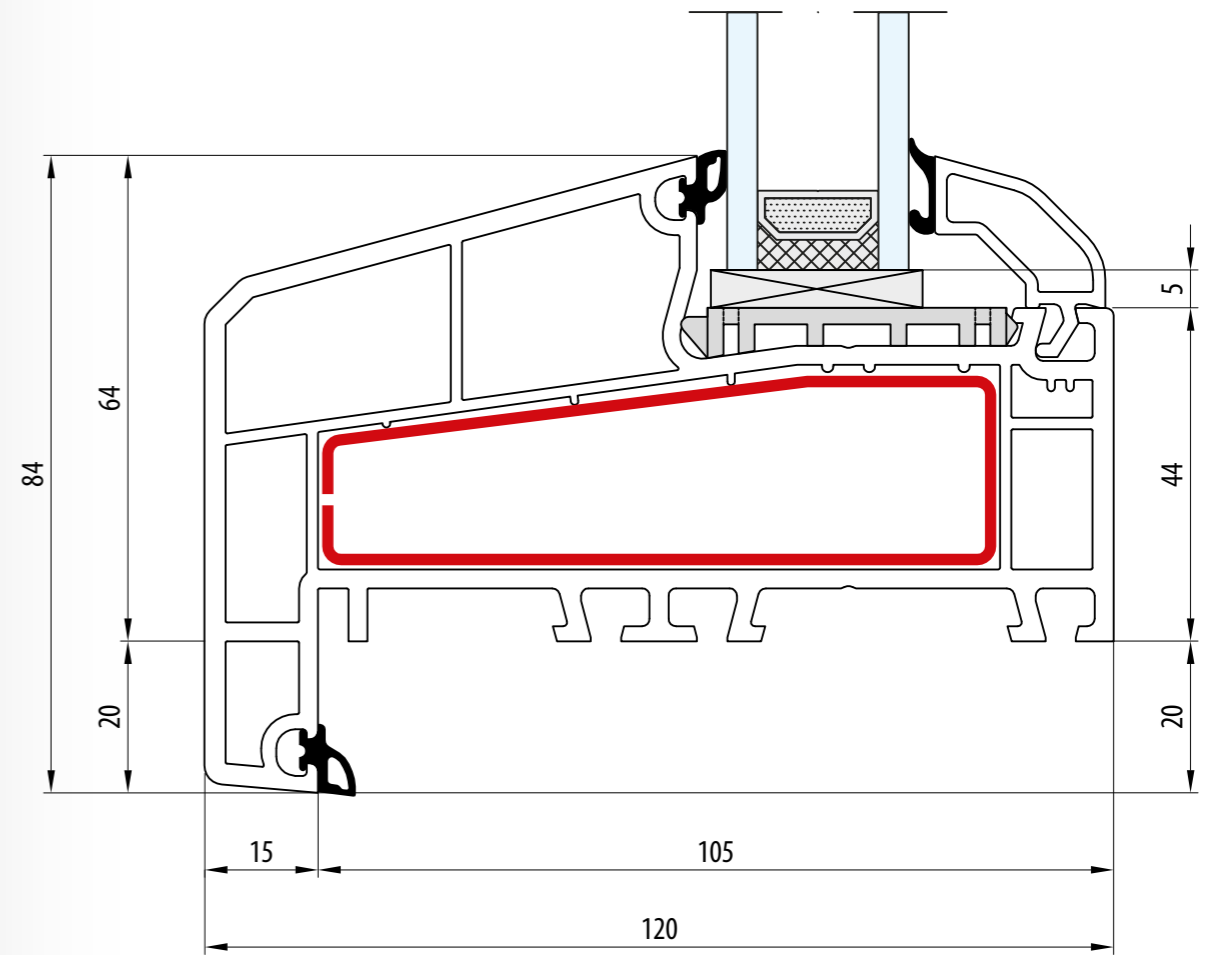
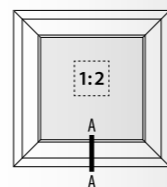

- Rama: 84 mm
- Dormant: 84 mm
- Frame: 84 mm
- Rahmen: 84 mm
- Telaio: 84 mm

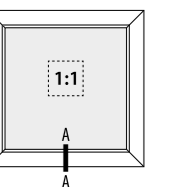

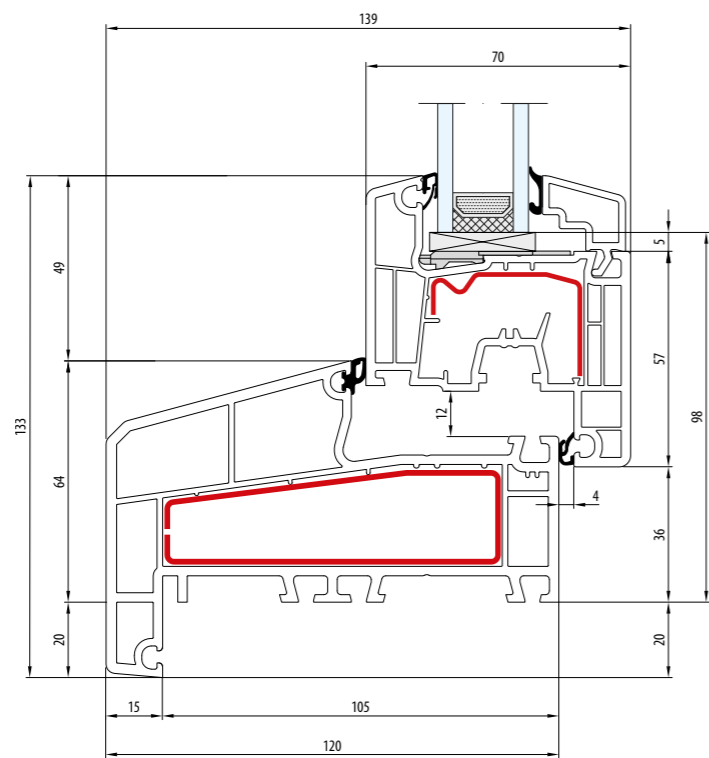

- Rama: 84 mm · Skrzydło: 77 mm
- Dormant: 84 mm · Vantail: 77 mm
- Frame: 84 mm · Sash: 77 mm
- Rahmen: 84 mm · Flügel: 77 mm
- Telaio: 84 mm · Anta: 77 mm

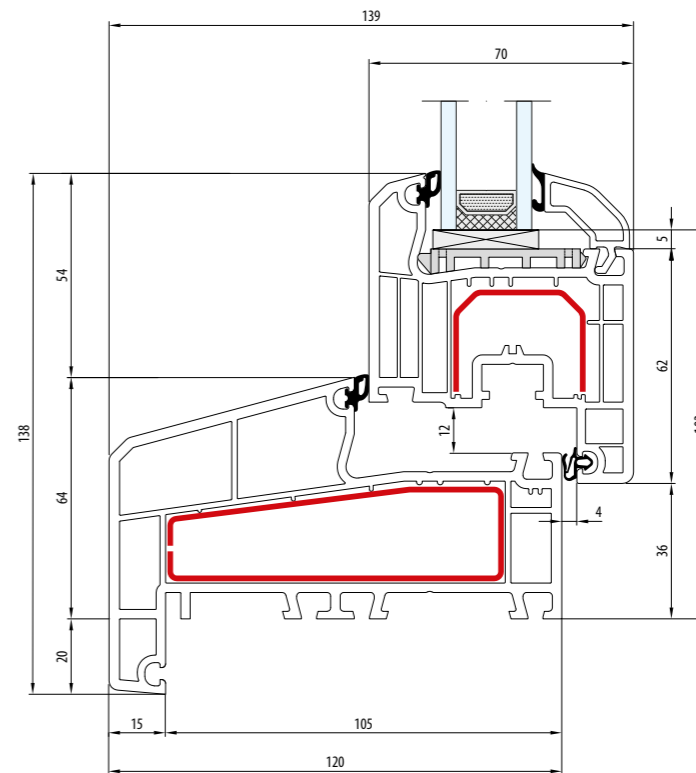
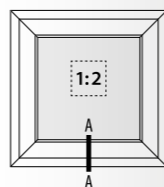

- Rama: 84 mm · Skrzydło: 82 mm
- Dormant: 84 mm · Vantail: 82 mm
- Frame: 84 mm · Sash: 82 mm
- Rahmen: 84 mm · Flügel: 82 mm
- Telaio: 84 mm · Anta: 82 mm

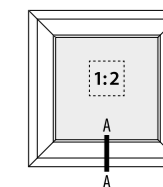

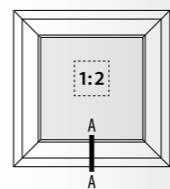
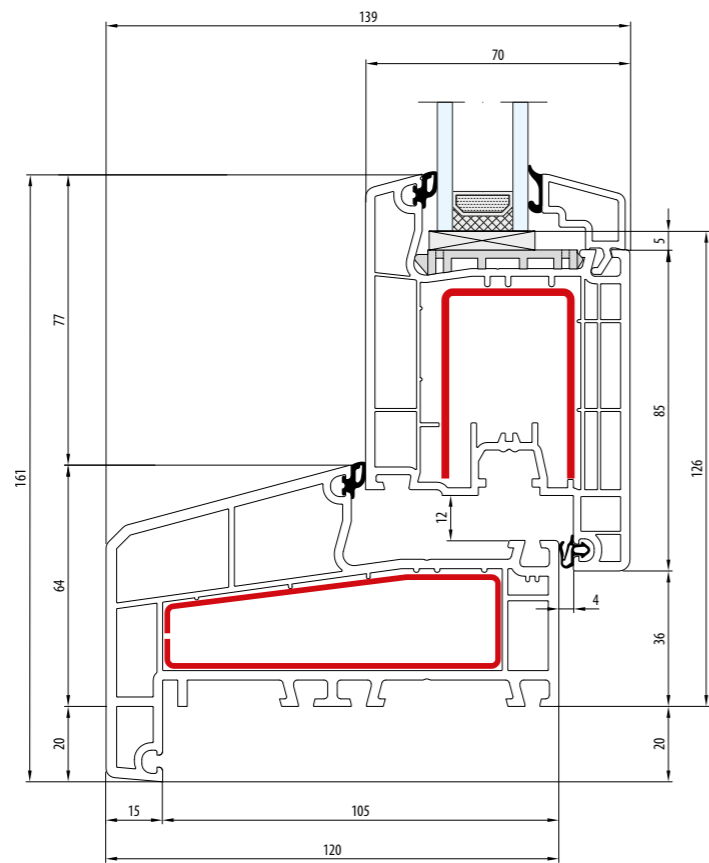

- Rama: 84 mm · Skrzydło: 105 mm
- Dormant: 84 mm · Vantail: 105 mm
- Frame: 84 mm · Sash: 105 mm
- Rahmen: 84 mm · Flügel: 105 mm
- Telaio: 84 mm · Anta: 105 mm

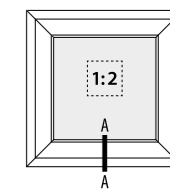
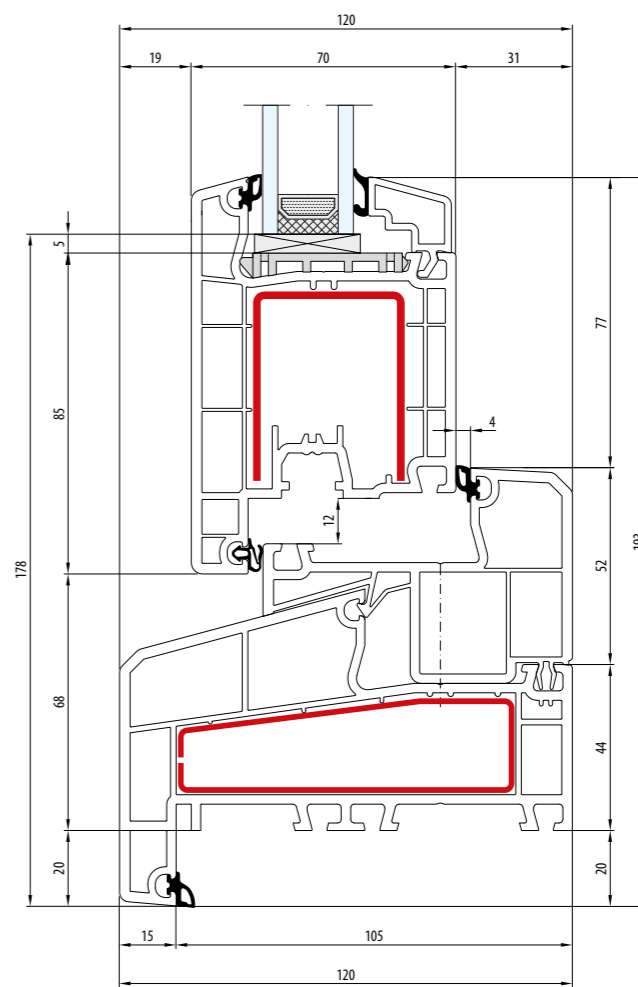

- Rama: 88 mm · Skrzydło: 105 mm
- Dormant: 88 mm · Vantail: 105 mm
- Frame: 88 mm · Sash: 105 mm
- Rahmen: 88 mm · Flügel: 105 mm
- Telaio: 88 mm · Anta: 105 mm

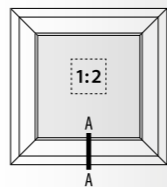
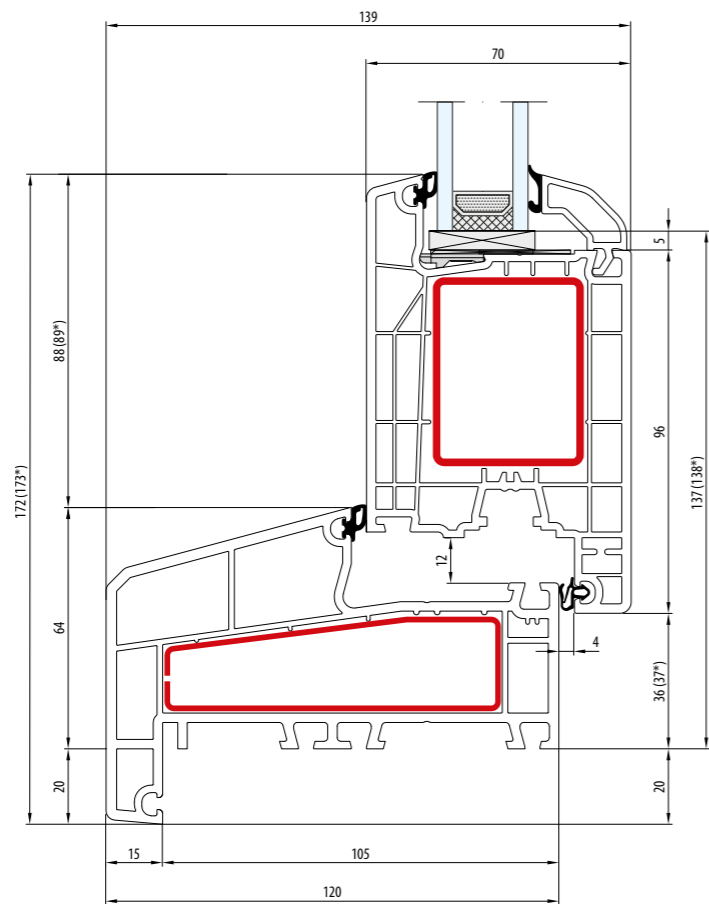



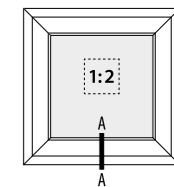
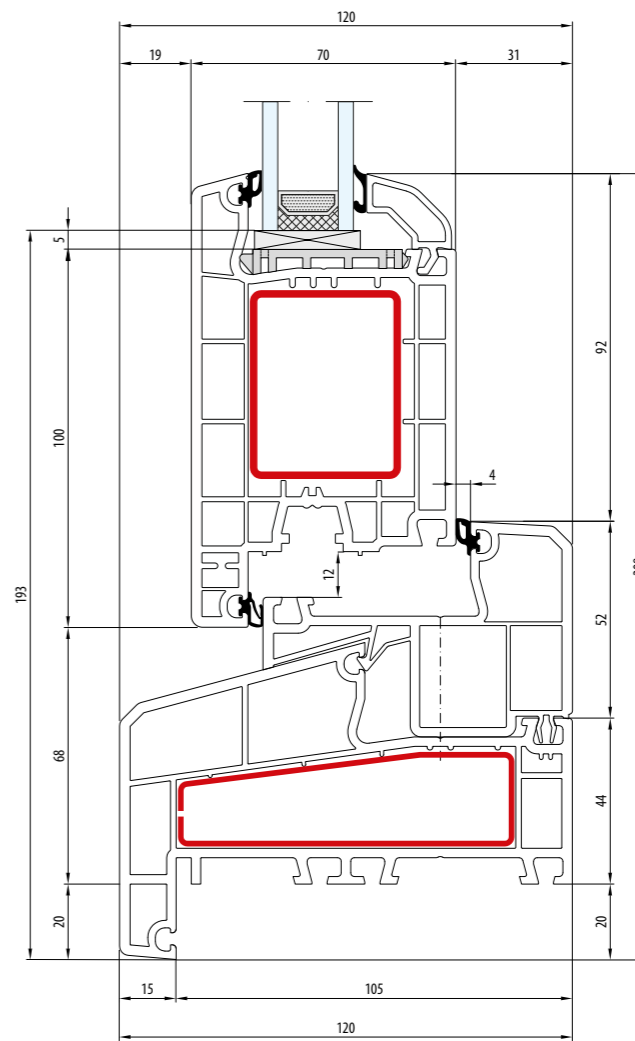

- Rama: 84 mm · Skrzydło: 116 mm
- Dormant: 84 mm · Vantail: 116 mm
- Frame: 84 mm · Sash: 116 mm
- Rahmen: 84 mm · Flügel: 116 mm
- Telaio: 84 mm · Anta: 116 mm

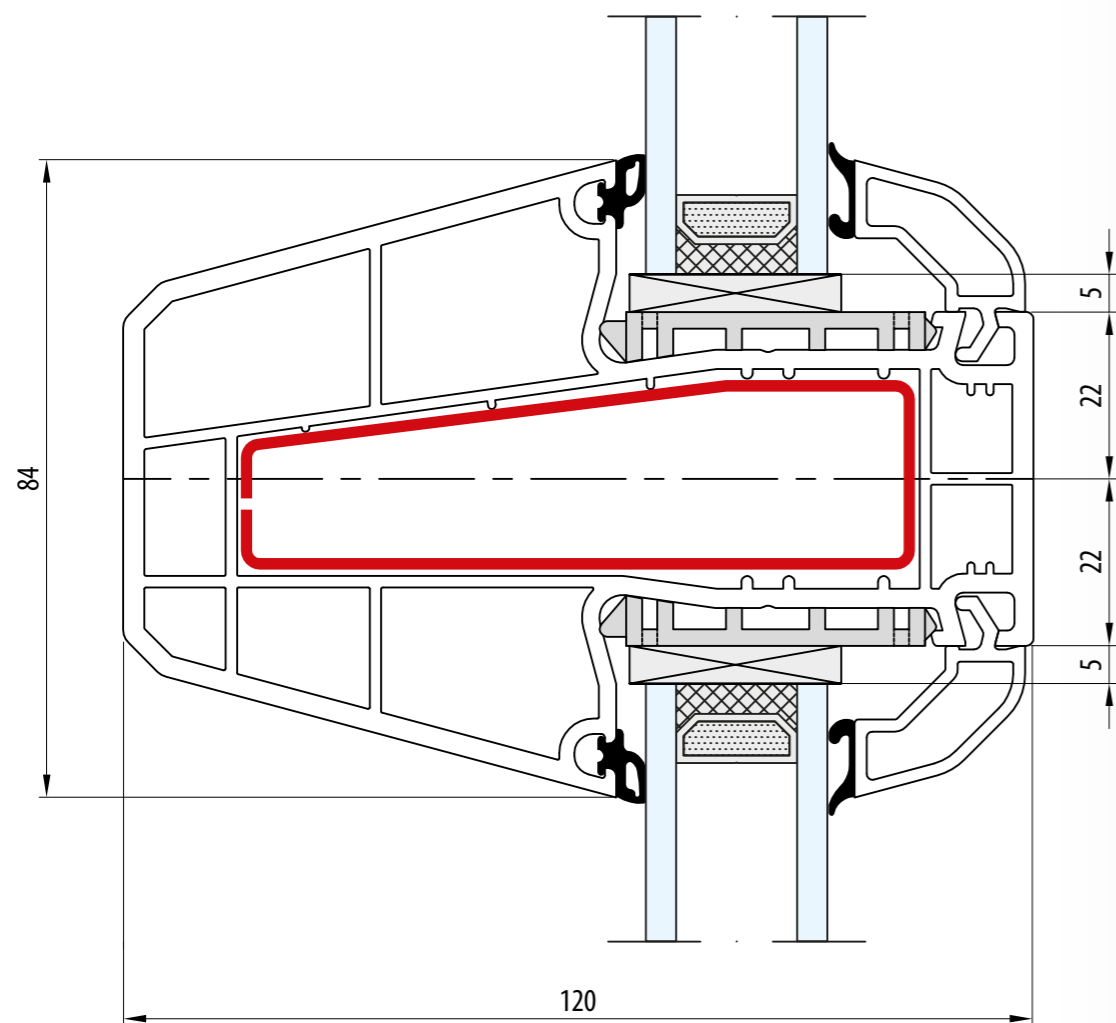





- Rama: 88 mm · Skrzydło: 120 mm
- Dormant: 88 mm · Vantail: 120 mm
- Frame: 88 mm · Sash: 120 mm
- Rahmen: 88 mm · Flügel: 120 mm
- Telaio: 88 mm · Anta: 120 mm

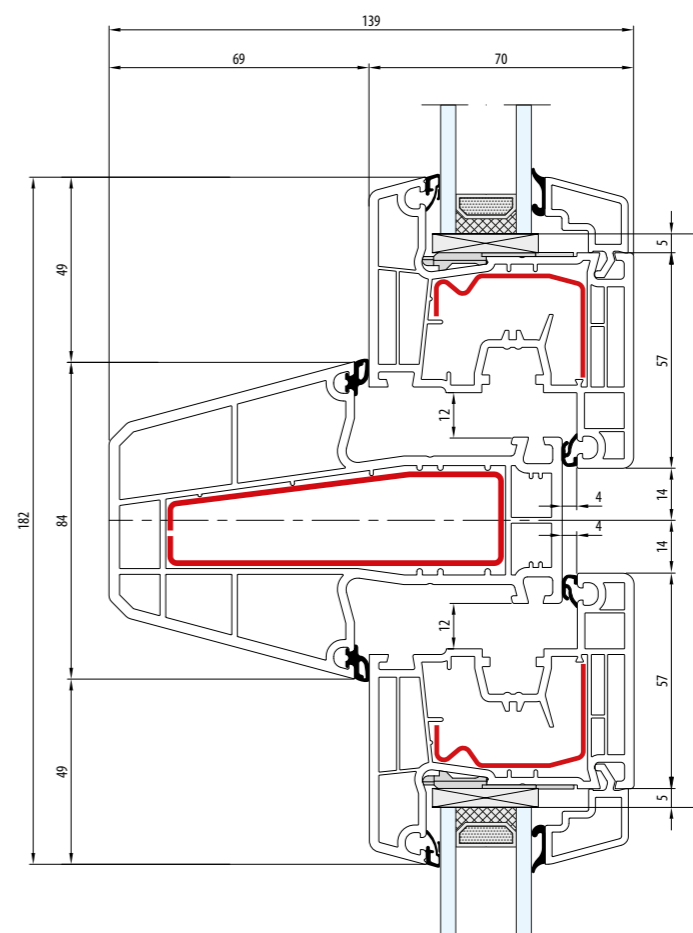
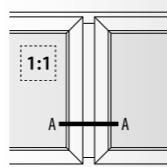





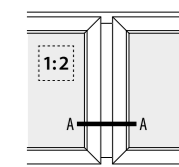

-  Słupek stalowy: 84 mm
-  Meneau fixe: 84 mm
-  Fix post: 84 mm
-  Festem Pfahl: 84 mm
-  Montante fissa: 84 mm

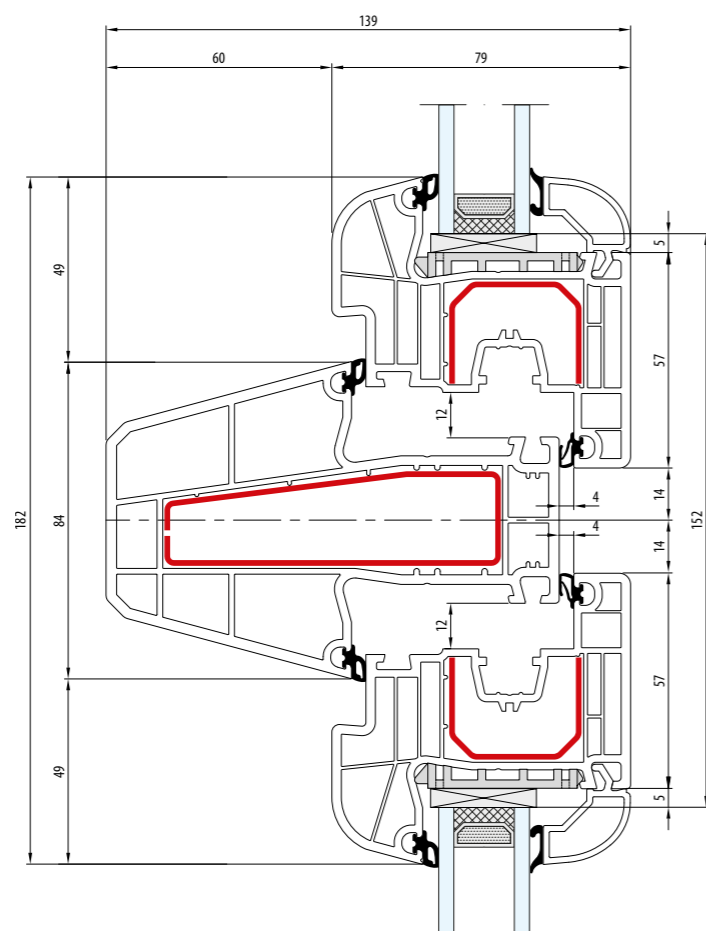





-  Słupek stalowy: 84 mm · Skrzydło: 77 mm
-  Meneau fixe: 84 mm · Vantail: 77 mm
-  Fix post: 84 mm · Sash: 77 mm
-  Festem Pfahl: 84 mm · Flügel: 77 mm
-  Montante fissa: 84 mm · Anta: 77 mm



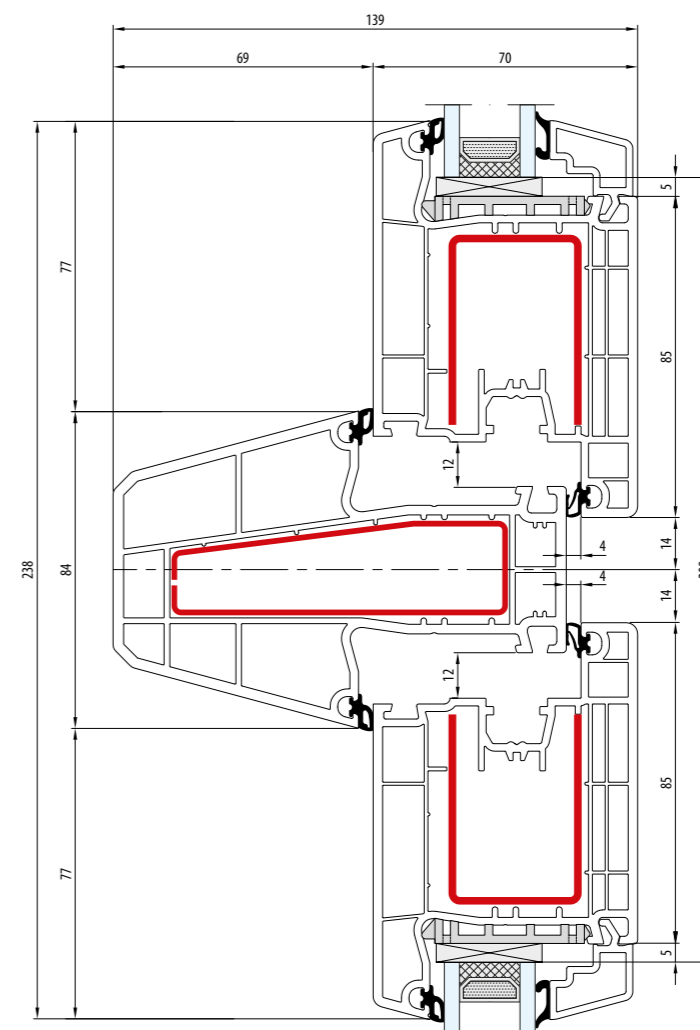
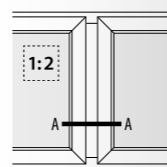

-  Słupek stalowy: 84 mm · Skrzydło: 77 mm
-  Meneau fixe: 84 mm · Vantail: 77 mm
-  Fix post: 84 mm · Sash: 77 mm
-  Festem Pfahl: 84 mm · Flügel: 77 mm
-  Montante fisso: 84 mm · Anta: 77 mm



-  Słupek stalowy: 84 mm · Skrzydło: 105 mm
-  Meneau fixe: 84 mm · Vantail: 105 mm
-  Fix post: 84 mm · Sash: 105 mm
-  Festem Pfahl: 84 mm · Flügel: 105 mm
-  Montante fisso: 84 mm · Anta: 105 mm

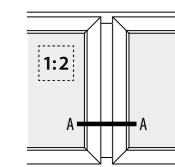

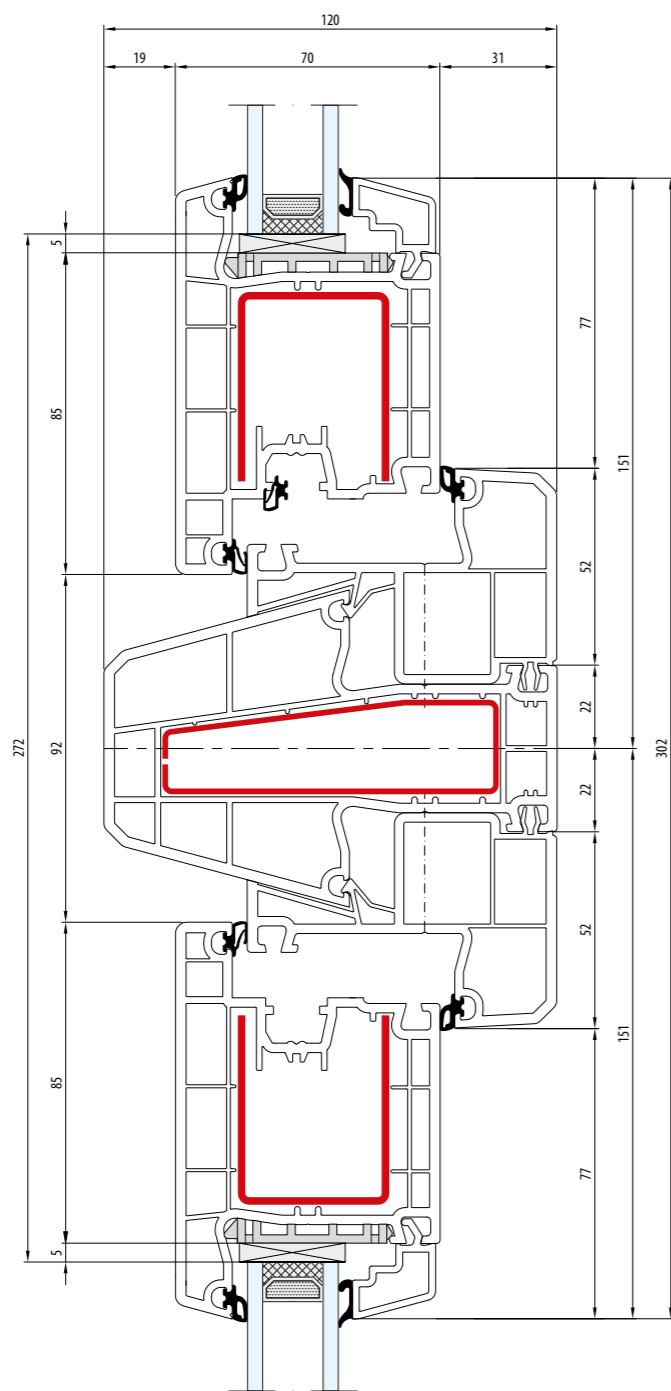

- Słupek stały: 84 mm · Skrzydło: 105 mm
- Meneau fixe: 84 mm · Vantail: 105 mm
- Fix post: 84 mm · Sash: 105 mm
- Festem Pfahl: 84 mm · Flügel: 105 mm
- Montante fisso: 84 mm · Anta: 105 mm

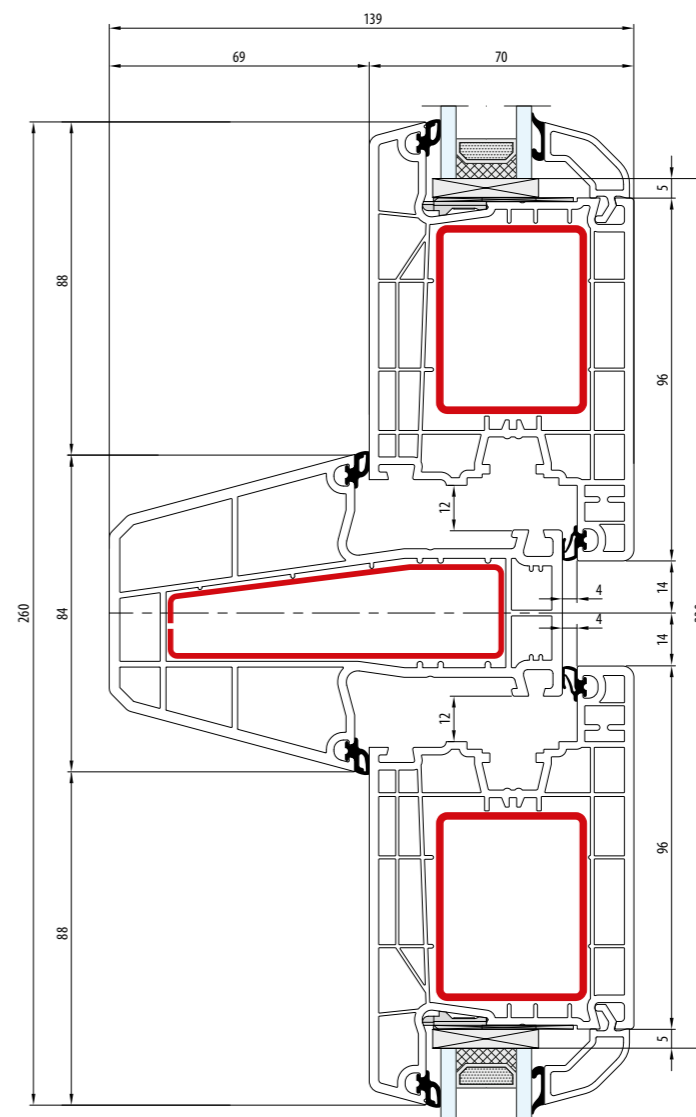
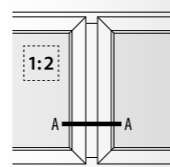

- Słupek stały: 84 mm · Skrzydło: 116 mm
- Meneau fixe: 84 mm · Vantail: 116 mm
- Fix post: 84 mm · Sash: 116 mm
- Festem Pfahl: 84 mm · Flügel: 116 mm
- Montante fisso: 84 mm · Anta: 116 mm

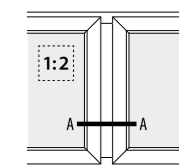

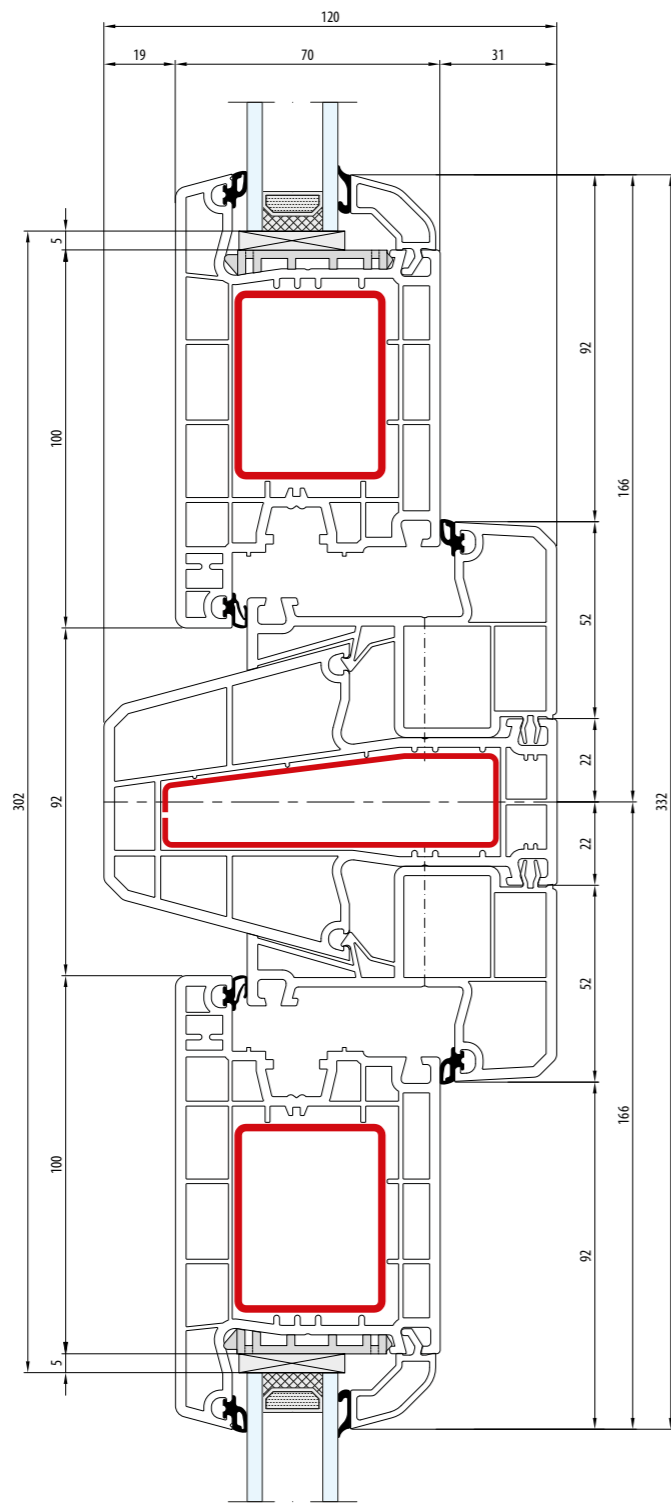

- Słupek stały: 84 mm · Skrzydło: 120 mm
- Meneau fixe: 84 mm · Vantail: 120 mm
- Fix post: 84 mm · Sash: 120 mm
- Festem Pfahl: 84 mm · Flügel: 120 mm
- Montante fisso: 84 mm · Anta: 120 mm

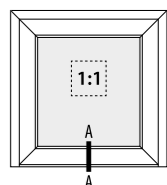
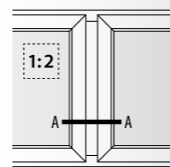

1:1

A

A

1:1

A

A

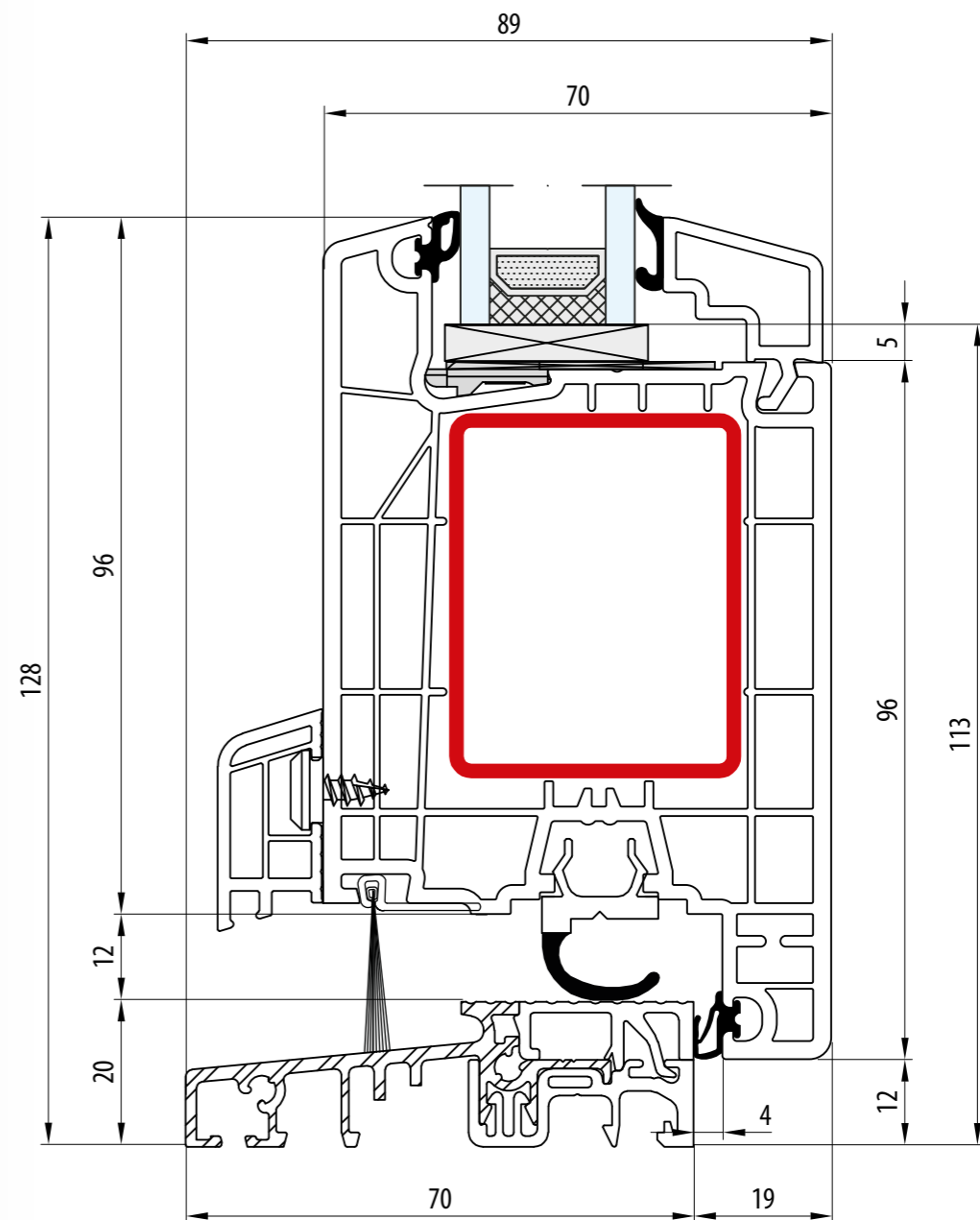

- Próg: 20 mm · Skrzydło: 116 mm
- Seuil: 20 mm · Vantail: 116 mm
- Threshold: 20 mm · Sash: 116 mm
- Schwelle: 20 mm · Flügel: 116 mm
- Soglia: 20 mm · Anta: 116 mm

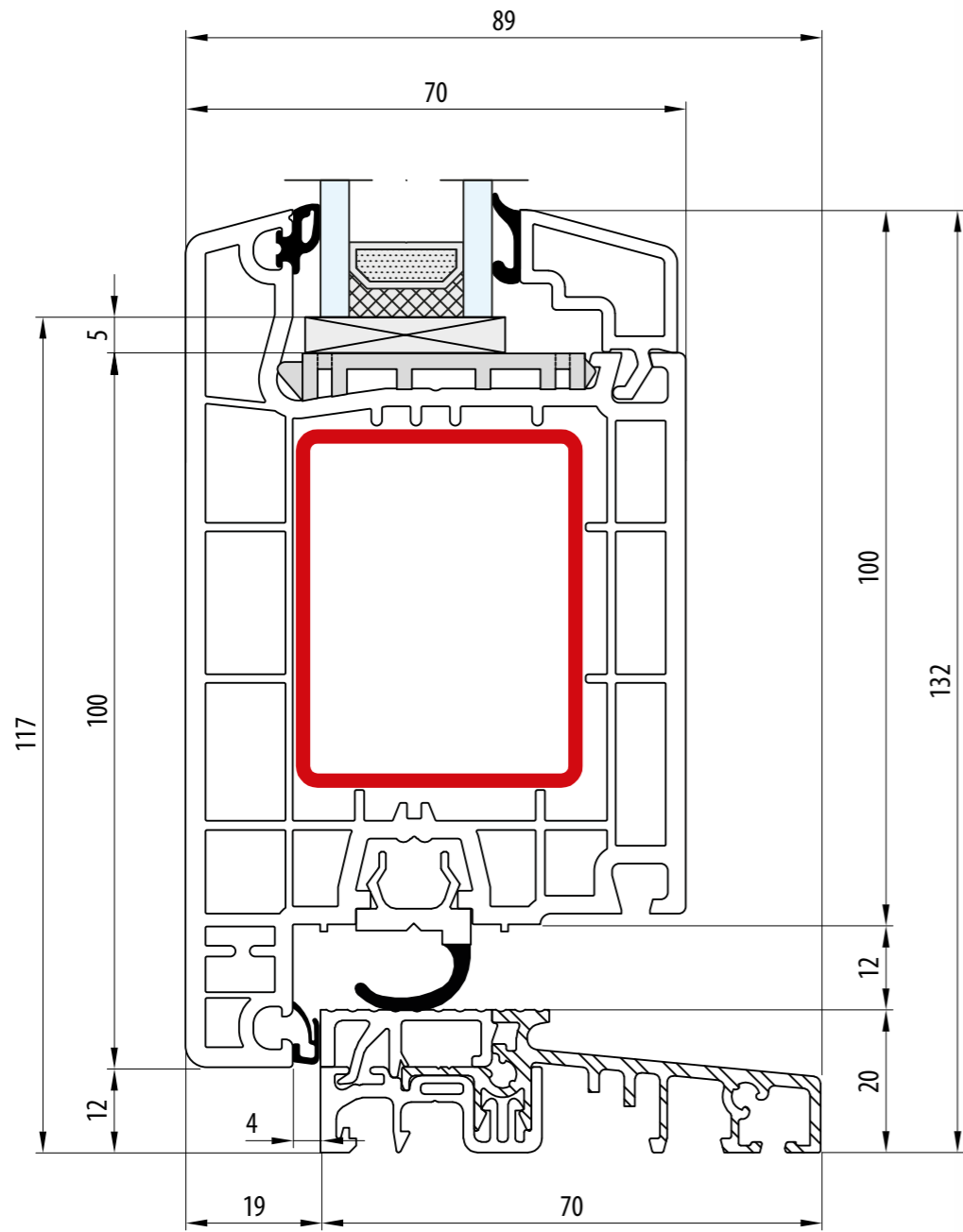

- Próg: 20 mm · Skrzydło: 120 mm
- Seuil: 20 mm · Vantail: 120 mm
- Threshold: 20 mm · Sash: 120 mm
- Schwelle: 20 mm · Flügel: 120 mm
- Soglia: 20 mm · Anta: 120 mm

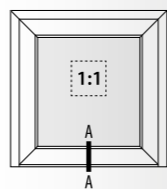

MONOBLOCK

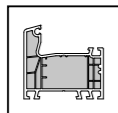

5



2

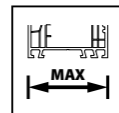

162

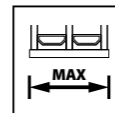

42

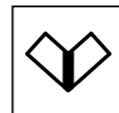

V SUPER SOLUTION

1:2



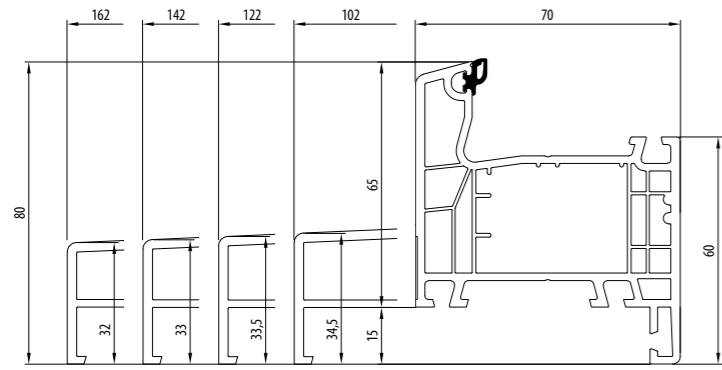

140x19 | 140x18 | 140x16 | 140x14 | 140x12

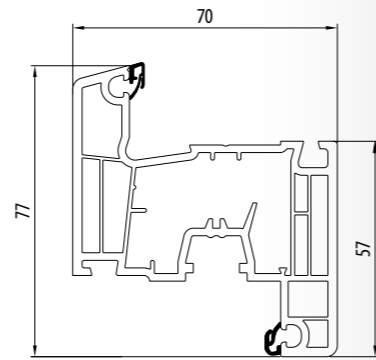

140x20

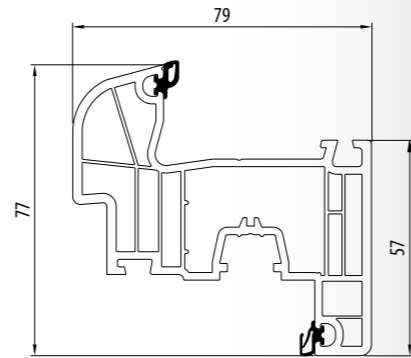

140x22

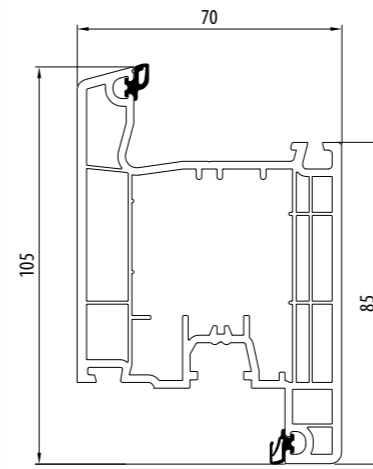

140x30

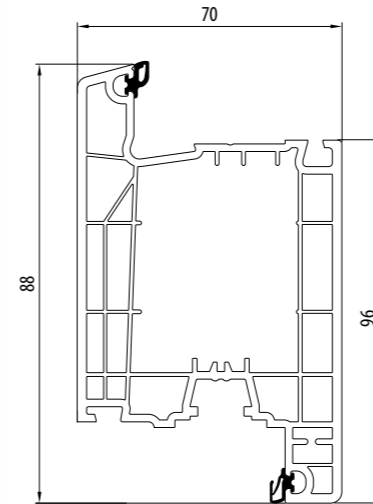

140x33

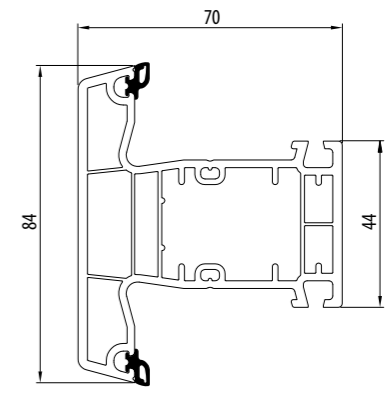

140x41

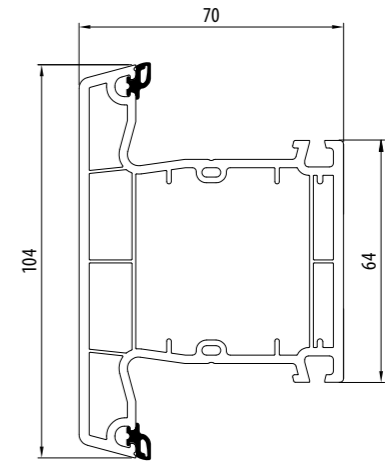

140x45

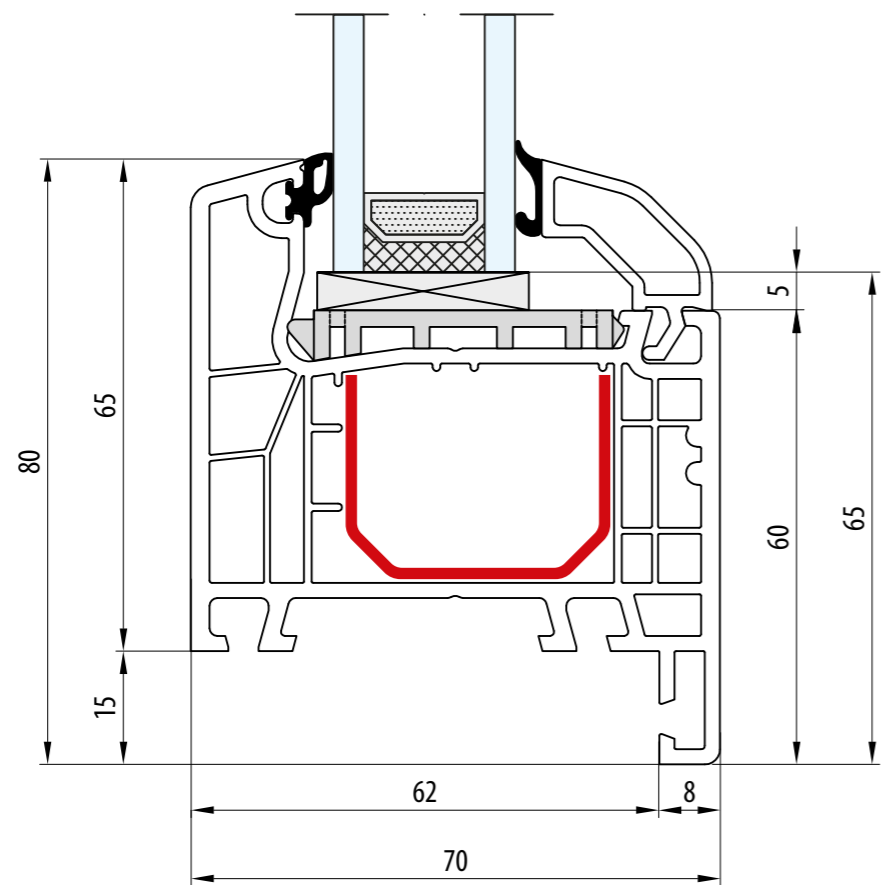

- MONOBLOCK - 70 mm · Rama: 80 mm
- MONOBLOC - 70 mm · Dormant: 80 mm
- MONOBLOK - 70 mm · Frame: 80 mm
- MONOBLOCK - 70 mm · Rahmen: 80 mm
- MONOBLOCK - 70 mm · Telaio: 80 mm

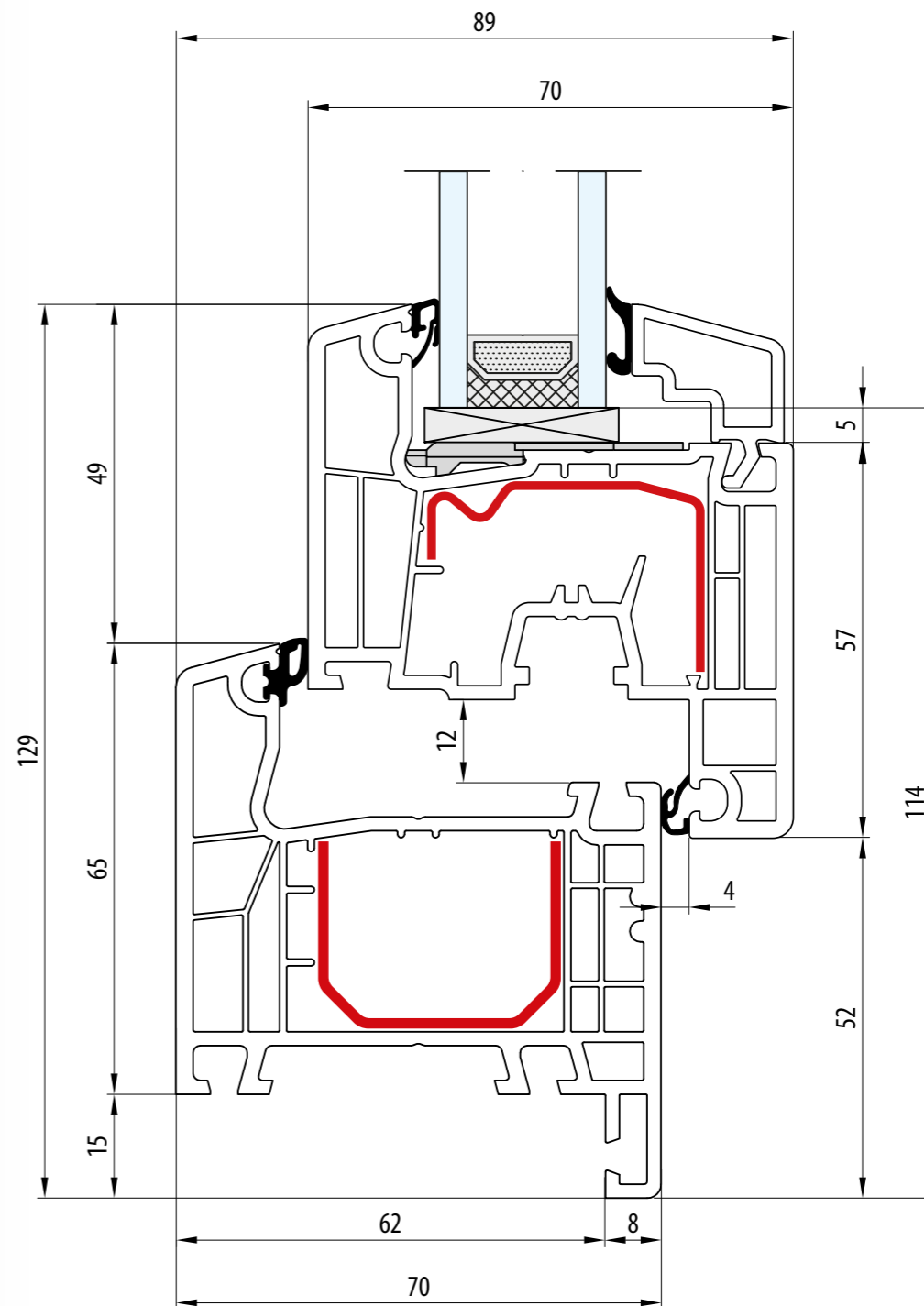
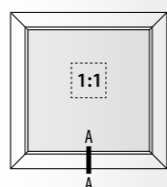

- MONOBLOCK - 70 mm · Rama: 80 mm · Skrzydło: 77 mm
- MONOBLOC - 70 mm · Dormant: 80 mm · Vantail: 77 mm
- MONOBLOK - 70 mm · Frame: 80 mm · Sash: 77 mm
- MONOBLOCK - 70 mm · Rahmen: 80 mm · Flügel: 77 mm
- MONOBLOCK - 70 mm · Telaio: 80 mm · Anta: 77 mm

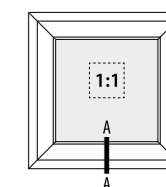

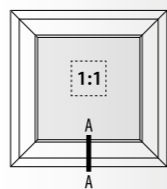
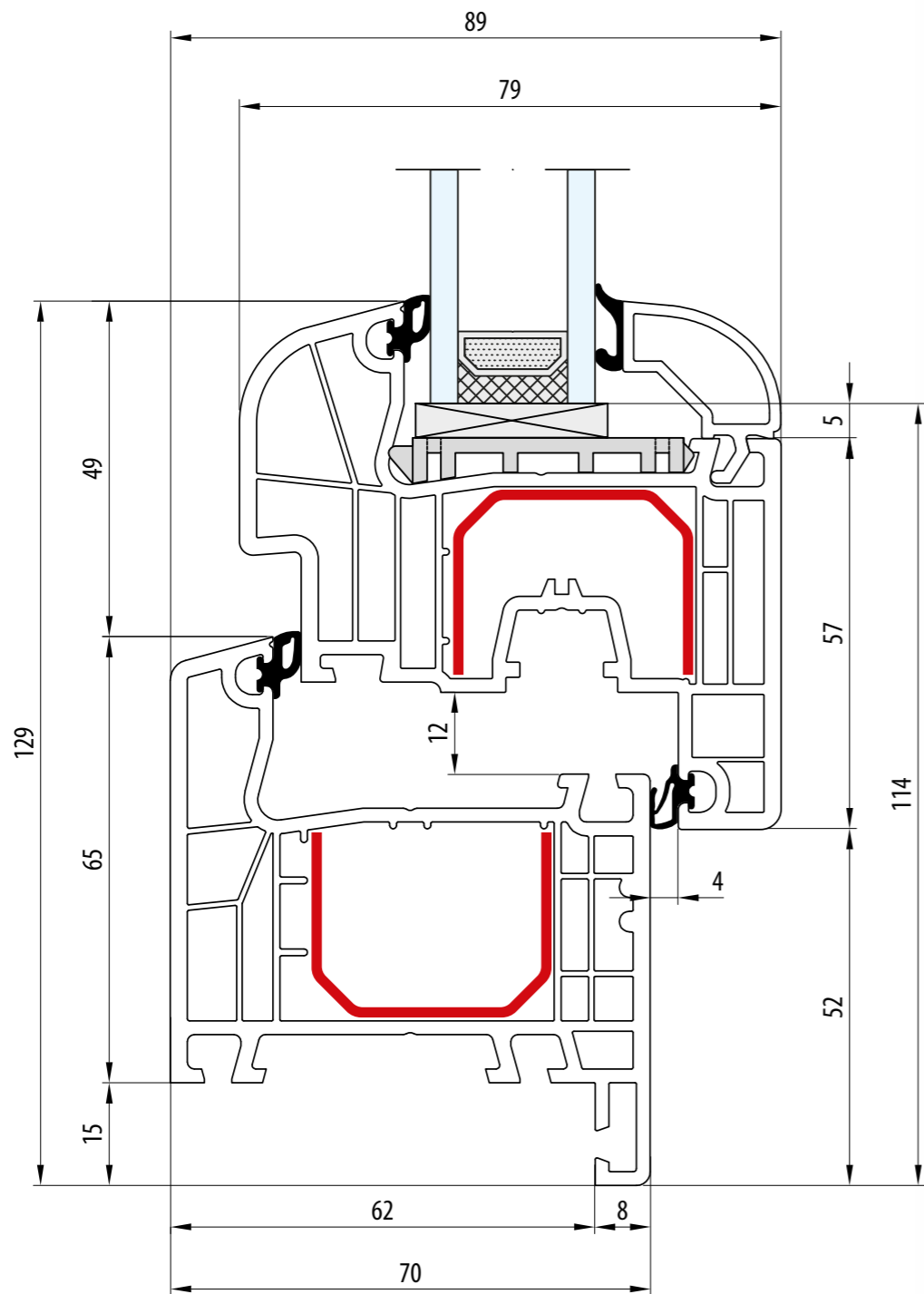

- MONOBLOCK - 70 mm · Rama: 80 mm · Skrzydło: 77 mm
- MONOBLOC - 70 mm · Dormant: 80 mm · Vantail: 77 mm
- MONOBLOK - 70 mm · Frame: 80 mm · Sash: 77 mm
- MONOBLOCK - 70 mm · Rahmen: 80 mm · Flügel: 77 mm
- MONOBLOCK - 70 mm · Telaio: 80 mm · Anta: 77 mm

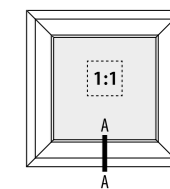
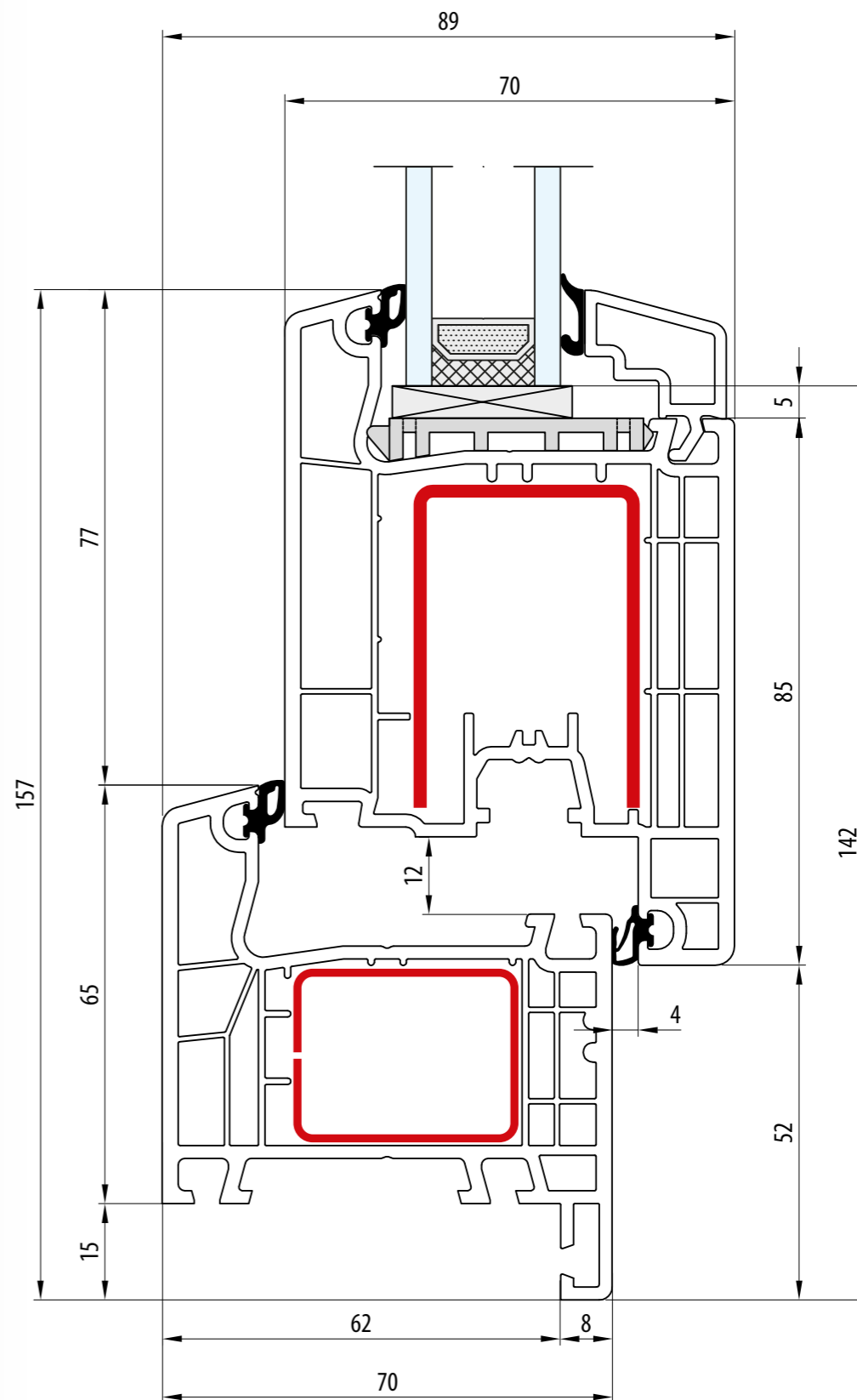

- MONOBLOCK - 70 mm · Rama: 80 mm · Skrzydło: 105 mm
- MONOBLOC - 70 mm · Dormant: 80 mm · Vantail: 105 mm
- MONOBLOK - 70 mm · Frame: 80 mm · Sash: 105 mm
- MONOBLOCK - 70 mm · Rahmen: 80 mm · Flügel: 105 mm
- MONOBLOCK - 70 mm · Telaio: 80 mm · Anta: 105 mm

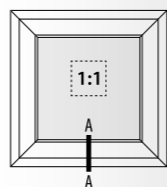
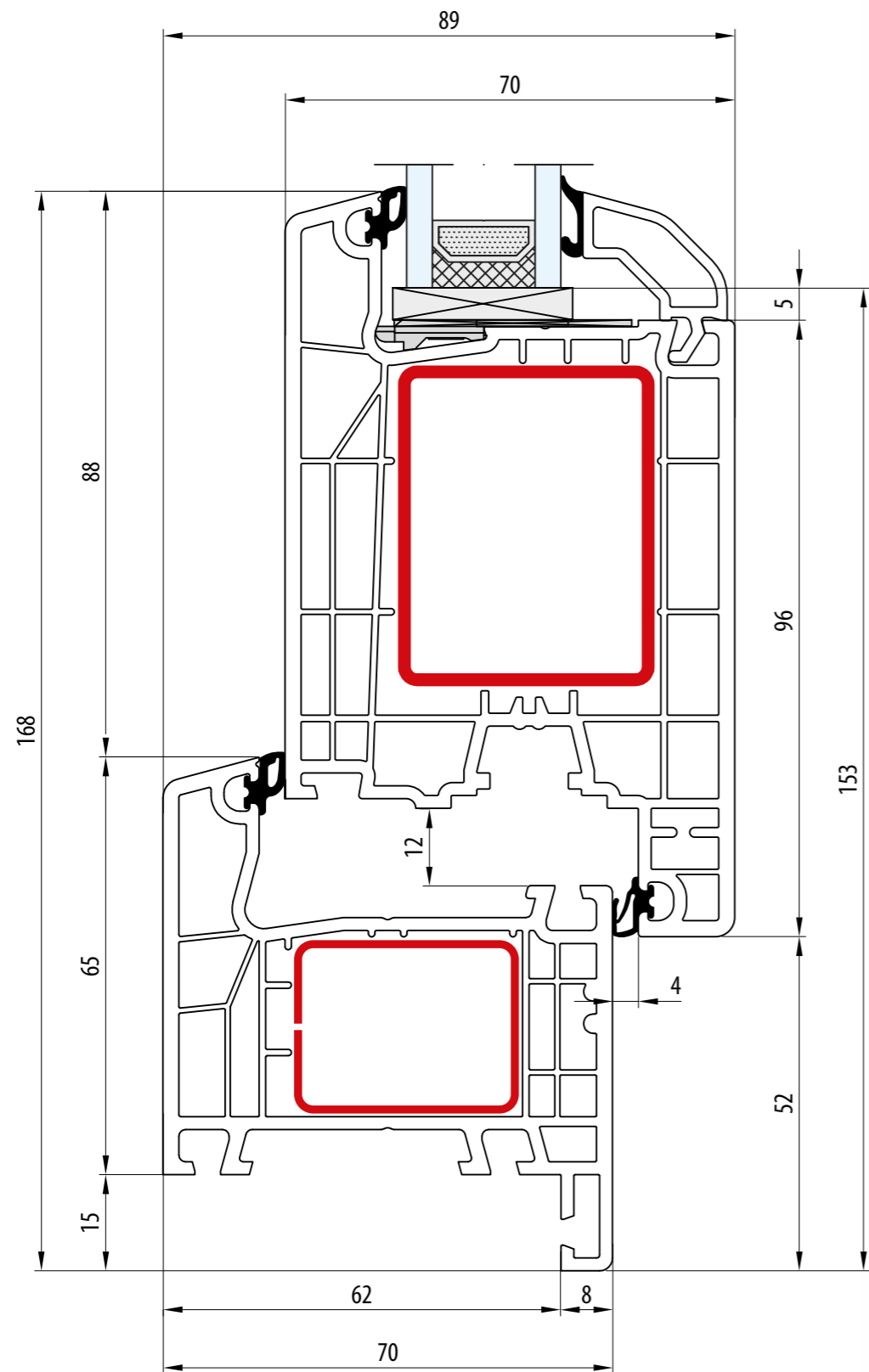



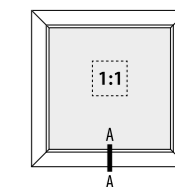
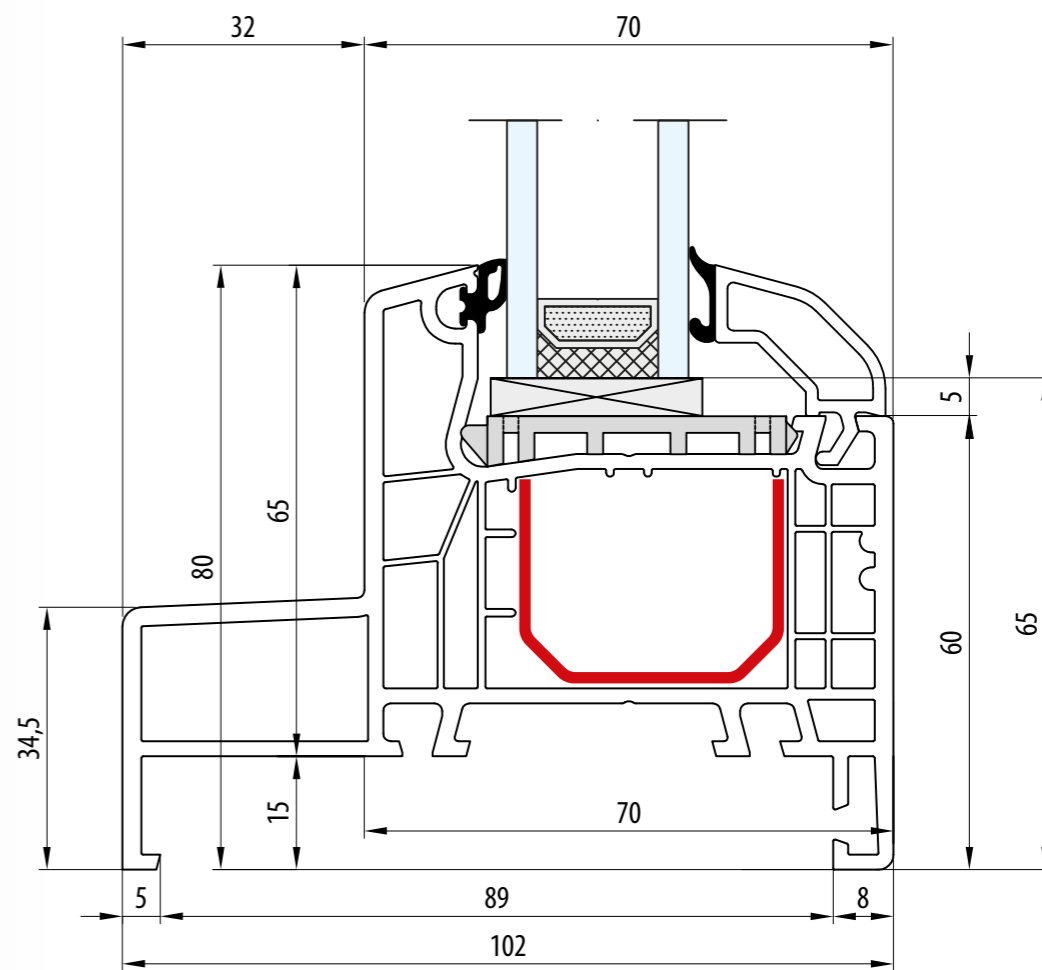

- MONOBLOCK - 70 mm · Rama: 80 mm · Skrzydło: 116 mm
- MONOBLOC - 70 mm · Dormant: 80 mm · Vantail: 116 mm
- MONOBLOK - 70 mm · Frame: 80 mm · Sash: 116 mm
- MONOBLOCK - 70 mm · Rahmen: 80 mm · Flügel: 116 mm
- MONOBLOCK - 70 mm · Telaio: 80 mm · Anta: 116 mm

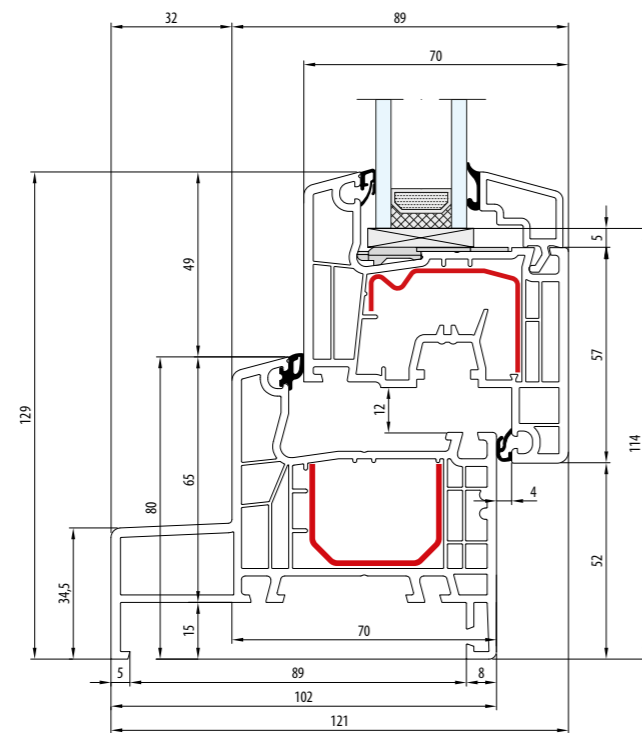

- MONOBLOCK - 100 mm · Rama: 80 mm
- MONOBLOC - 100 mm · Dormant: 80 mm
- MONOBLOK - 100 mm · Frame: 80 mm
- MONOBLOCK - 100 mm · Rahmen: 80 mm
- MONOBLOCK - 100 mm · Telaio: 80 mm



-  MONOBLOCK - 100 mm · Rama: 80 mm · Skrzydło: 77 mm
-  MONOBLOC - 100 mm · Dormant: 80 mm · Vantail: 77 mm
-  MONOBLOCK - 100 mm · Frame: 80 mm · Sash: 77 mm
-  MONOBLOCK - 100 mm · Rahmen: 80 mm · Flügel: 77 mm
-  MONOBLOCK - 100 mm · Telaio: 80 mm · Anta: 77 mm

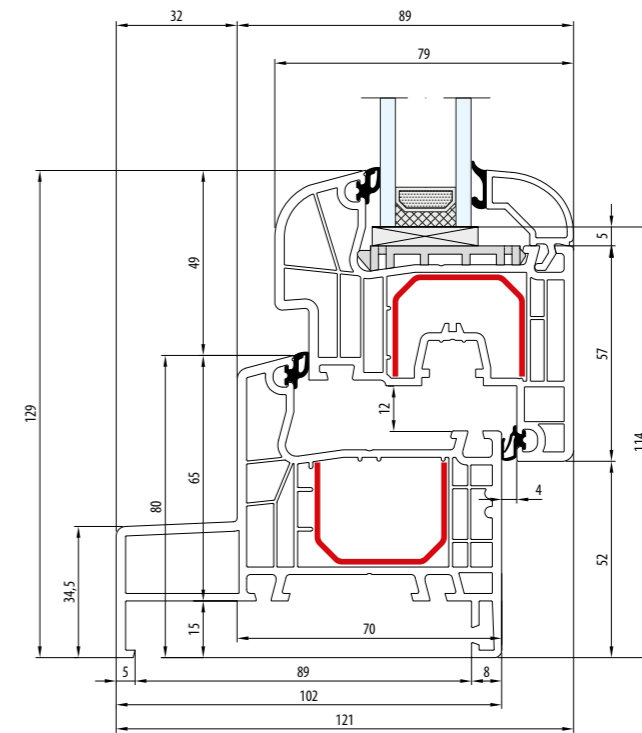
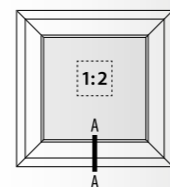

-  MONOBLOCK - 100 mm · Rama: 80 mm · Skrzydło: 77 mm
-  MONOBLOC - 100 mm · Dormant: 80 mm · Vantail: 77 mm
-  MONOBLOCK - 100 mm · Frame: 80 mm · Sash: 77 mm
-  MONOBLOCK - 100 mm · Rahmen: 80 mm · Flügel: 77 mm
-  MONOBLOCK - 100 mm · Telaio: 80 mm · Anta: 77 mm

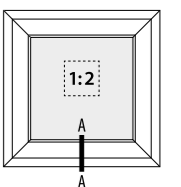

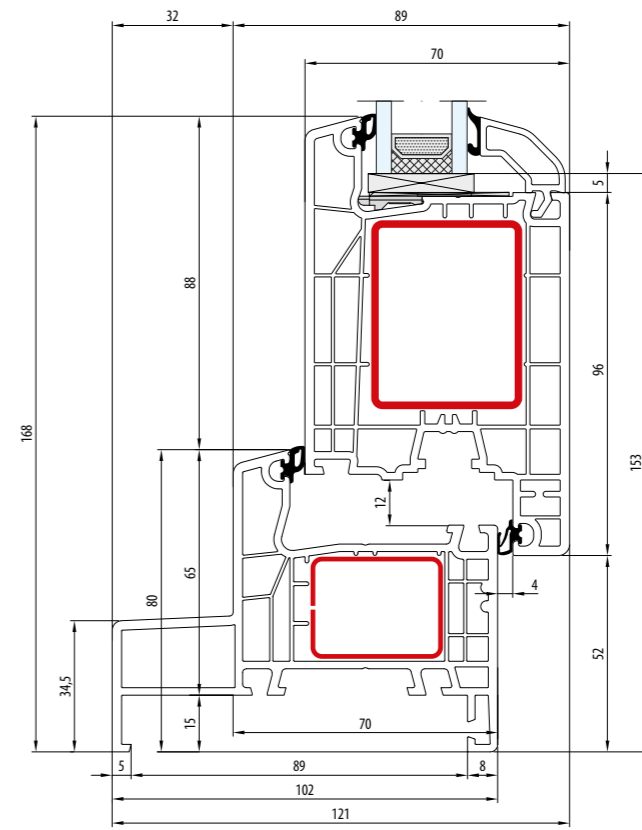
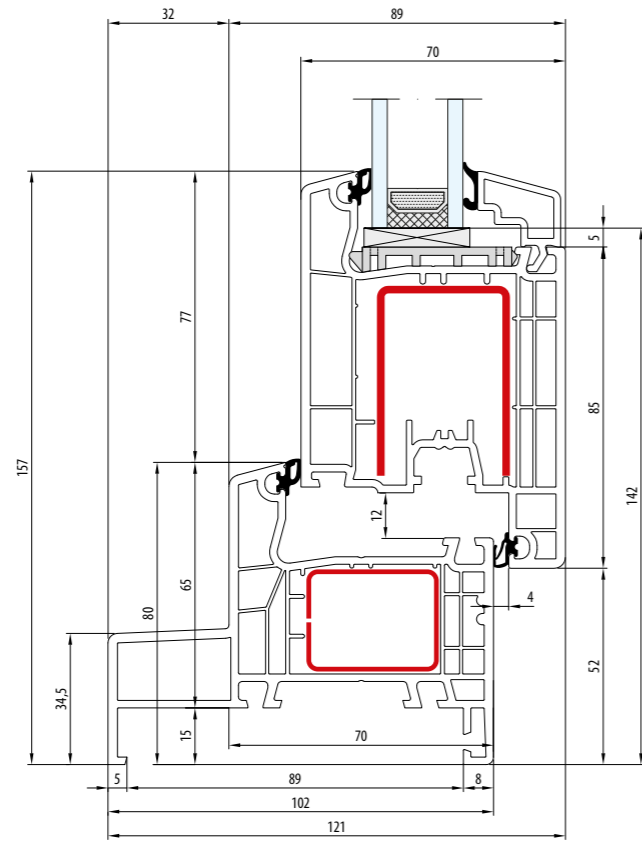

- MONOBLOCK - 100 mm · Rama: 80 mm · Skrzydło: 105 mm
- MONOBLOC - 100 mm · Dormant: 80 mm · Vantail: 105 mm
- MONOBLOK - 100 mm · Frame: 80 mm · Sash: 105 mm
- MONOBLOCK - 100 mm · Rahmen: 80 mm · Flügel: 105 mm
- MONOBLOCK - 100 mm · Telaio: 80 mm · Anta: 105 mm

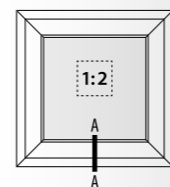

- MONOBLOCK - 100 mm · Rama: 80 mm · Skrzydło: 116 mm
- MONOBLOC - 100 mm · Dormant: 80 mm · Vantail: 116 mm
- MONOBLOK - 100 mm · Frame: 80 mm · Sash: 116 mm
- MONOBLOCK - 100 mm · Rahmen: 80 mm · Flügel: 116 mm
- MONOBLOCK - 100 mm · Telaio: 80 mm · Anta: 116 mm

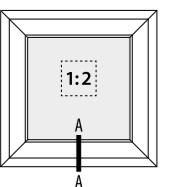

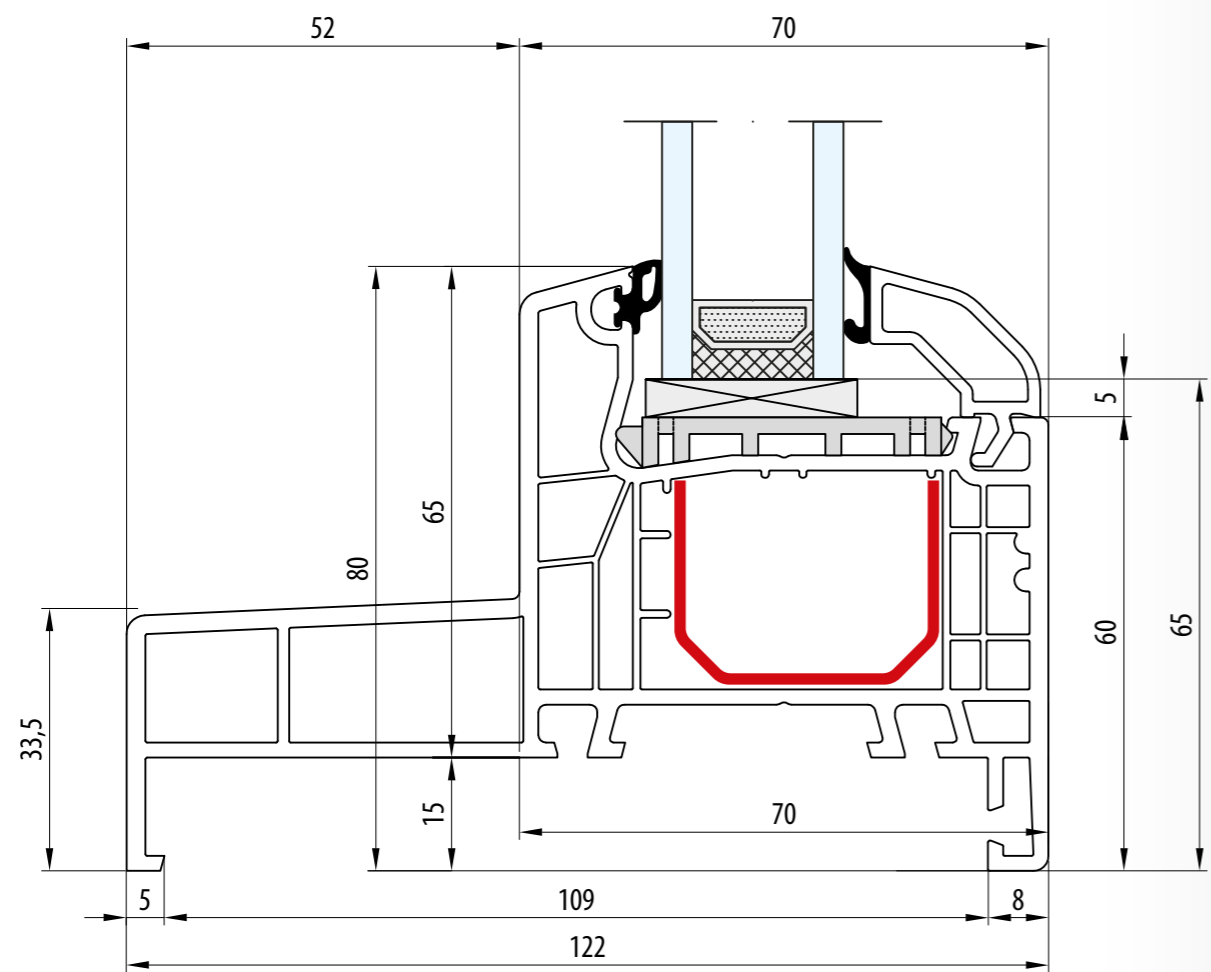

- MONOBLOCK - 120 mm · Rama: 80 mm
- MONOBLOC - 120 mm · Dormant: 80 mm
- MONOBLOK - 120 mm · Frame: 80 mm
- MONOBLOCK - 120 mm · Rahmen: 80 mm
- MONOBLOCK - 120 mm · Telaio: 80 mm

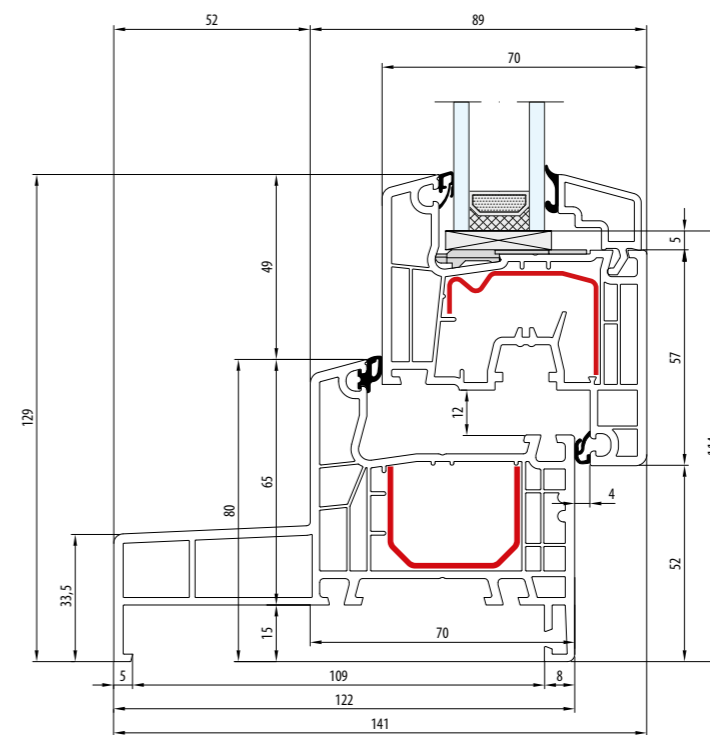
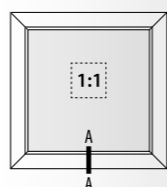

- MONOBLOCK - 120 mm · Rama: 80 mm · Skrzydło: 77 mm
- MONOBLOC - 120 mm · Dormant: 80 mm · Vantail: 77 mm
- MONOBLOK - 120 mm · Frame: 80 mm · Sash: 77 mm
- MONOBLOCK - 120 mm · Rahmen: 80 mm · Flügel: 77 mm
- MONOBLOCK - 120 mm · Telaio: 80 mm · Anta: 77 mm

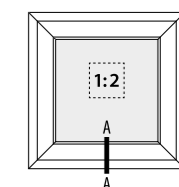

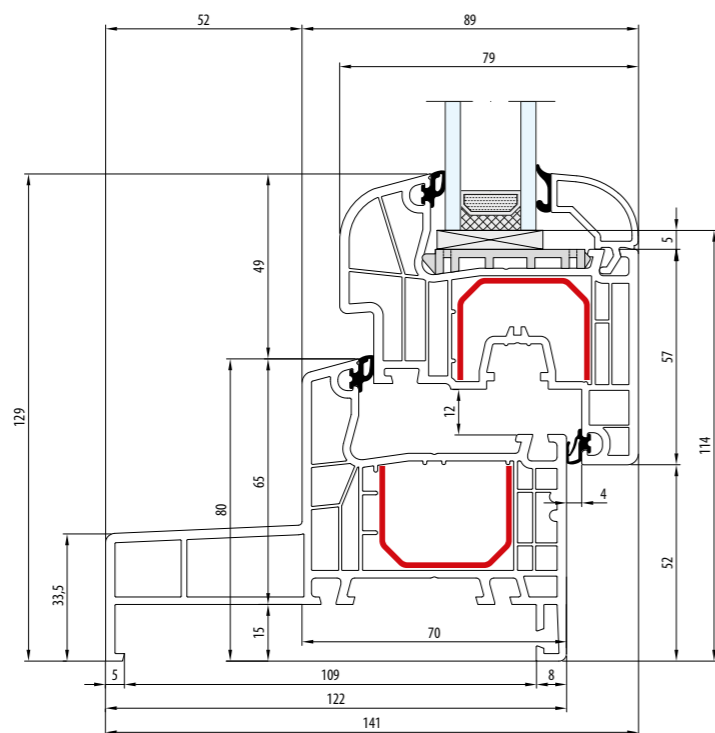

- MONOBLOCK - 120 mm · Rama: 80 mm · Skrzydło: 77 mm
- MONOBLOC - 120 mm · Dormant: 80 mm · Vantail: 77 mm
- MONOBLOK - 120 mm · Frame: 80 mm · Sash: 77 mm
- MONOBLOCK - 120 mm · Rahmen: 80 mm · Flügel: 77 mm
- MONOBLOCK - 120 mm · Telaio: 80 mm · Anta: 77 mm

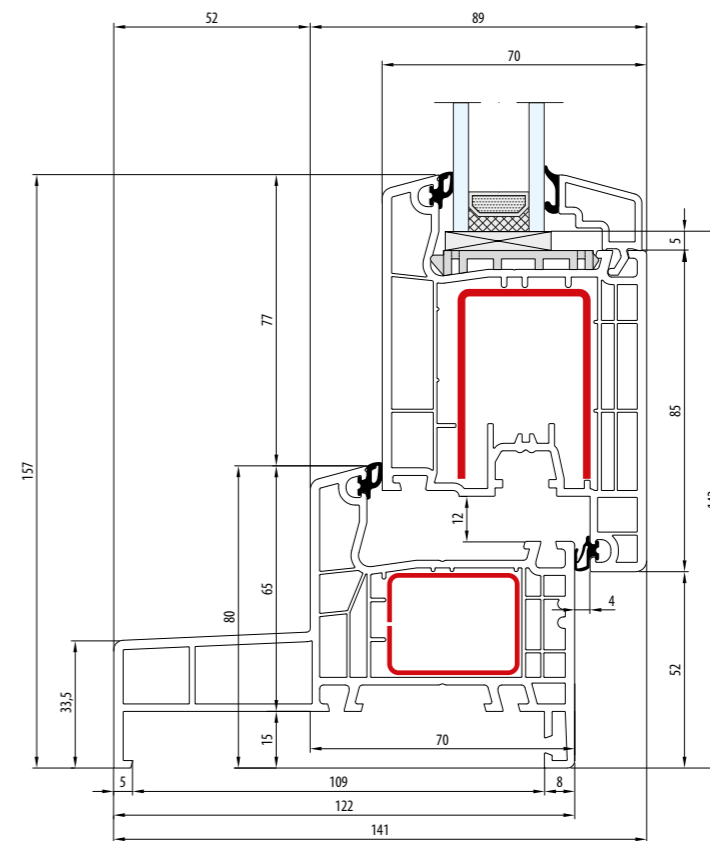
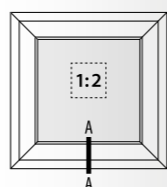

- MONOBLOCK - 120 mm · Rama: 80 mm · Skrzydło: 105 mm
- MONOBLOC - 120 mm · Dormant: 80 mm · Vantail: 105 mm
- MONOBLOK - 120 mm · Frame: 80 mm · Sash: 105 mm
- MONOBLOCK - 120 mm · Rahmen: 80 mm · Flügel: 105 mm
- MONOBLOCK - 120 mm · Telaio: 80 mm · Anta: 105 mm

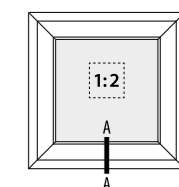

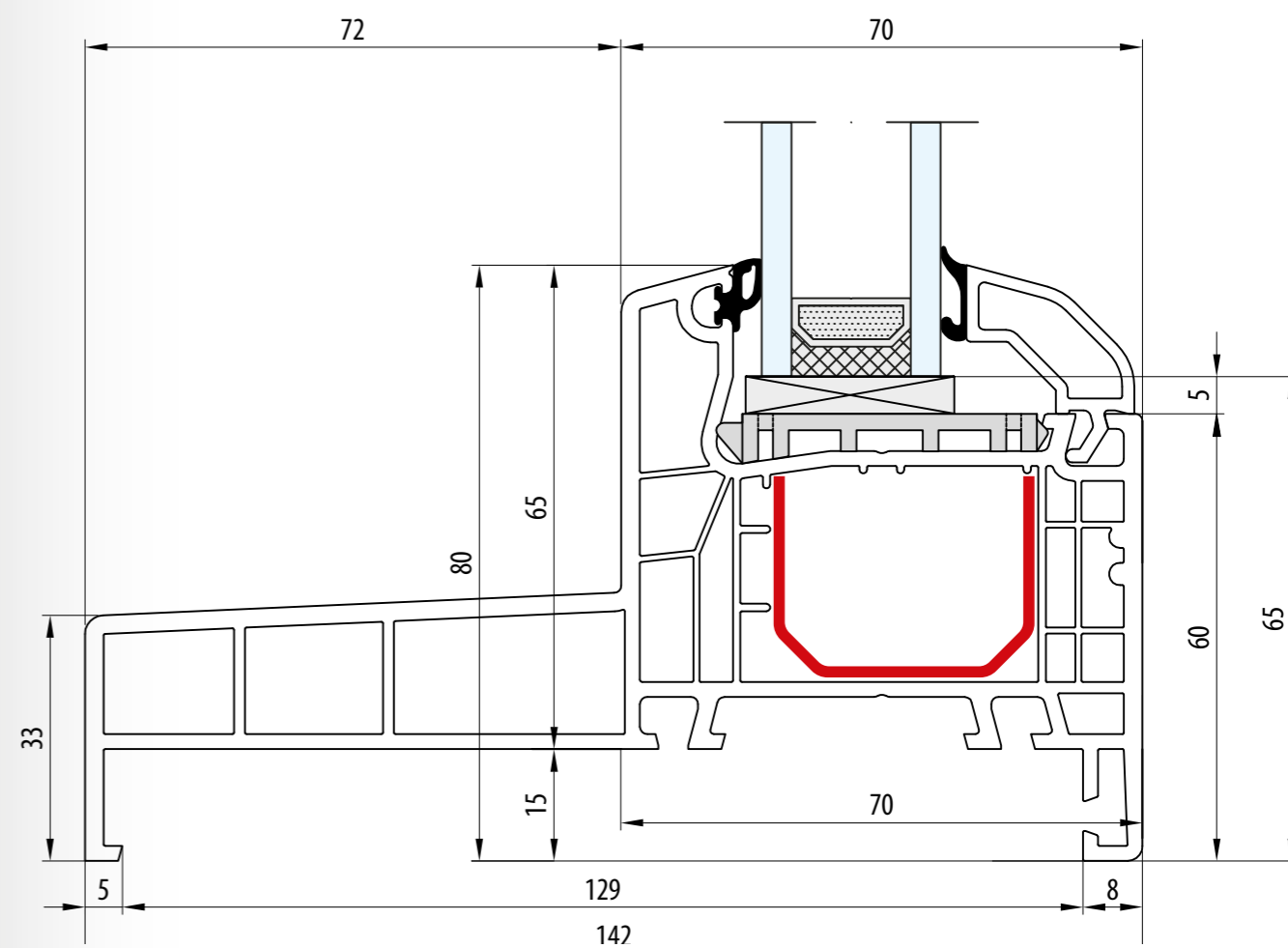
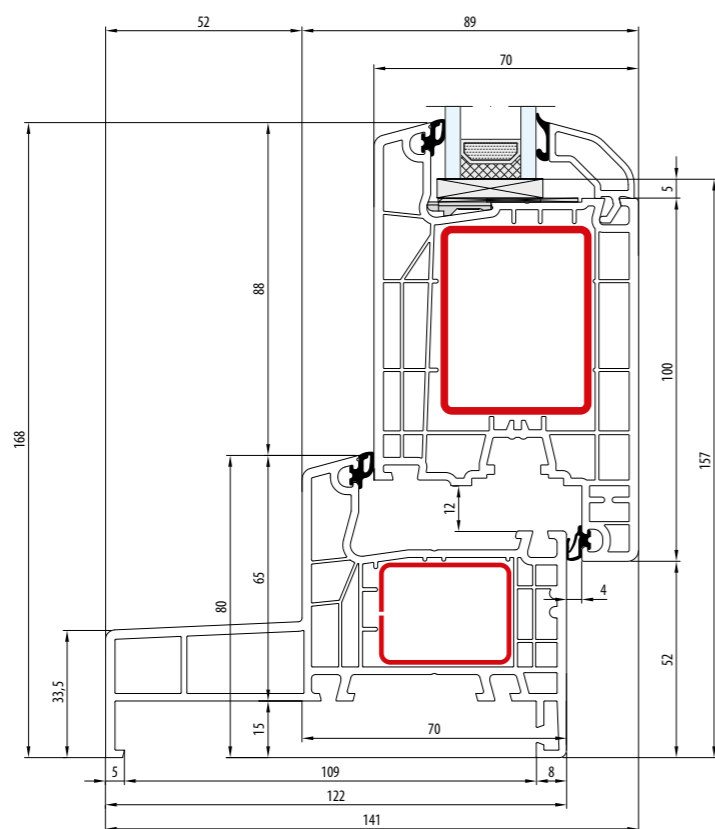

- MONOBLOCK - 120 mm · Rama: 80 mm · Skrzydło: 116 mm
- MONOBLOC - 120 mm · Dormant: 80 mm · Vantail: 116 mm
- MONOBLOK - 120 mm · Frame: 80 mm · Sash: 116 mm
- MONOBLOCK - 120 mm · Rahmen: 80 mm · Flügel: 116 mm
- MONOBLOCK - 120 mm · Telaio: 80 mm · Anta: 116 mm

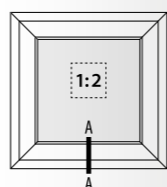

- MONOBLOCK - 140 mm · Rama: 80 mm
- MONOBLOC - 140 mm · Dormant: 80 mm
- MONOBLOK - 140 mm · Frame: 80 mm
- MONOBLOCK - 140 mm · Rahmen: 80 mm
- MONOBLOCK - 140 mm · Telaio: 80 mm

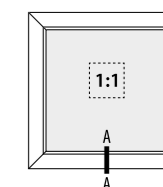

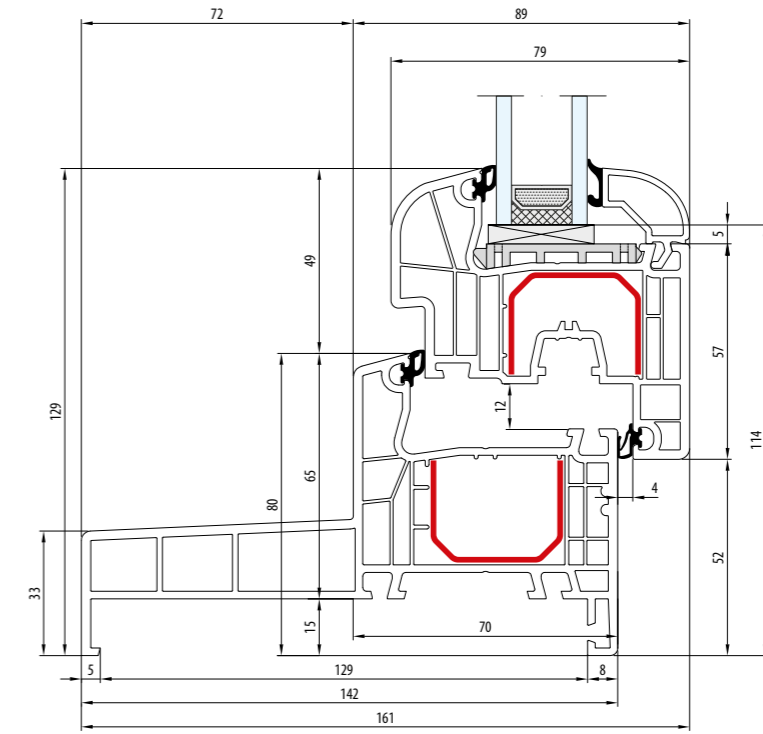
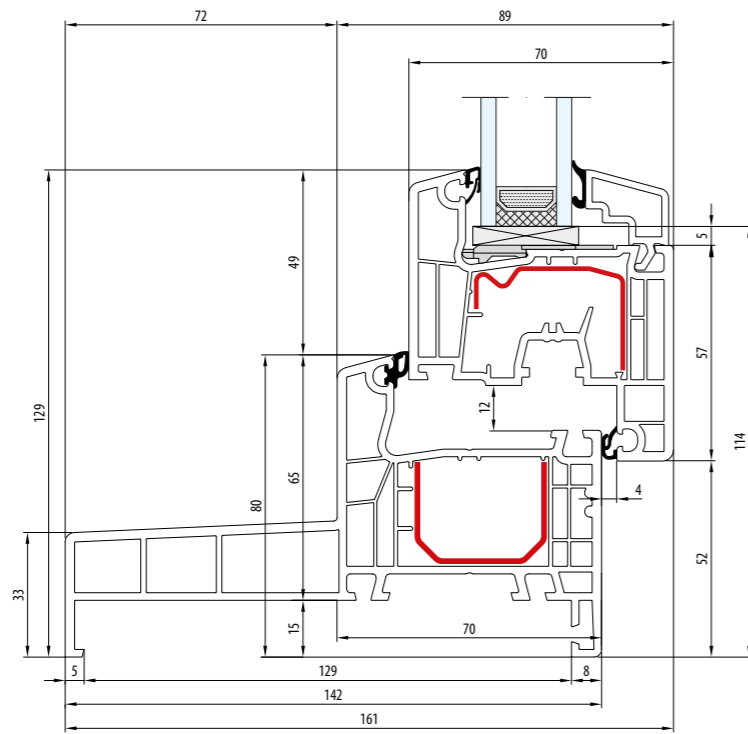

- MONOBLOCK - 140 mm · Rama: 80 mm · Skrzydło: 77 mm
- MONOBLOC - 140 mm · Dormant: 80 mm · Vantail: 77 mm
- MONOBLOCK - 140 mm · Frame: 80 mm · Sash: 77 mm
- MONOBLOCK - 140 mm · Rahmen: 80 mm · Flügel: 77 mm
- MONOBLOCK - 140 mm · Telaio: 80 mm · Anta: 77 mm

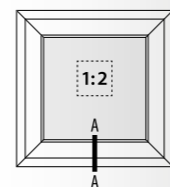

- MONOBLOCK - 140 mm · Rama: 80 mm · Skrzydło: 77 mm
- MONOBLOC - 140 mm · Dormant: 80 mm · Vantail: 77 mm
- MONOBLOCK - 140 mm · Frame: 80 mm · Sash: 77 mm
- MONOBLOCK - 140 mm · Rahmen: 80 mm · Flügel: 77 mm
- MONOBLOCK - 140 mm · Telaio: 80 mm · Anta: 77 mm

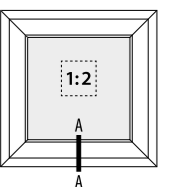

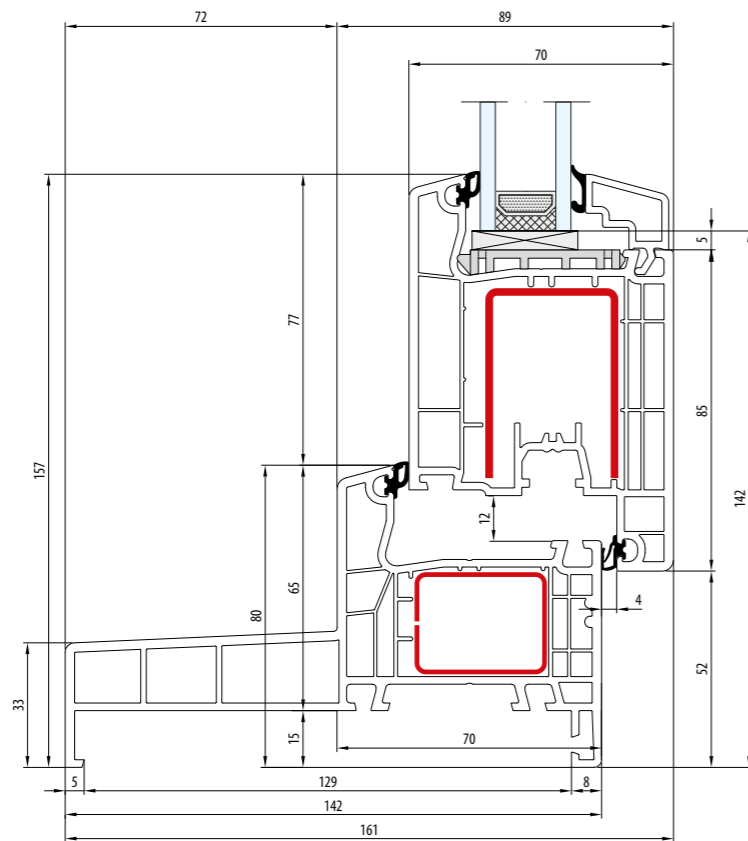

- MONOBLOCK - 140 mm · Rama: 80 mm · Skrzydło: 105 mm
- MONOBLOC - 140 mm · Dormant: 80 mm · Vantail: 105 mm
- MONOBLOK - 140 mm · Frame: 80 mm · Sash: 105 mm
- MONOBLOCK - 140 mm · Rahmen: 80 mm · Flügel: 105 mm
- MONOBLOCK - 140 mm · Telaio: 80 mm · Anta: 105 mm

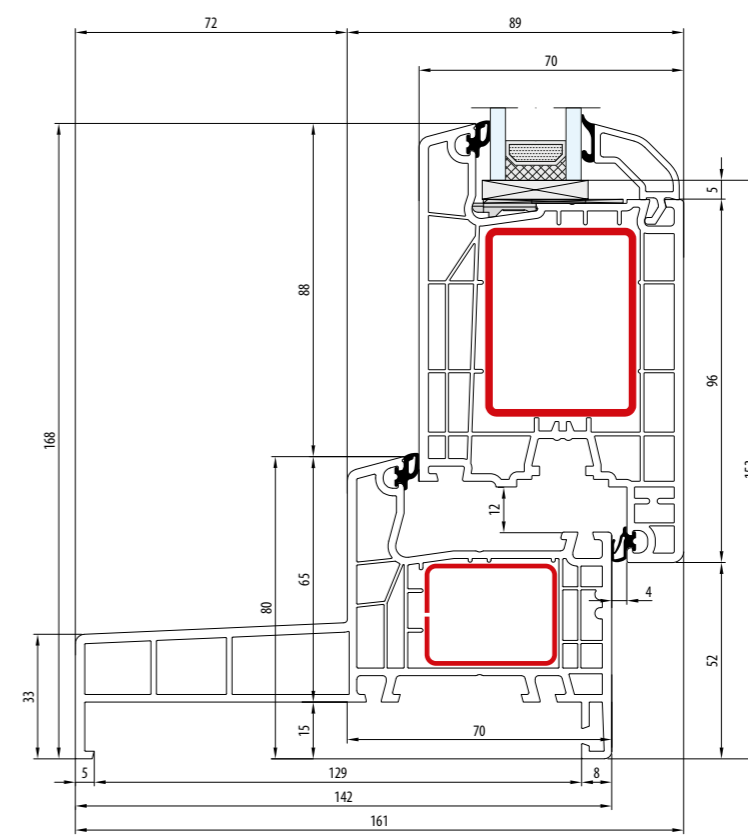
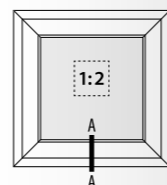

- MONOBLOCK - 140 mm · Rama: 80 mm · Skrzydło: 116 mm
- MONOBLOC - 140 mm · Dormant: 80 mm · Vantail: 116 mm
- MONOBLOK - 140 mm · Frame: 80 mm · Sash: 116 mm
- MONOBLOCK - 140 mm · Rahmen: 80 mm · Flügel: 116 mm
- MONOBLOCK - 140 mm · Telaio: 80 mm · Anta: 116 mm

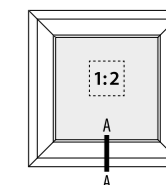

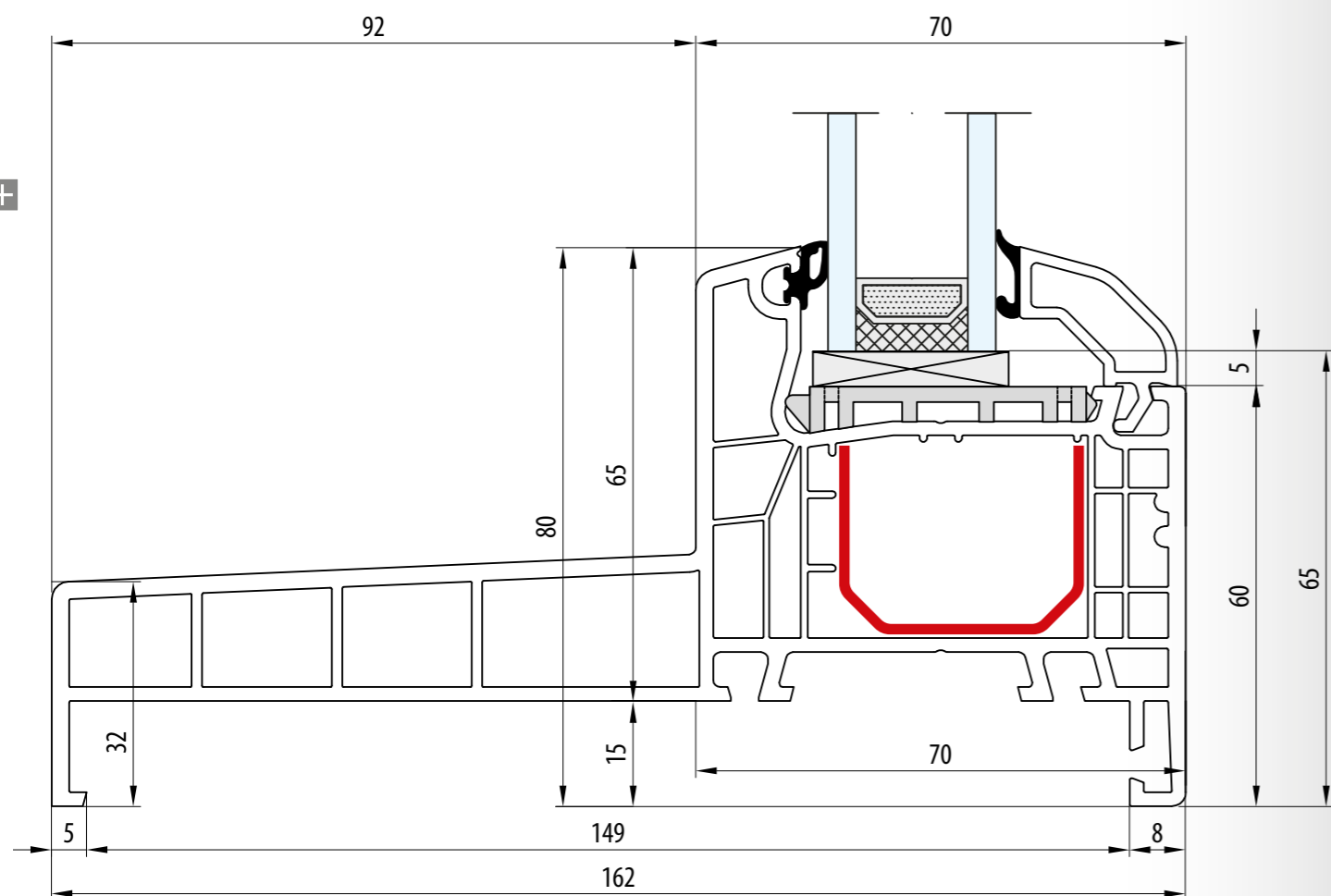

- MONOBLOCK - 160 mm · Rama: 80 mm
- MONOBLOC - 160 mm · Dormant: 80 mm
- MONOBLOK - 160 mm · Frame: 80 mm
- MONOBLOCK - 160 mm · Rahmen: 80 mm
- MONOBLOCK - 160 mm · Telaio: 80 mm

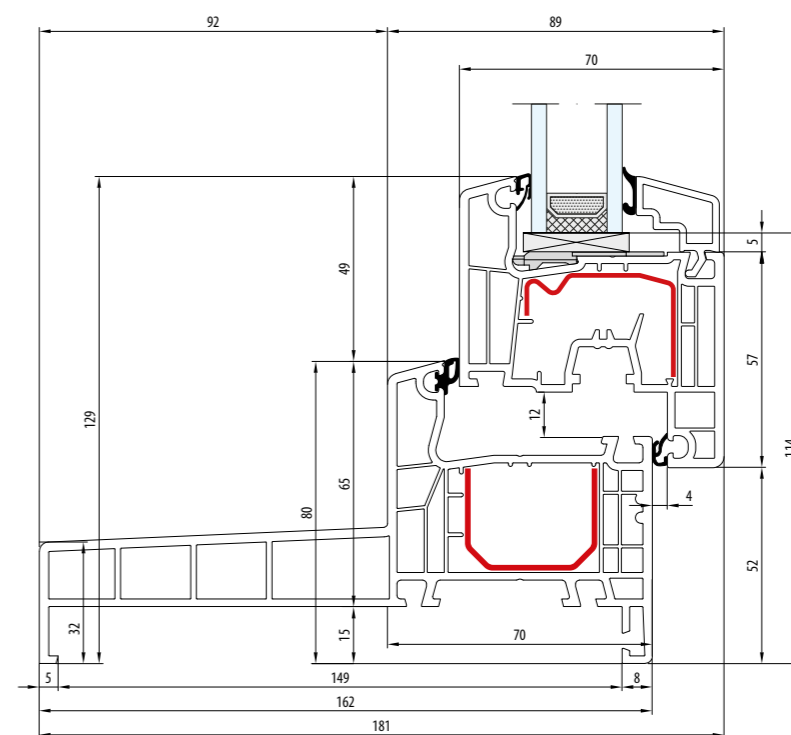
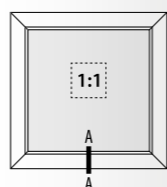

- MONOBLOCK - 160 mm · Rama: 80 mm · Skrzydło: 77 mm
- MONOBLOC - 160 mm · Dormant: 80 mm · Vantail: 77 mm
- MONOBLOK - 160 mm · Frame: 80 mm · Sash: 77 mm
- MONOBLOCK - 160 mm · Rahmen: 80 mm · Flügel: 77 mm
- MONOBLOCK - 160 mm · Telaio: 80 mm · Anta: 77 mm

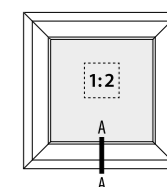

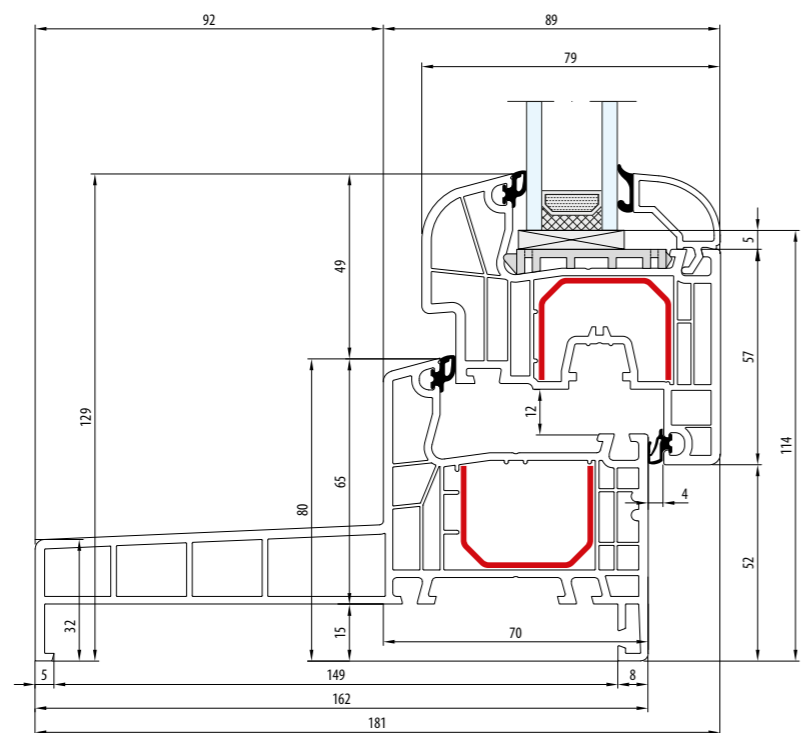

- MONOBLOCK - 160 mm · Rama: 80 mm · Skrzydło: 77 mm
- MONOBLOC - 160 mm · Dormant: 80 mm · Vantail: 77 mm
- MONOBLOK - 160 mm · Frame: 80 mm · Sash: 77 mm
- MONOBLOCK - 160 mm · Rahmen: 80 mm · Flügel: 77 mm
- MONOBLOCK - 160 mm · Telaio: 80 mm · Anta: 77 mm

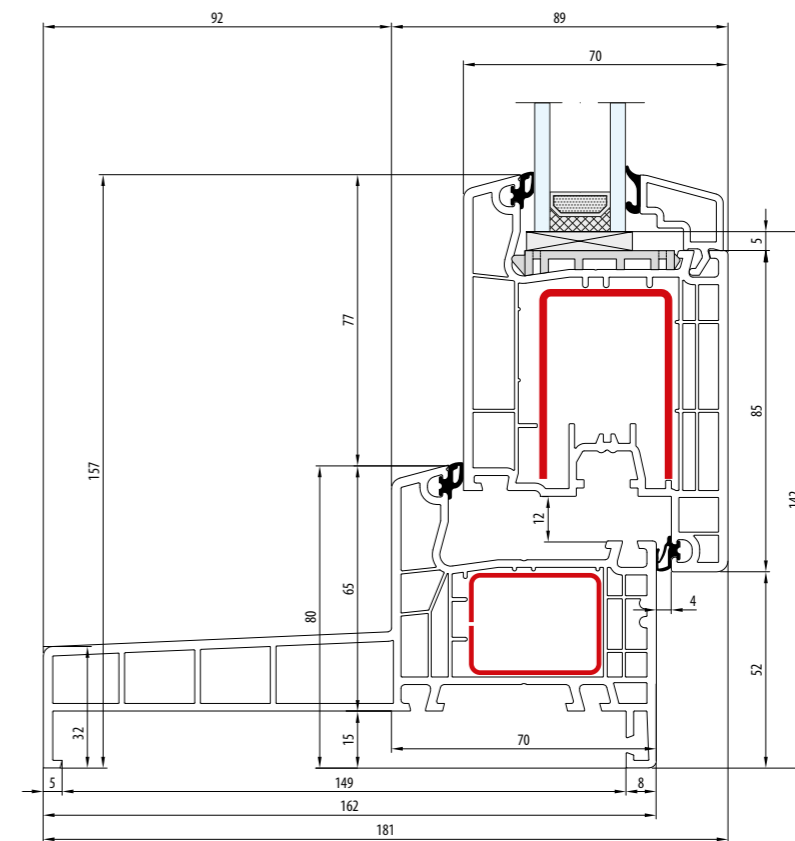
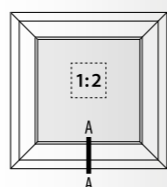

- MONOBLOCK - 160 mm · Rama: 80 mm · Skrzydło: 105 mm
- MONOBLOC - 160 mm · Dormant: 80 mm · Vantail: 105 mm
- MONOBLOK - 160 mm · Frame: 80 mm · Sash: 105 mm
- MONOBLOCK - 160 mm · Rahmen: 80 mm · Flügel: 105 mm
- MONOBLOCK - 160 mm · Telaio: 80 mm · Anta: 105 mm

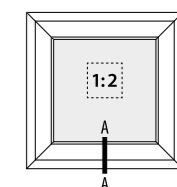

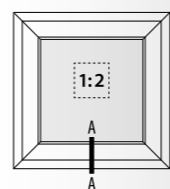
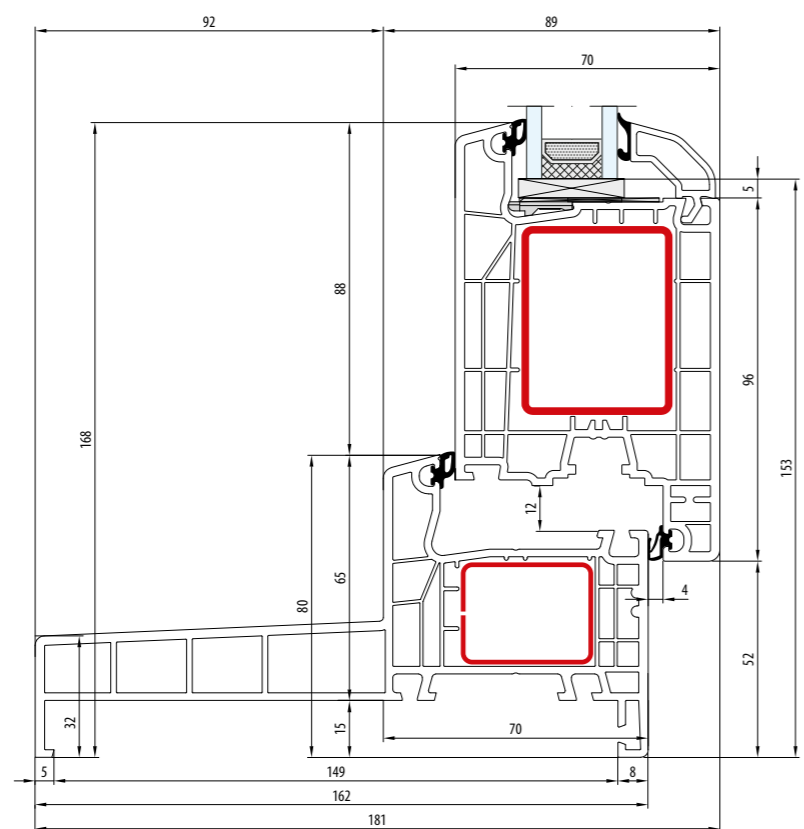

- MONOBLOCK - 160 mm · Rama: 80 mm · Skrzydło: 116 mm
- MONOBLOC - 160 mm · Dormant: 80 mm · Vantail: 116 mm
- MONOBLOK - 160 mm · Frame: 80 mm · Sash: 116 mm
- MONOBLOCK - 160 mm · Rahmen: 80 mm · Flügel: 116 mm
- MONOBLOCK - 160 mm · Telaio: 80 mm · Anta: 116 mm

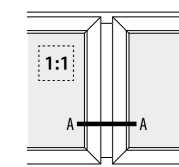
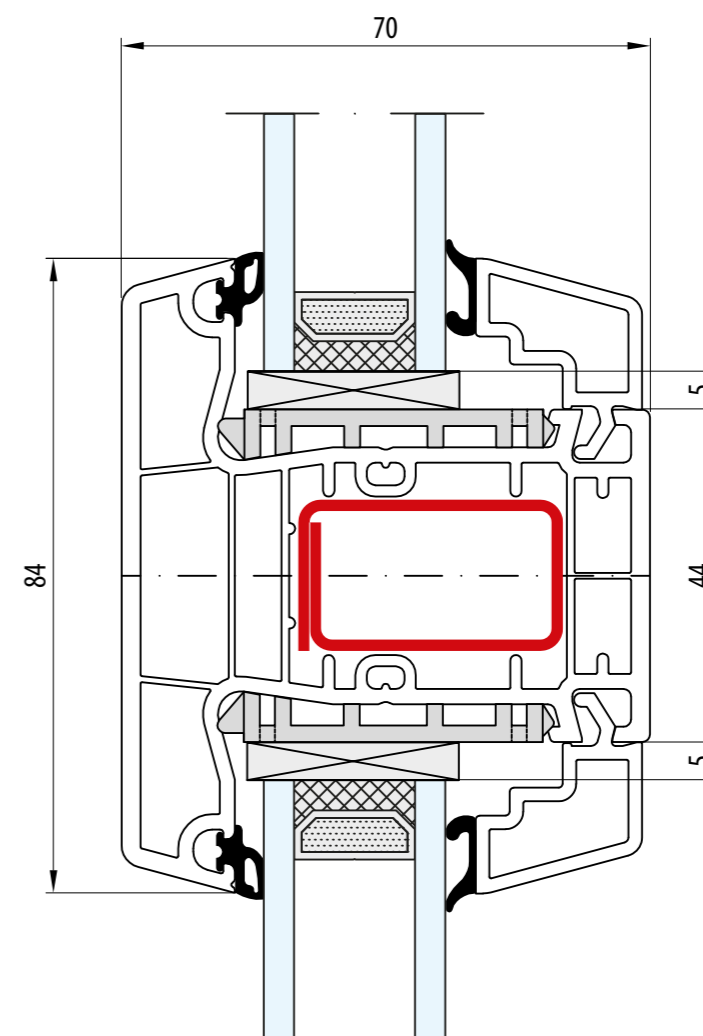

- Słupek staly: 84 mm
- Meneau fixe: 84 mm
- Fix post: 84 mm
- Festem Pfahl: 84 mm
- Montante fisso: 84 mm

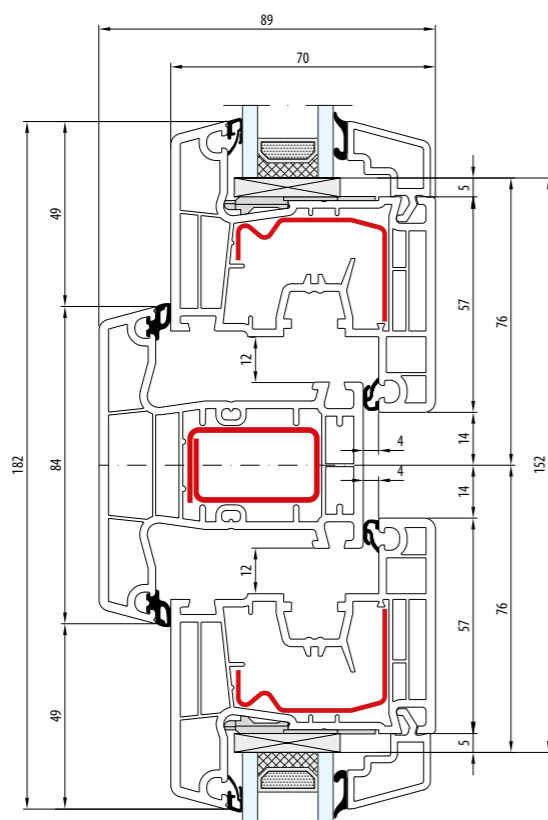

- Słupek stalowy: 84 mm · Skrzydło: 77 mm
- Meneau fixe: 84 mm · Vantail: 77 mm
- Fix post: 84 mm · Sash: 77 mm
- Festem Pfahl: 84 mm · Flügel: 77 mm
- Montante fisso: 84 mm · Anta: 77 mm

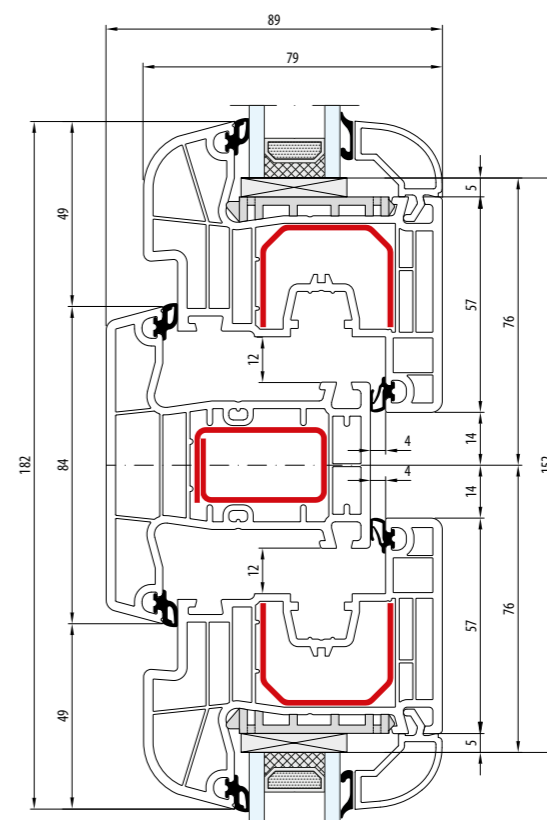
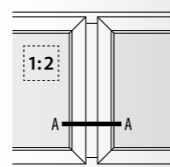

- Słupek stalowy: 84 mm · Skrzydło: 77 mm
- Meneau fixe: 84 mm · Vantail: 77 mm
- Fix post: 84 mm · Sash: 77 mm
- Festem Pfahl: 84 mm · Flügel: 77 mm
- Montante fisso: 84 mm · Anta: 77 mm

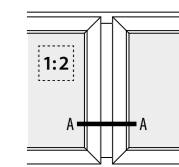

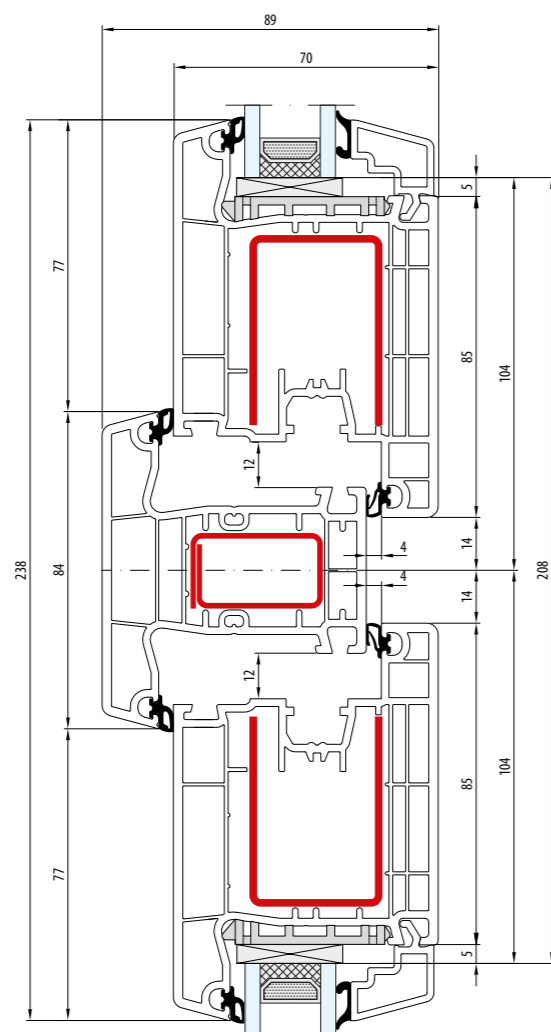

- Słupek stalowy: 84 mm · Skrzydło: 105 mm
- Meneau fixe: 84 mm · Vantail: 105 mm
- Fix post: 84 mm · Sash: 105 mm
- Festem Pfahl: 84 mm · Flügel: 105 mm
- Montante fisso: 84 mm · Anta: 105 mm

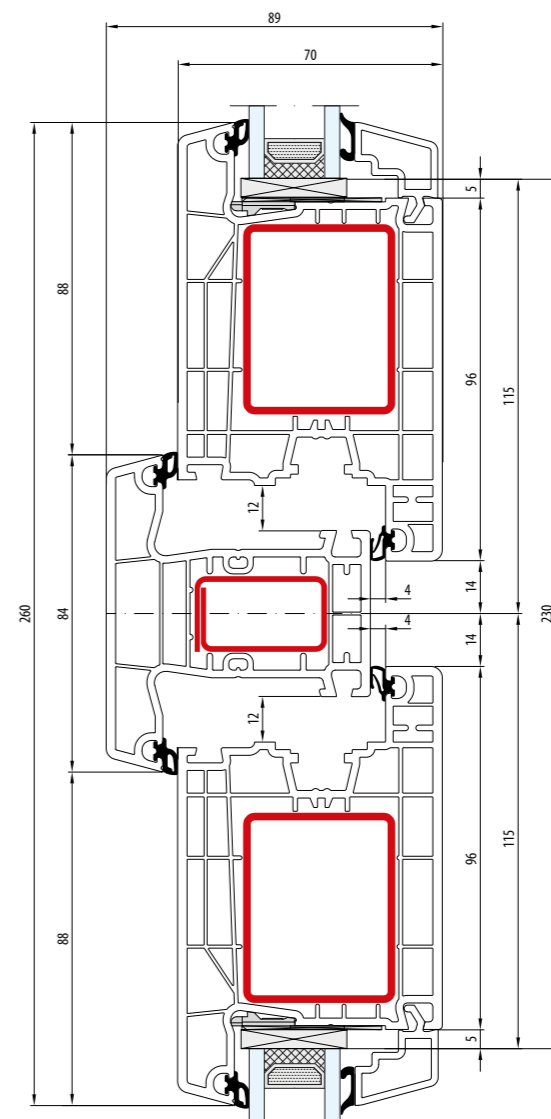
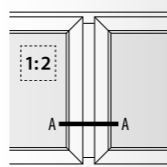

- Słupek stalowy: 84 mm · Skrzydło: 116 mm
- Meneau fixe: 84 mm · Vantail: 116 mm
- Fix post: 84 mm · Sash: 116 mm
- Festem Pfahl: 84 mm · Flügel: 116 mm
- Montante fisso: 84 mm · Anta: 116 mm

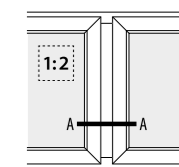

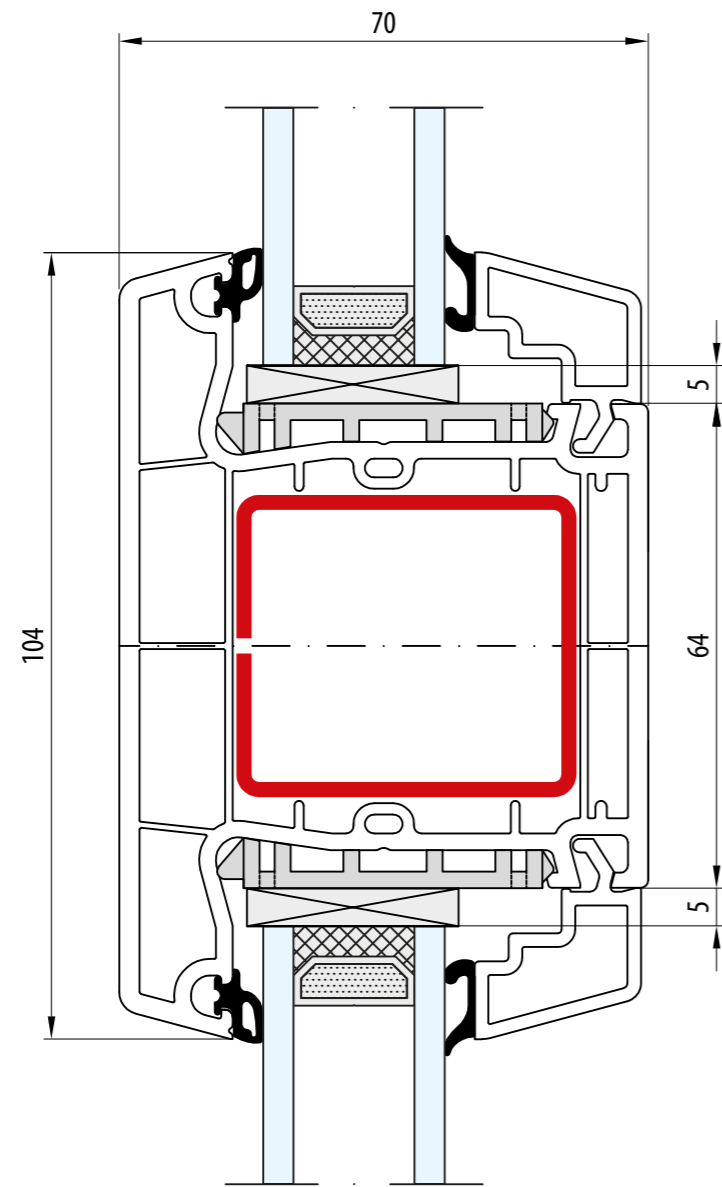

- Słupek stalowy: 104 mm
- Meneau fixe: 104 mm
- Fix post: 104 mm
- Festem Pfahl: 104 mm
- Montante fisso: 104 mm

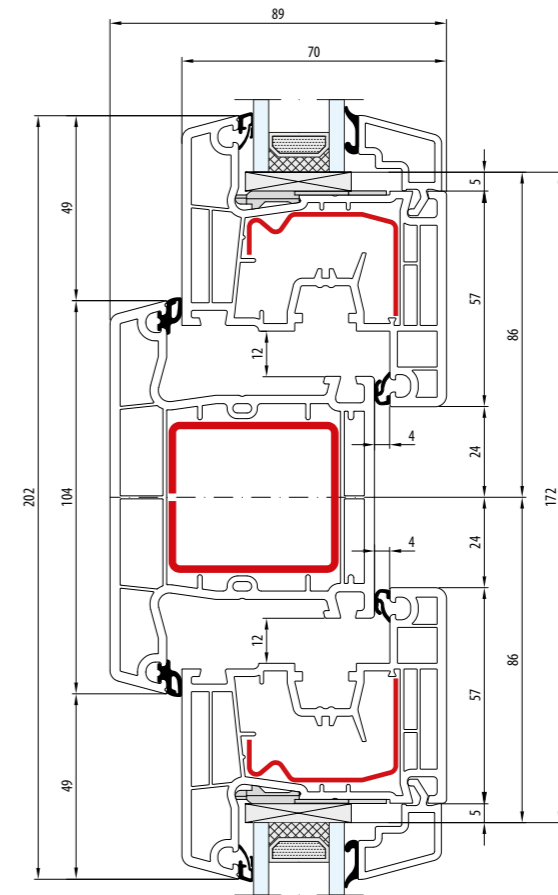
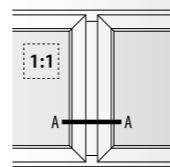

- Słupek stalowy: 104 mm · Skrzydło: 77 mm
- Meneau fixe: 104 mm · Vantail: 77 mm
- Fix post: 104 mm · Sash: 77 mm
- Festem Pfahl: 104 mm · Flügel: 77 mm
- Montante fisso: 104 mm · Anta: 77 mm

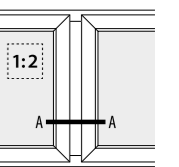

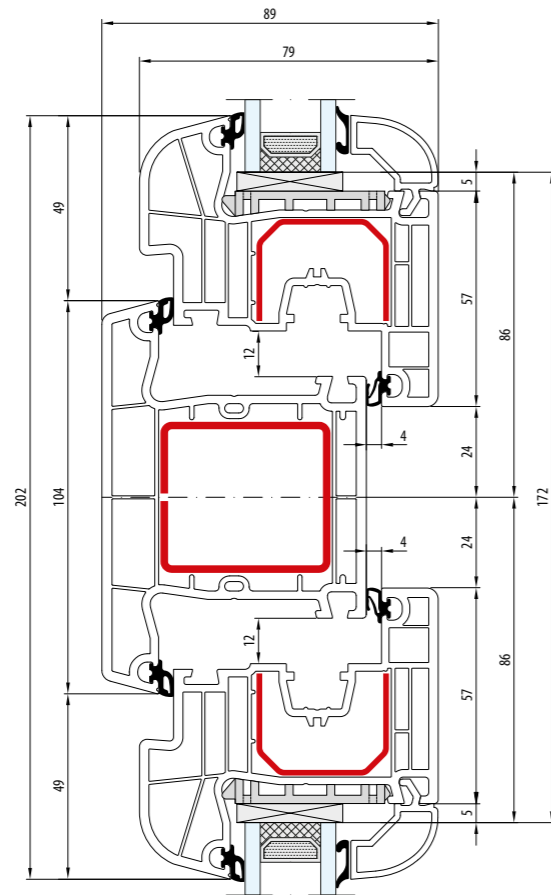

- Słupek stały: 104 mm · Skrzydło: 77 mm
- Meneau fixe: 104 mm · Vantail: 77 mm
- Fix post: 104 mm · Sash: 77 mm
- Festem Pfahl: 104 mm · Flügel: 77 mm
- Montante fisso: 104 mm · Anta: 77 mm

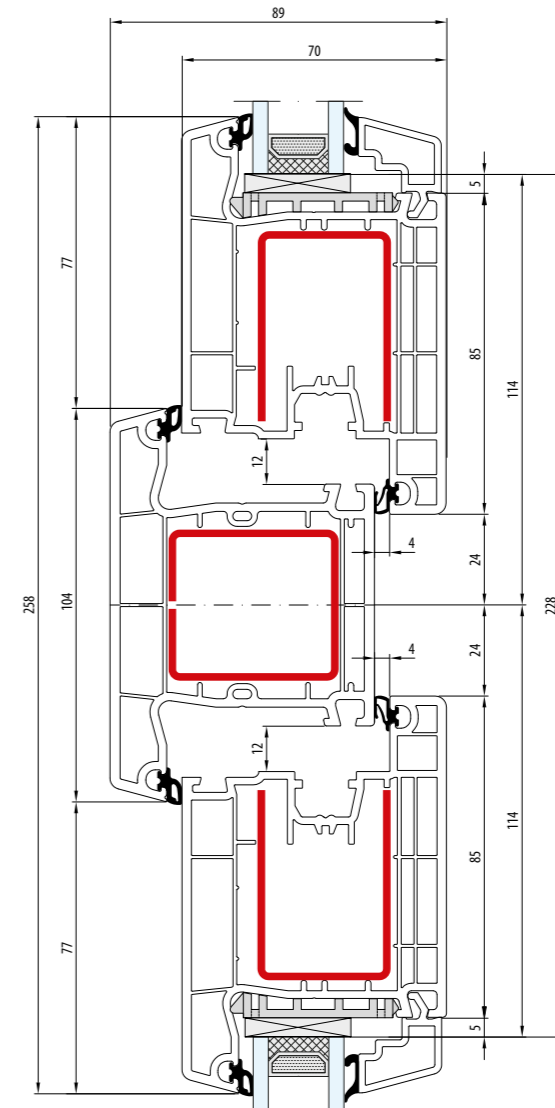
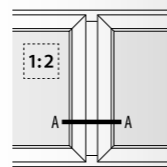

- Słupek stały: 104 mm · Skrzydło: 105 mm
- Meneau fixe: 104 mm · Vantail: 105 mm
- Fix post: 104 mm · Sash: 105 mm
- Festem Pfahl: 104 mm · Flügel: 105 mm
- Montante fisso: 104 mm · Anta: 105 mm

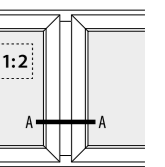

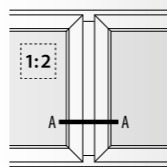
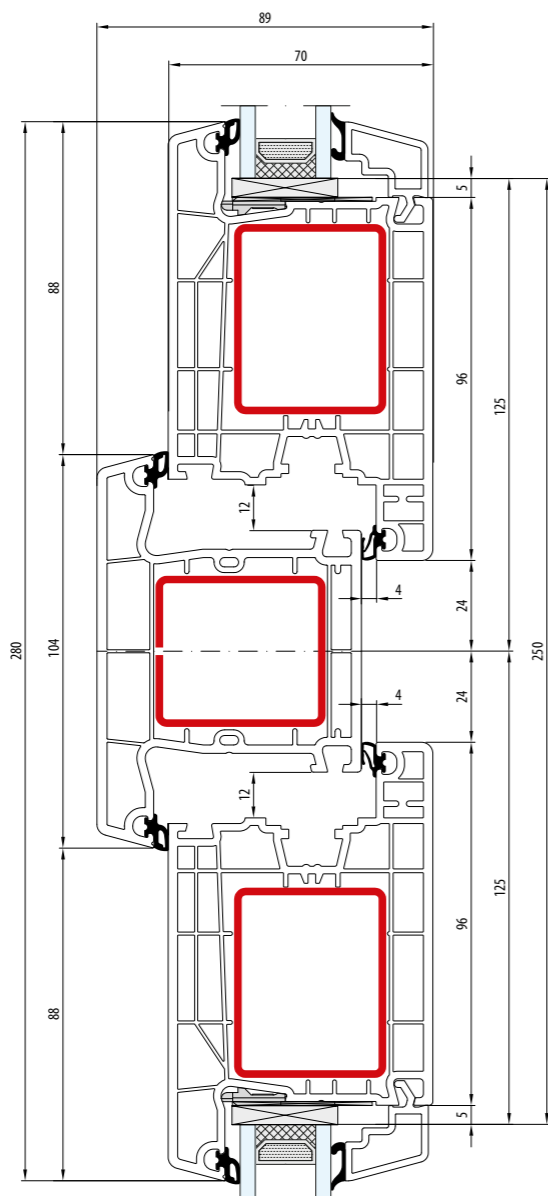

- Słupek stały: 104 mm · Skrzydło: 116 mm
- Meneau fixe: 104 mm · Vantail: 116 mm
- Fix post: 104 mm · Sash: 116 mm
- Festem Pfahl: 104 mm · Flügel: 116 mm
- Montante fisso: 104 mm · Anta: 116 mm

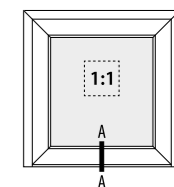
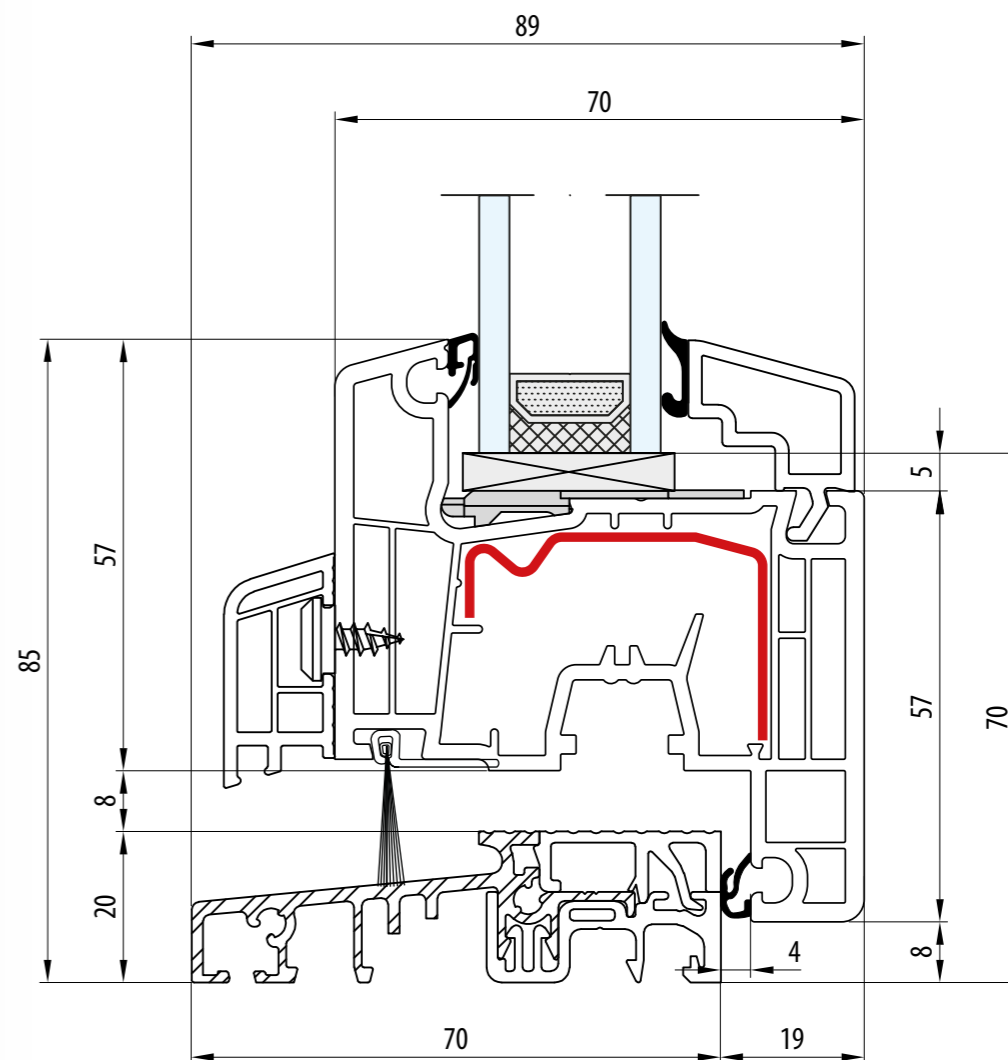

- Próg: 20 mm · Skrzydło: 77 mm
- Seuil: 20 mm · Vantail: 77 mm
- Threshold: 20 mm · Sash: 77 mm
- Schwelle: 20 mm · Flügel: 77 mm
- Soglia: 20 mm · Anta: 77 mm

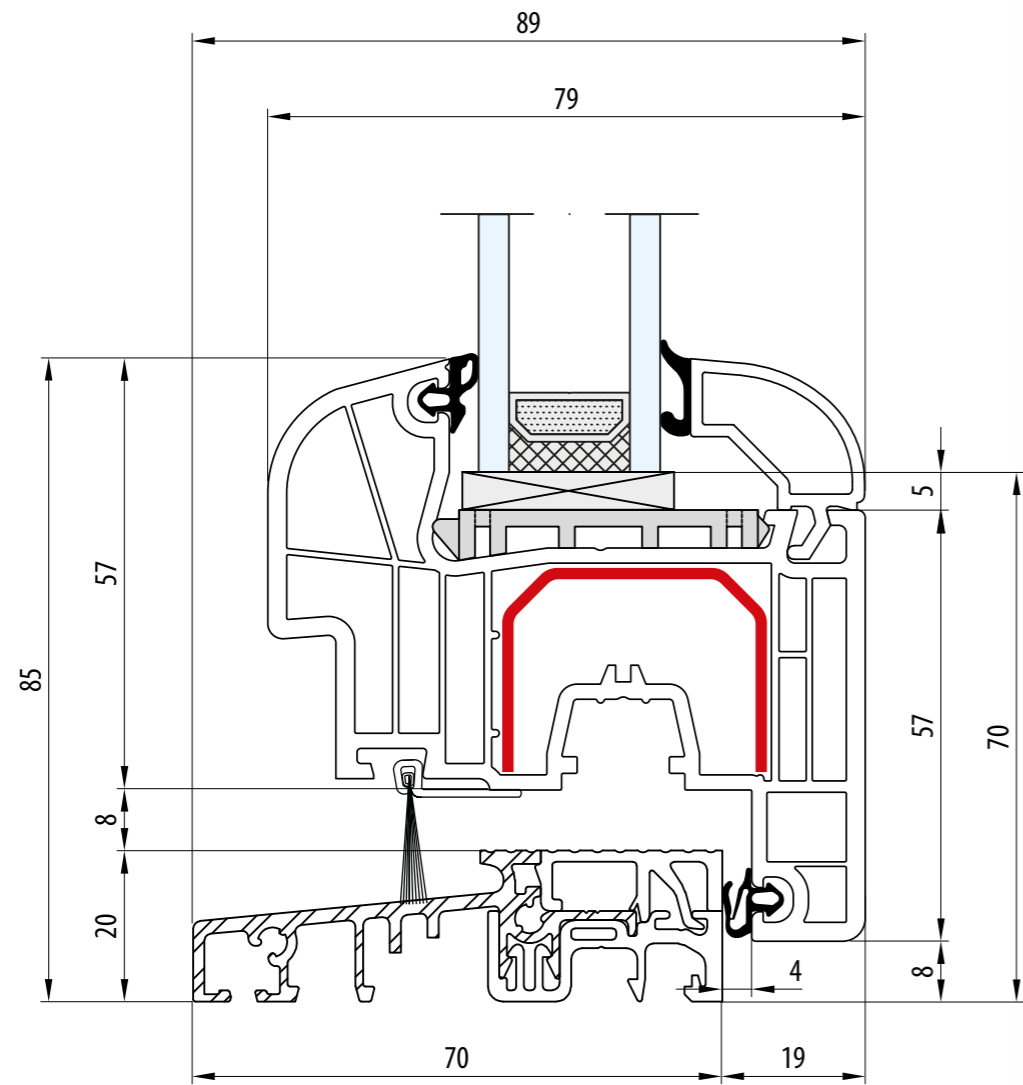

- Próg: 20 mm · Skrzydło: 77 mm
- Seuil: 20 mm · Vantail: 77 mm
- Threshold: 20 mm · Sash: 77 mm
- Schwelle: 20 mm · Flügel: 77 mm
- Soglia: 20 mm · Anta: 77 mm

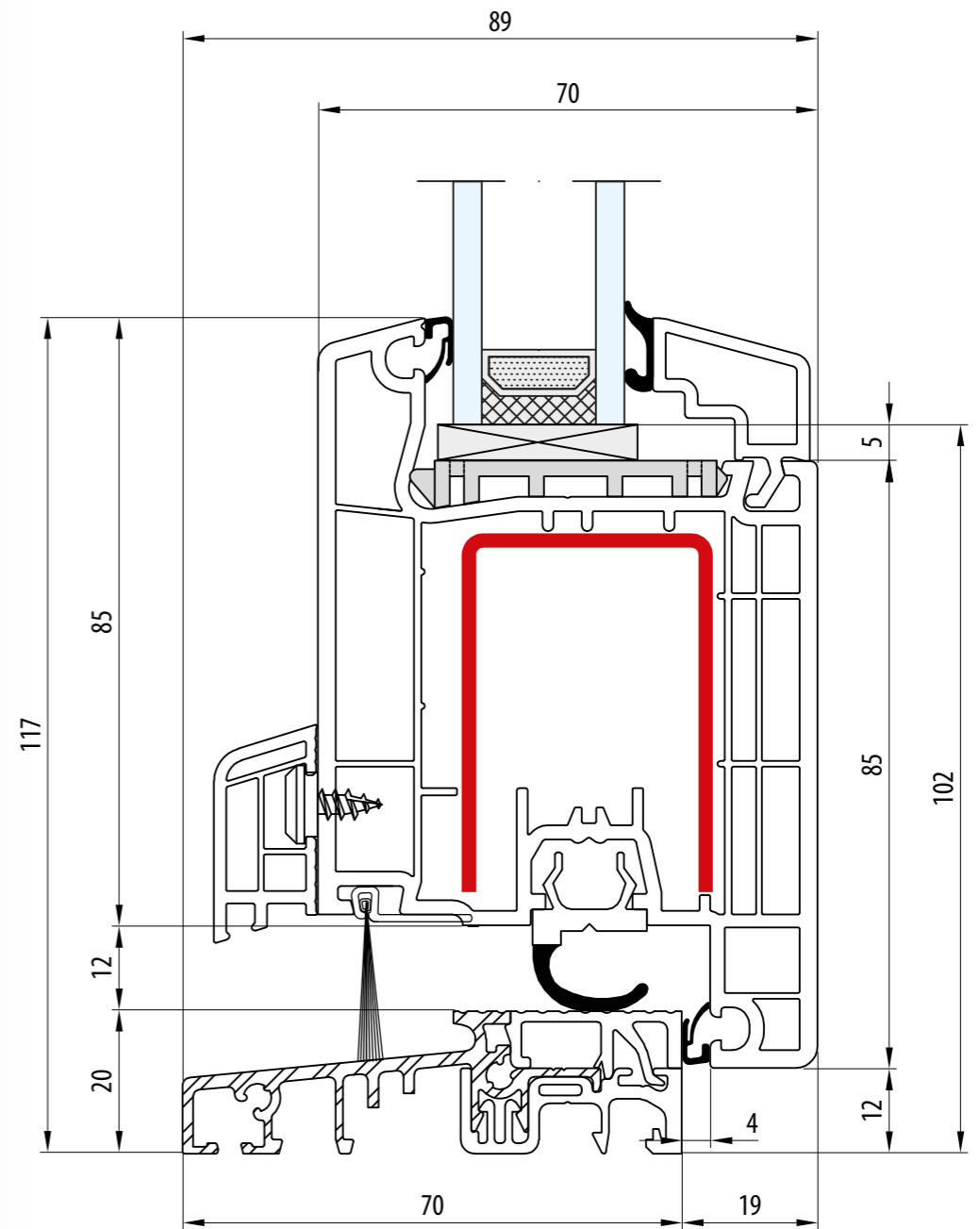
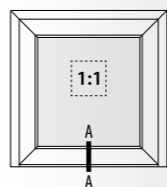

- Próg: 20 mm · Skrzydło: 105 mm
- Seuil: 20 mm · Vantail: 105 mm
- Threshold: 20 mm · Sash: 105 mm
- Schwelle: 20 mm · Flügel: 105 mm
- Soglia: 20 mm · Anta: 105 mm

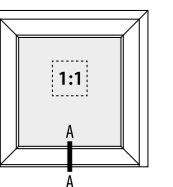

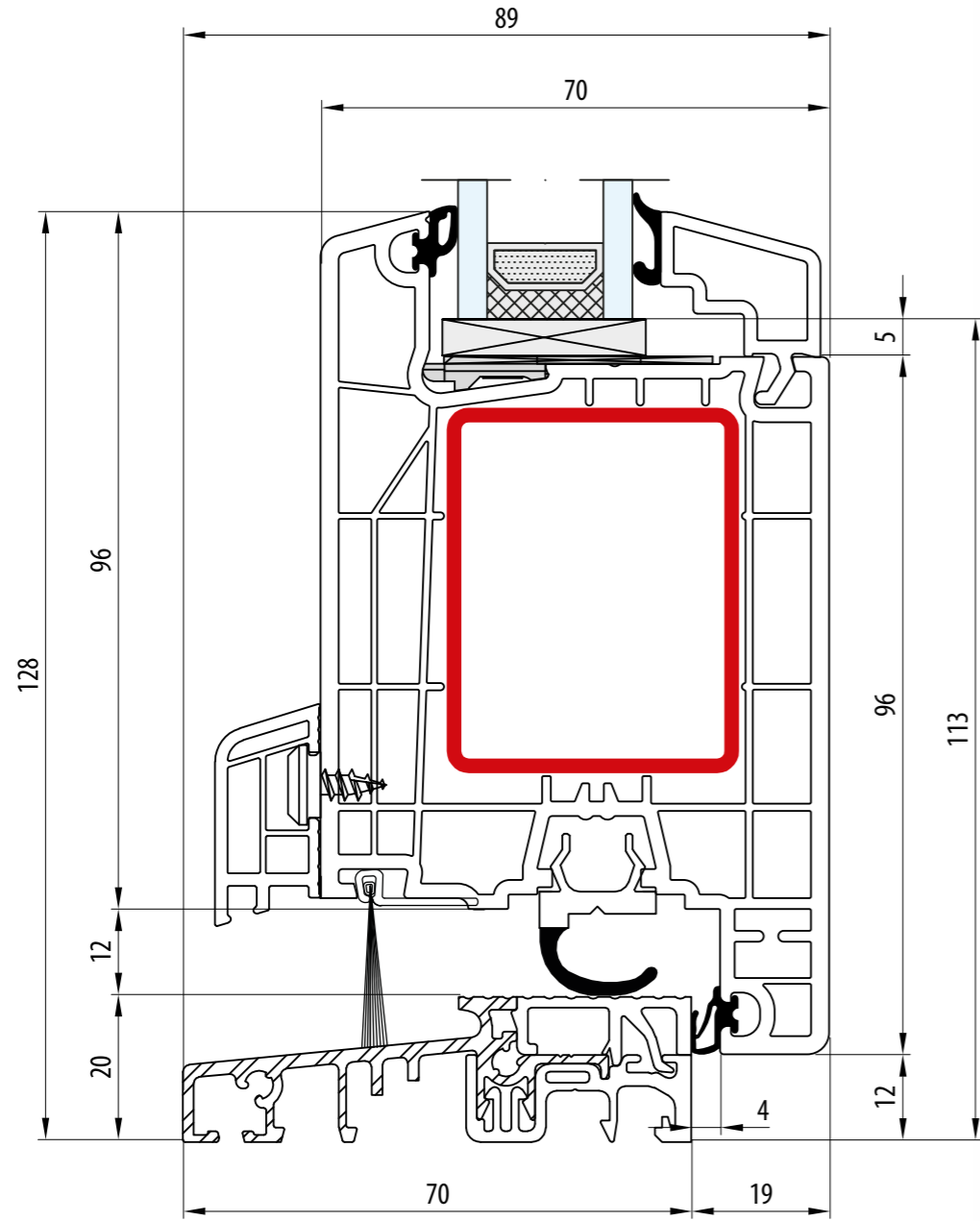

- Próg: 20 mm · Skrzydło: 116 mm
- Seuil: 20 mm · Vantail: 116 mm
- Threshold: 20 mm · Sash: 116 mm
- Schwelle: 20 mm · Flügel: 116 mm
- Soglia: 20 mm · Anta: 116 mm

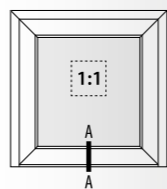

NORDLINE

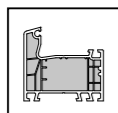

5



2

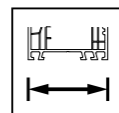

120

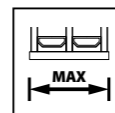

42

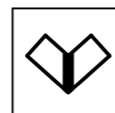

V SUPER SOLUTION



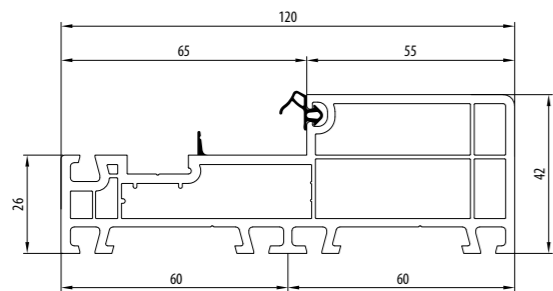

CL 140x90

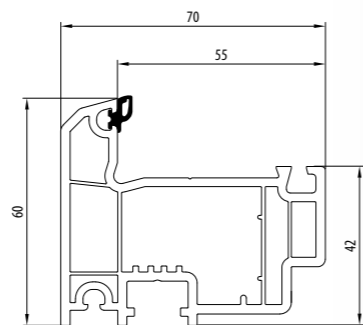

SL 140x93

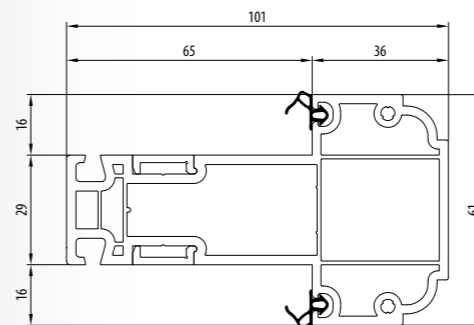

CL 140x98

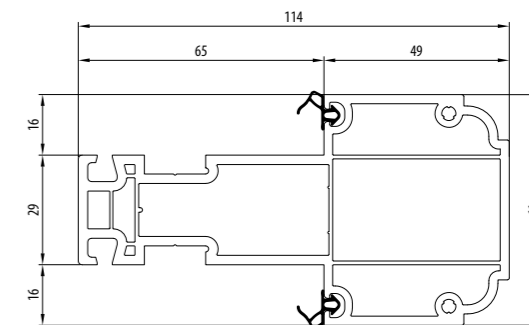

CL 140x99

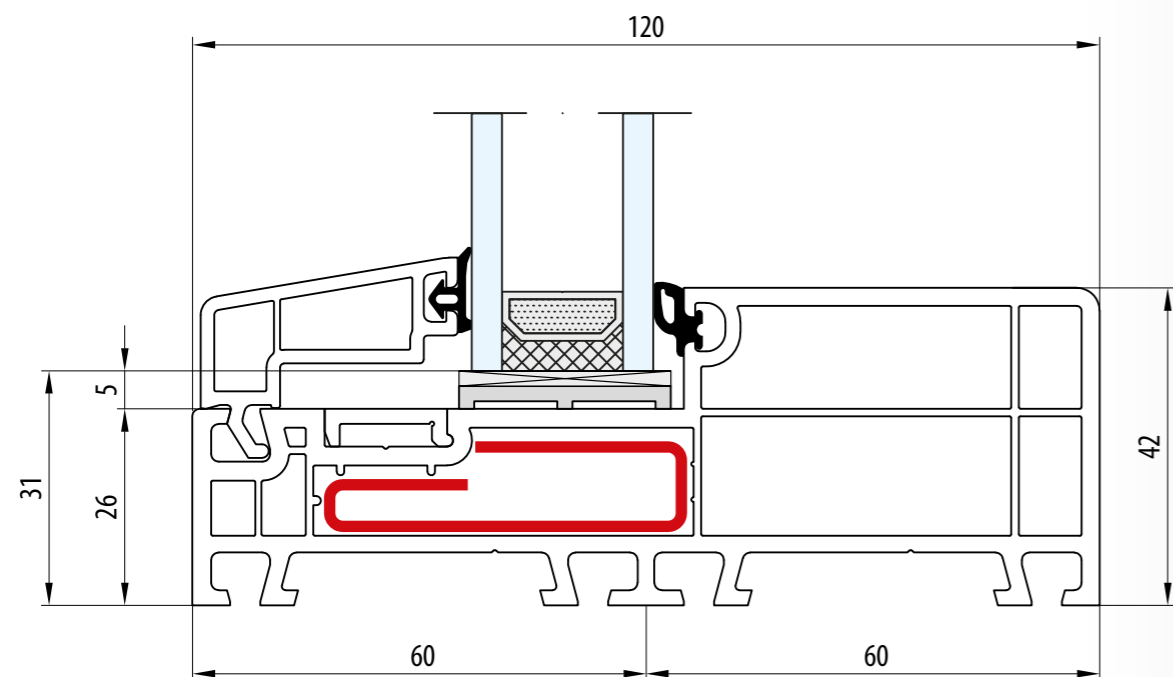

- Rama: 42 mm
- Dormant: 42 mm
- Frame: 42 mm
- Rahmen: 42 mm
- Telaio: 42 mm

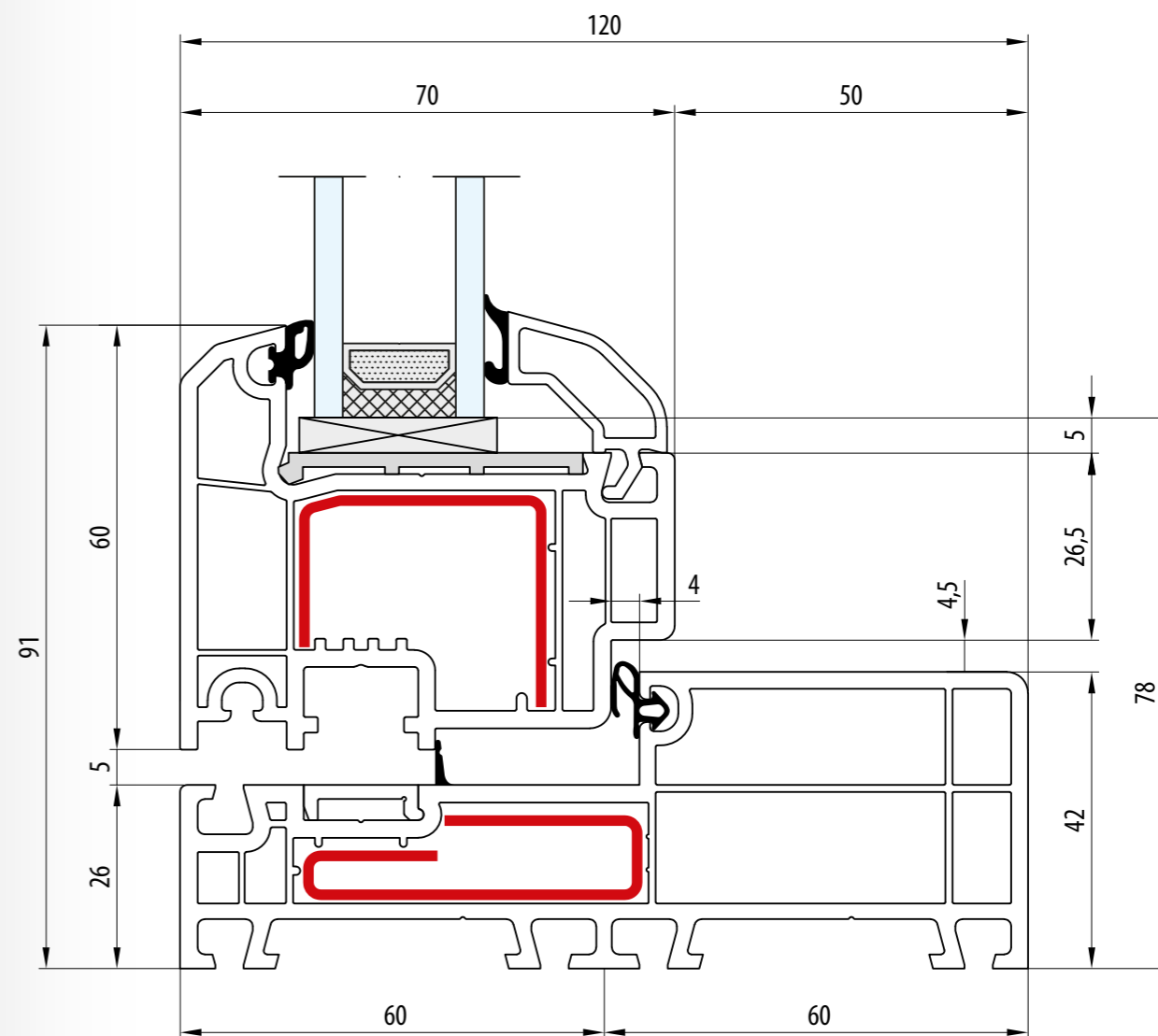
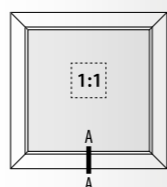

- Rama: 42 mm · Skrzydło: 60 mm
- Dormant: 42 mm · Vantail: 60 mm
- Frame: 42 mm · Sash: 60 mm
- Rahmen: 42 mm · Flügel: 60 mm
- Telaio: 42 mm · Anta: 60 mm

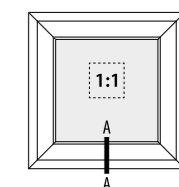

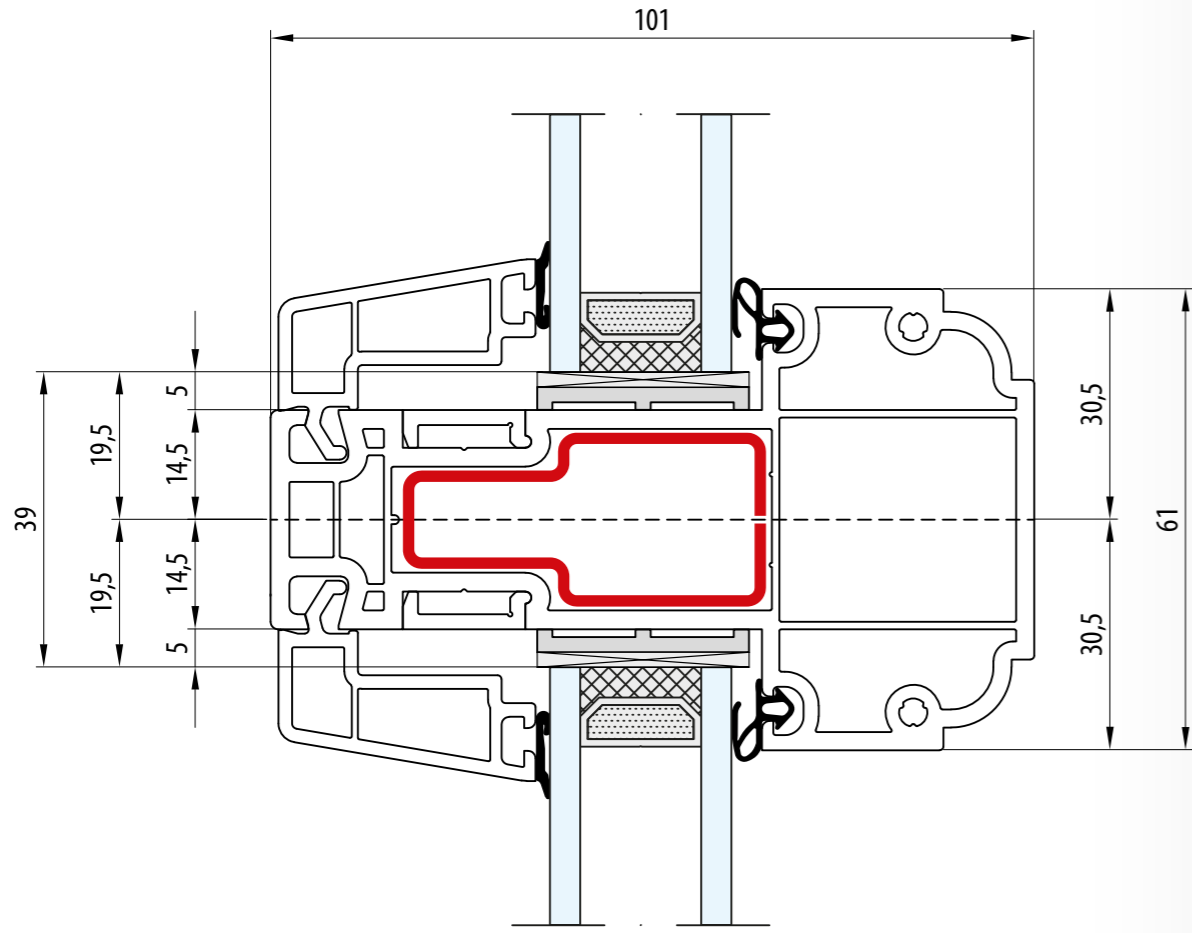

- Poprzeczka: 61 mm
- Traverse: 61 mm
- Muntin bar: 61 mm
- Kämpfer: 61 mm
- Traverso: 61 mm

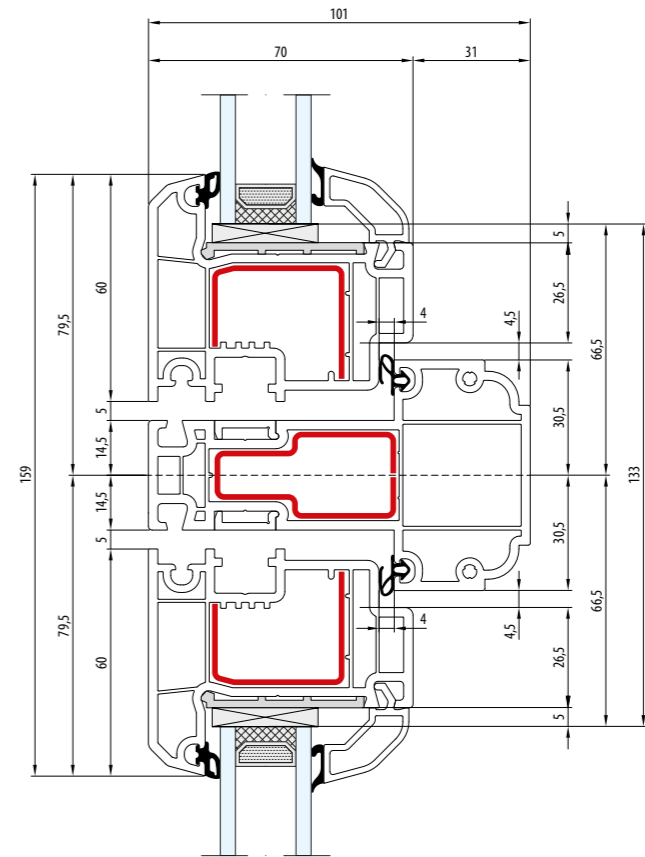
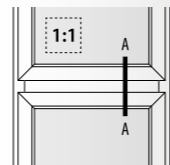

- Poprzeczka: 61 mm · Skrzydło: 60 mm
- Traverse: 61 mm · Vantail: 60 mm
- Muntin bar: 61 mm · Sash: 60 mm
- Kämpfer: 61 mm · Flügel: 60 mm
- Traverso: 61 mm · Anta: 60 mm

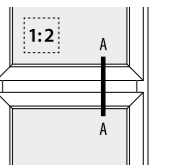

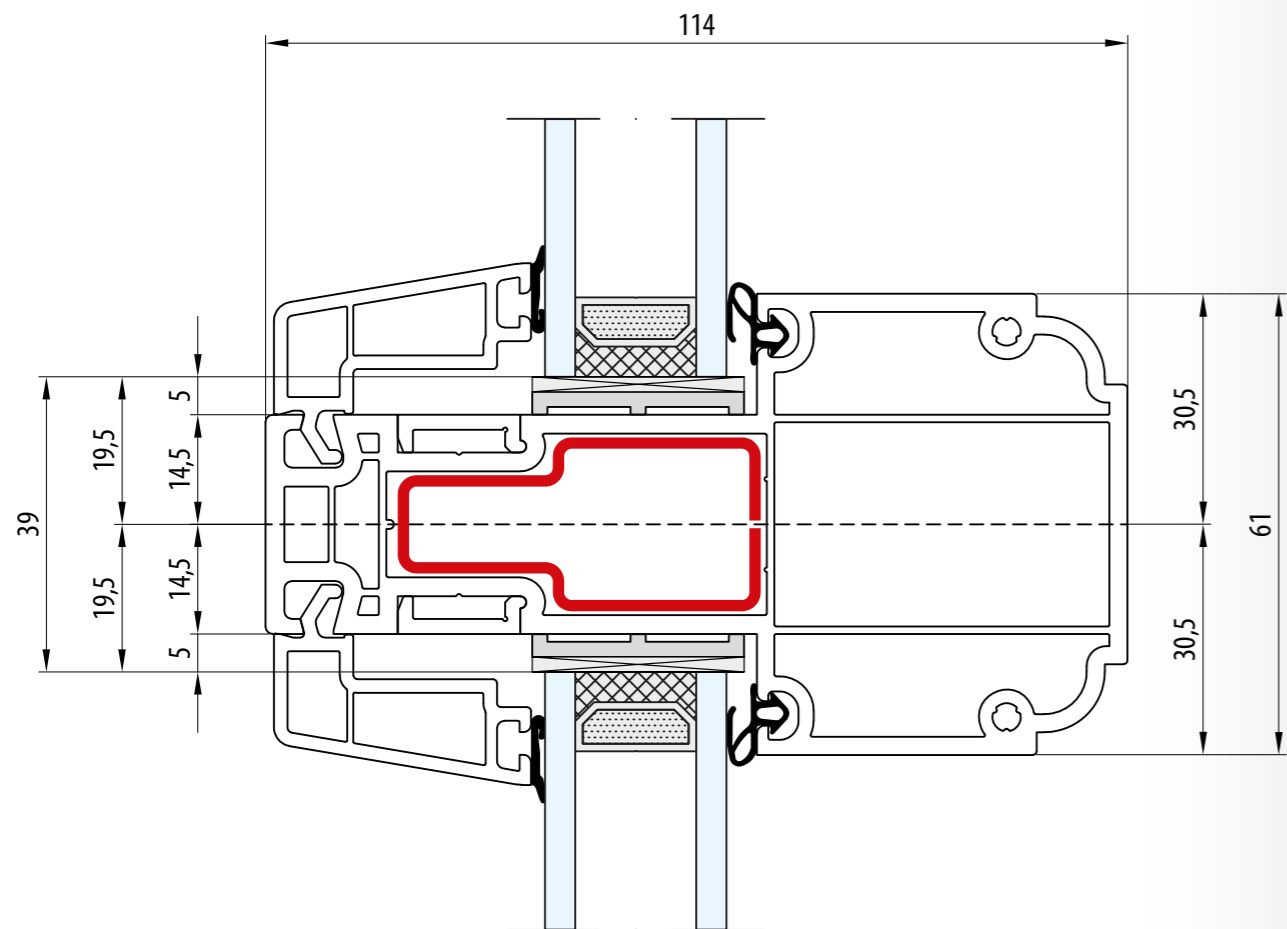

- Słupek stalowy: 61 mm
- Meneau fixe: 61 mm
- Fix post: 61 mm
- Festem Pfahl: 61 mm
- Montante fissa: 61 mm

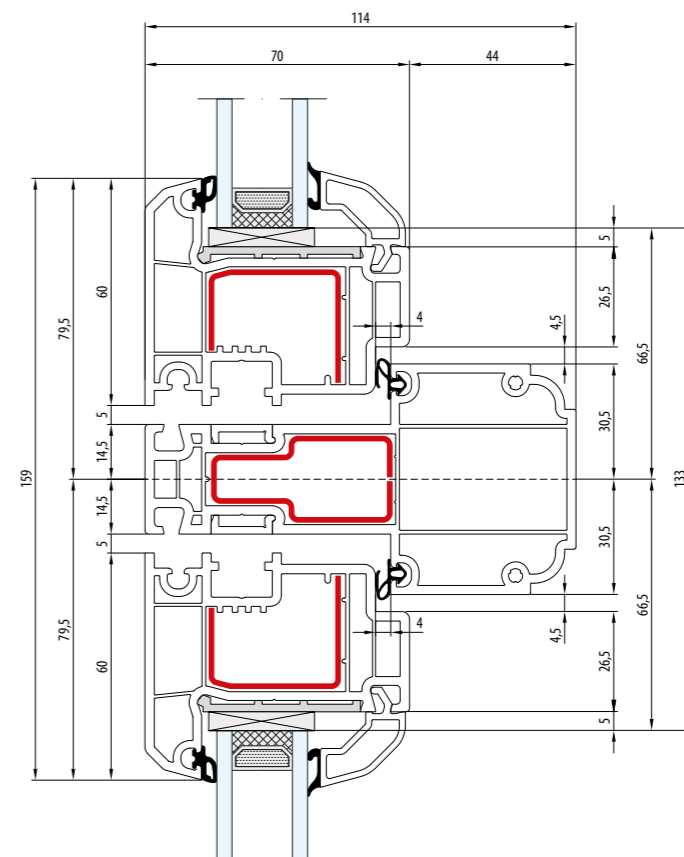
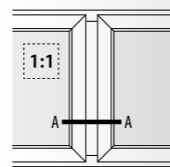

- Słupek stalowy: 61 mm · Skrzydło: 60 mm
- Meneau fixe: 61 mm · Vantail: 60 mm
- Fix post: 61 mm · Sash: 60 mm
- Festem Pfahl: 61 mm · Flügel: 60 mm
- Montante fissa: 61 mm · Anta: 60 mm

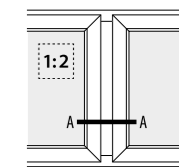

IDEAL 70 - CASEMENT

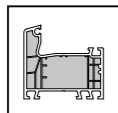
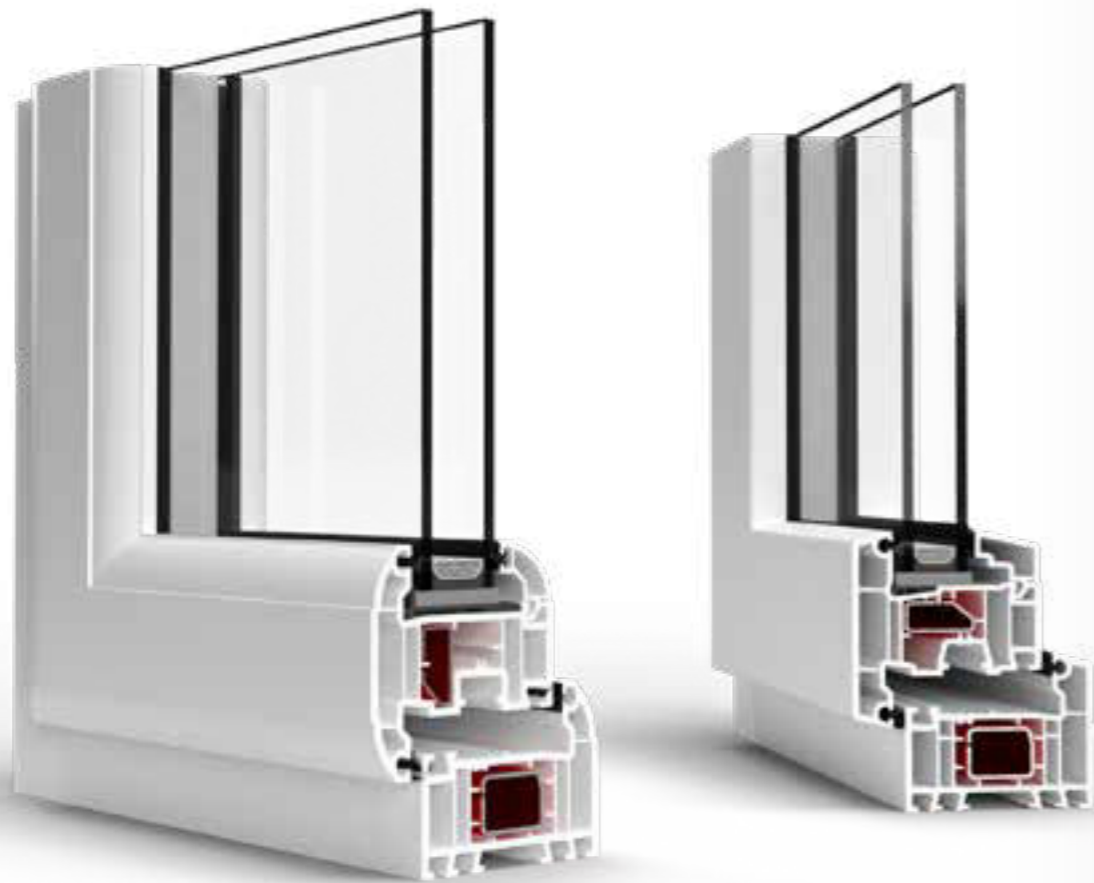

5



2

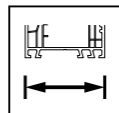

70

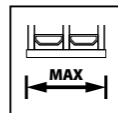

42

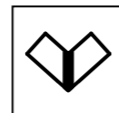

STD

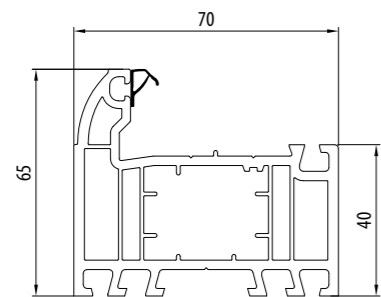

100x03

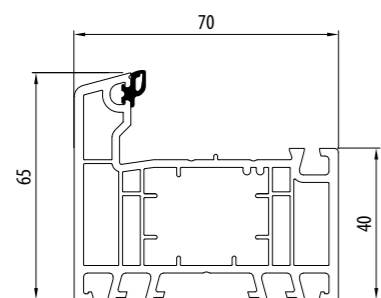

100x53

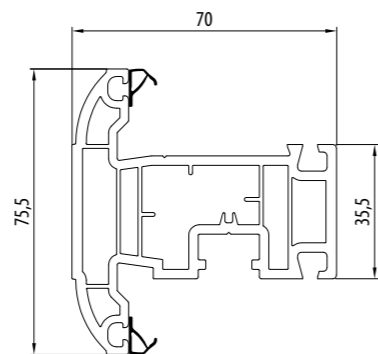

100x05

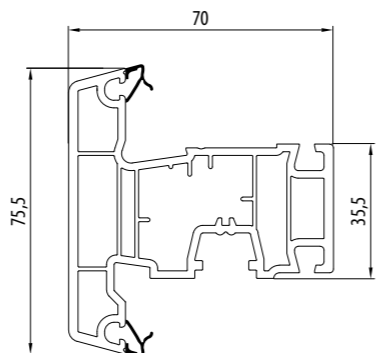

100x55

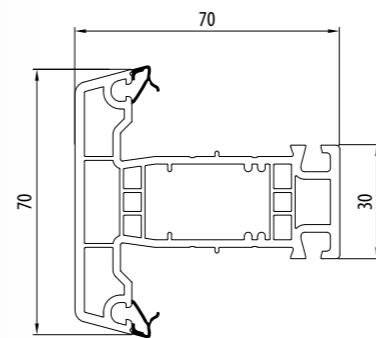

100x56

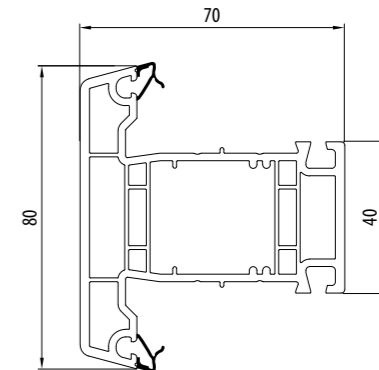

100x58

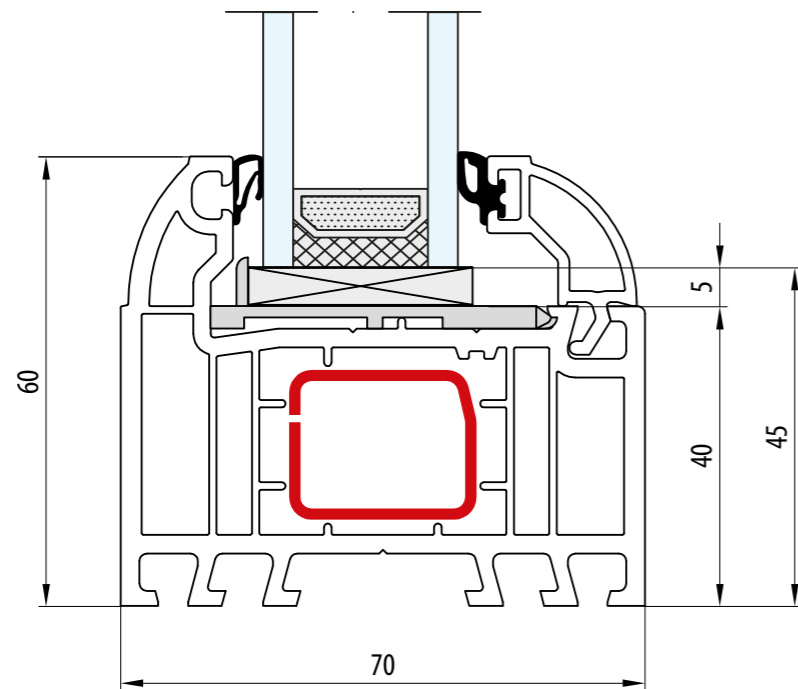

- Rama: 60 mm
- Dormant: 60 mm
- Frame: 60 mm
- Rahmen: 60 mm
- Telaio: 60 mm

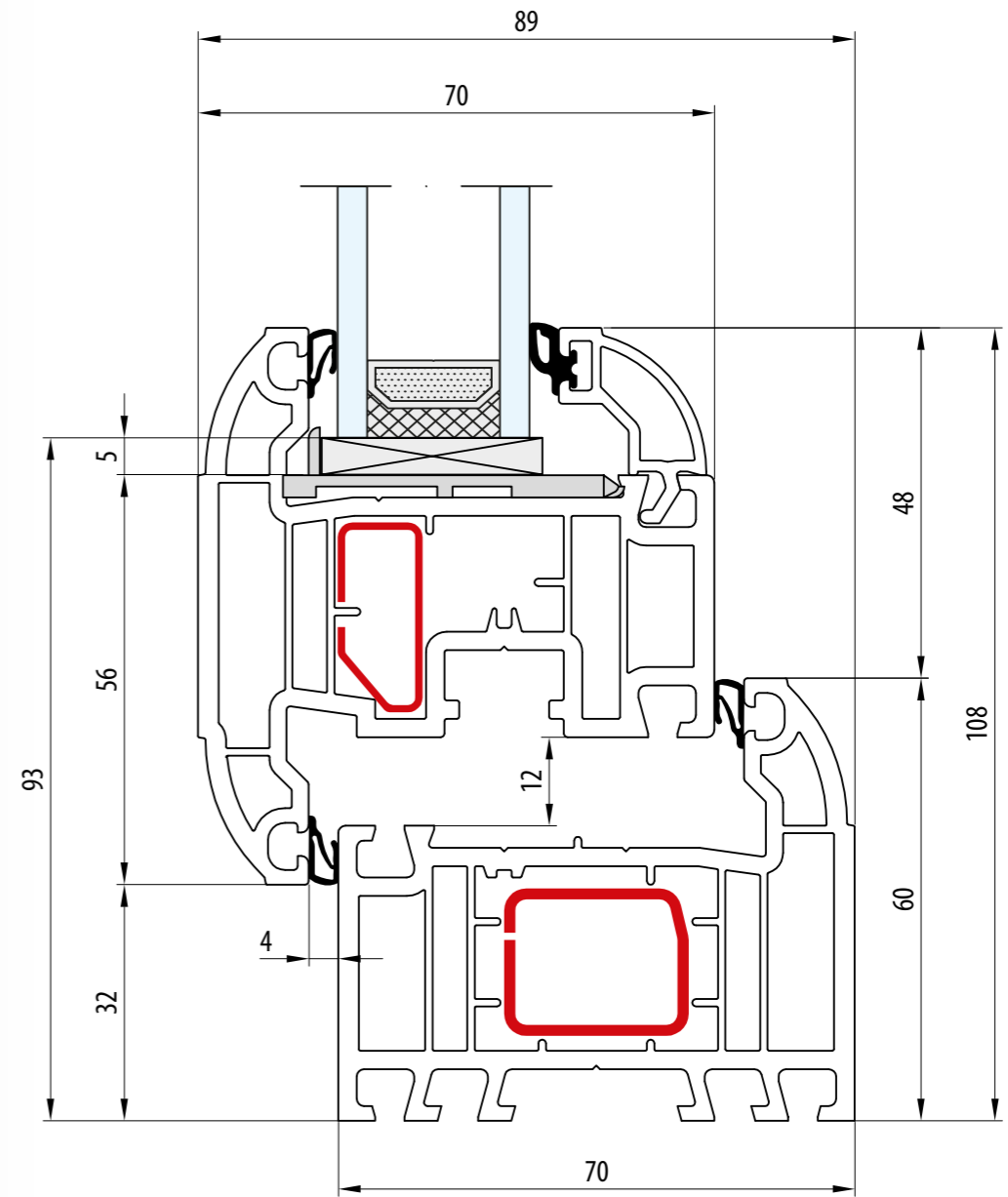
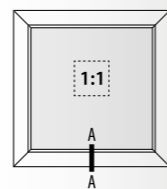

- Rama: 60 mm · Skrzydło: 76 mm
- Dormant: 60 mm · Vantail: 76 mm
- Frame: 60 mm · Sash: 76 mm
- Rahmen: 60 mm · Flügel: 76 mm
- Telaio: 60 mm · Anta: 76 mm

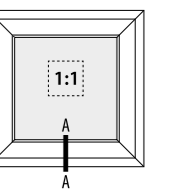

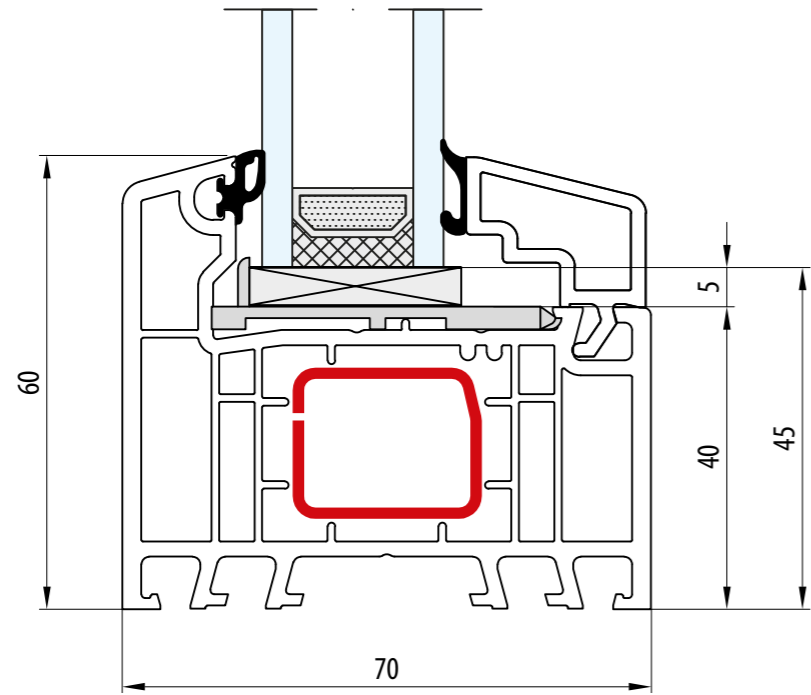



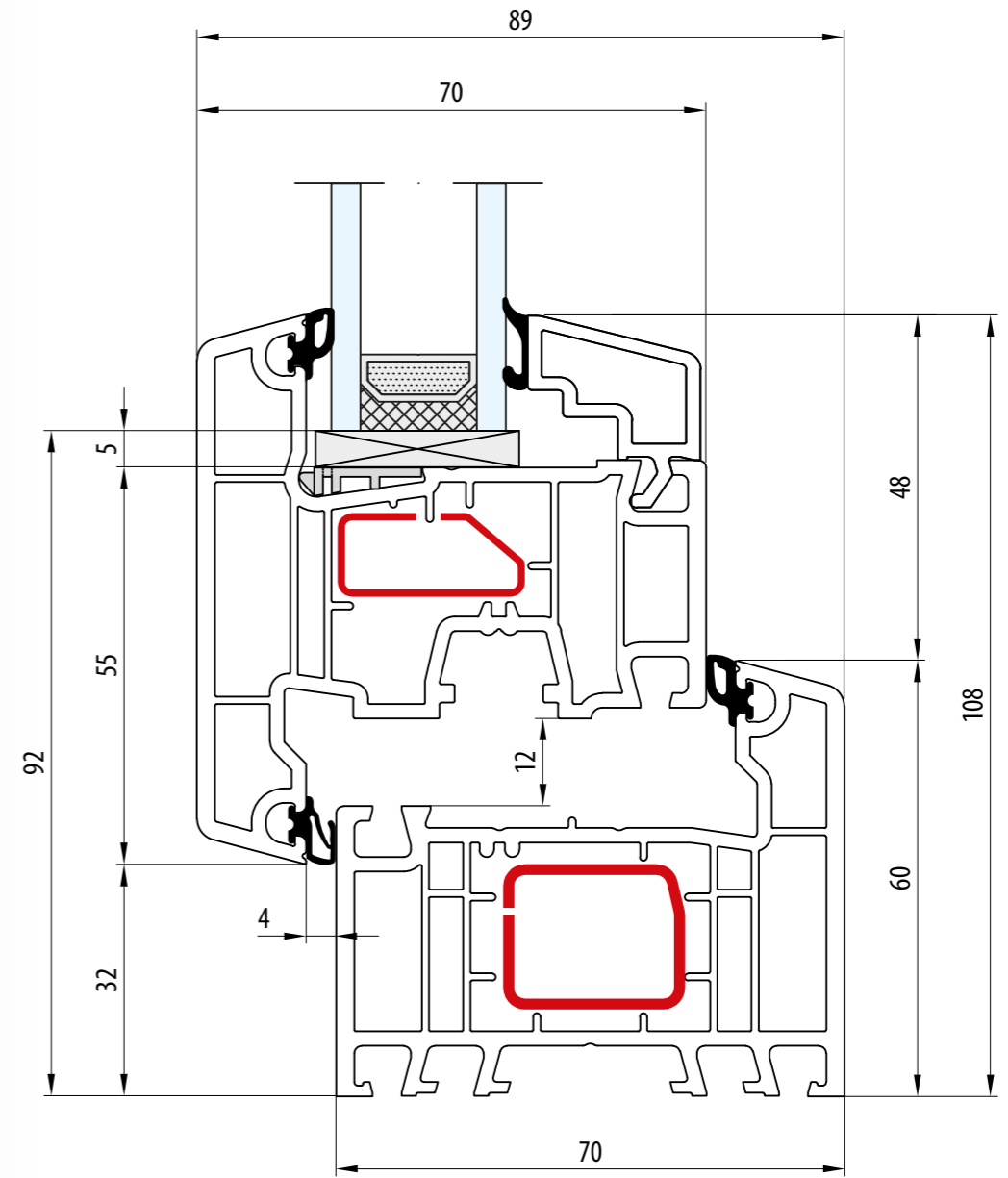
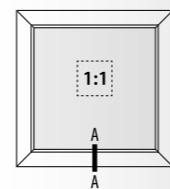

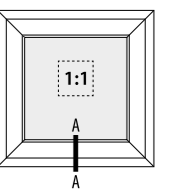

- Rama: 60 mm
- Dormant: 60 mm
- Frame: 60 mm
- Rahmen: 60 mm
- Telaio: 60 mm

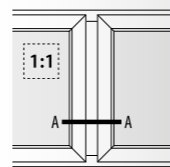
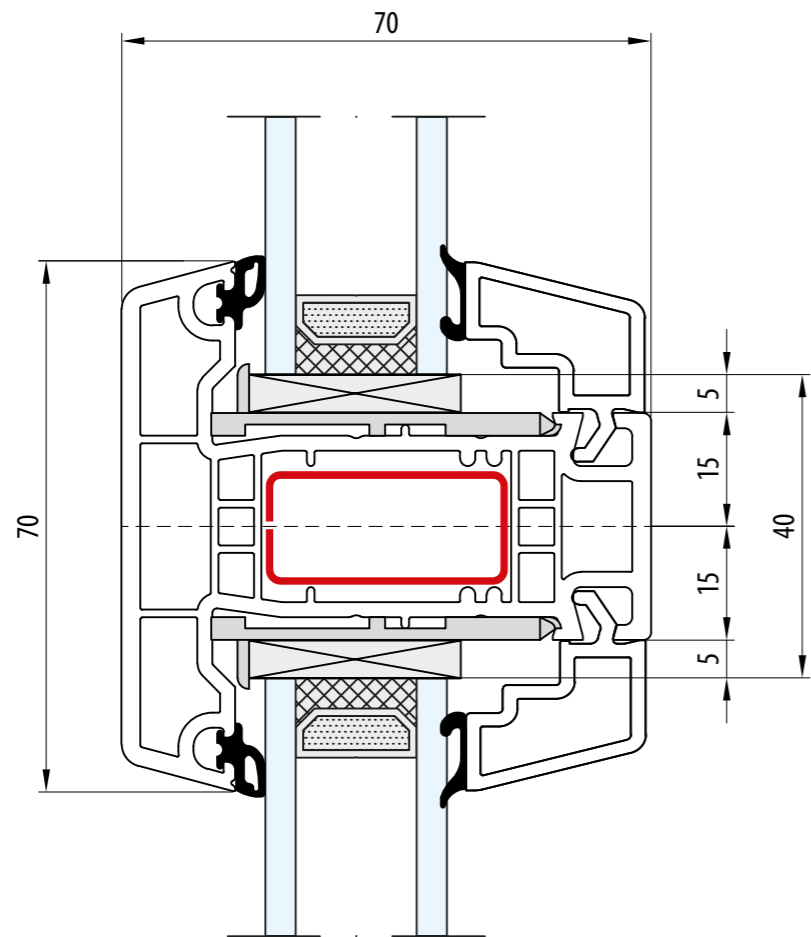







- Rama: 60 mm · Skrzydło: 75 mm
- Dormant: 60 mm · Vantail: 75 mm
- Frame: 60 mm · Sash: 75 mm
- Rahmen: 60 mm · Flügel: 75 mm
- Telaio: 60 mm · Anta: 75 mm

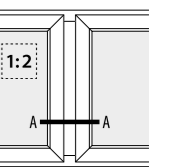
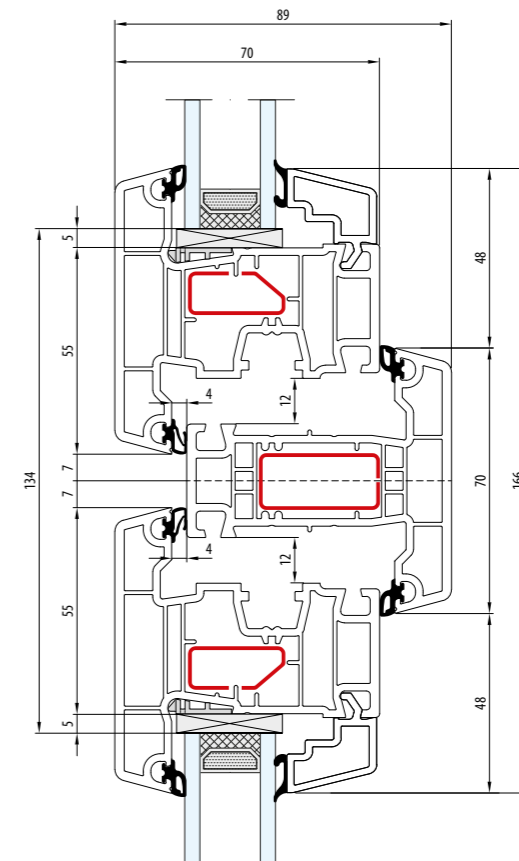







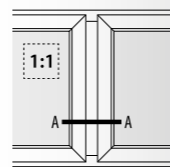
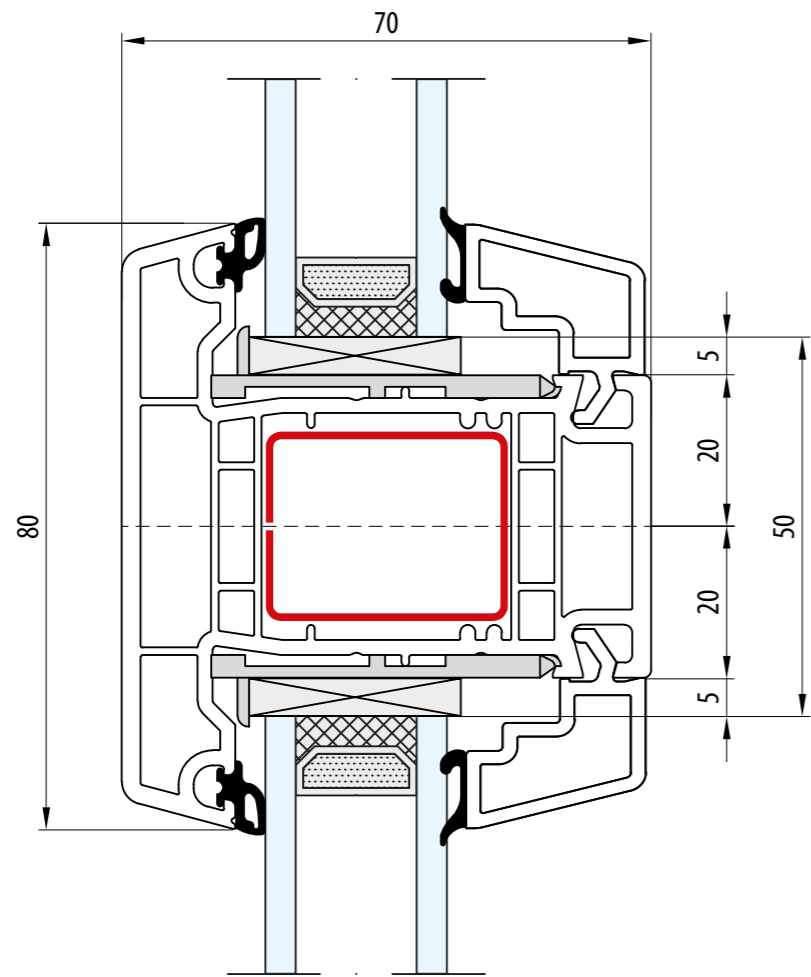

-  Słupek stalowy: 70 mm
-  Meneau fixe: 70 mm
-  Fix post: 70 mm
-  Festem Pfahl: 70 mm
-  Montante fissa: 70 mm







-  Słupek stalowy: 70 mm · Skrzydło: 75 mm
-  Meneau fixe: 70 mm · Vantail: 75 mm
-  Fix post: 70 mm · Sash: 75 mm
-  Festem Pfahl: 70 mm · Flügel: 75 mm
-  Montante fissa: 70 mm · Anta: 75 mm

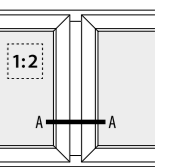
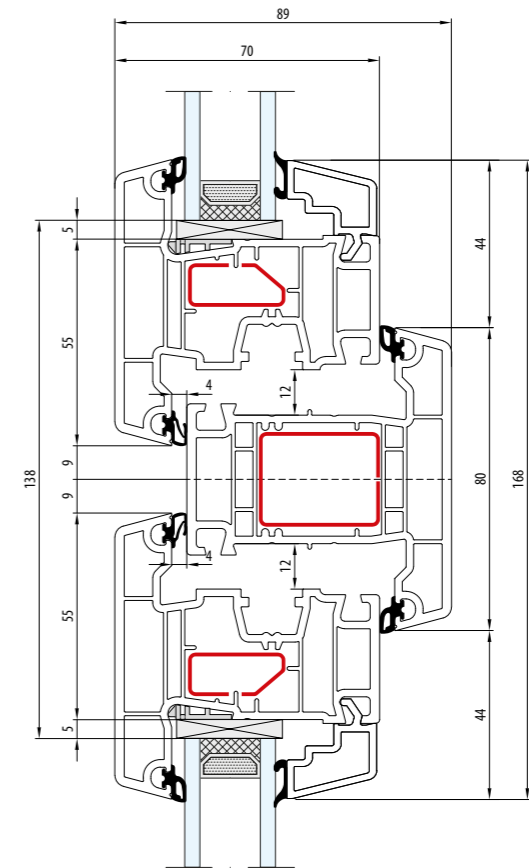

-  Słupek stalowy: 80 mm
-  Meneau fixe: 80 mm
-  Fix post: 80 mm
-  Festem Pfahl: 80 mm
-  Montante fissa: 80 mm



-  Słupek stalowy: 80 mm · Skrzydło: 75 mm
-  Meneau fixe: 80 mm · Vantail: 75 mm
-  Fix post: 80 mm · Sash: 75 mm
-  Festem Pfahl: 80 mm · Flügel: 75 mm
-  Montante fissa: 80 mm · Anta: 75 mm

EASY SLIDE

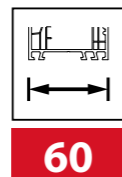
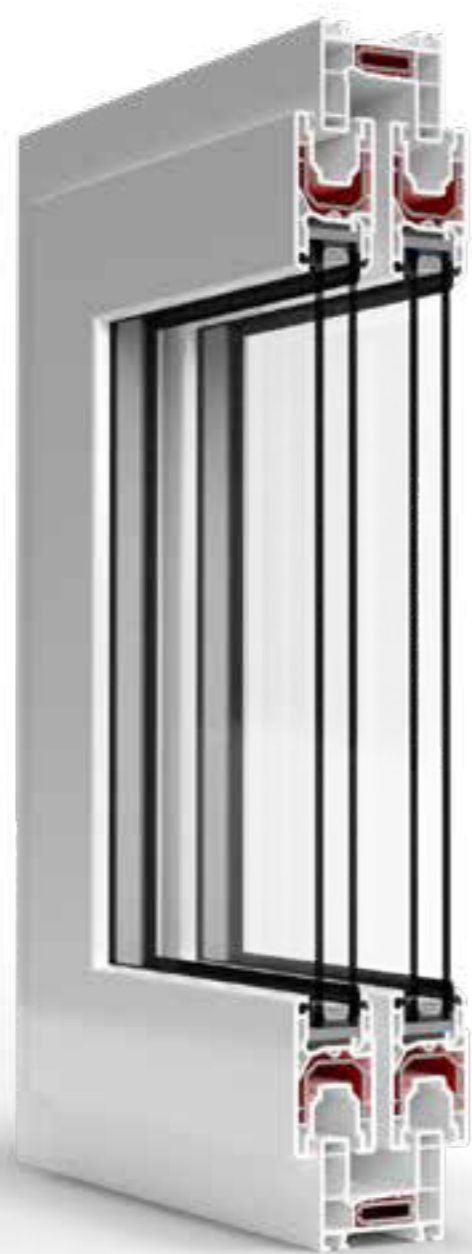

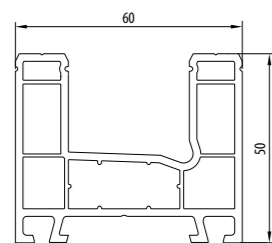



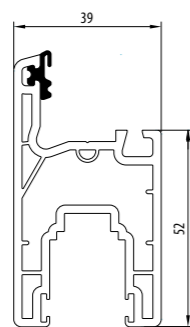

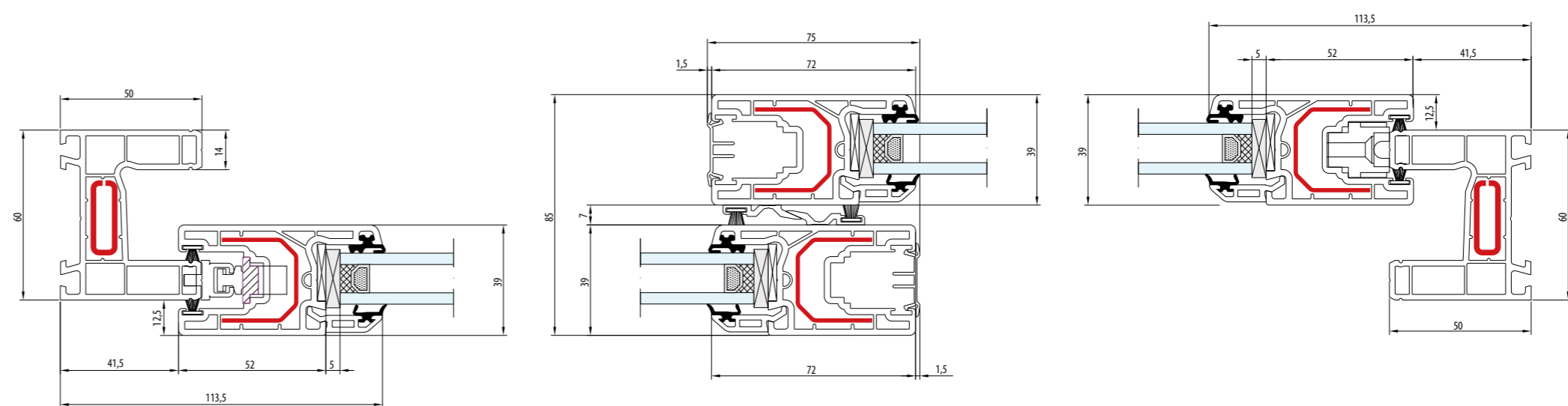

100069



100072



-  Schemat A - Przekrój poziomy · Rama: 50 mm · Skrzydło: 72 mm
-  Schéma A - Coupe horizontale · Dormant: 50 mm · Vantail: 72 mm
-  Schema A - Doorsnede horizontaal · Frame: 50 mm · Sash: 72 mm
-  Schema A - Wagerechter Schnitt · Rahmen: 50 mm · Flügel: 72 mm
-  Schema A - Sezione orizzontale · Telaio: 50 mm · Anta: 72 mm

1:2

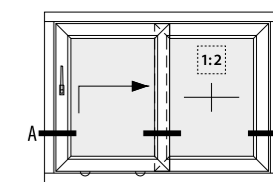

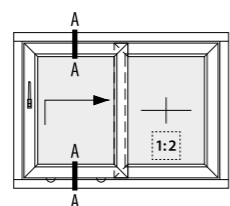
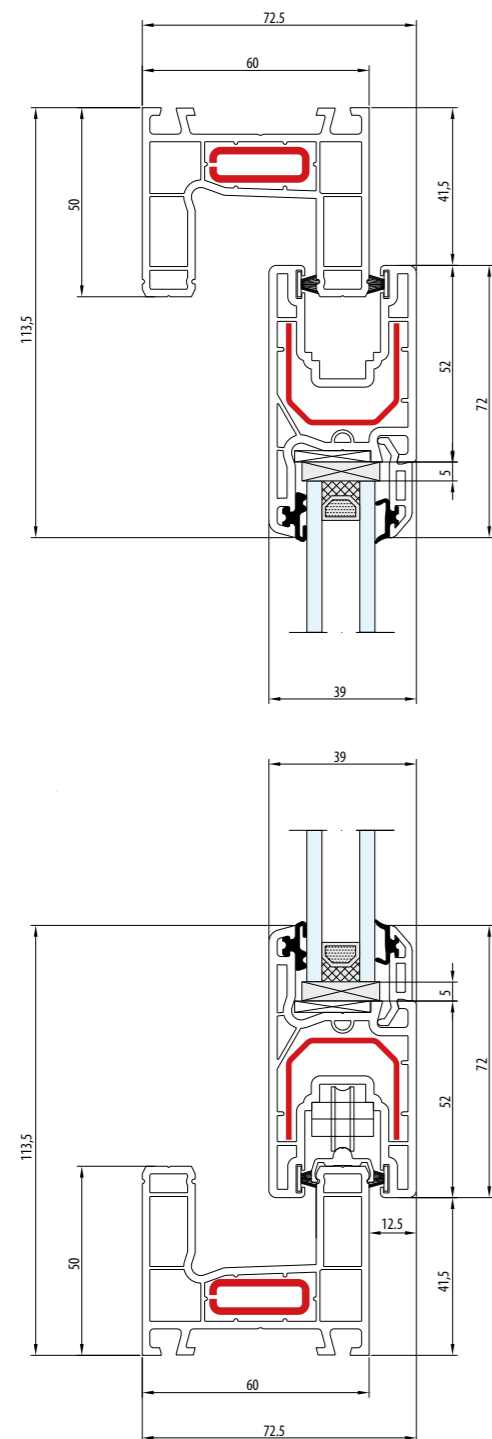

- Schemat A - Przekrój pionowy · Rama: 50 mm · Skrzydło: 72 mm
- Schéma A - Coupe verticale · Dormant: 50 mm · Vantail: 72 mm
- Schema A - Doorsnede verticaal · Frame: 50 mm · Sash: 72 mm
- Schema A - Senkrechter Schnitt · Rahmen: 50 mm · Flügel: 72 mm
- Schema A - Sezione verticale · Telaio: 50 mm · Anta: 72 mm

EASY SLIDE

MULTI SLIDE

SMART SLIDE

HST 70

HST 85

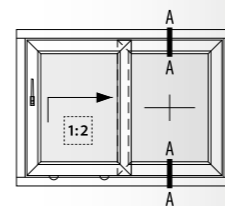
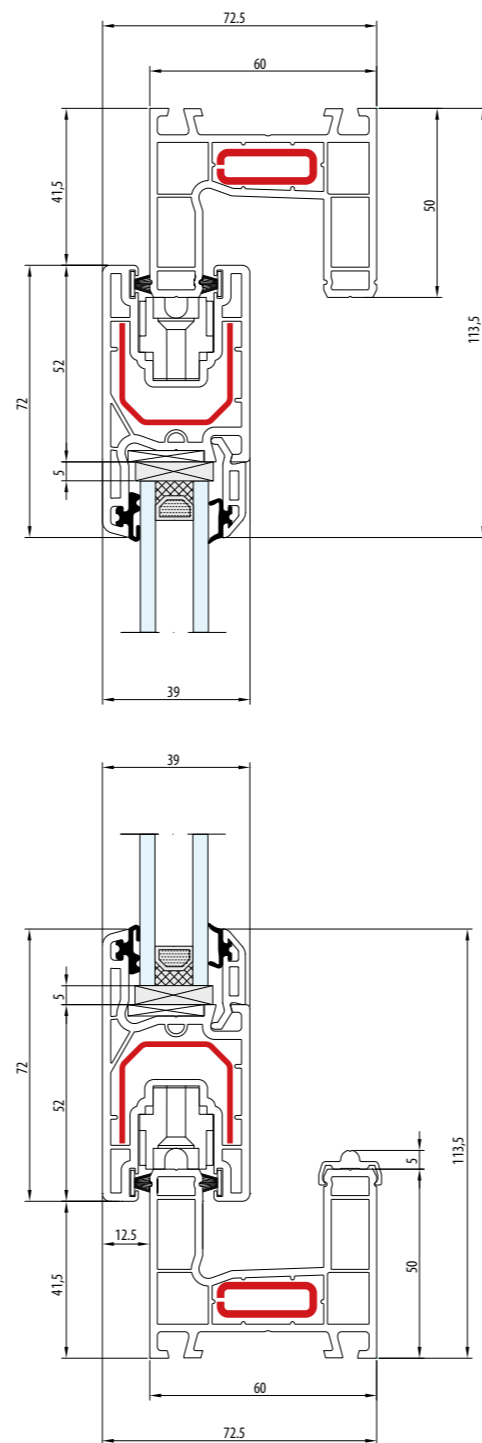

- Schemat A - Przekrój pionowy · Rama: 50 mm · Skrzydło: 72 mm
- Schéma A - Coupe verticale · Dormant: 50 mm · Vantail: 72 mm
- Schema A - Doorsnede verticaal · Frame: 50 mm · Sash: 72 mm
- Schema A - Senkrechter Schnitt · Rahmen: 50 mm · Flügel: 72 mm
- Schema A - Sezione verticale · Telaio: 50 mm · Anta: 72 mm

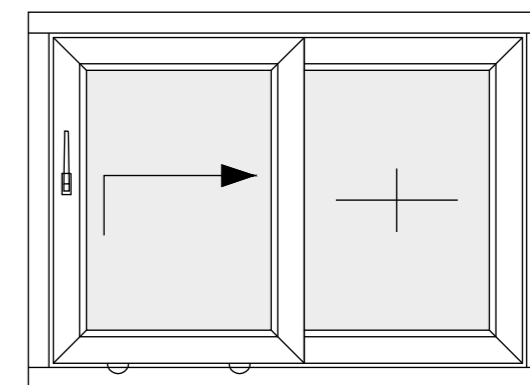

A

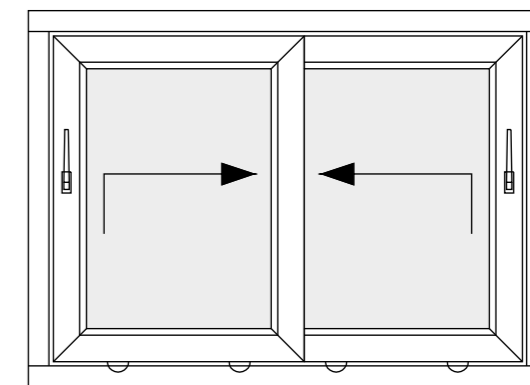

D

- Schemat
- Schéma
- Schema
- Schema
- Schema

EASY SLIDE

MULTI SLIDE

SMART SLIDE

HST 70

HST 85

MULTI SLIDE

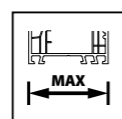

170

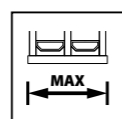

33

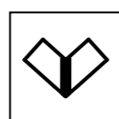

V SUPER SOLUTION



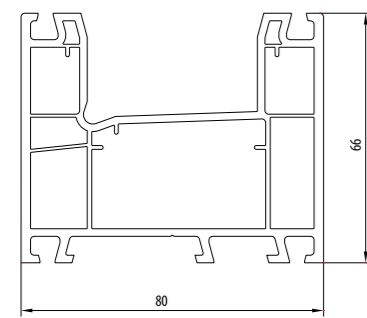

100090

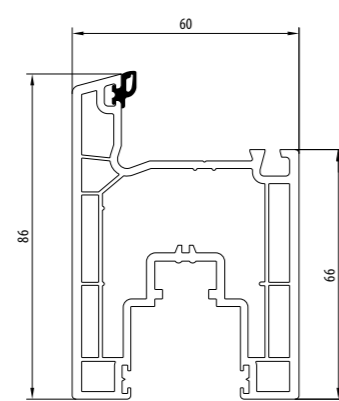

100092

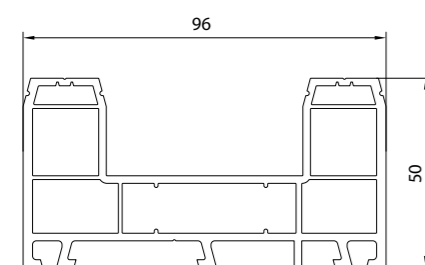

100097

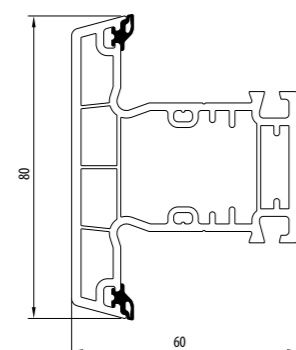



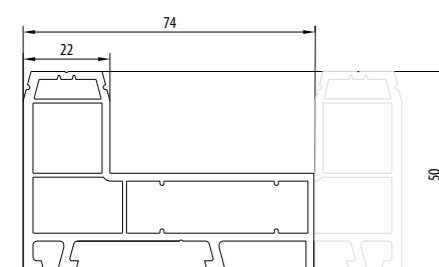

120041

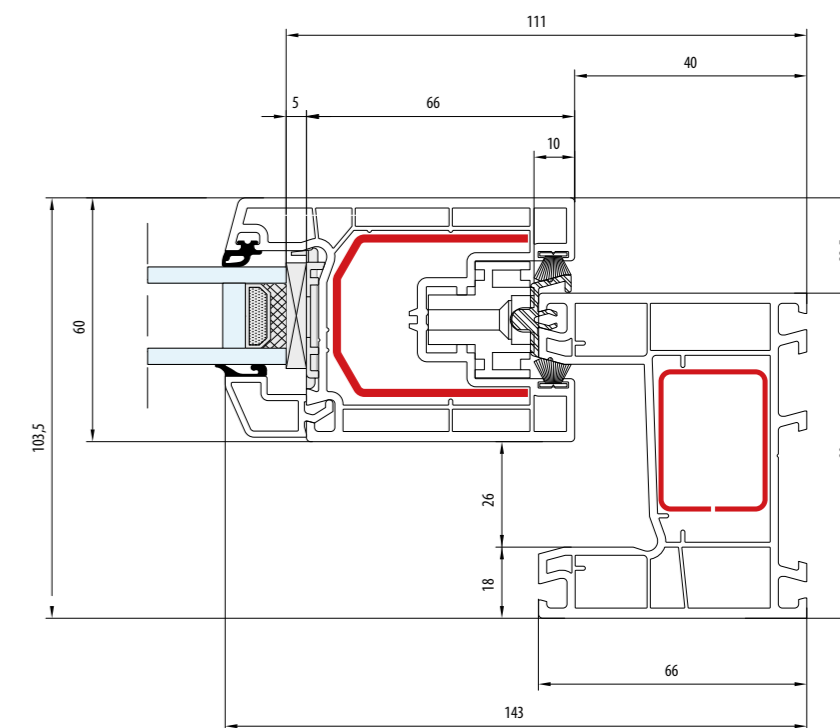
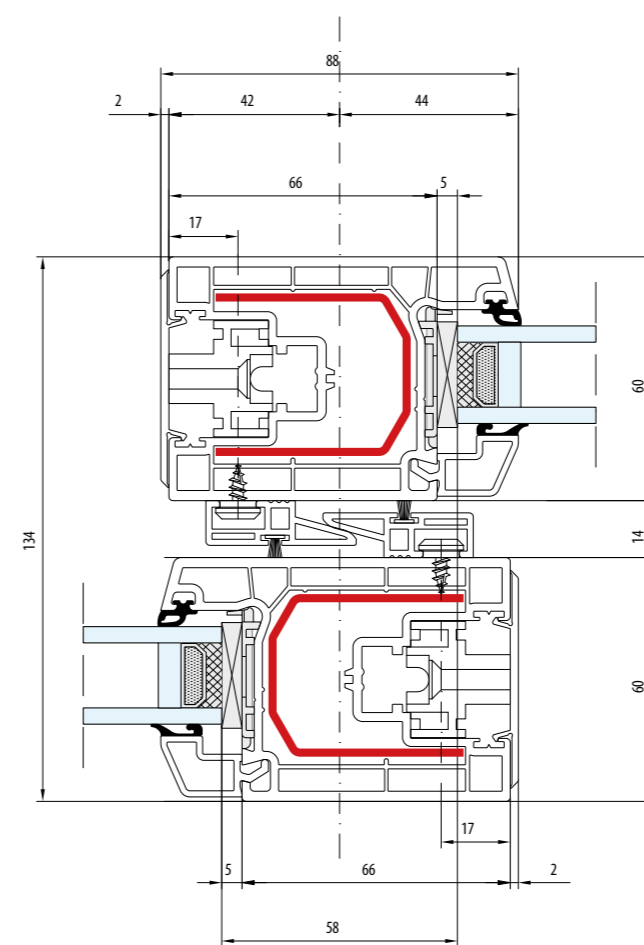
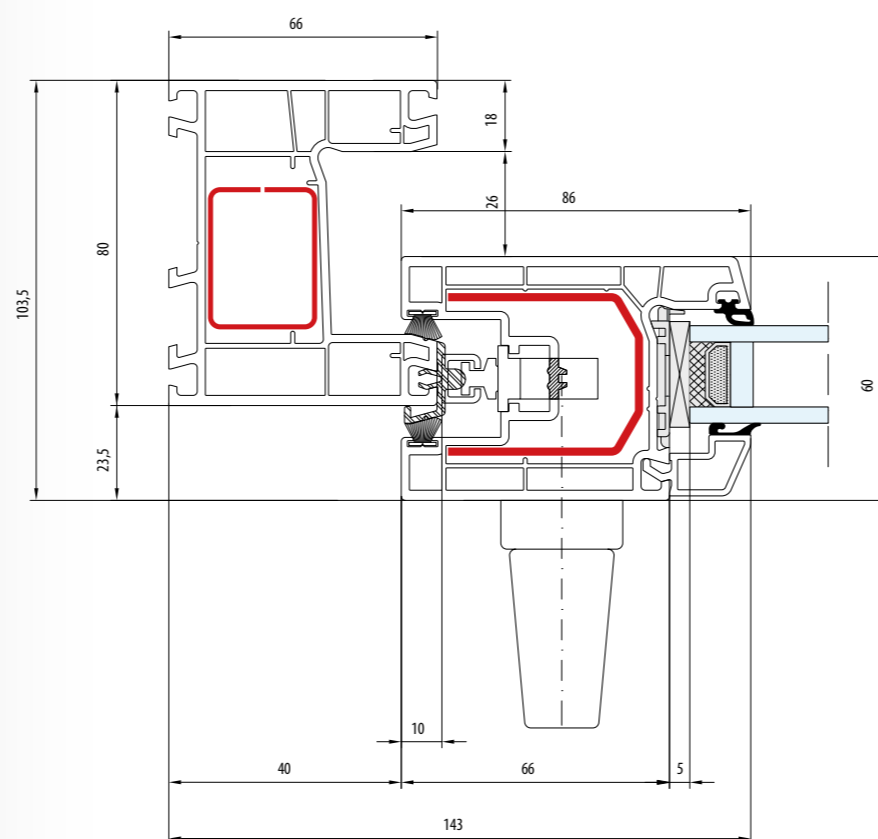

100098



-  Schemat A - Przekrój poziomy · Rama: 66 mm · Skrzydło: 86 mm
-  Schéma A - Coupe horizontale · Dormant: 66 mm · Vantail: 86 mm
-  Schema A - Doorsnede horizontaal · Frame: 66 mm · Sash: 86 mm
-  Schema A - Wagerechter Schnitt · Rahmen: 66 mm · Flügel: 86 mm
-  Schema A - Sezione orizzontale · Telaio: 66 mm · Anta: 86 mm

1:2

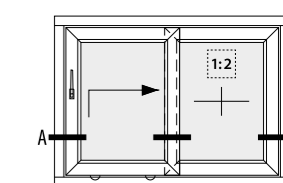

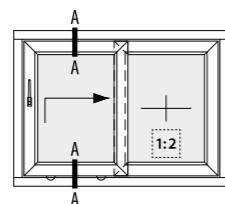
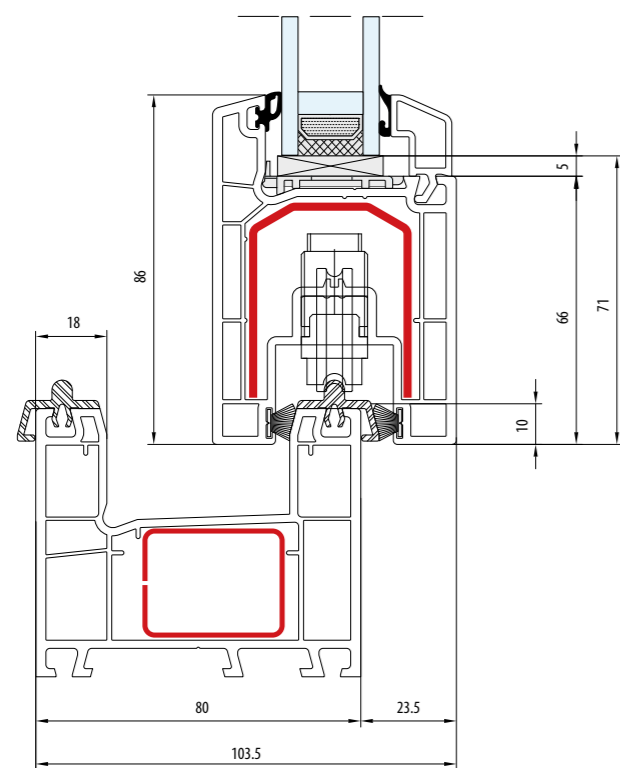
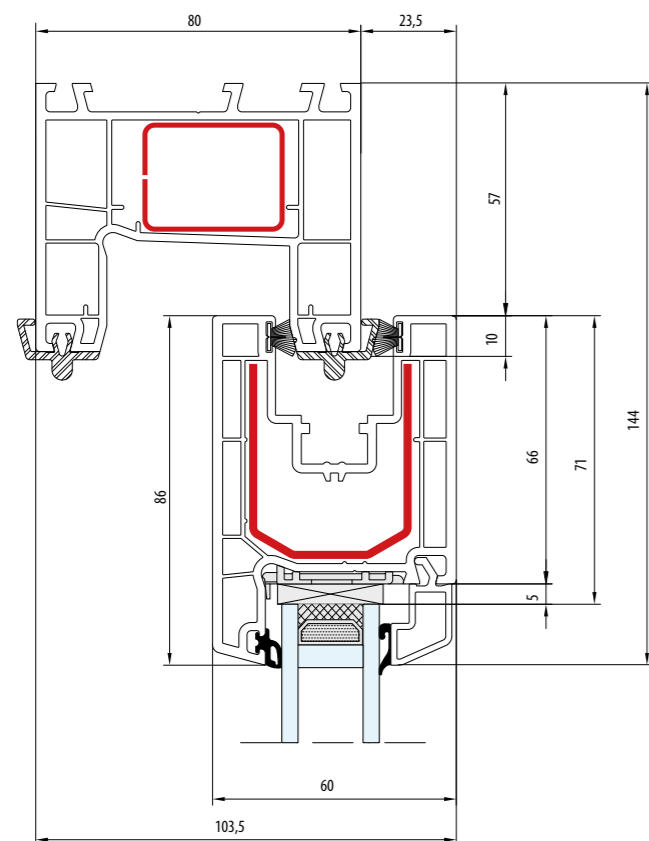

- Schemat A - Przekrój pionowy · Rama: 66 mm · Skrzydło: 86 mm
- Schéma A - Coupe verticale · Dormant: 66 mm · Vantail: 86 mm
- Schema A - Doorsnede verticaal · Frame: 66 mm · Sash: 86 mm
- Schema A - Senkrechter Schnitt · Rahmen: 66 mm · Flügel: 86 mm
- Schema A - Sezione verticale · Telaio: 66 mm · Anta: 86 mm

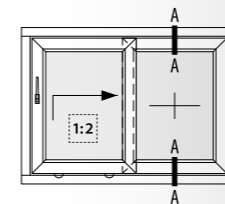
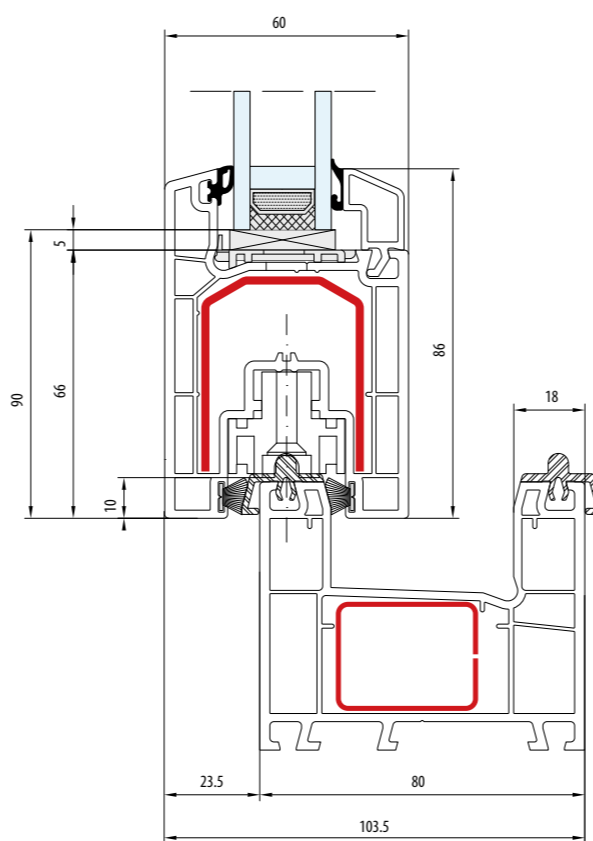
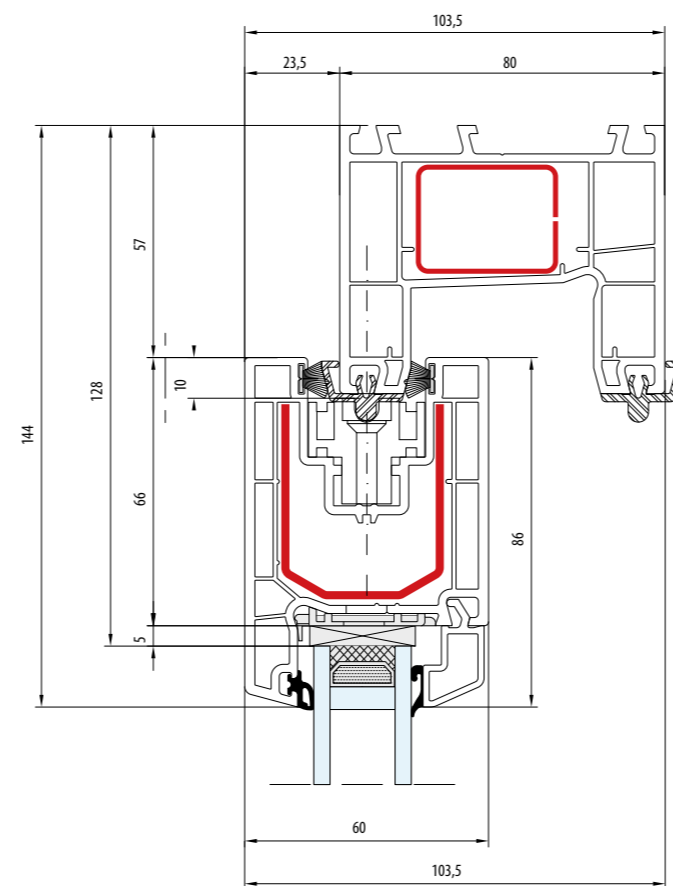

- Schemat A - Przekrój pionowy · Rama: 66 mm · Skrzydło: 86 mm
- Schéma A - Coupe verticale · Dormant: 66 mm · Vantail: 86 mm
- Schema A - Doorsnede verticaal · Frame: 66 mm · Sash: 86 mm
- Schema A - Senkrechter Schnitt · Rahmen: 66 mm · Flügel: 86 mm
- Schema A - Sezione verticale · Telaio: 66 mm · Anta: 86 mm

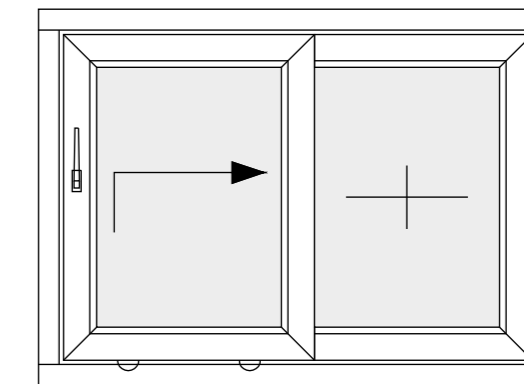

A

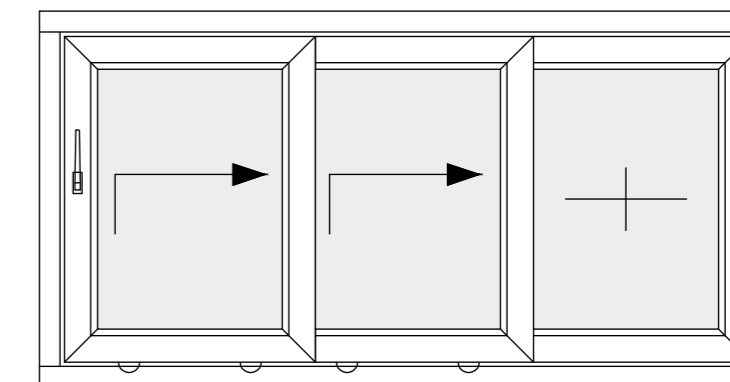

An

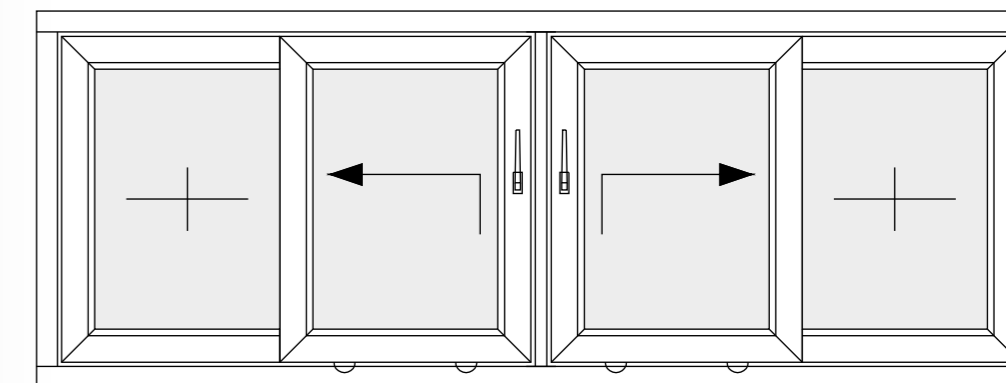

C

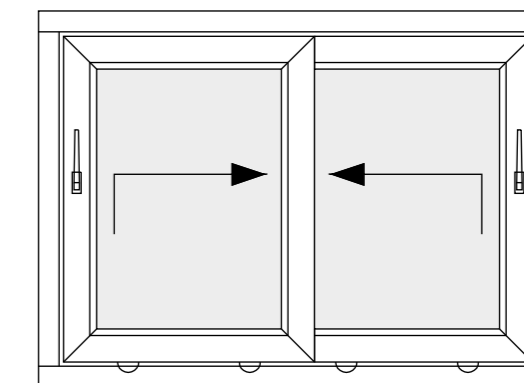

D

- Schemat
- Schéma
- Schema
- Schema
- Schema

SMART SLIDE

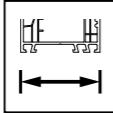
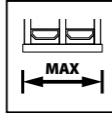
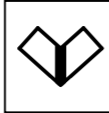

		
140	42	V SUPER SOLUTION



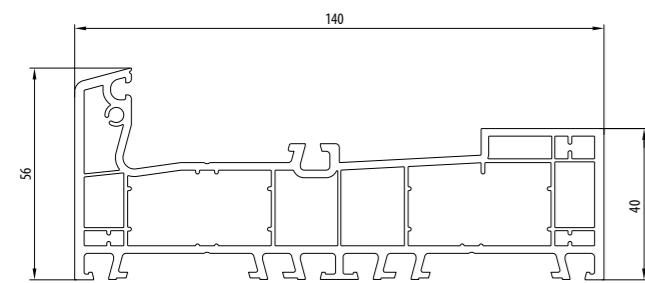

100091

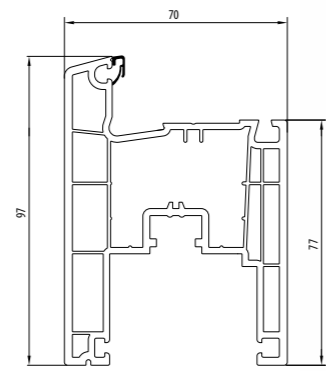

100094

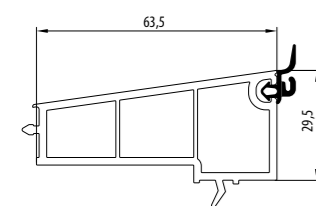

100291

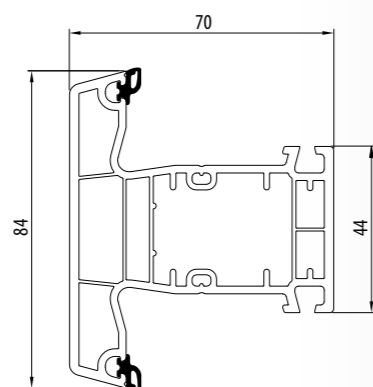



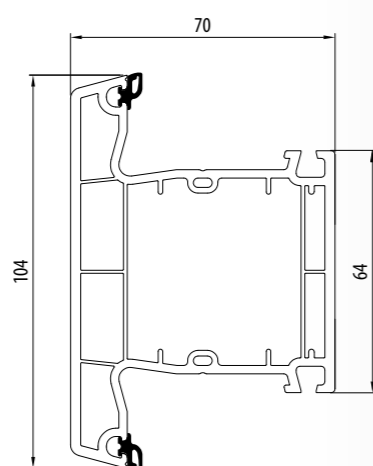

140x41

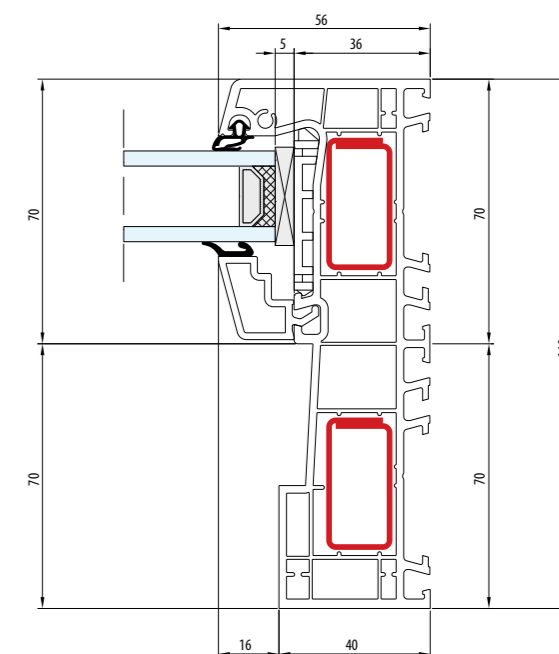
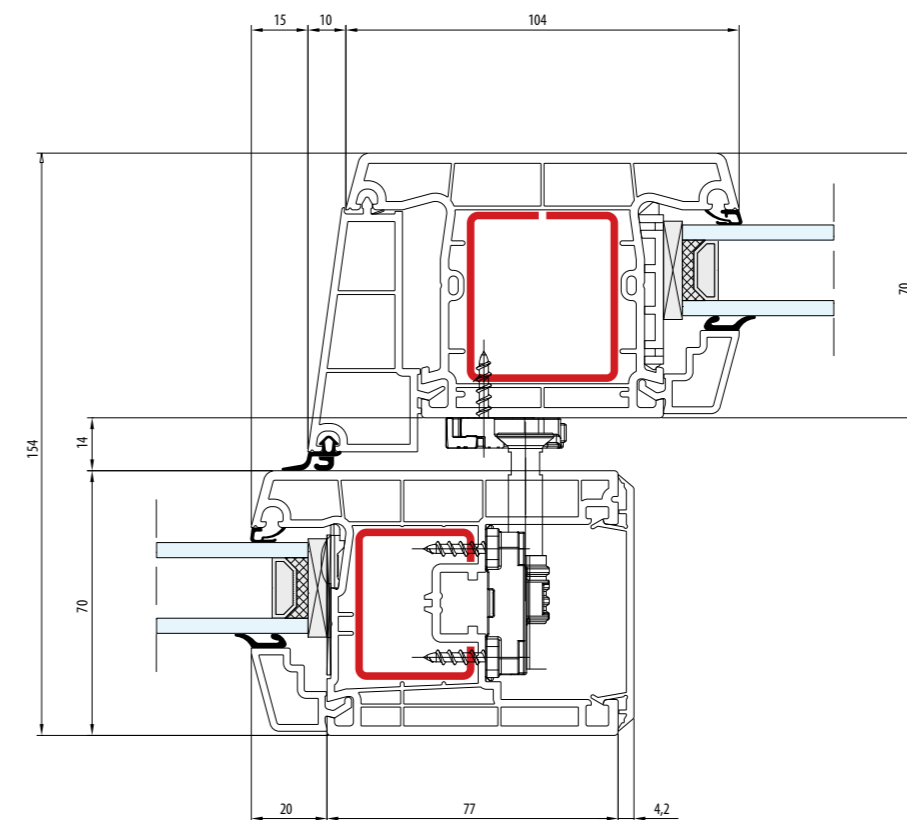
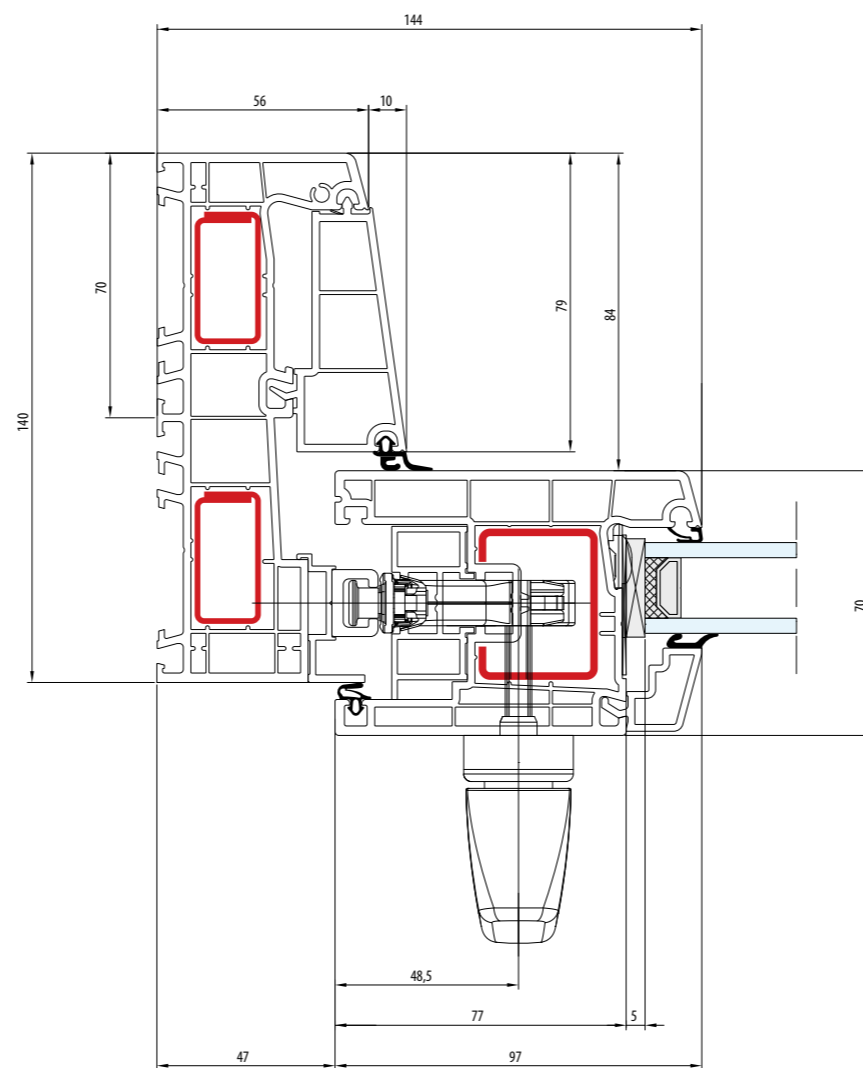

140x45



-  Schemat A - Przekrój poziomy · Rama: 56 mm · Skrzydło: 97 mm
-  Schéma A - Coupe horizontale · Dormant: 56 mm · Vantail: 97 mm
-  Schema A - Doorsnede horizontaal · Frame: 56 mm · Sash: 97 mm
-  Schema A - Wagerechter Schnitt · Rahmen: 56 mm · Flügel: 97 mm
-  Schema A - Sezione orizzontale · Telaio: 56 mm · Anta: 97 mm

1:2

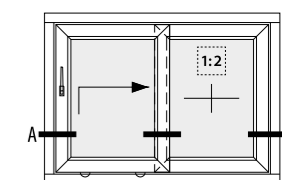

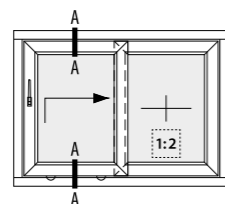
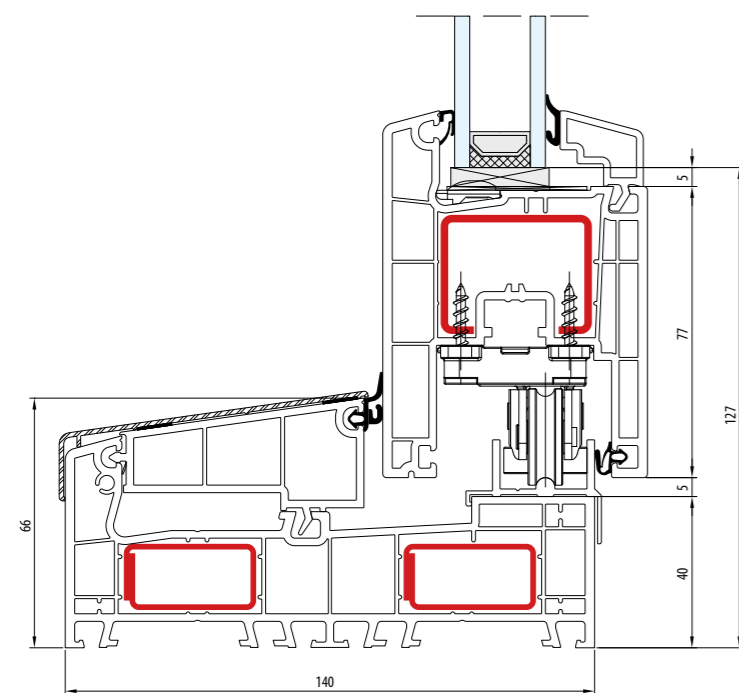
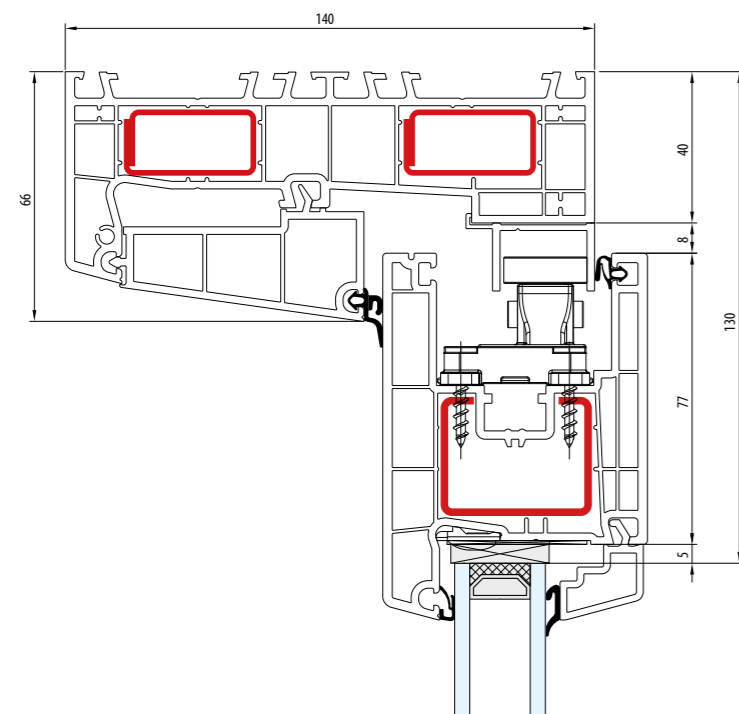

- Schemat A - Przekrój pionowy · Rama: 56 mm · Skrzydło: 97 mm
- Schéma A - Coupe verticale · Dormant: 56 mm · Vantail: 97 mm
- Schema A - Doorsnede verticaal · Frame: 56 mm · Sash: 97 mm
- Schema A - Senkrechter Schnitt · Rahmen: 56 mm · Flügel: 97 mm
- Schema A - Sezione verticale · Telaio: 56 mm · Anta: 97 mm

EASY SLIDE

MULTI SLIDE

SMART SLIDE

HST 70

HST 85

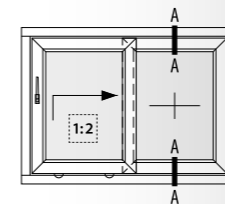
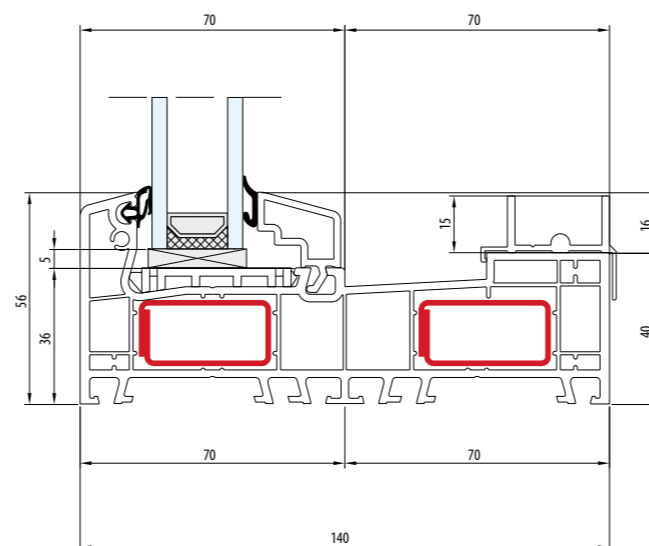
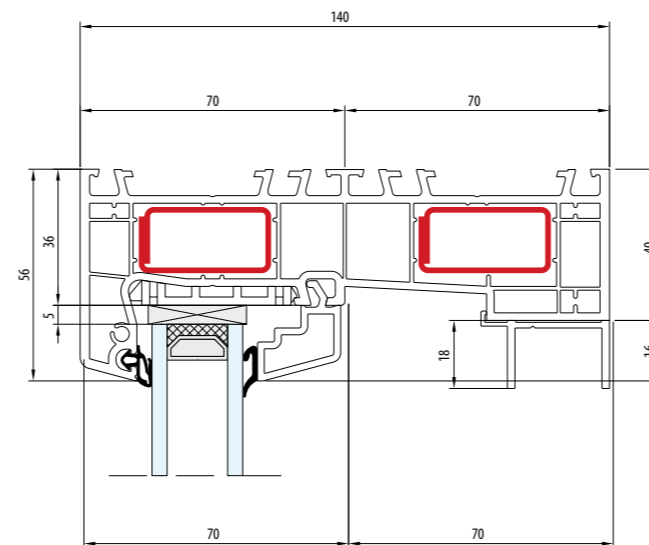

- Schemat A - Przekrój pionowy · Rama: 56 mm · Skrzydło: 97 mm
- Schéma A - Coupe verticale · Dormant: 56 mm · Vantail: 97 mm
- Schema A - Doorsnede verticaal · Frame: 56 mm · Sash: 97 mm
- Schema A - Senkrechter Schnitt · Rahmen: 56 mm · Flügel: 97 mm
- Schema A - Sezione verticale · Telaio: 56 mm · Anta: 97 mm

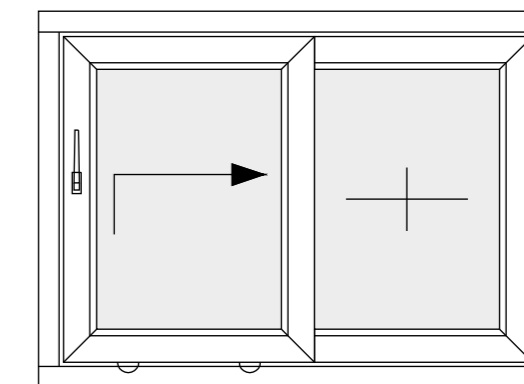

A

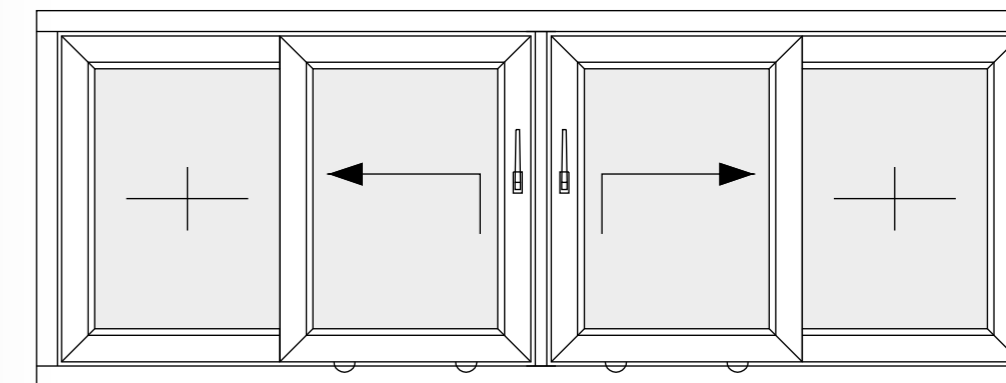

C

- Schemat
- Schéma
- Schema
- Schema
- Schema

EASY SLIDE

MULTI SLIDE

SMART SLIDE

HST 70

HST 85

HST 70

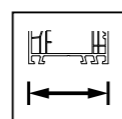
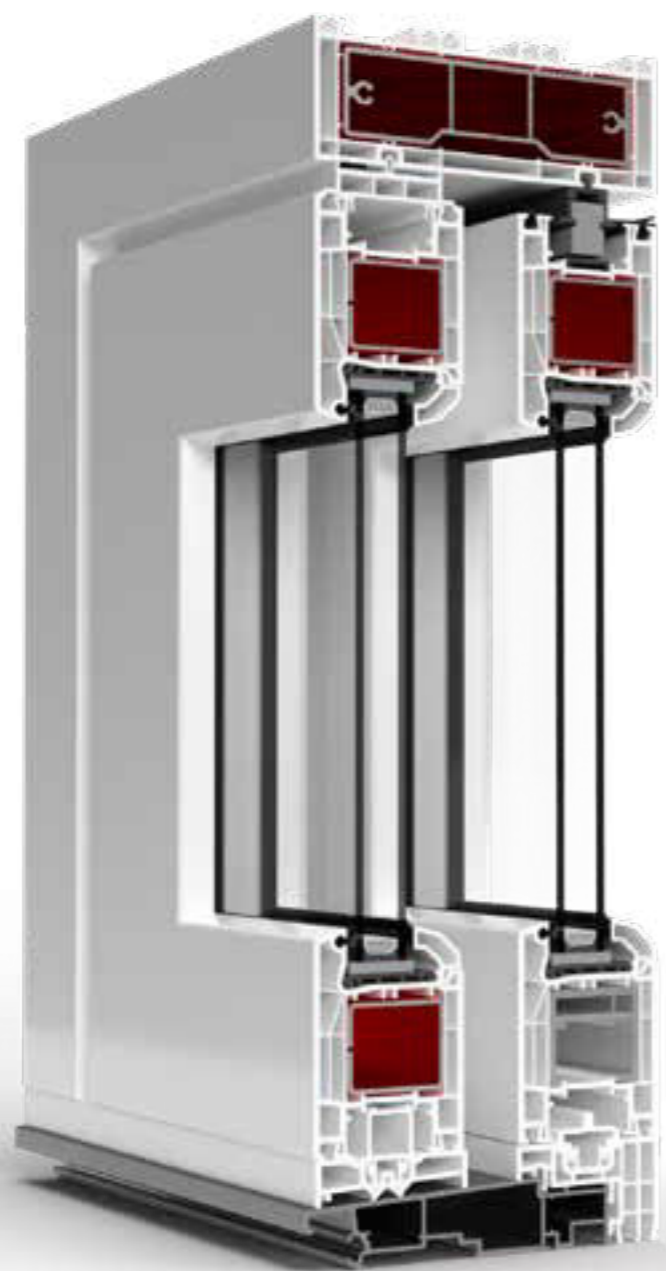

167

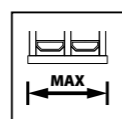

42

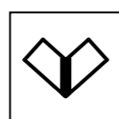

V SUPER SOLUTION



EASY SLIDE

MULTI SLIDE

SMART SLIDE

HST 70

HST 85

EASY SLIDE

MULTI SLIDE

SMART SLIDE

HST 70

HST 85

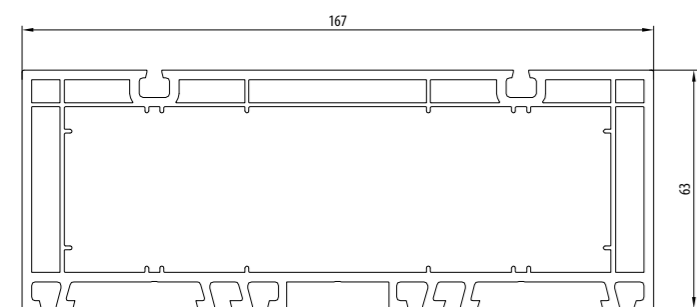

140x80

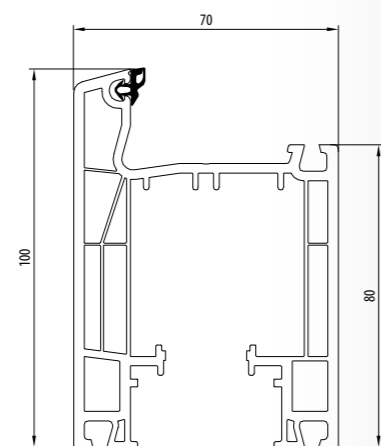

140x81

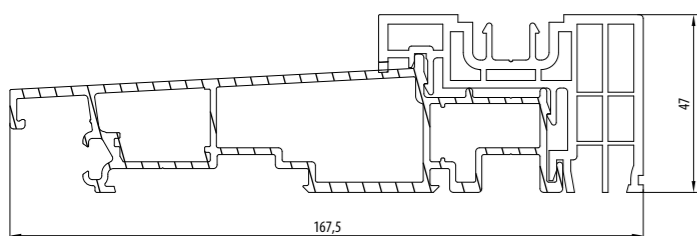

GU-47

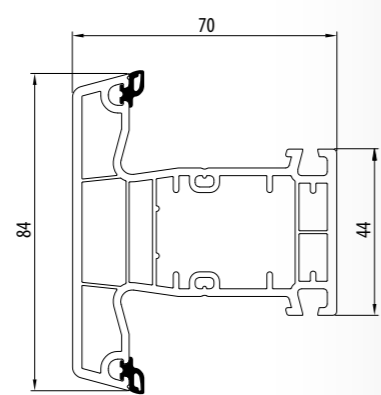

140x41

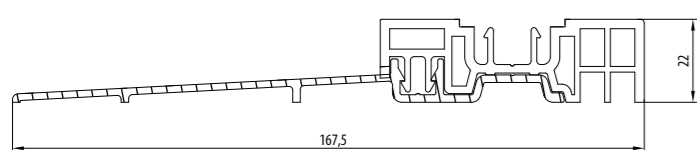

Flatstep

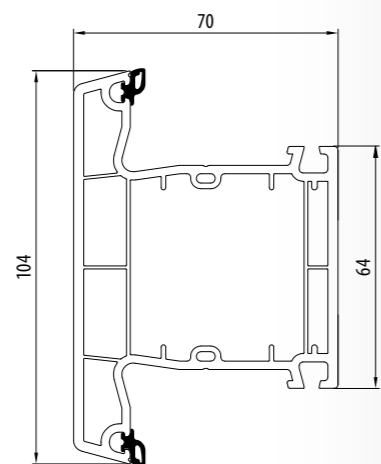

140x45

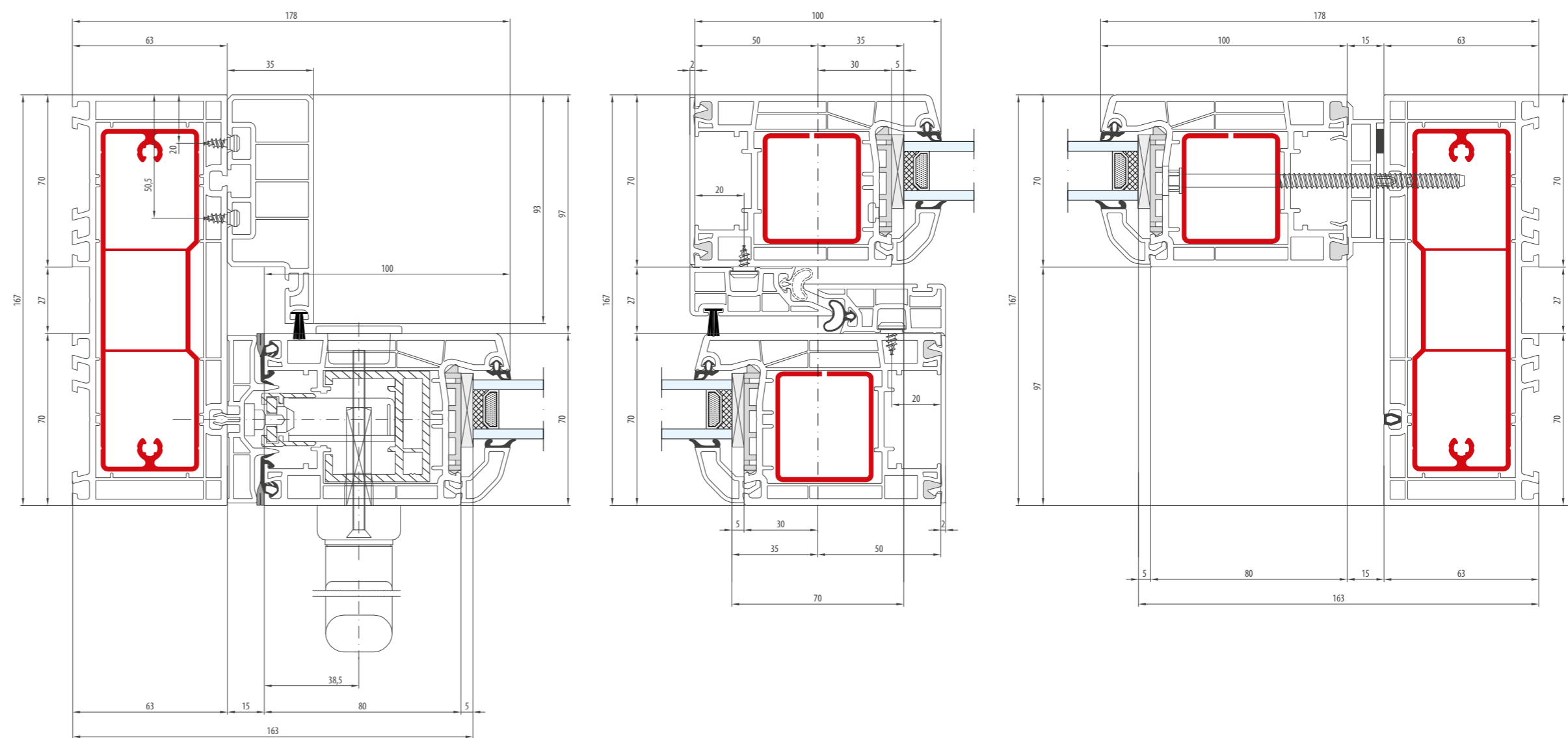

■ Schemat A - Przekrój poziomy - Rama: 63 mm · Skrzydło: 100 mm

■ Schéma A - Coupe horizontale - Dormant: 63 mm · Vantail: 100 mm

■ Schema A - Doorsnede horizontaal - Frame: 63 mm · Sash: 100 mm

■ Schema A - Wagerechter Schnitt - Rahmen: 63 mm · Flügel: 100 mm

■ Schema A - Sezione orizzontale - Telaio: 63 mm · Anta: 100 mm

1:2

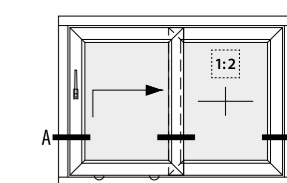

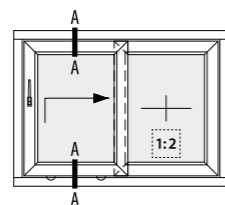
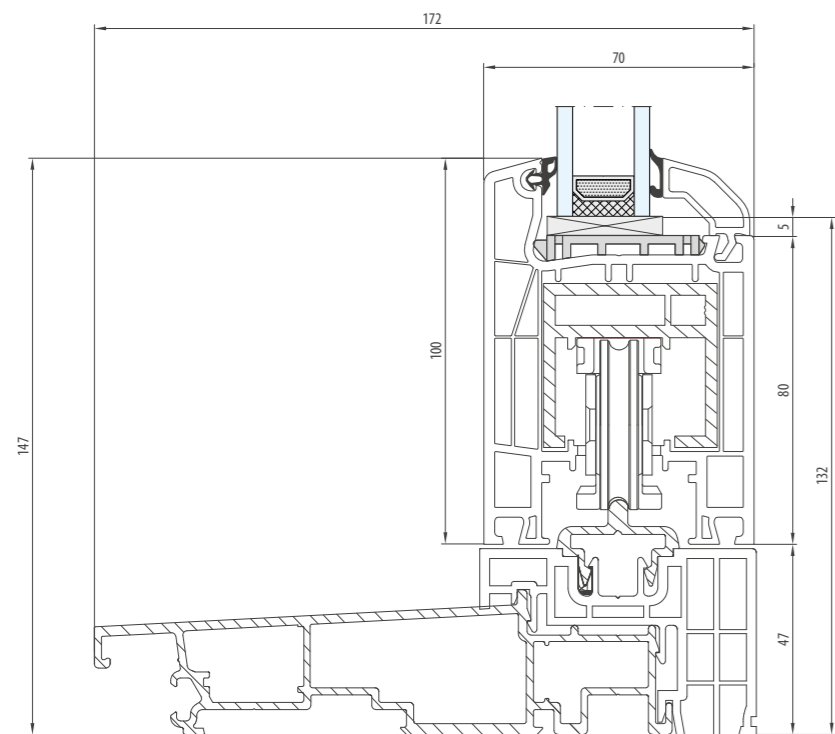
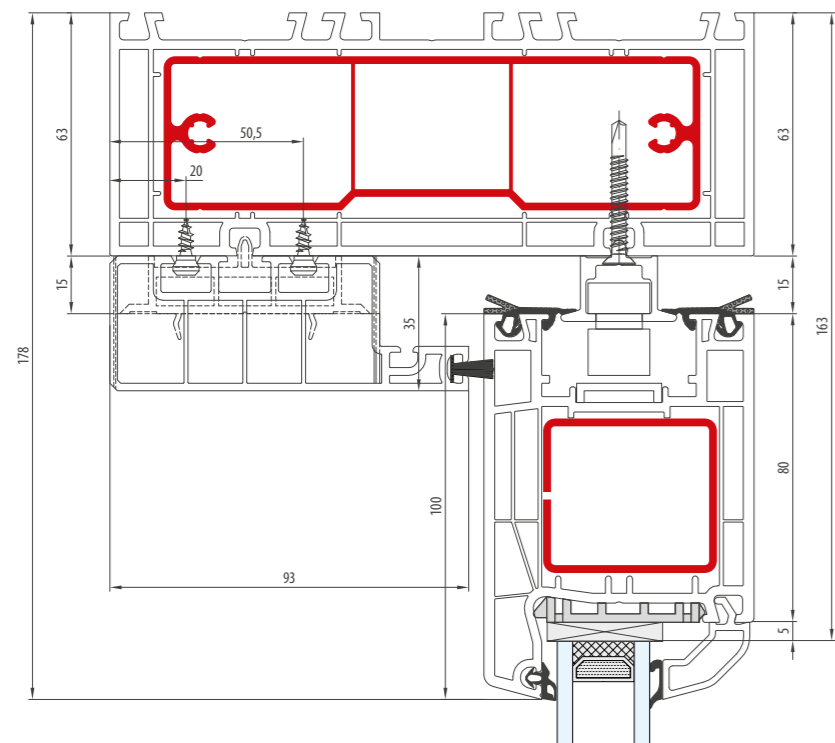

- Schemat A - Przekrój pionowy · Próg: 47 mm · Skrzydło: 100 mm
- Schéma A - Coupe verticale · Seuil: 47 mm · Vantail: 100 mm
- Schema A - Doorsnede verticaal · Doorstep: 47 mm · Sash: 100 mm
- Schema A - Senkrechter Schnitt · Schwelle: 47 mm · Flügel: 100 mm
- Schema A - Sezione verticale · Soglia: 47 mm · Anta: 100 mm

EASY SLIDE

MULTI SLIDE

SMART SLIDE

HST 70

HST 85

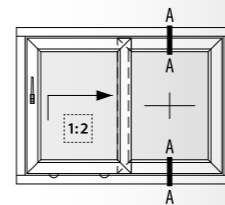
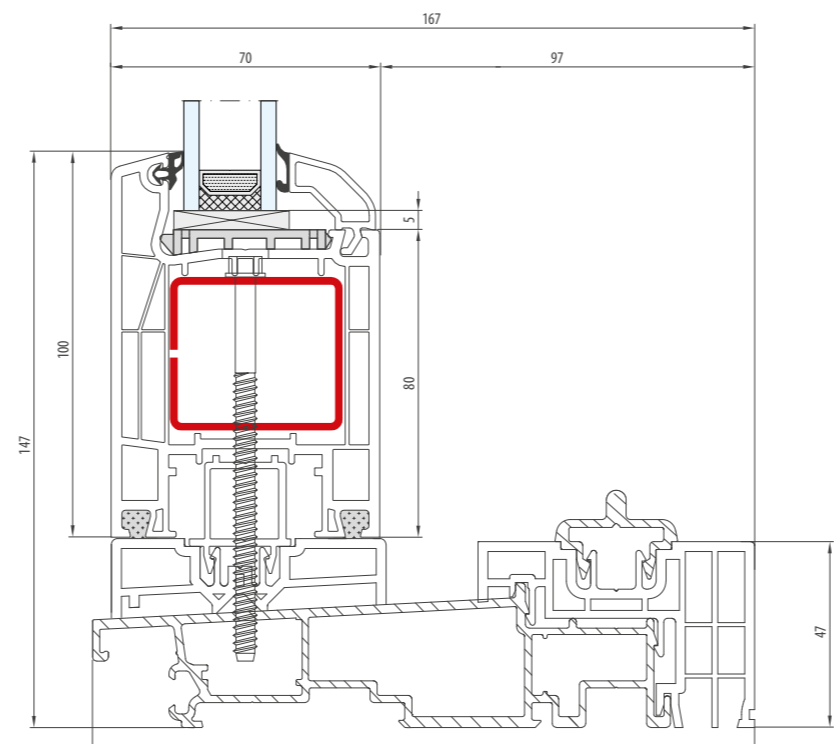
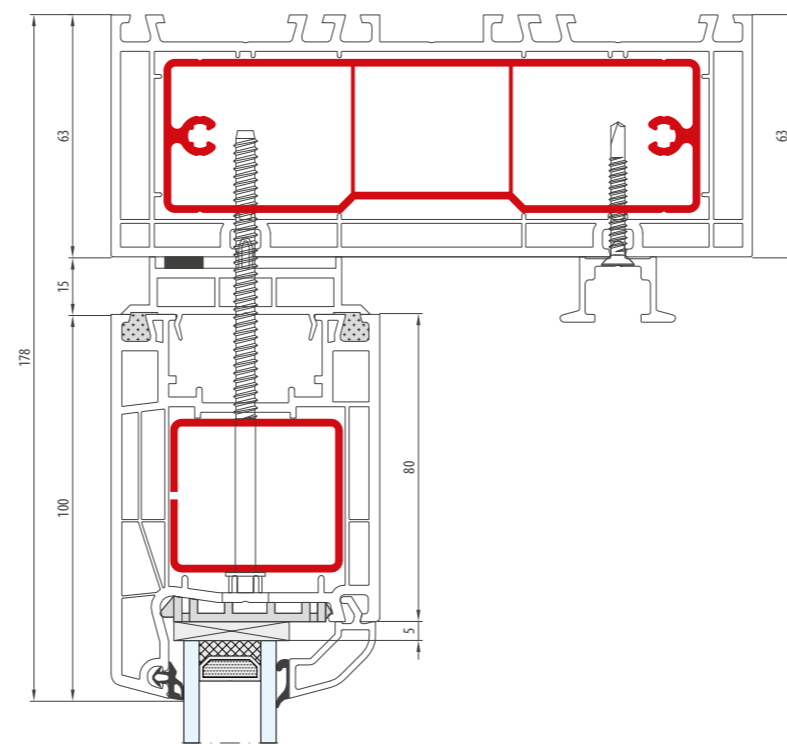

- Schemat A - Przekrój pionowy · Próg: 47 mm · Skrzydło: 100 mm
- Schéma A - Coupe verticale · Seuil: 47 mm · Vantail: 100 mm
- Schema A - Doorsnede verticaal · Doorstep: 47 mm · Sash: 100 mm
- Schema A - Senkrechter Schnitt · Schwelle: 47 mm · Flügel: 100 mm
- Schema A - Sezione verticale · Soglia: 47 mm · Anta: 100 mm

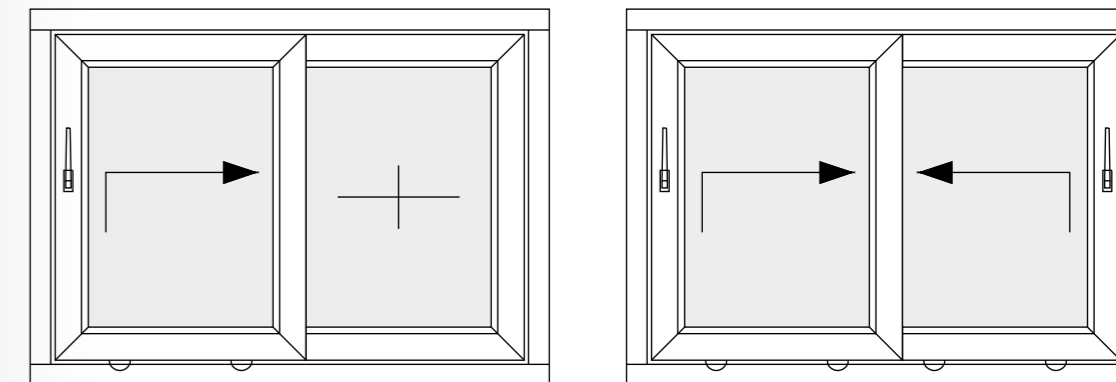

A

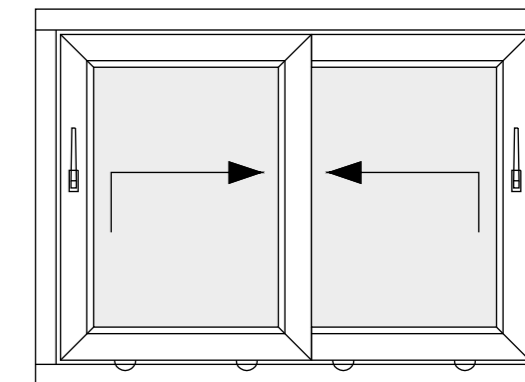

D

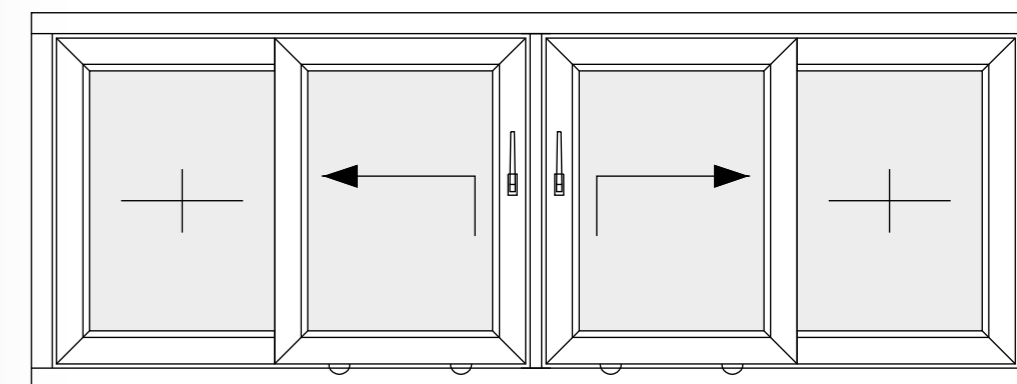

C

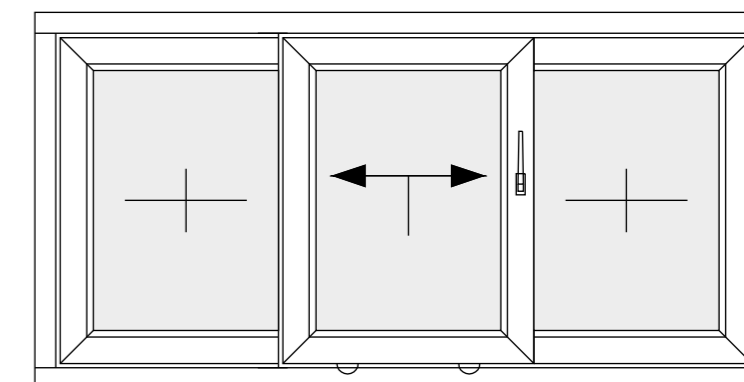

G

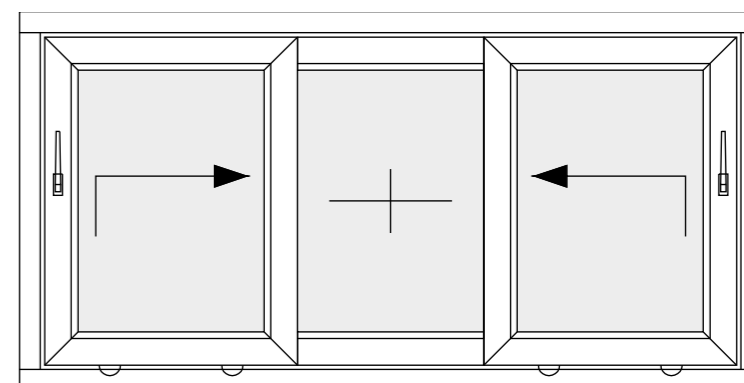

K

- Schemat
- Schéma
- Schema
- Schema
- Schema

EASY SLIDE

MULTI SLIDE

SMART SLIDE

HST 70

HST 85

HST 85

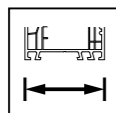

197

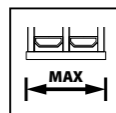

52

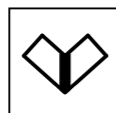

V-SUPER SOLUTION



ALU



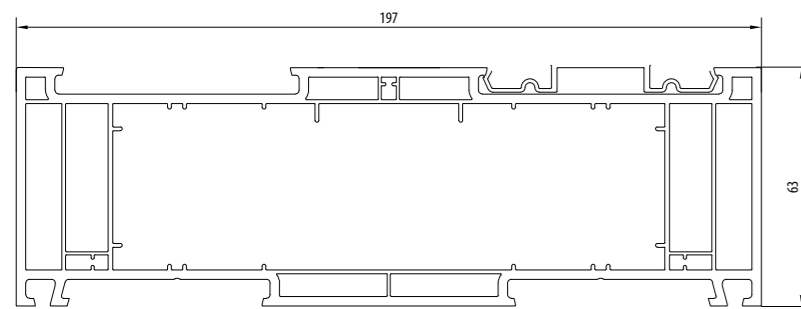

CL ALU 170x80

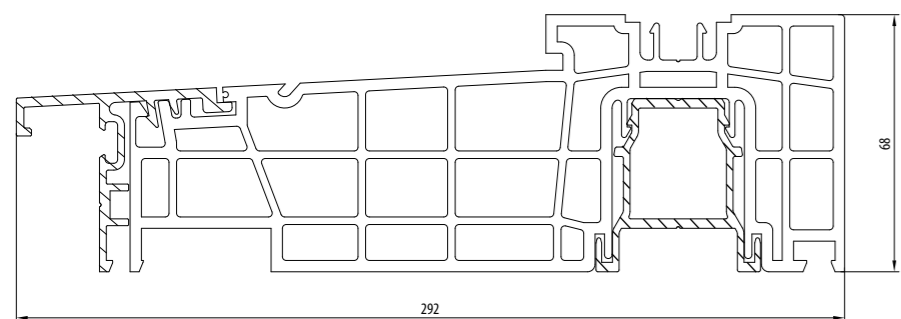

Thermostep

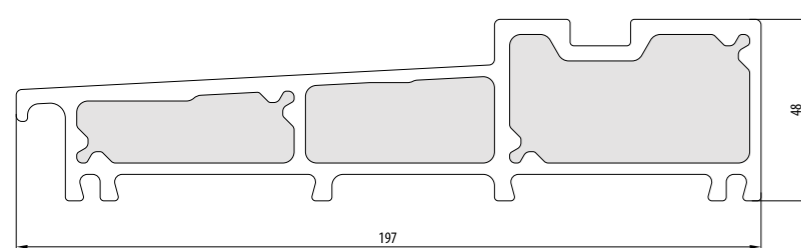

Premium

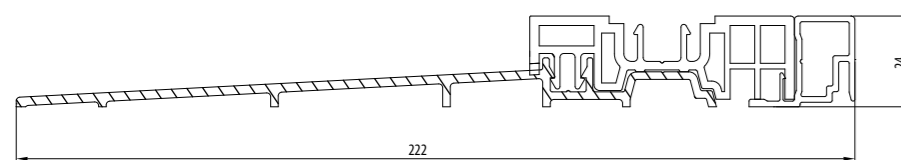

Flatstep

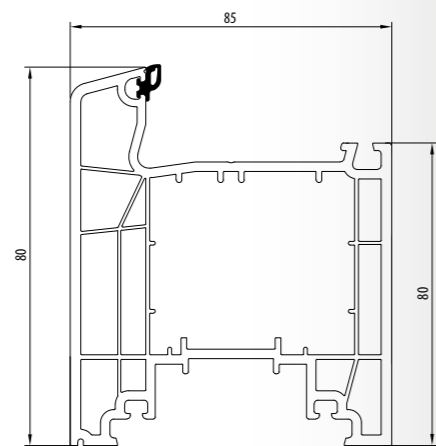



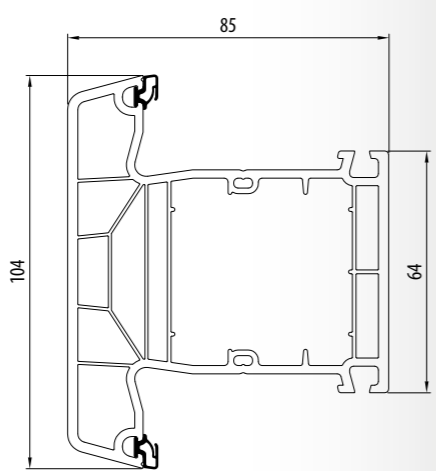

CL ALU 170x81

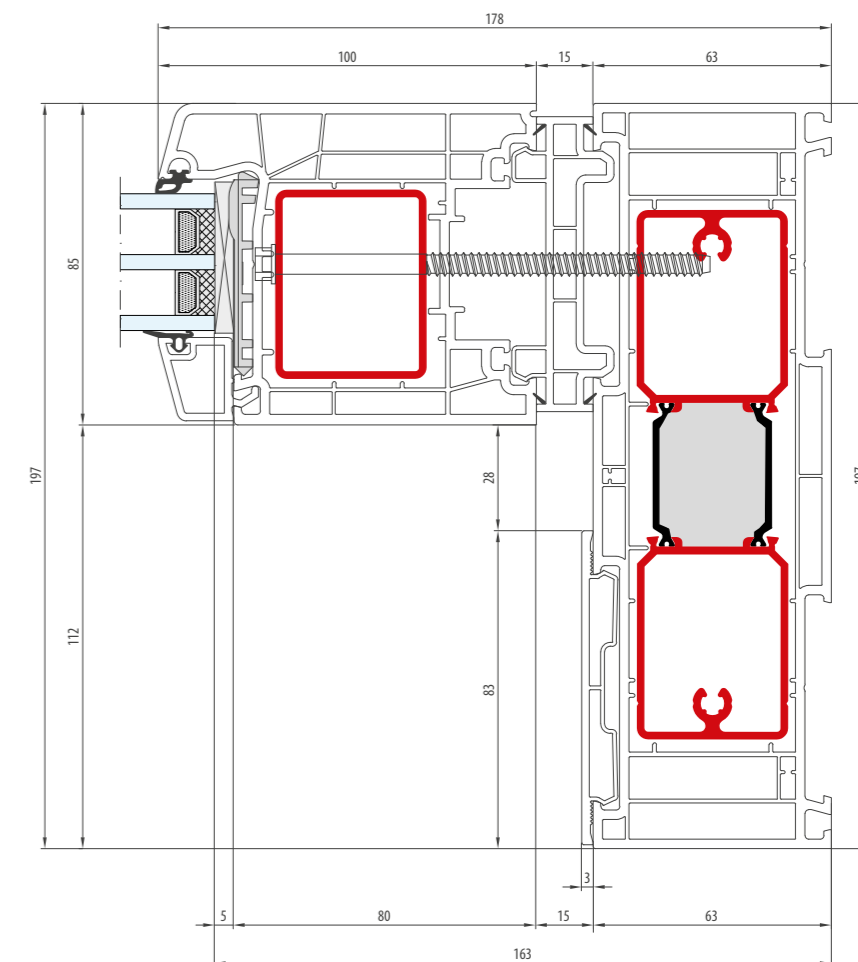
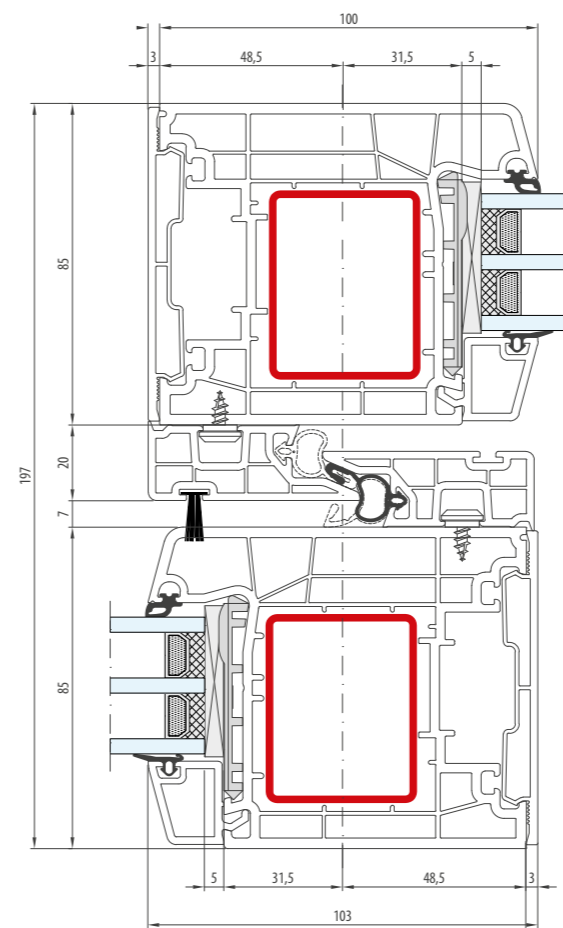
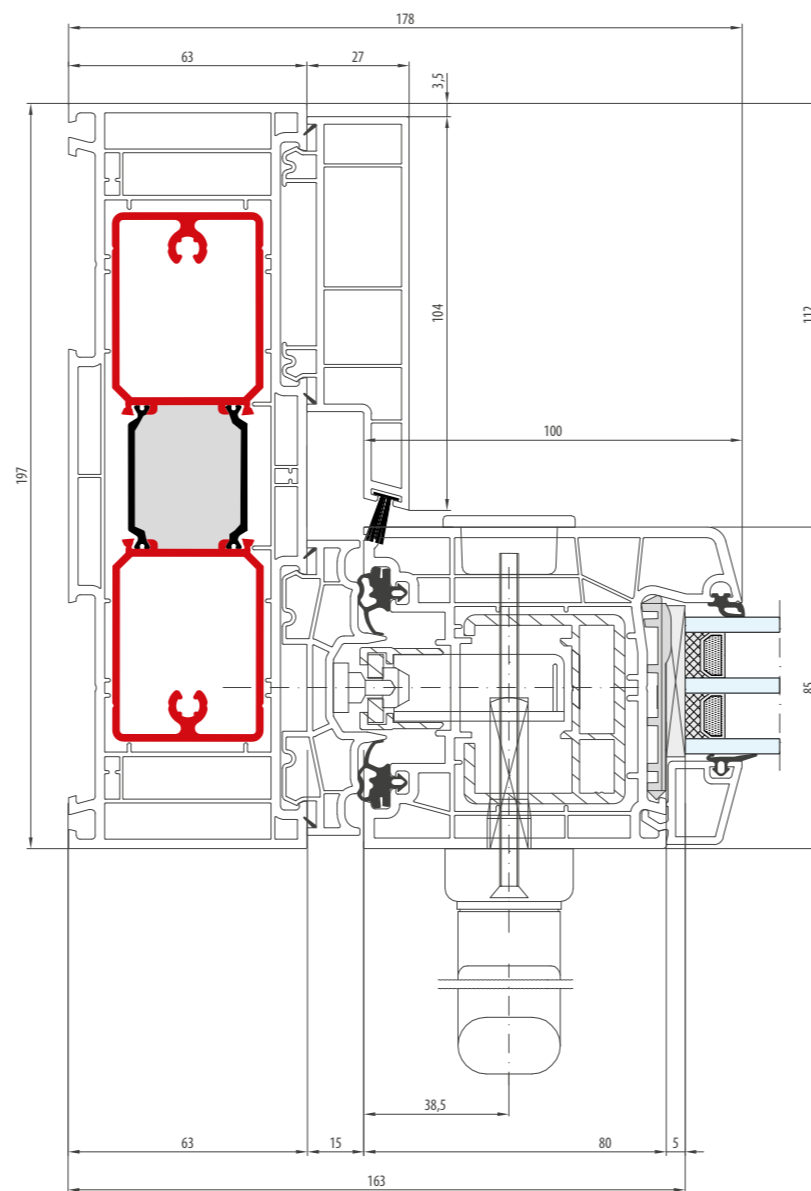

CL ALU 170x44



-  Schemat A - Przekrój poziomy · Rama: 63 mm · Skrzydło: 100 mm
-  Schéma A - Coupe horizontale · Dormant: 63 mm · Vantail: 100 mm
-  Schema A - Doorsnede horizontaal · Frame: 63 mm · Sash: 100 mm
-  Schema A - Wagerechter Schnitt · Rahmen: 63 mm · Flügel: 100 mm
-  Schema A - Sezione orizzontale · Telaio: 63 mm · Anta: 100 mm

1:2

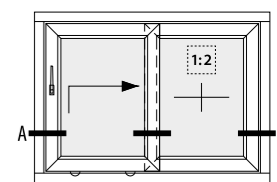

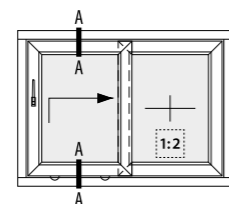
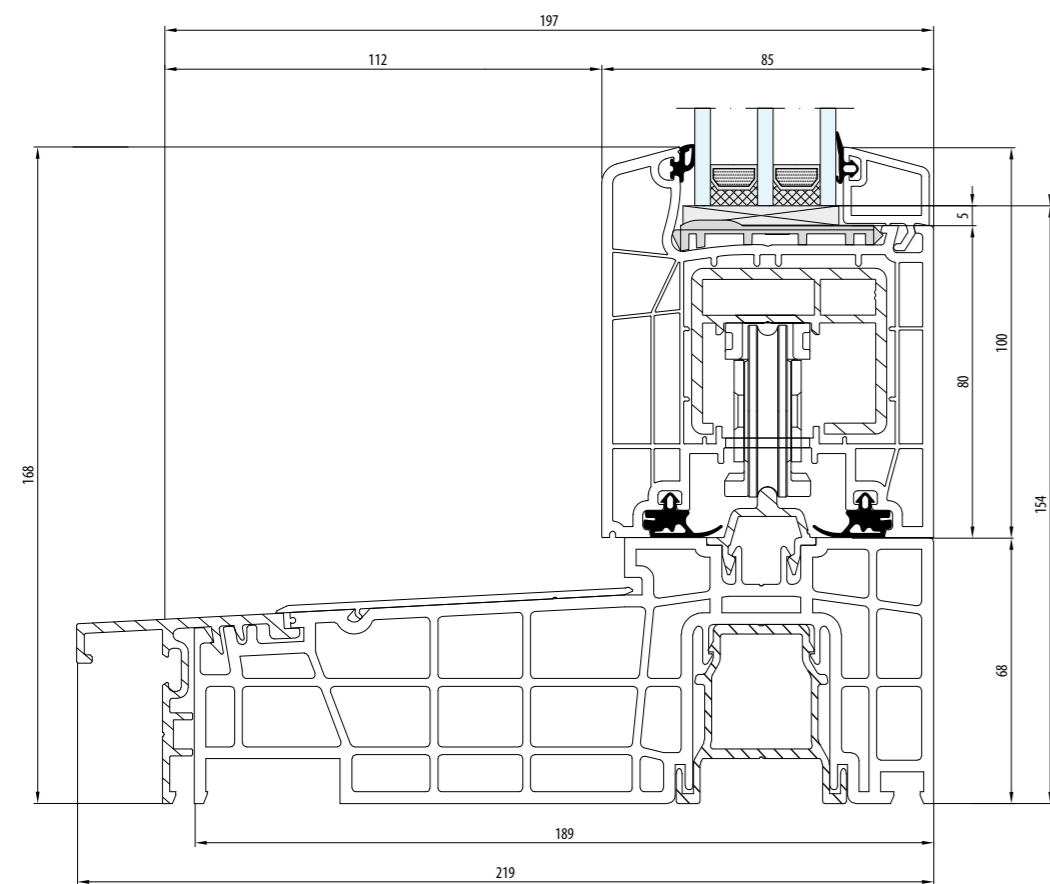
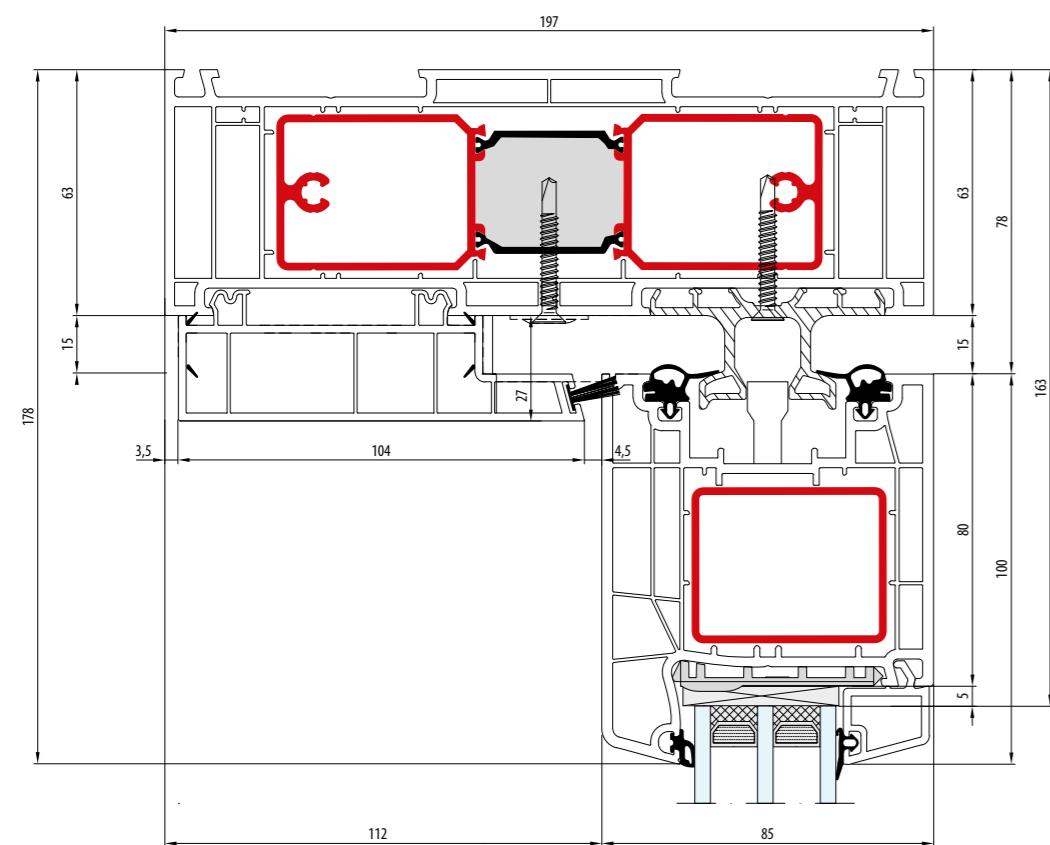

- Schemat A - Przekrój pionowy · Próg: 68 mm · Skrzydło: 100 mm
- Schéma A - Coupe verticale · Seuil: 68 mm · Vantail: 100 mm
- Schema A - Doorsnede verticaal · Doorstep: 68 mm · Sash: 100 mm
- Schema A - Senkrechter Schnitt · Schwelle: 68 mm · Flügel: 100 mm
- Schema A - Sezione verticale · Soglia: 68 mm · Anta: 100 mm

EASY SLIDE

MULTI SLIDE

SMART SLIDE

HST 70

HST 85

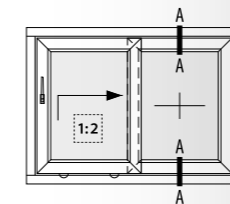
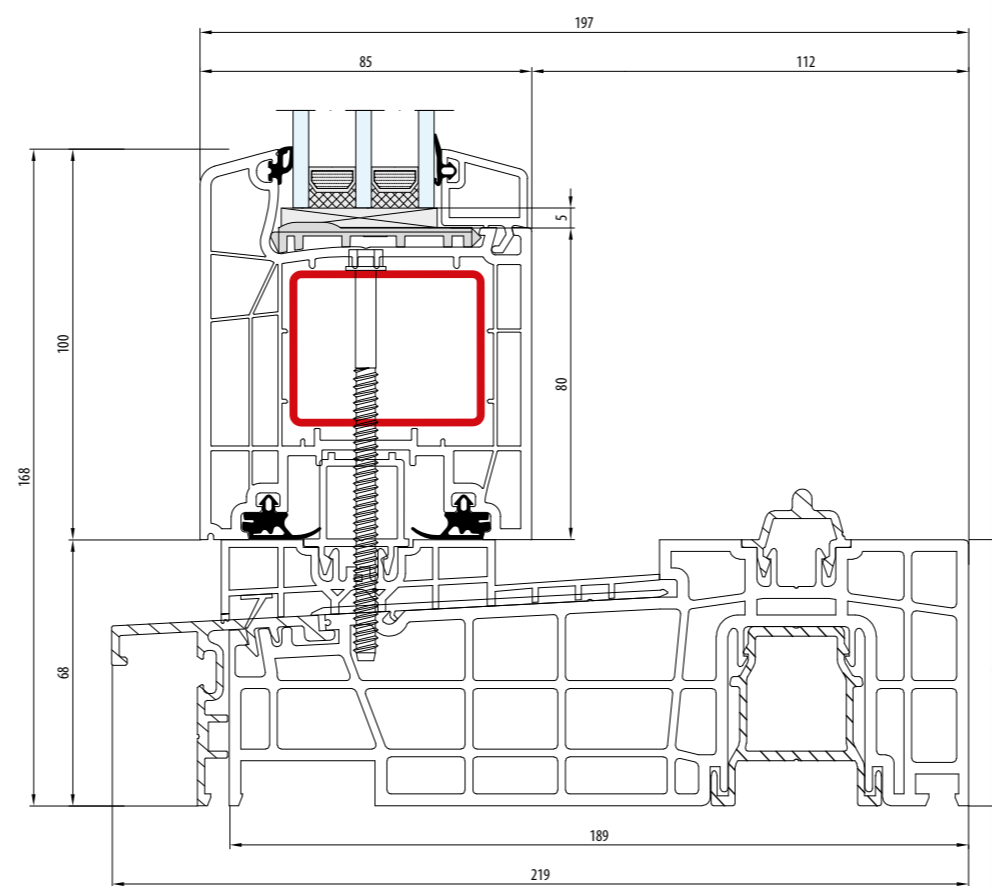
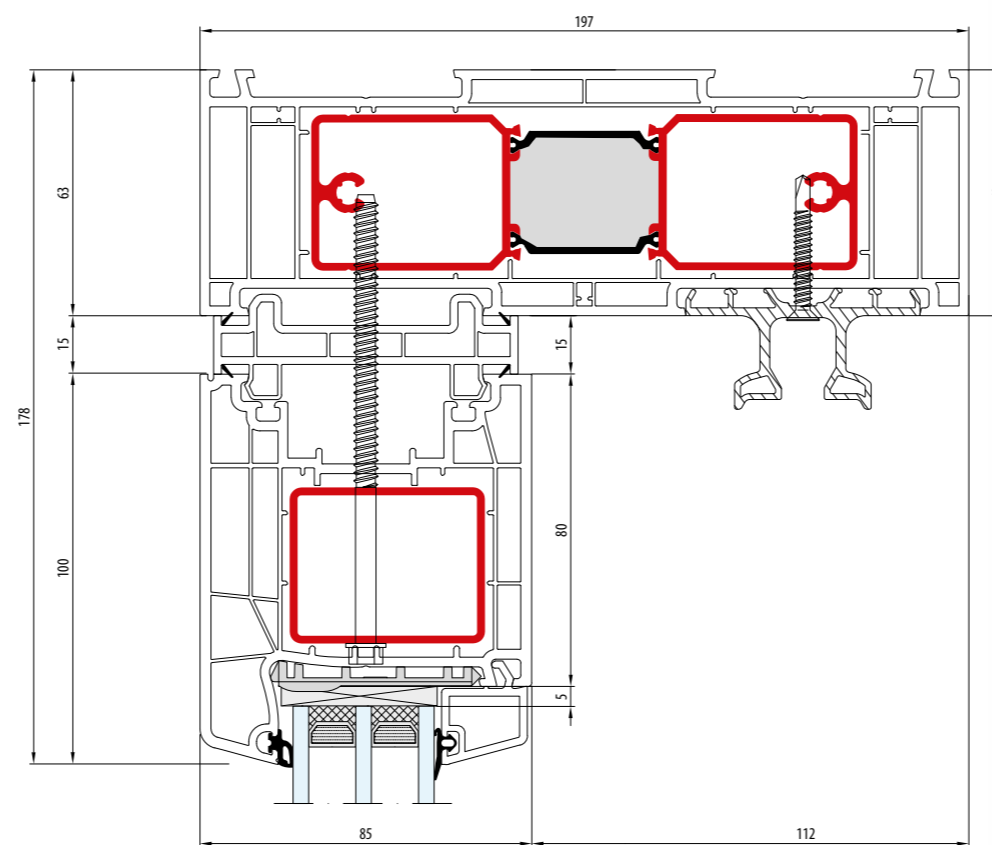

- Schemat A - Przekrój pionowy · Próg: 68 mm · Skrzydło: 100 mm
- Schéma A - Coupe verticale · Seuil: 68 mm · Vantail: 100 mm
- Schema A - Doorsnede verticaal · Doorstep: 68 mm · Sash: 100 mm
- Schema A - Senkrechter Schnitt · Schwelle: 68 mm · Flügel: 100 mm
- Schema A - Sezione verticale · Soglia: 68 mm · Anta: 100 mm

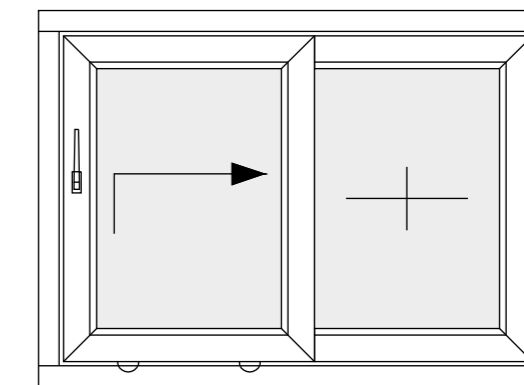

A

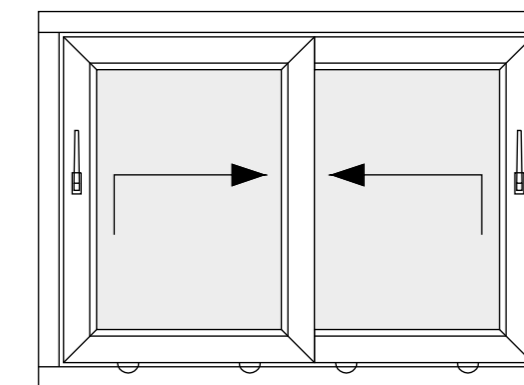

D

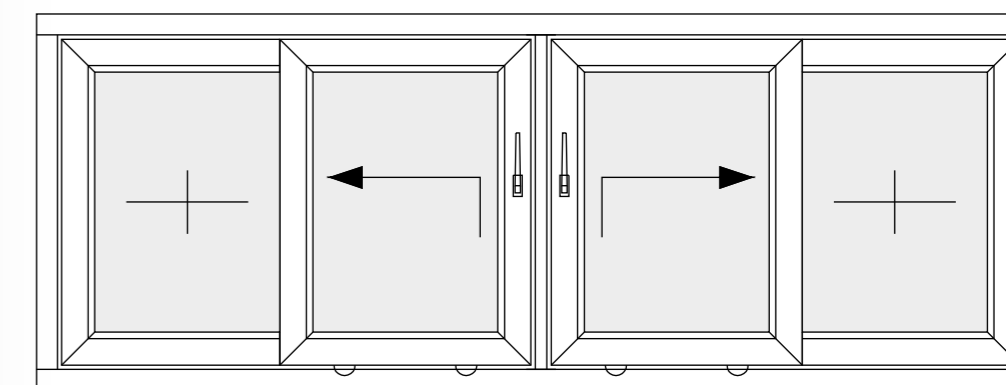

C

- Schemat
- Schéma
- Schema
- Schema
- Schema

EASY SLIDE

MULTI SLIDE

SMART SLIDE

HST 70

HST 85

EASY SLIDE





MULTI SLIDE

SMART SLIDE

HST 70

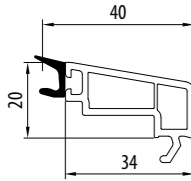
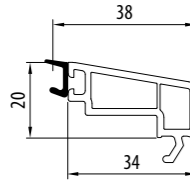
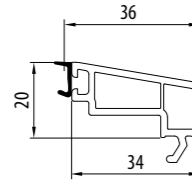
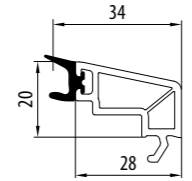
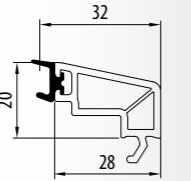
HST 85

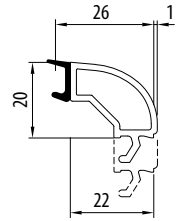
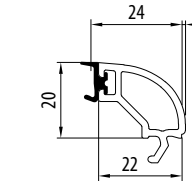
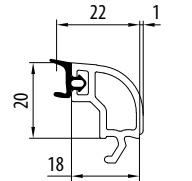
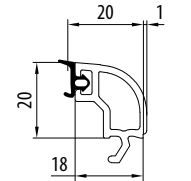
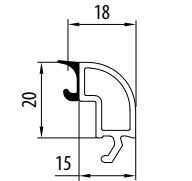
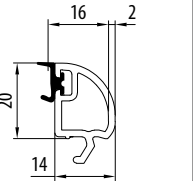
Standard

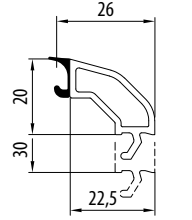
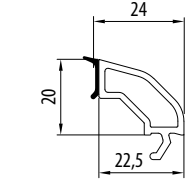
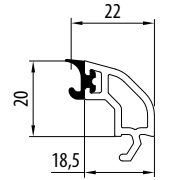
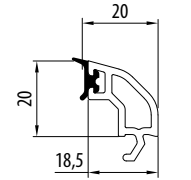
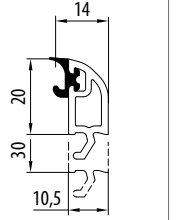
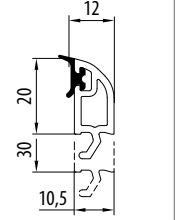
	d [mm]										
Ideal 4000 Ideal 5000 Nord-line (S) Blockprofil Monoblock Nordline Ideal 70/Cas HST 70 Smartslide	10 - 11	12 - 13	14 - 15	16 - 17	18 - 19						
Ideal 7000 Ideal 8000 Energeto 8000 Nord-line (R) HST 85	20 - 21	22 - 23	24 - 25	26 - 27	28 - 29						
Ideal 4000 > 140x27	17 - 18	19 - 20	21 - 22	23 - 24	25 - 26						
	 ■ 120740 □ 120770	 ■ 120840 □ 120870	 ■ 120640 □ 120670	 ■ 120738 □ 120768	 ■ 120838 □ 120868						
				 ■ 120850 □ 120880 ■ 130850 □ 130880	 ■ 120650 □ 120680	 ■ 120859 □ 120889	 ■ 120659 □ 120689	 ■ 140852 □ 140882	 ■ 120642 □ 120672		
				 ■ 120846 □ 120876 ■ 130856 □ 130886	 ■ 120646 □ 120676	 ■ 120847 □ 120877	 ■ 120647 □ 120677		 ■ 120849 □ 120879 ■ 130859 □ 130889	 ■ 120649 □ 120679 ■ 130659 □ 130689	

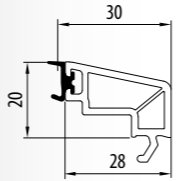
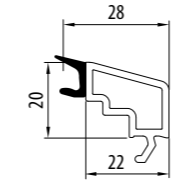
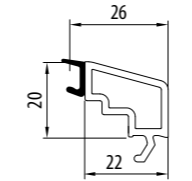
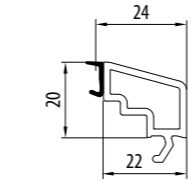
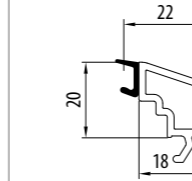
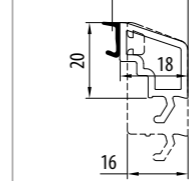
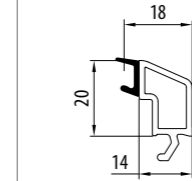
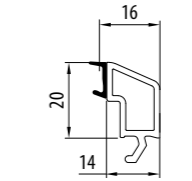
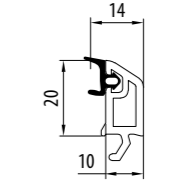
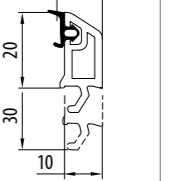
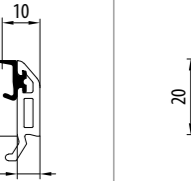
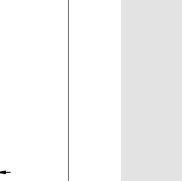
d [mm]												
20 - 21	22 - 23	24 - 25	26 - 27	28 - 29	30 - 31	32 - 33	34 - 35	36 - 37	38 - 39	40 - 41	42 - 43	
30 - 31	32 - 33	34 - 35	36 - 37	38 - 39	40 - 41	42 - 43	44 - 45	46 - 47	48 - 49	50 - 51	52 - 53	
27 - 28	29 - 30	31 - 32	33 - 34	35 - 36	37 - 38	39 - 40	41 - 42	43 - 44	45 - 46	47 - 48		
 ■ 120638 □ 120668	 ■ 120736 □ 120766	 ■ 120836 □ 120866	 ■ 120636 □ 120666	 ■ 120835 □ 120865	 ■ 120635 □ 120665 ■ 130854 □ 130884	 ■ 120833 □ 120863	 ■ 120633 □ 120663	 ■ 120832 □ 120862	 ■ 120632 □ 120662 ■ 130653 □ 130683	 ■ 140831 □ 140861	 ■ 140631 □ 140661	

		d [mm]									
Easy Slide					30 - 31	32 - 33	34 - 35	36 - 37	38 - 39	40 - 41	
Multi Slide		6 - 7	8 - 9	10 - 11	12 - 13	14 - 15	16 - 17	18 - 19	20 - 21	22 - 23	
CL											
		■ 120640 □ 120670	■ 120738 □ 120768	■ 120838 □ 120868	■ 120638 □ 120668	■ 120736 □ 120766	■ 120836 □ 120866	■ 120636 □ 120666	■ 120835 □ 120865	■ 120635 □ 120665	
RL											
							■ 120850 □ 120880	■ 120650 □ 120680	■ 120859 □ 120889	■ 120659 □ 120689	
SL											
							■ 120846 □ 120876	■ 120646 □ 120676	■ 120847 □ 120877	■ 120647 □ 120677	

d [mm]					
42 - 43	44 - 45	46 - 47	48 - 49	50 - 51	52 - 53
24 - 25	26 - 27	28 - 29	30 - 31	32 - 33	34 - 35
■ 120833 □ 120863	■ 120633 □ 120663	■ 120832 □ 120862	■ 120632 □ 120662	■ 140831 □ 140861	■ 140631 □ 140661
■ 140852 □ 140882	■ 120642 □ 120672				
		■ 120849 □ 120879	■ 120649 □ 120679		

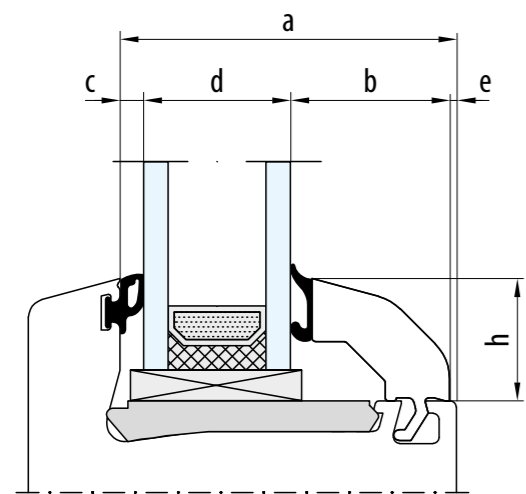

$b = a - c - d - e$

	a [mm]	c [mm]	e [mm]
Ideal 4000	55	4	1
> 140x27	63	4	1
Ideal 5000 Nordline ** Blockprofil Monoblock Ideal 70/Cas HST 70 Smart-Slide	55	4	1
Ideal 7000 Ideal 8000 Energeto 8000 Nordline * HST 85	65	4	1
Easy Slide	32	4	1
Multi Slide	47	4	1

- * Rama
- Dormant
- Frame
- Rahmen
- Telaio
- ** Skrzydło
- Vantail
- Sash
- Flügel
- Anta

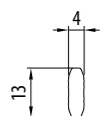

120116

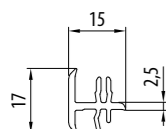

120224

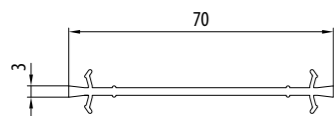

140203

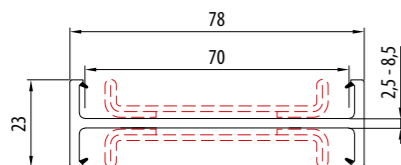

140267

-	0,0	-	lx 0,0	ly 0,0
	1,5	209900	lx 0,1	ly 7,3
	1,5	209900 x 2	lx 0,2	ly 14,6

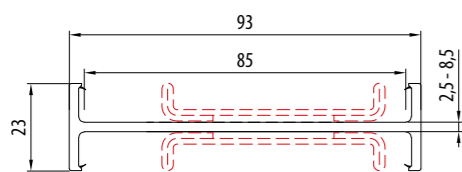

180267

-	0,0	-	lx 0,0	ly 0,0
	1,5	209900	lx 0,1	ly 7,3
	1,5	209900 x 2	lx 0,2	ly 14,6

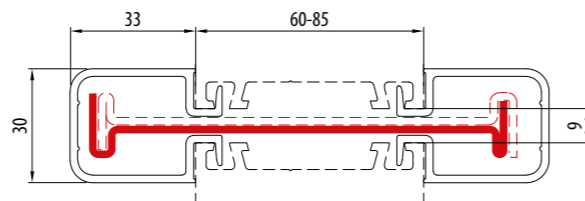

120219

	2,0	229019	lx 0,2	ly 43,3
	2,0	229019 x 2	lx 0,4	ly 86,6

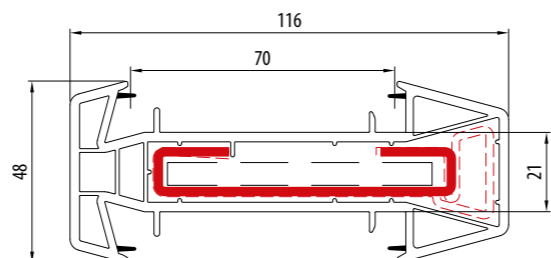

140218

	2,5	229018	lx 0,7	ly 24,8
	2,5+6,0	229018 + 6x70	lx 0,8	ly 41,9
	2,0	289218	lx 1,3	ly 36,9
	2,0+6,0	289218 + 6x70	lx 1,5	ly 54,1

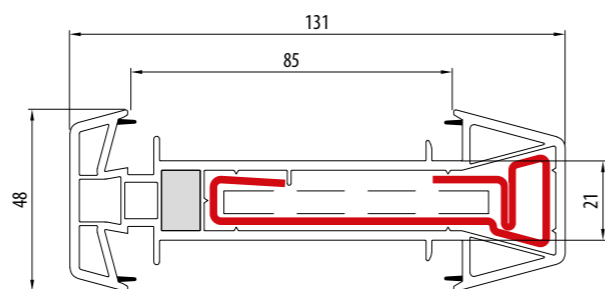

180218

	2,0	289218	lx 1,3	ly 36,9
	2,0+6,0	289218 + 6x70	lx 1,5	ly 54,1

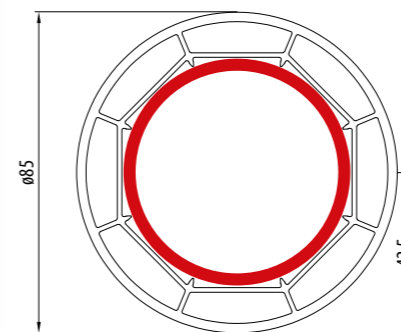

140244

	3,2	249244	lx 23,1	ly 23,1
--	-----	--------	---------	---------

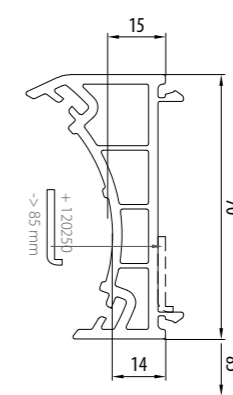

140243

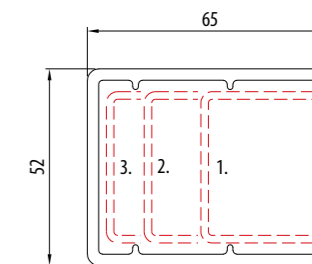

120109

	1,5	229114	lx 4,9	ly 3,9
	2,0	229125	lx 8,5	ly 12,0
	2,0	259926	lx 9,9	ly 18,7

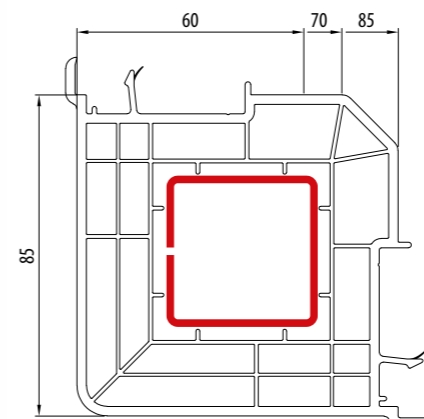

140248

	2,0	229040	lx 7,0	ly 6,9
--	-----	--------	--------	--------

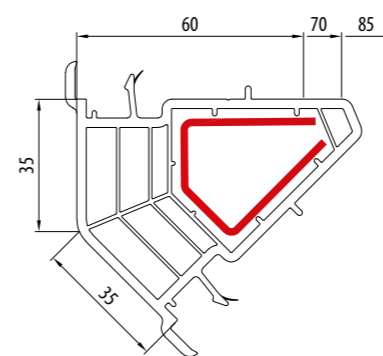

140249

	2,0	249242	lx 2,1	ly 2,8
--	-----	--------	--------	--------

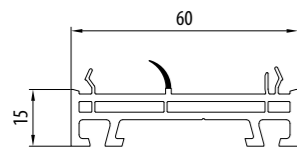

120220

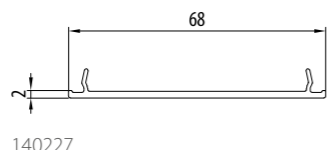

140227

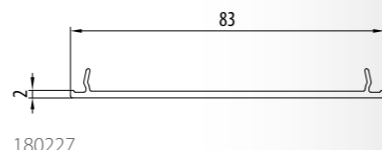

180227

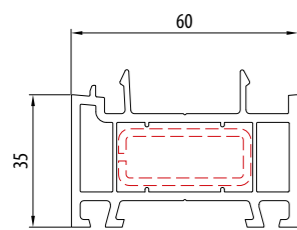

120242

-	0,0	-	lx 0,0	ly 0,0
□	1,5	229110	lx 0,4	ly 1,8

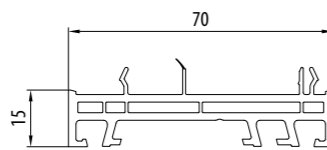

140209

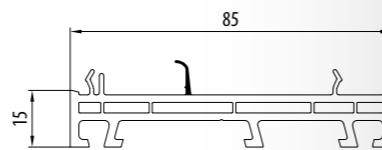

180209

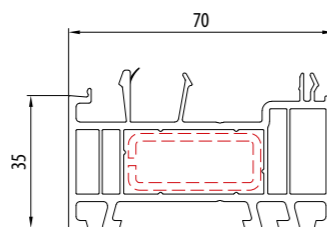

ALU 140205

-	0,0	-	lx 0,0	ly 0,0
□	1,5	229110	lx 0,4	ly 1,8

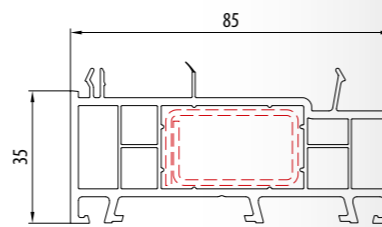

ALU 180201

-	0,0	-	lx 0,0	ly 0,0
□	1,5	229101	lx 1,0	ly 2,8

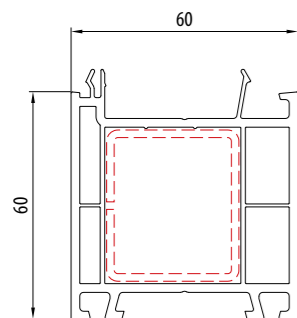

120221

-	0,0	-	lx 0,0	ly 0,0
□	1,5	229114	lx 4,9	ly 3,9

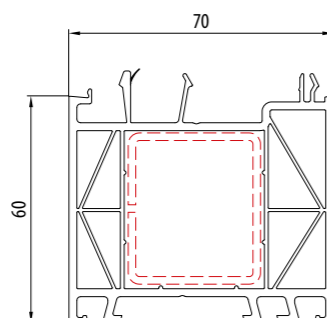

ALU 140207

-	0,0	-	lx 0,0	ly 0,0
□	1,5	229114	lx 4,9	ly 3,9

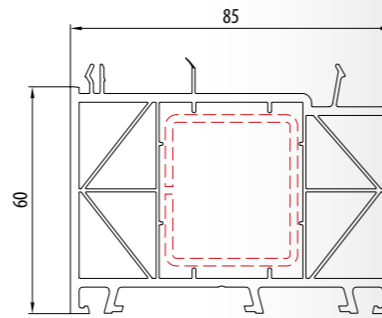

ALU 180203

-	0,0	-	lx 0,0	ly 0,0
□	1,5	229114	lx 4,9	ly 3,9

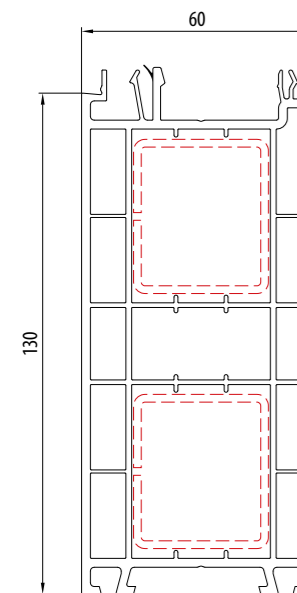

120223

-	0,0	-	lx 0,0	ly 0,0
□	1,5	229114 x 2	lx 9,8	ly 7,8

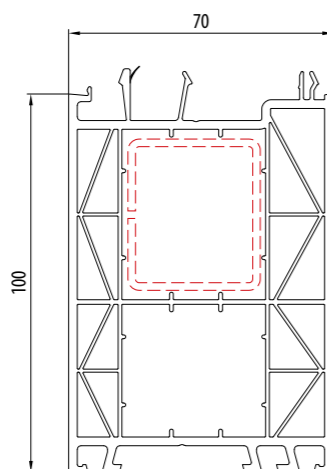

ALU 140208

-	0,0	-	lx 0,0	ly 0,0
□	1,5	229114	lx 4,9	ly 3,9

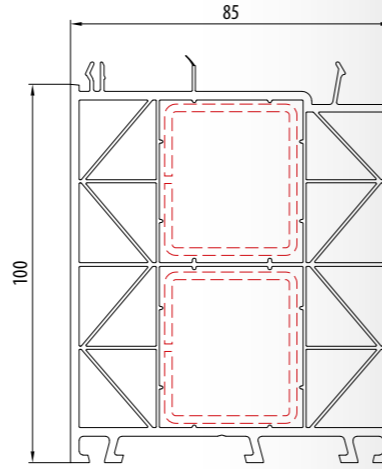

ALU 180204

-	0,0	-	lx 0,0	ly 0,0
□	1,5	229114 x 2	lx 9,8	ly 7,8

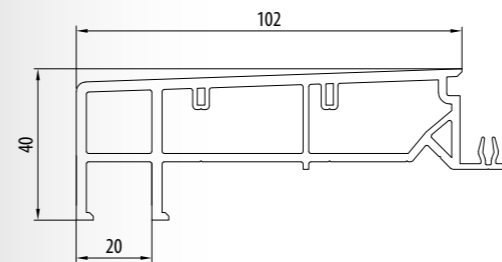

120196

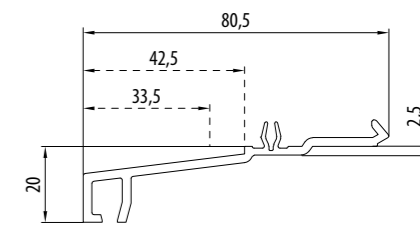

140229

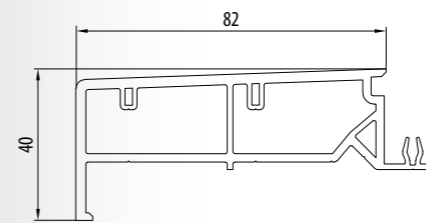

120270

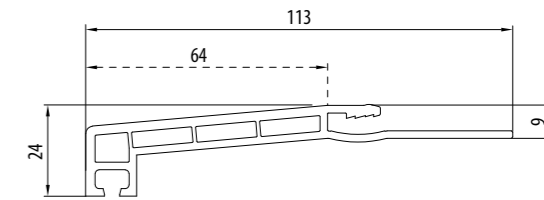

140219

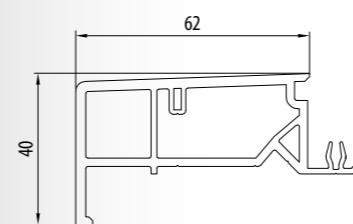

120195

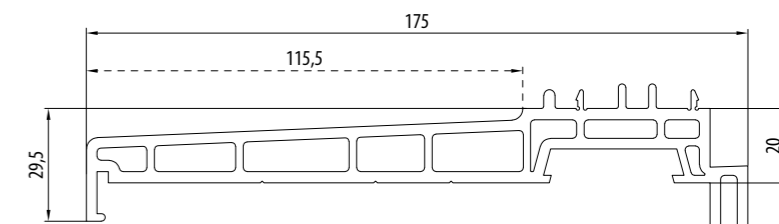

120190

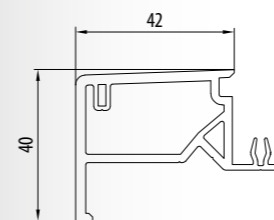

120194

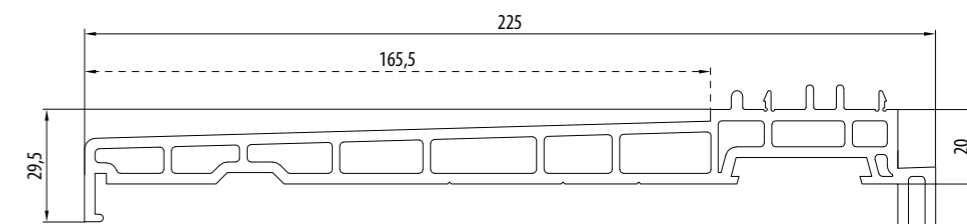

120192

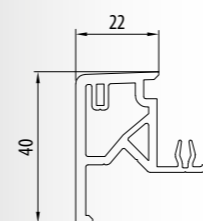

120193

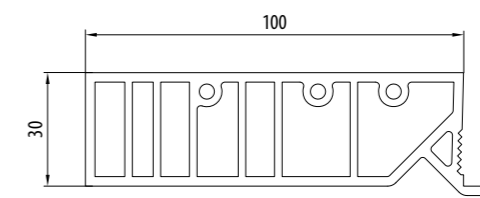

120112

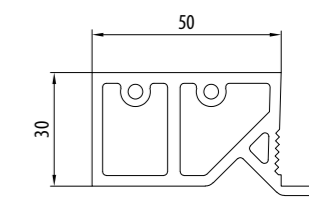

120113

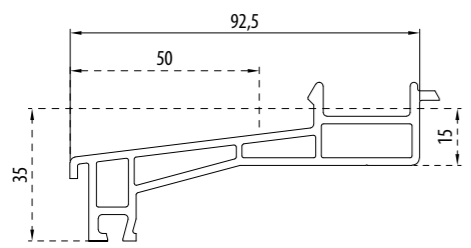

120246

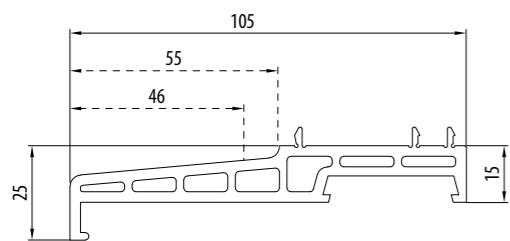

120248

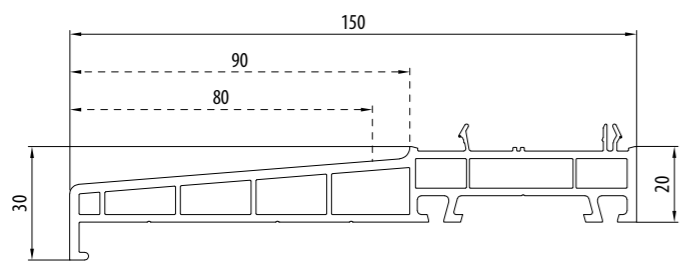

120249

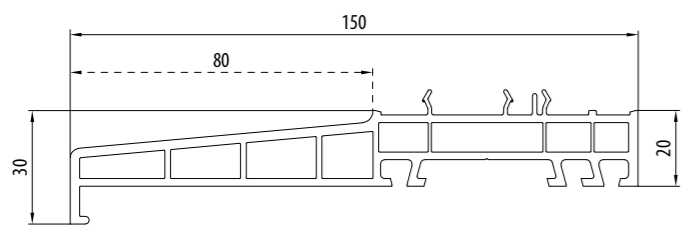

140238

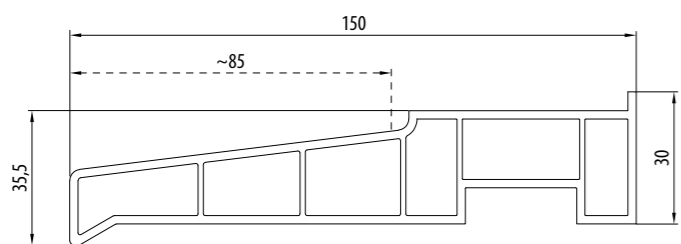

100220

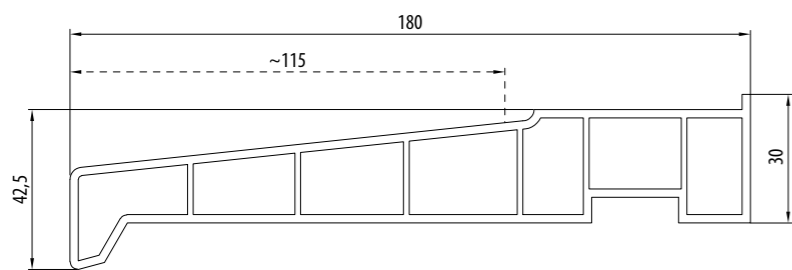

120108

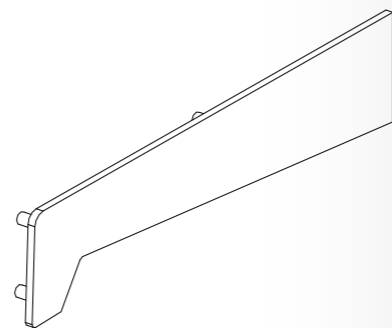

600020

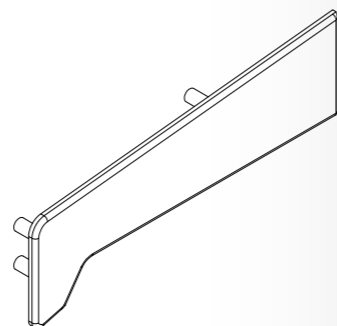

600220

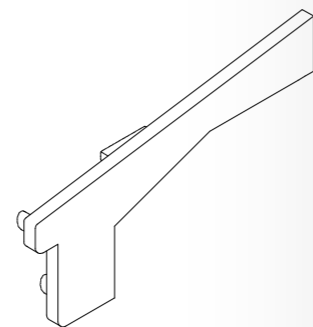

650921

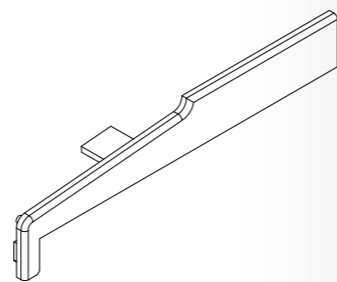

620249

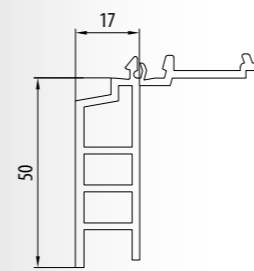

120210

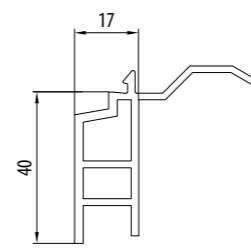

120209

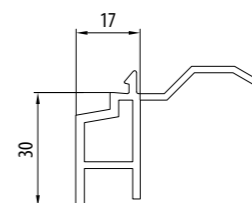

120208

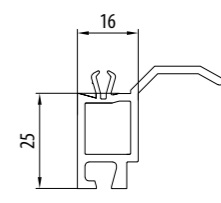

120206

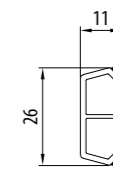

160376

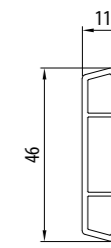

160378

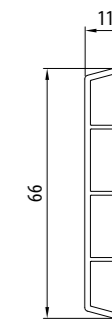

160479

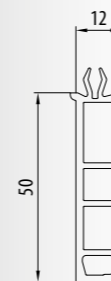

120102

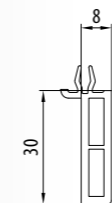

120237

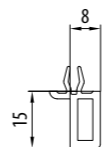

120236

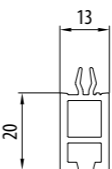

120106

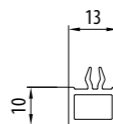

140277

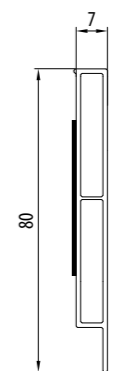

650780

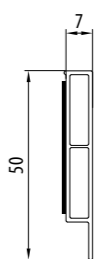

640756

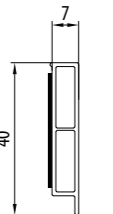

640746

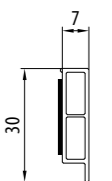

640736

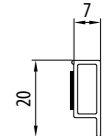

640726

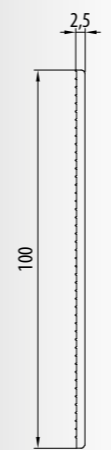

65025100

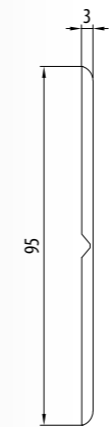

6465050

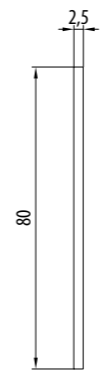

65025080

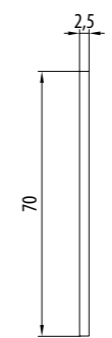

65025070

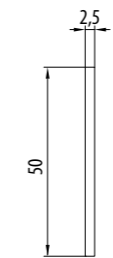

65025050

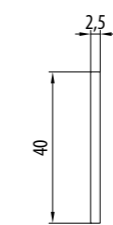

65025040

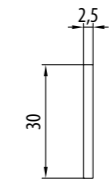

65025030

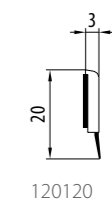

120120

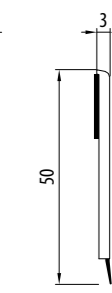

120283

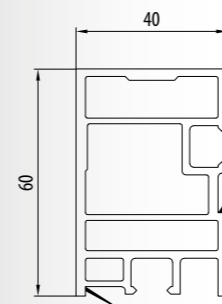

140276

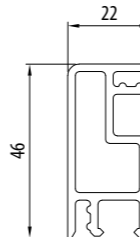

140275

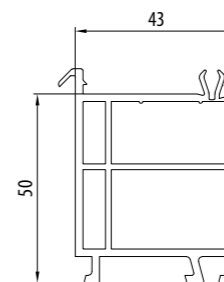

120238

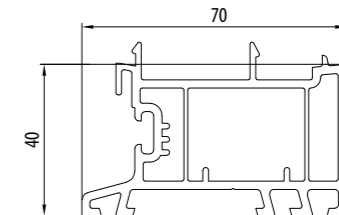

140200

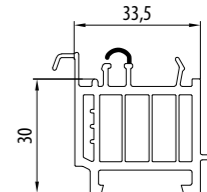

144247

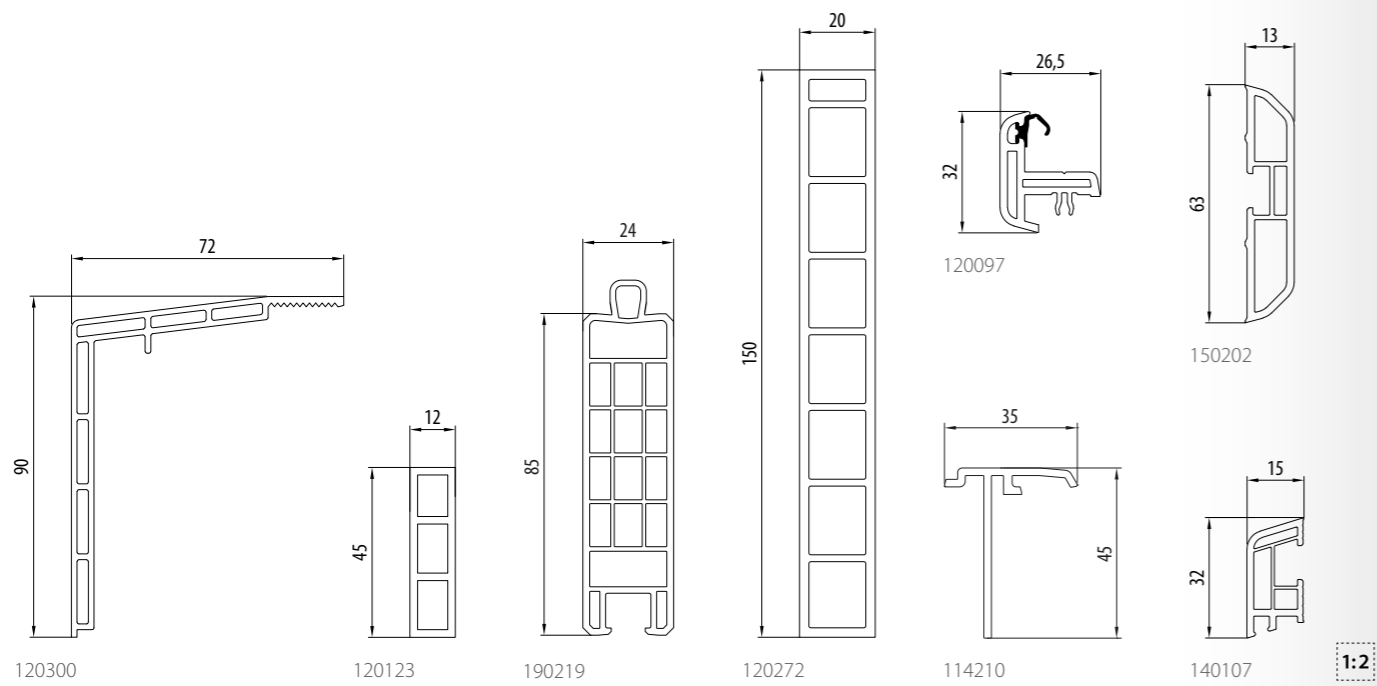
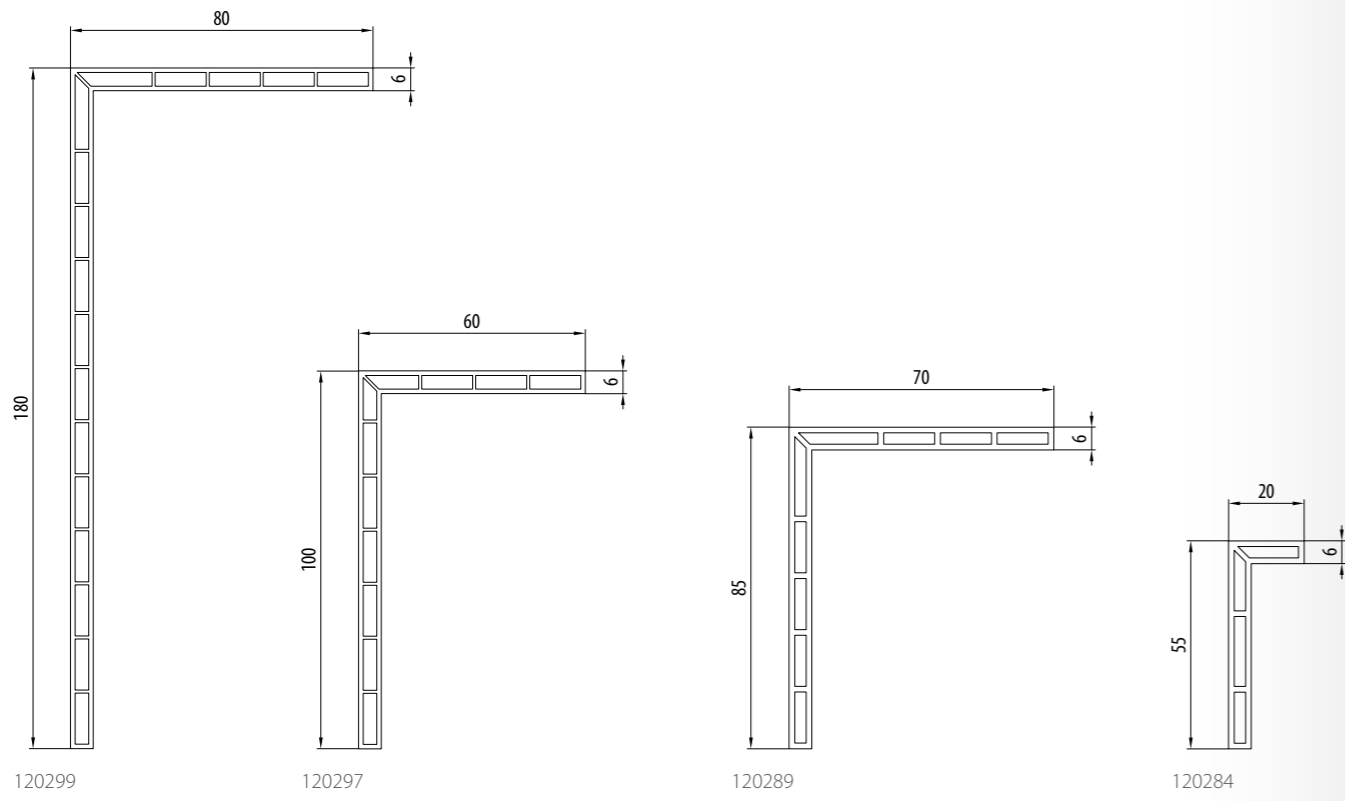
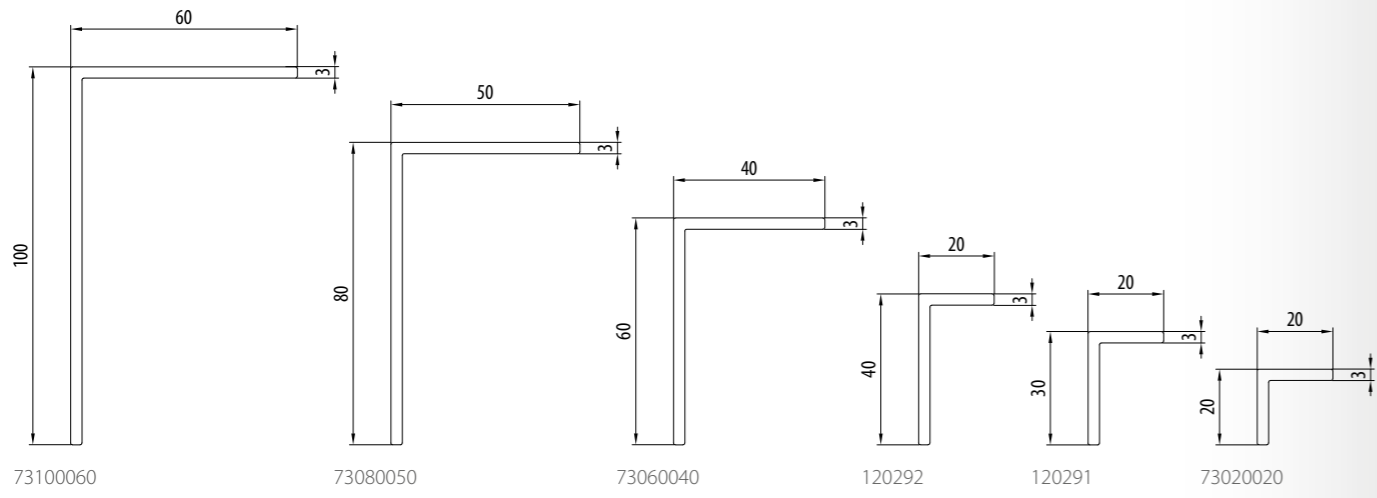

1:2

IDEAL





IDEAL

SALAMANDER[®]

WINDOW & DOOR SYSTEMS

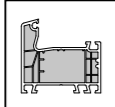
STREAMLINE 76

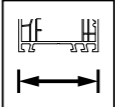
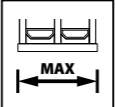

- 
5
- 
2
- 
76
- 
49
- 
V-PERFECT TECHNOLOGY
- 
ALU



STREAMLINE 76

BLUEEVOLUTION 82

BLUEEVOLUTION 92

STREAMLINE 76

BLUEEVOLUTION 82

BLUEEVOLUTION 92

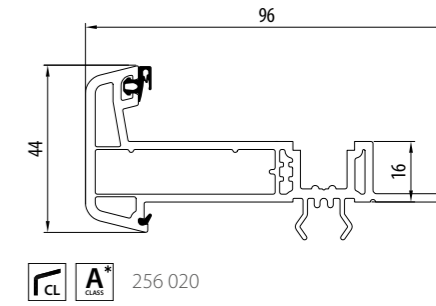
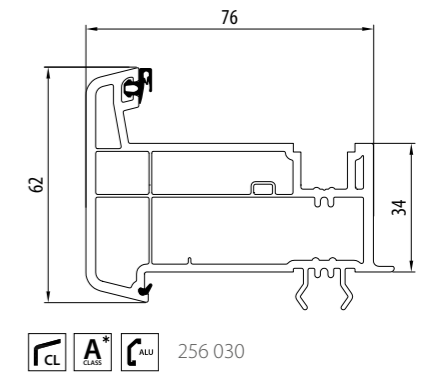
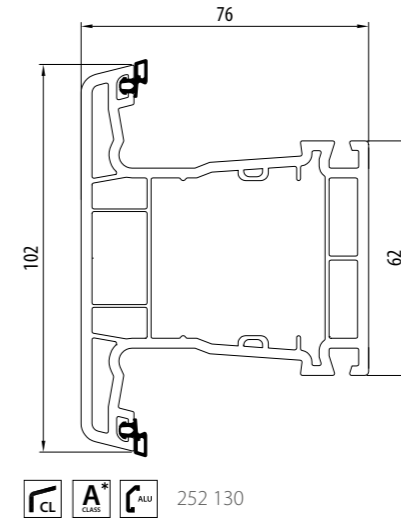
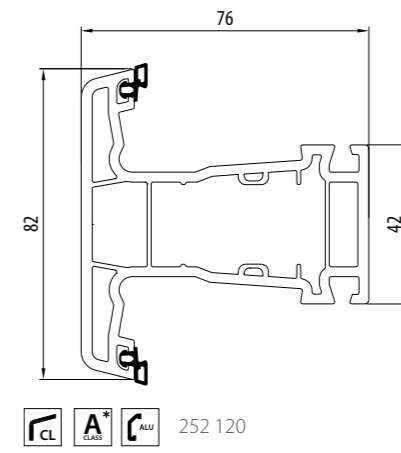
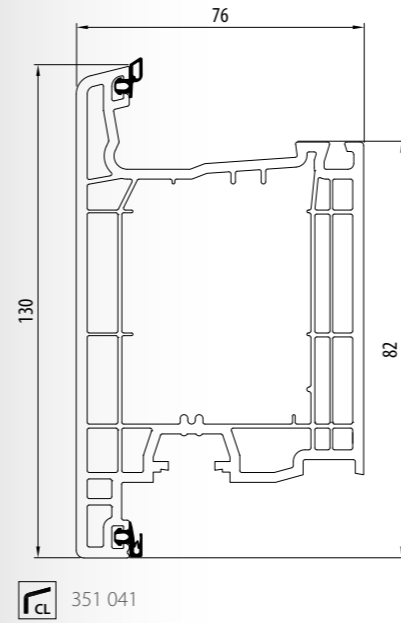
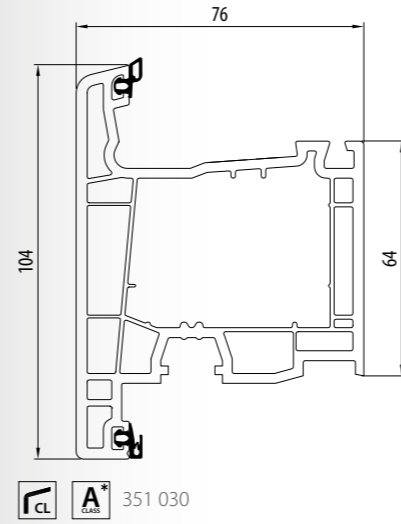
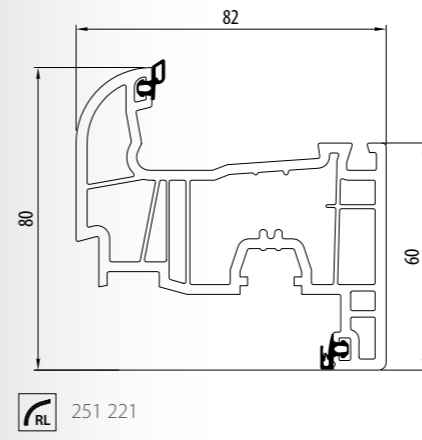
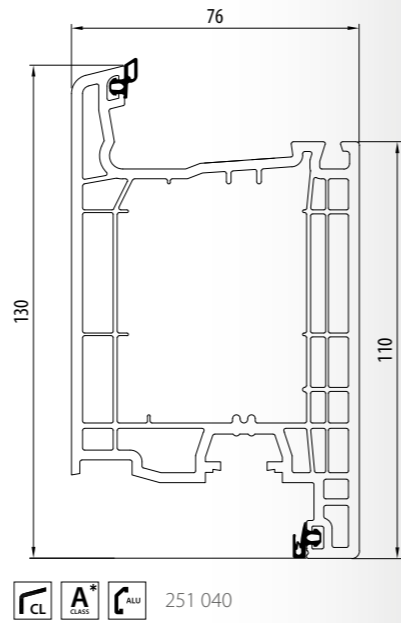
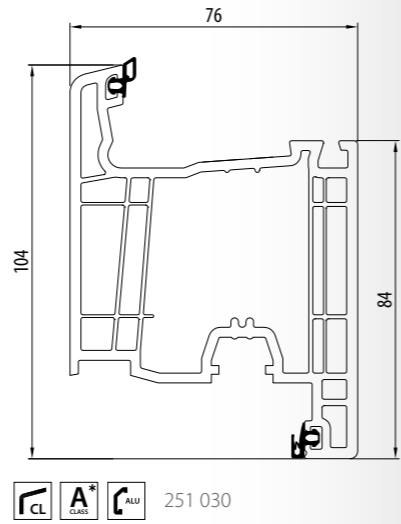
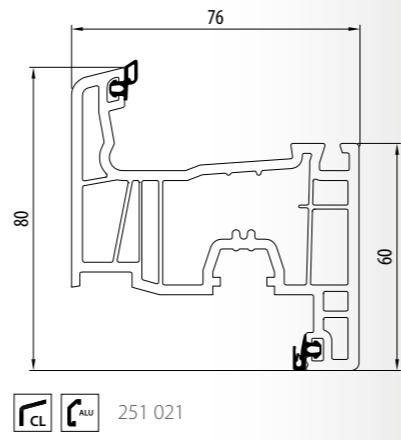
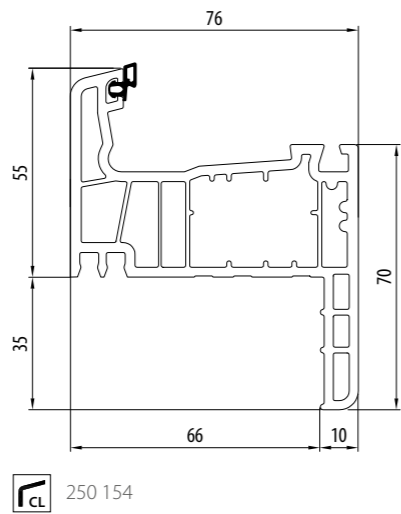
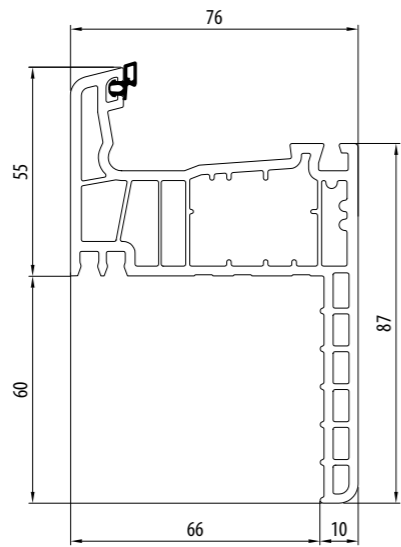
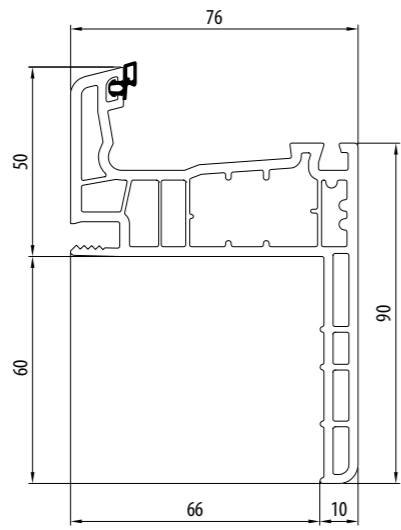
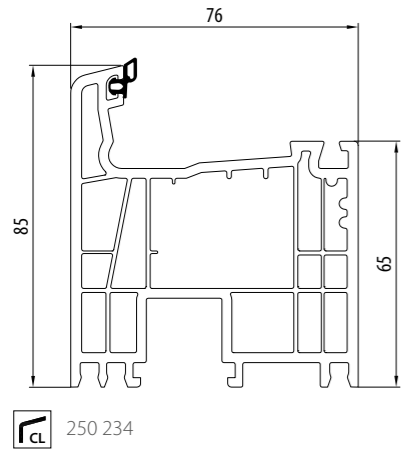
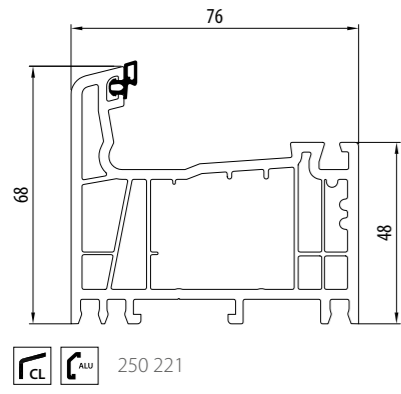
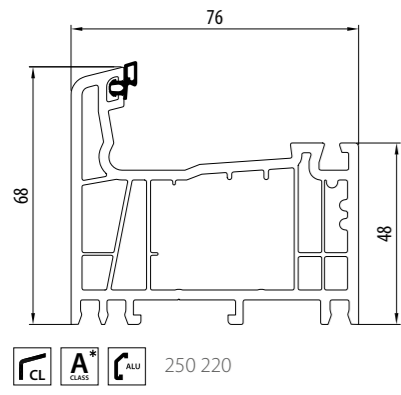

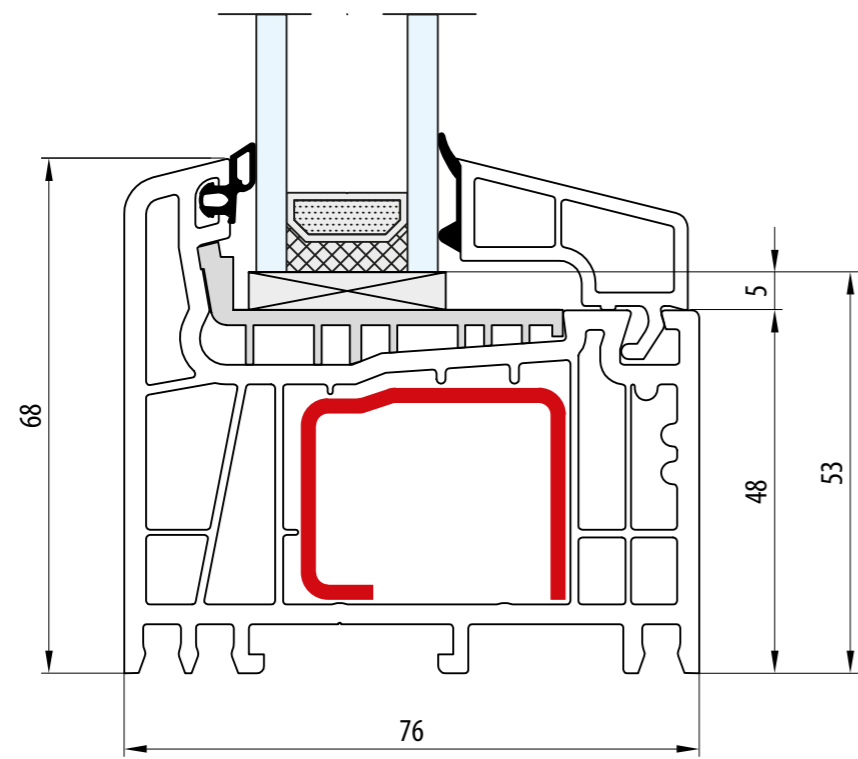

- Rama: 68 mm
- Dormant: 68 mm
- Frame: 68 mm
- Rahmen: 68 mm
- Telaio: 68 mm

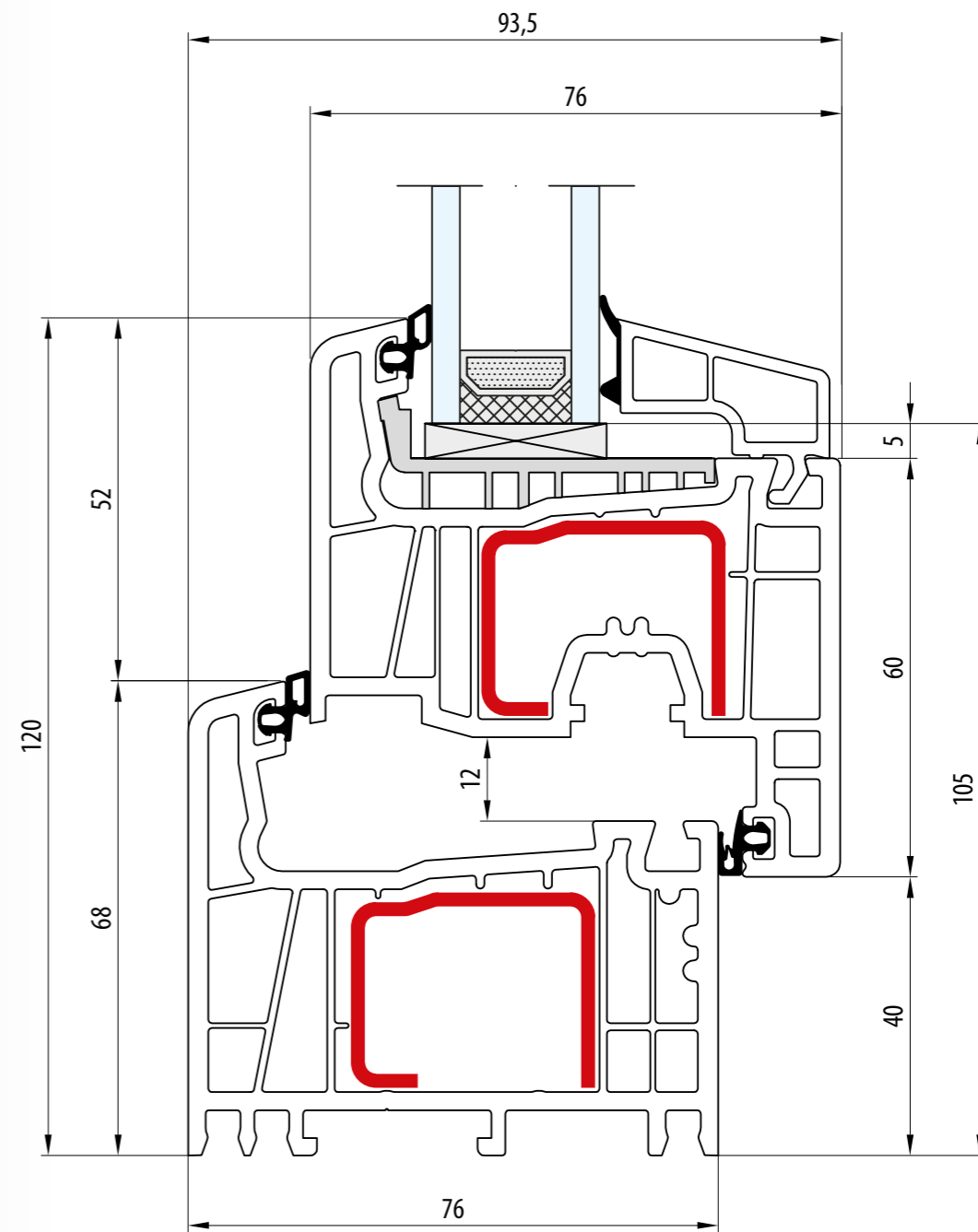
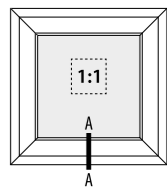
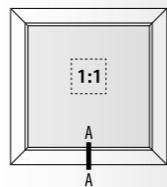

- Rama: 68 mm · Skrzydło: 80 mm
- Dormant: 68 mm · Vantail: 80 mm
- Frame: 68 mm · Sash: 80 mm
- Rahmen: 68 mm · Flügel: 80 mm
- Telaio: 68 mm · Anta: 80 mm

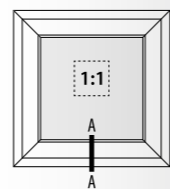
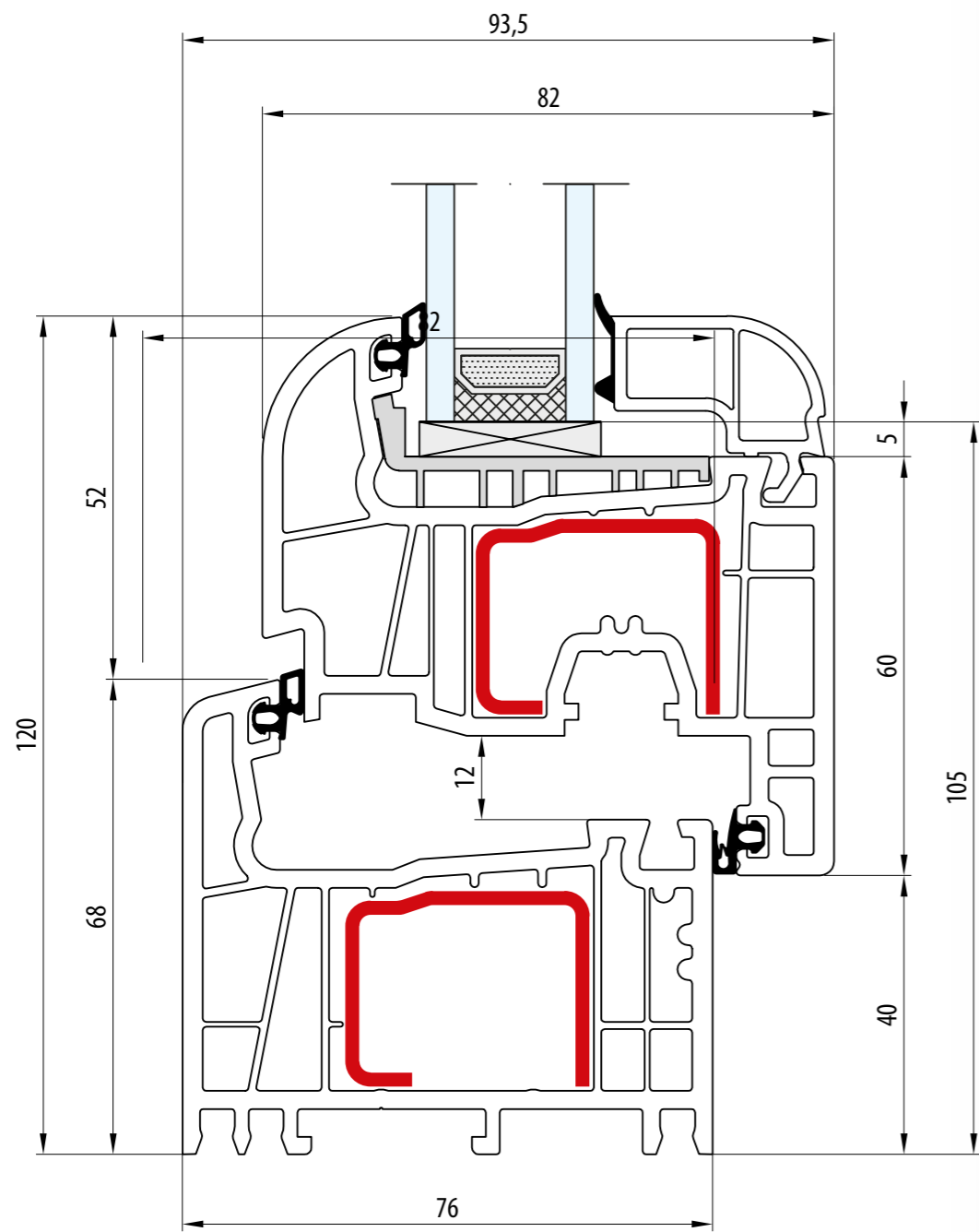

- Rama: 68 mm · Skrzydło: 80 mm
- Dormant: 68 mm · Vantail: 80 mm
- Frame: 68 mm · Sash: 80 mm
- Rahmen: 68 mm · Flügel: 80 mm
- Telaio: 68 mm · Anta: 80 mm

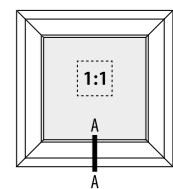
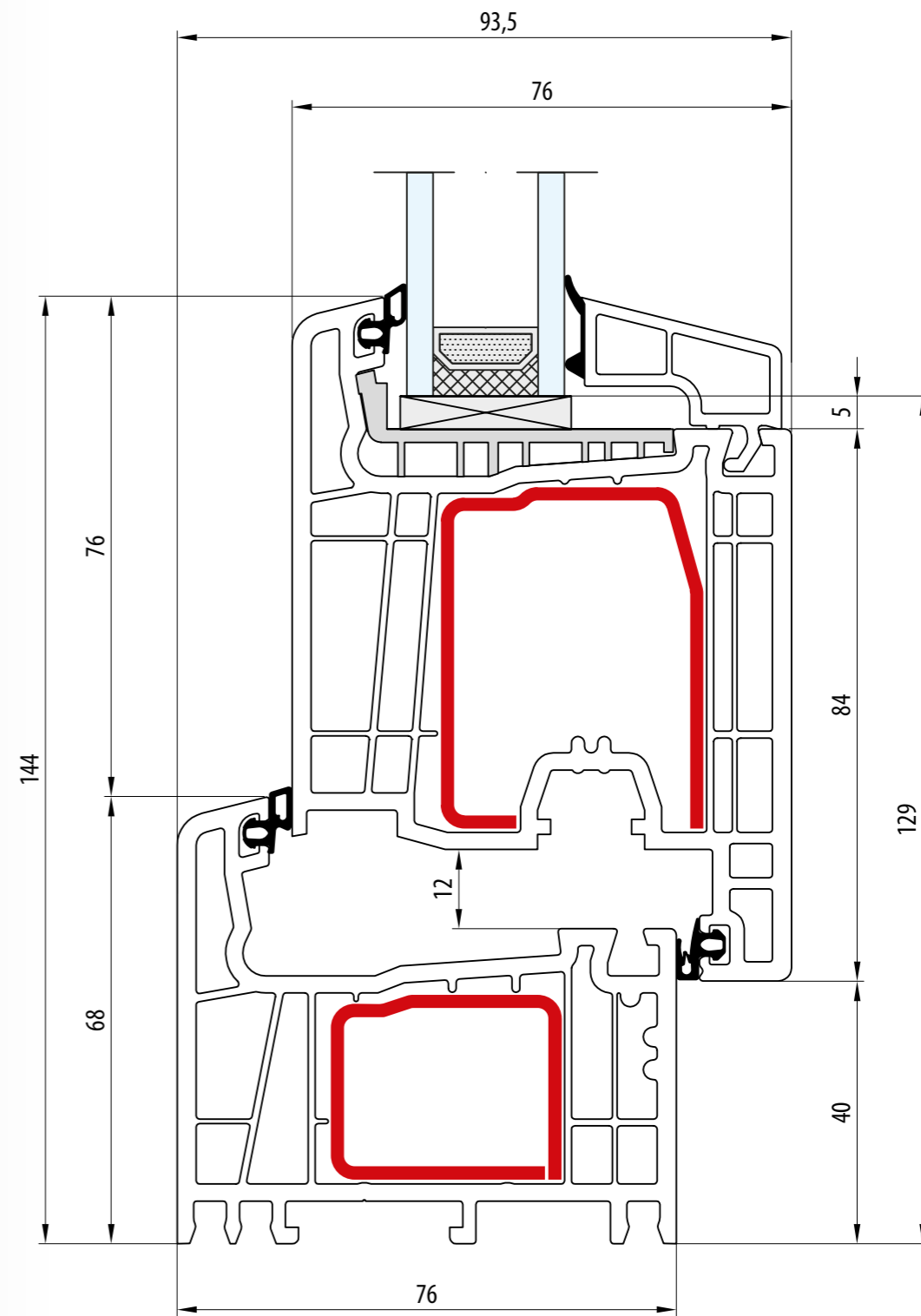

- Rama: 68 mm · Skrzydło: 104 mm
- Dormant: 68 mm · Vantail: 104 mm
- Frame: 68 mm · Sash: 104 mm
- Rahmen: 68 mm · Flügel: 104 mm
- Telaio: 68 mm · Anta: 104 mm

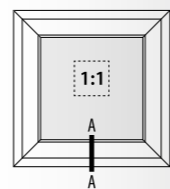
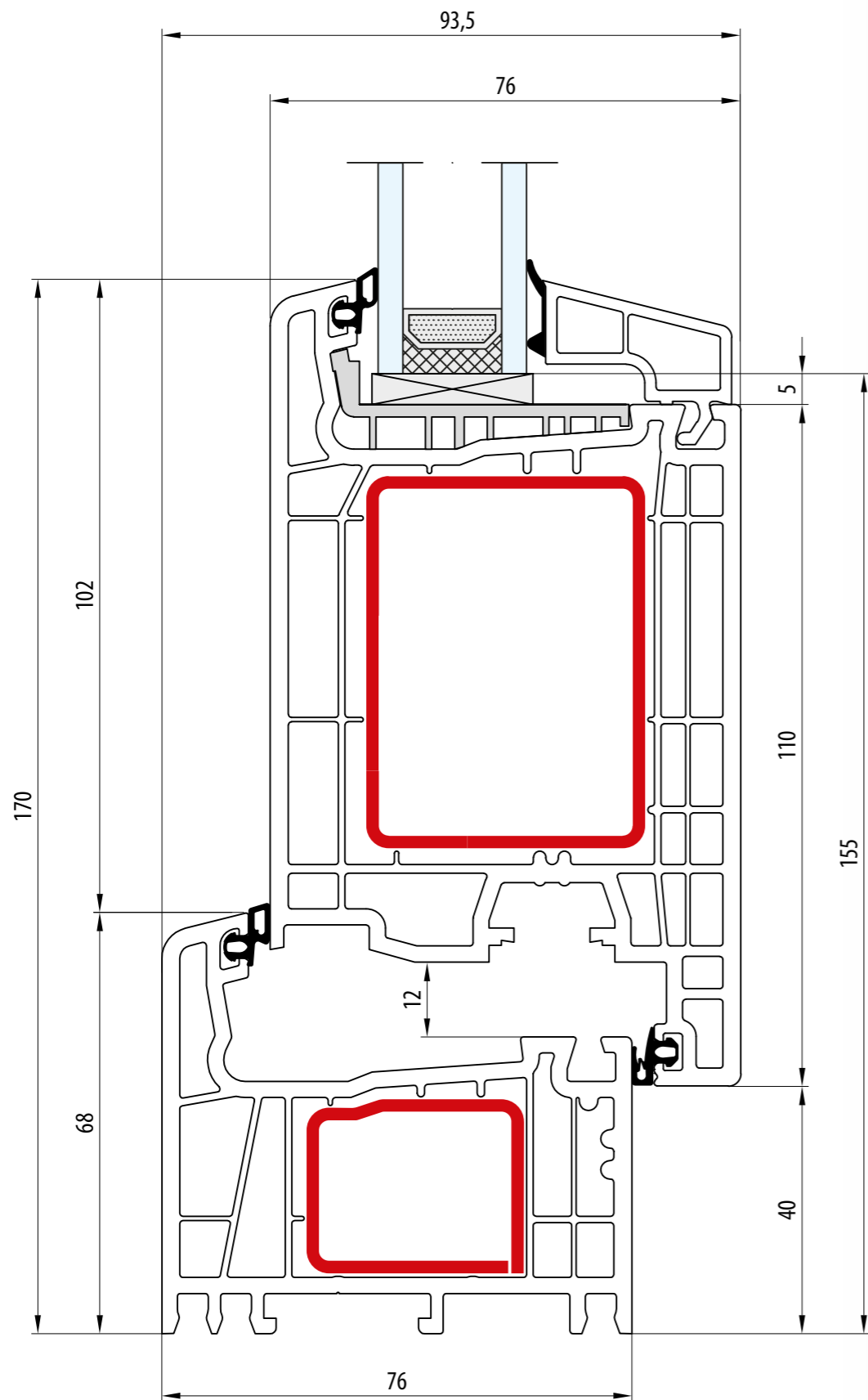

- Rama: 68 mm · Skrzydło: 130 mm
- Dormant: 68 mm · Vantail: 130 mm
- Frame: 68 mm · Sash: 130 mm
- Rahmen: 68 mm · Flügel: 130 mm
- Telaio: 68 mm · Anta: 130 mm

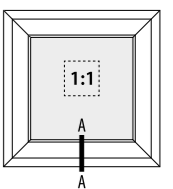
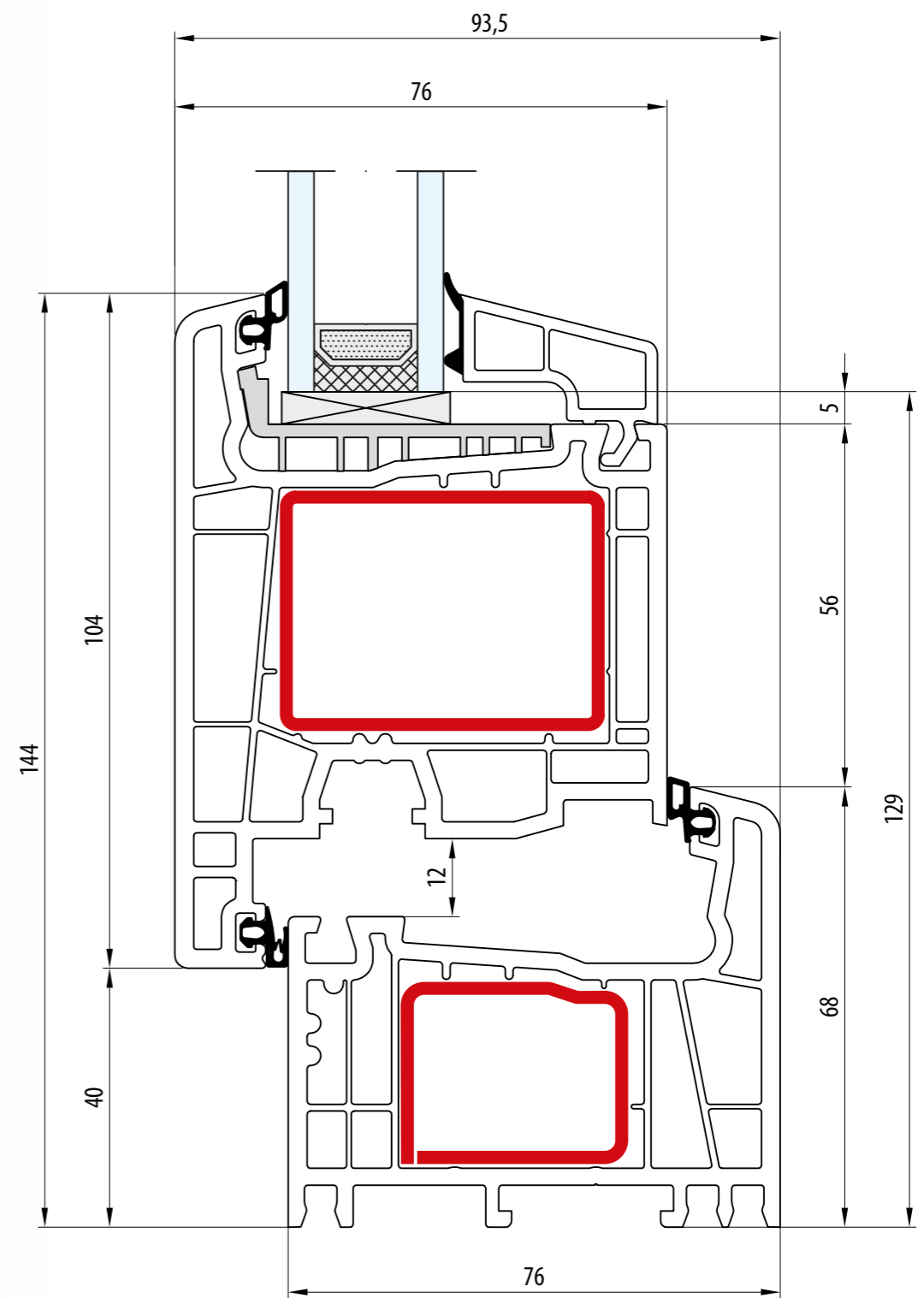

- Rama: 68 mm · Skrzydło: 104 mm
- Dormant: 68 mm · Vantail: 104 mm
- Frame: 68 mm · Sash: 104 mm
- Rahmen: 68 mm · Flügel: 104 mm
- Telaio: 68 mm · Anta: 104 mm

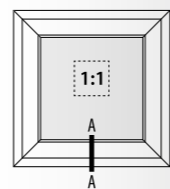
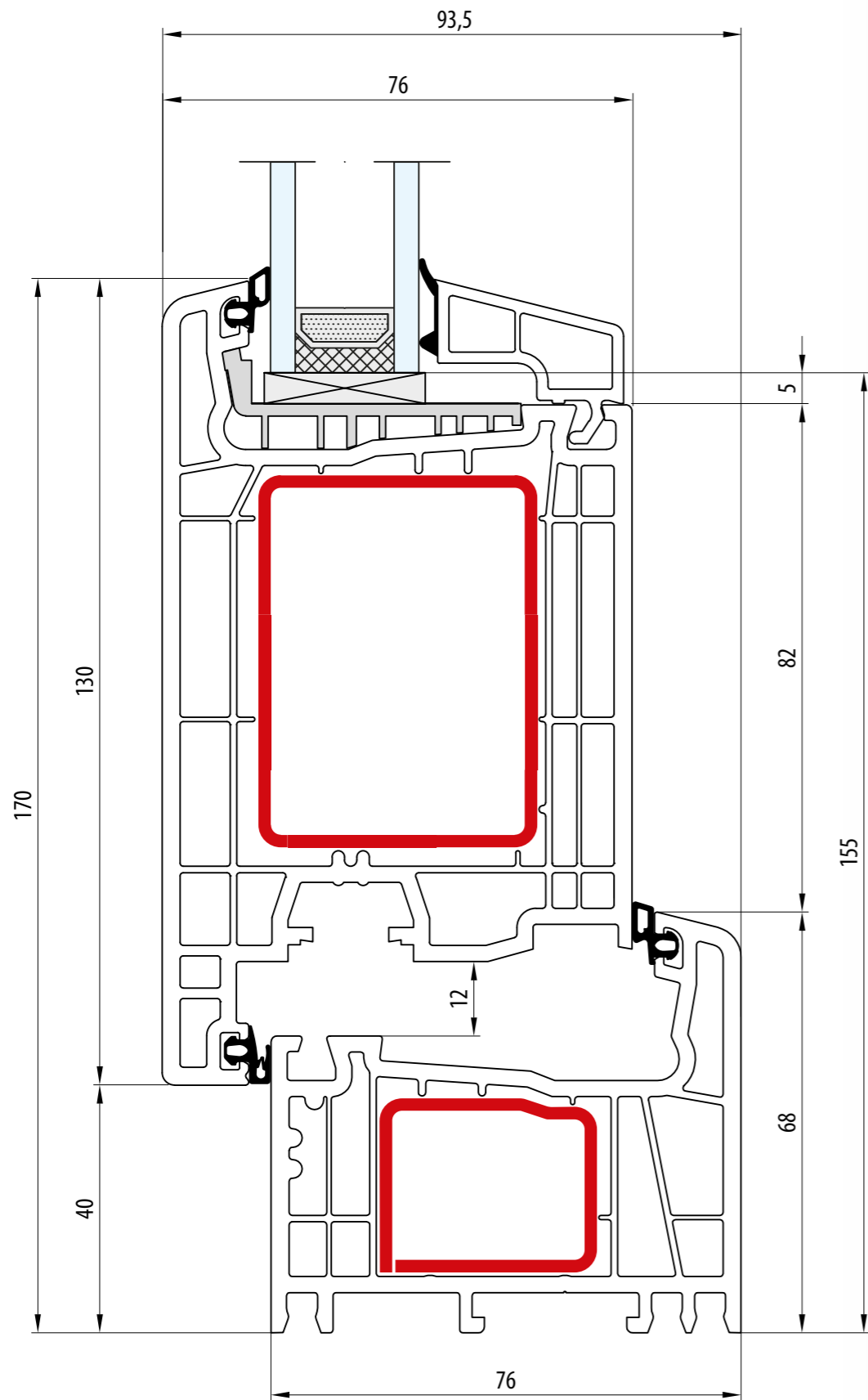

- Rama: 68 mm · Skrzydło: 130 mm
- Dormant: 68 mm · Vantail: 130 mm
- Frame: 68 mm · Sash: 130 mm
- Rahmen: 68 mm · Flügel: 130 mm
- Telaio: 68 mm · Anta: 130 mm

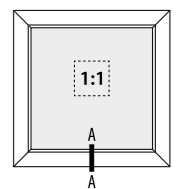
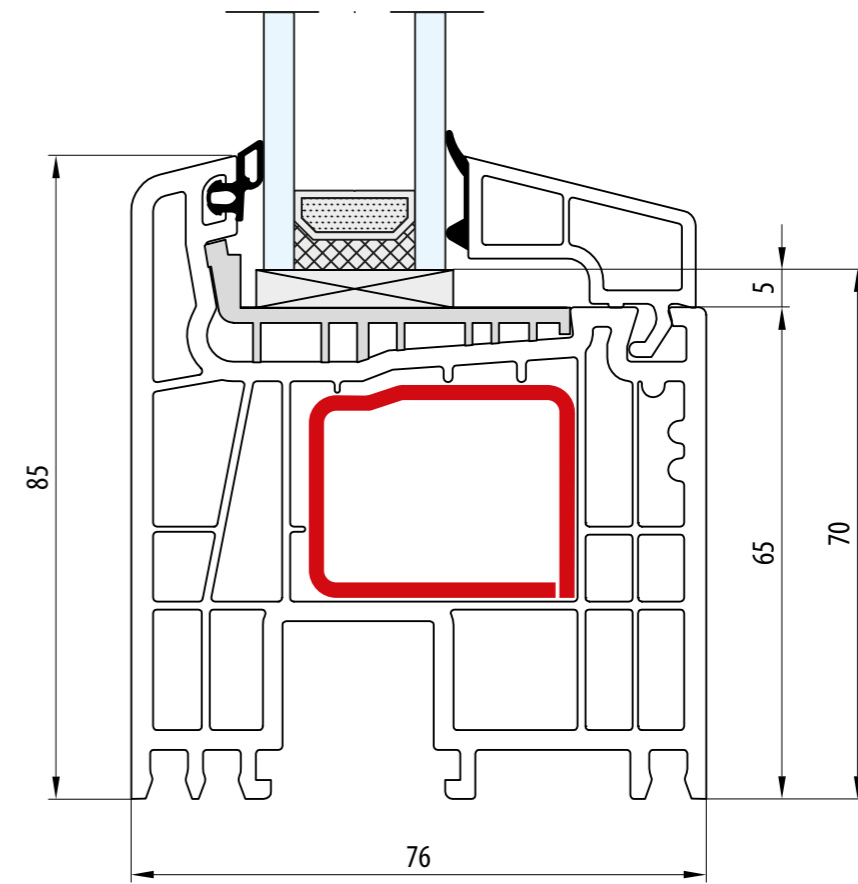

- Rama: 85 mm
- Dormant: 85 mm
- Frame: 85 mm
- Rahmen: 85 mm
- Telaio: 85 mm

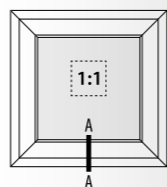
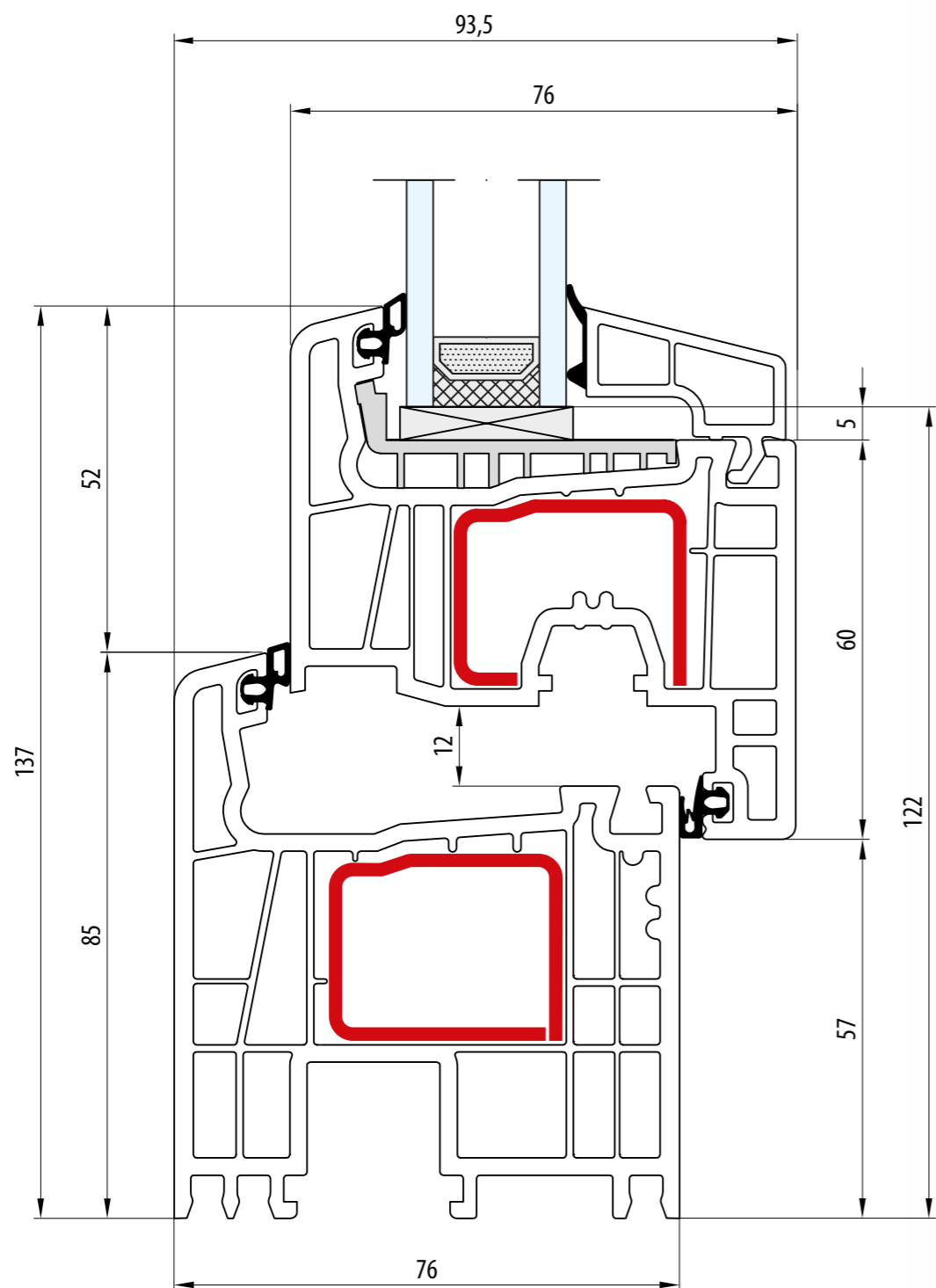

- Rama: 85 mm · Skrzydło: 80 mm
- Dormant: 85 mm · Vantail: 80 mm
- Frame: 85 mm · Sash: 80 mm
- Rahmen: 85 mm · Flügel: 80 mm
- Telaio: 85 mm · Anta: 80 mm

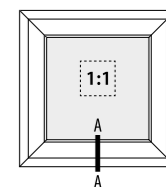
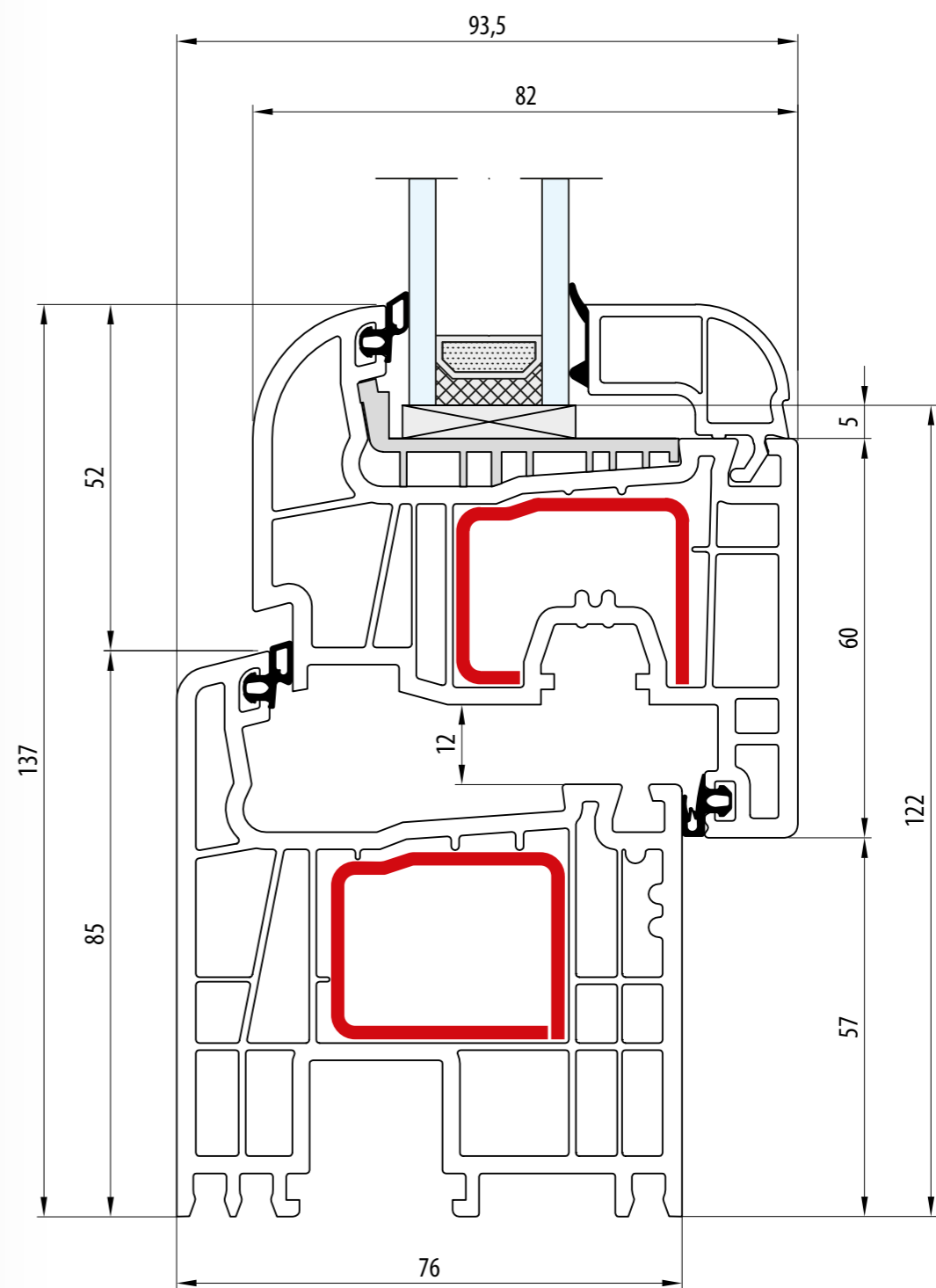

- Rama: 85 mm · Skrzydło: 80 mm
- Dormant: 85 mm · Vantail: 80 mm
- Frame: 85 mm · Sash: 80 mm
- Rahmen: 85 mm · Flügel: 80 mm
- Telaio: 85 mm · Anta: 80 mm

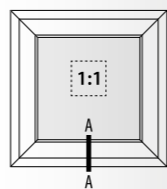
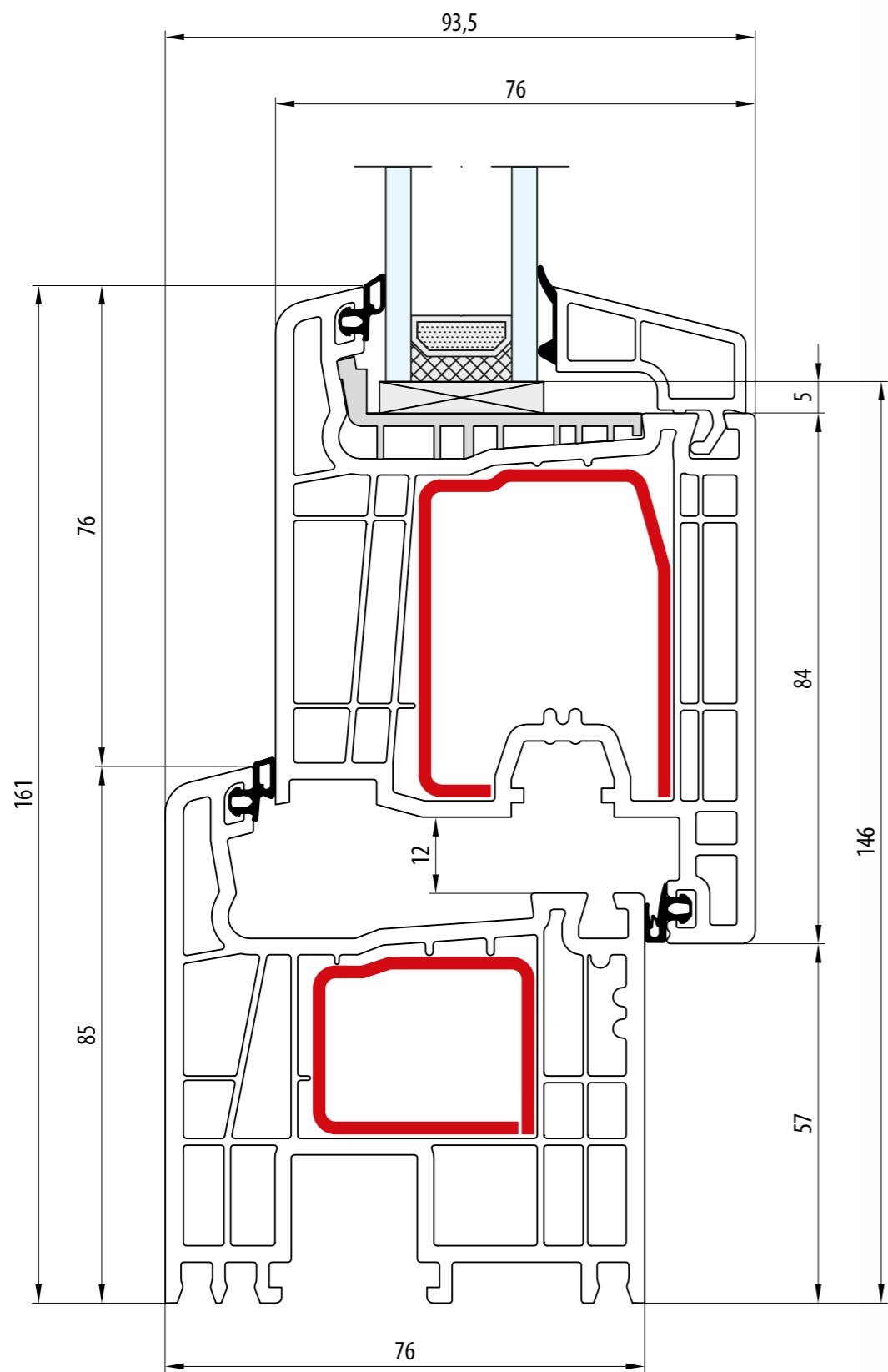

- Rama: 85 mm · Skrzydło: 104 mm
- Dormant: 85 mm · Vantail: 104 mm
- Frame: 85 mm · Sash: 104 mm
- Rahmen: 85 mm · Flügel: 104 mm
- Telaio: 85 mm · Anta: 104 mm

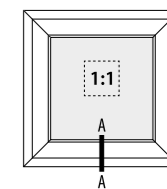
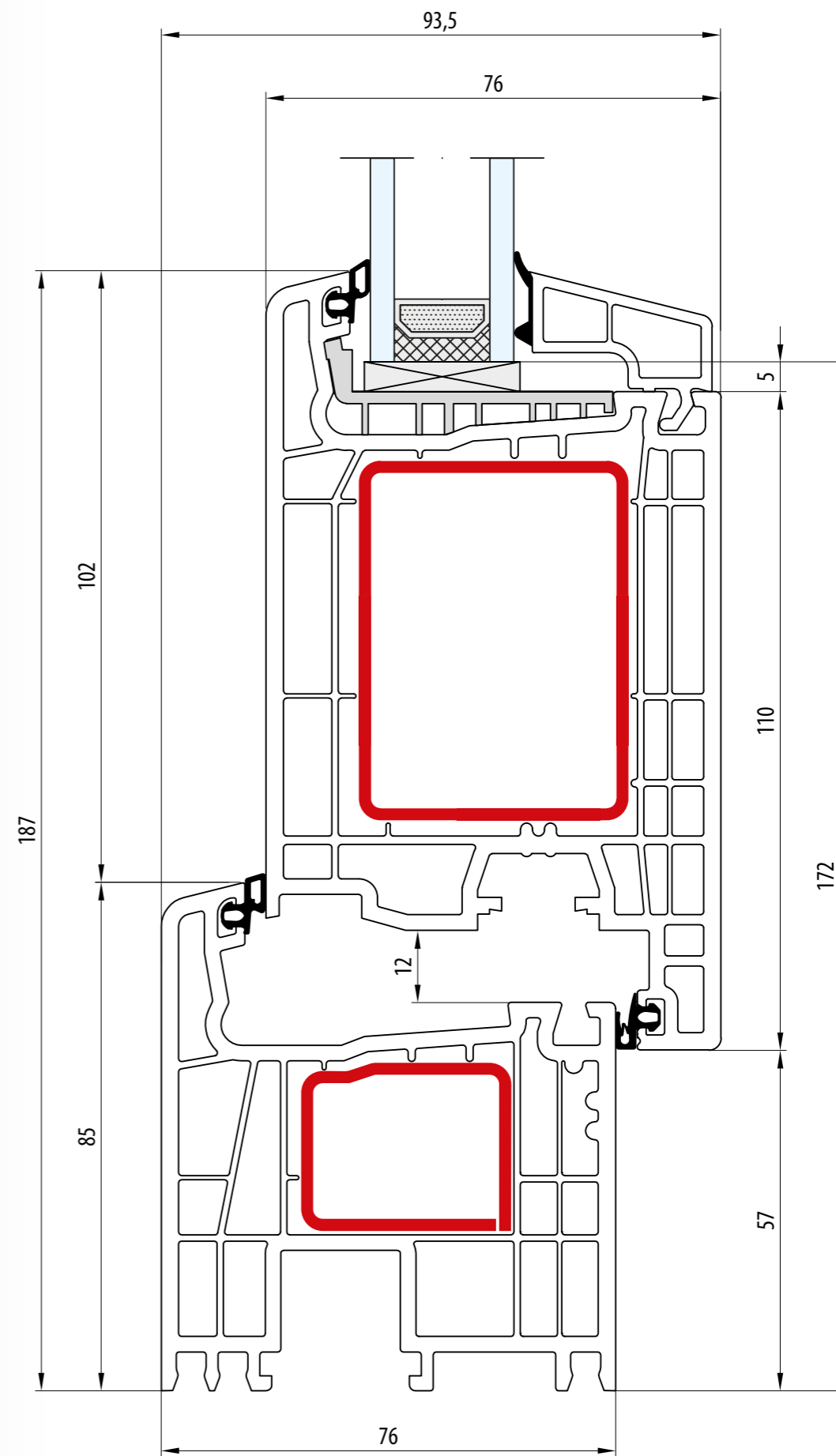

- Rama: 85 mm · Skrzydło: 130 mm
- Dormant: 85 mm · Vantail: 130 mm
- Frame: 85 mm · Sash: 130 mm
- Rahmen: 85 mm · Flügel: 130 mm
- Telaio: 85 mm · Anta: 130 mm

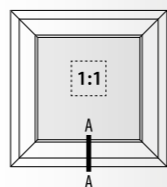
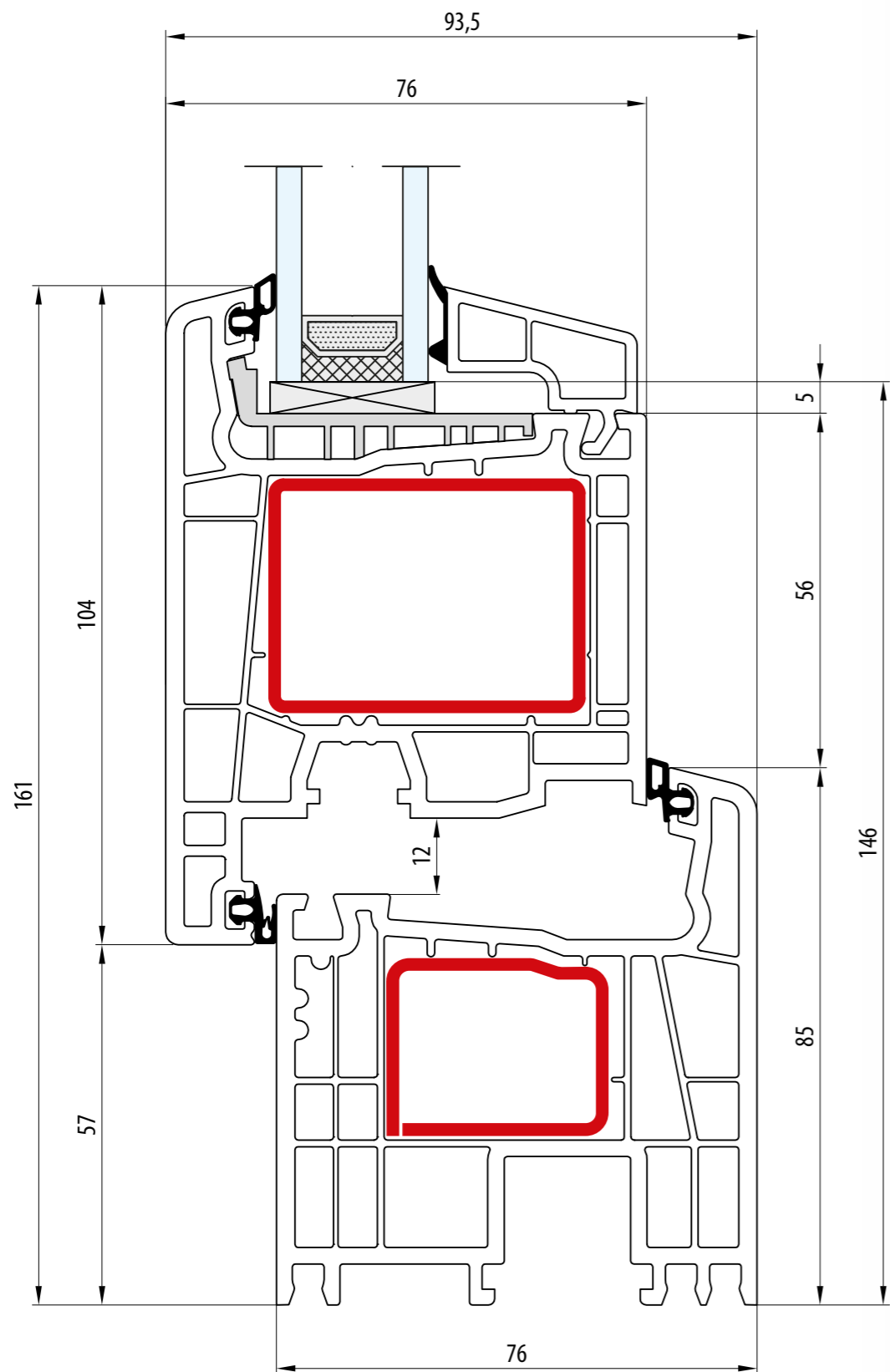

- Rama: 85 mm · Skrzydło: 104 mm
- Dormant: 85 mm · Vantail: 104 mm
- Frame: 85 mm · Sash: 104 mm
- Rahmen: 85 mm · Flügel: 104 mm
- Telaio: 85 mm · Anta: 104 mm

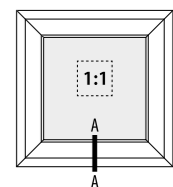
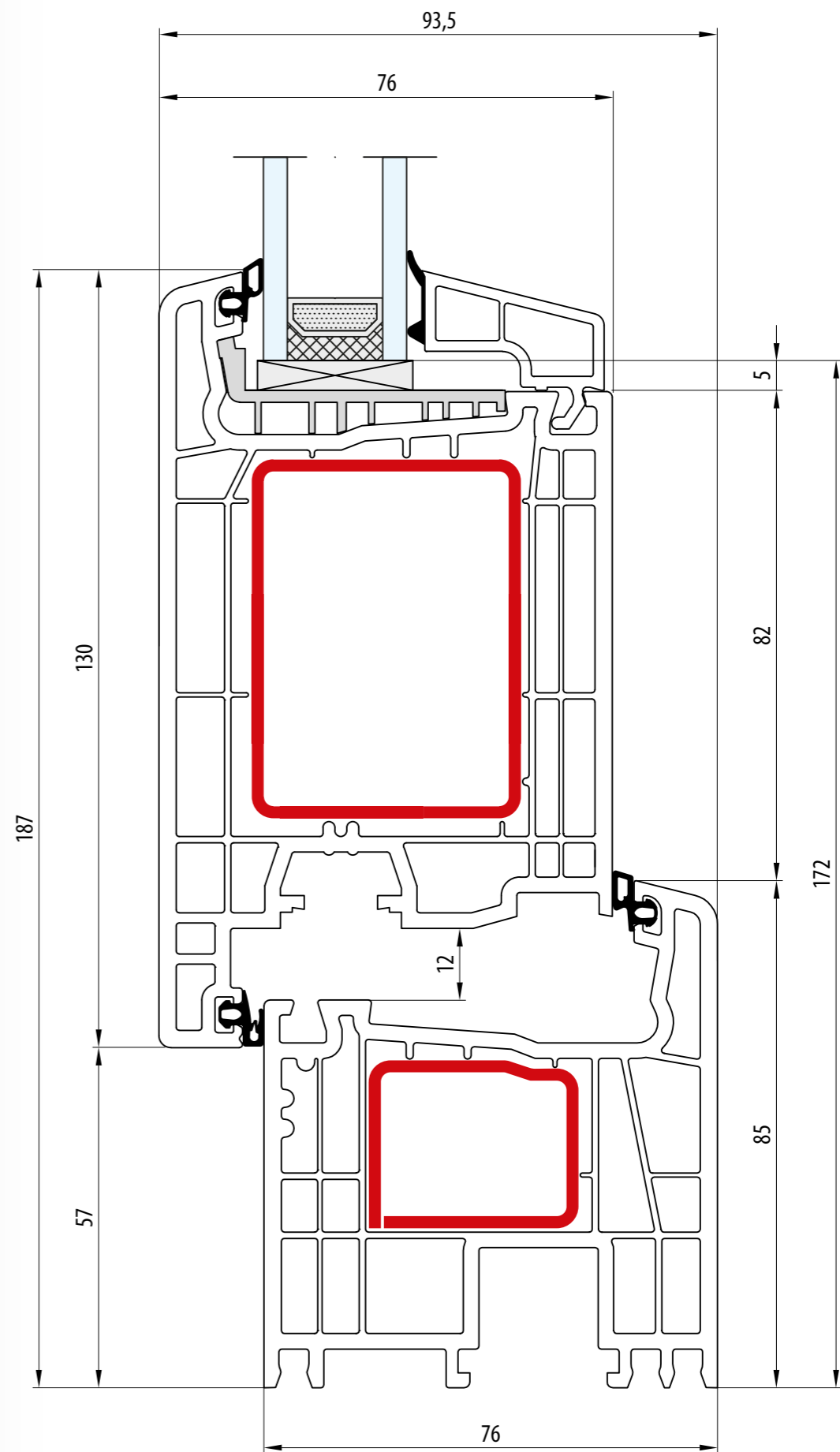

- Rama: 85 mm · Skrzydło: 130 mm
- Dormant: 85 mm · Vantail: 130 mm
- Frame: 85 mm · Sash: 130 mm
- Rahmen: 85 mm · Flügel: 130 mm
- Telaio: 85 mm · Anta: 130 mm

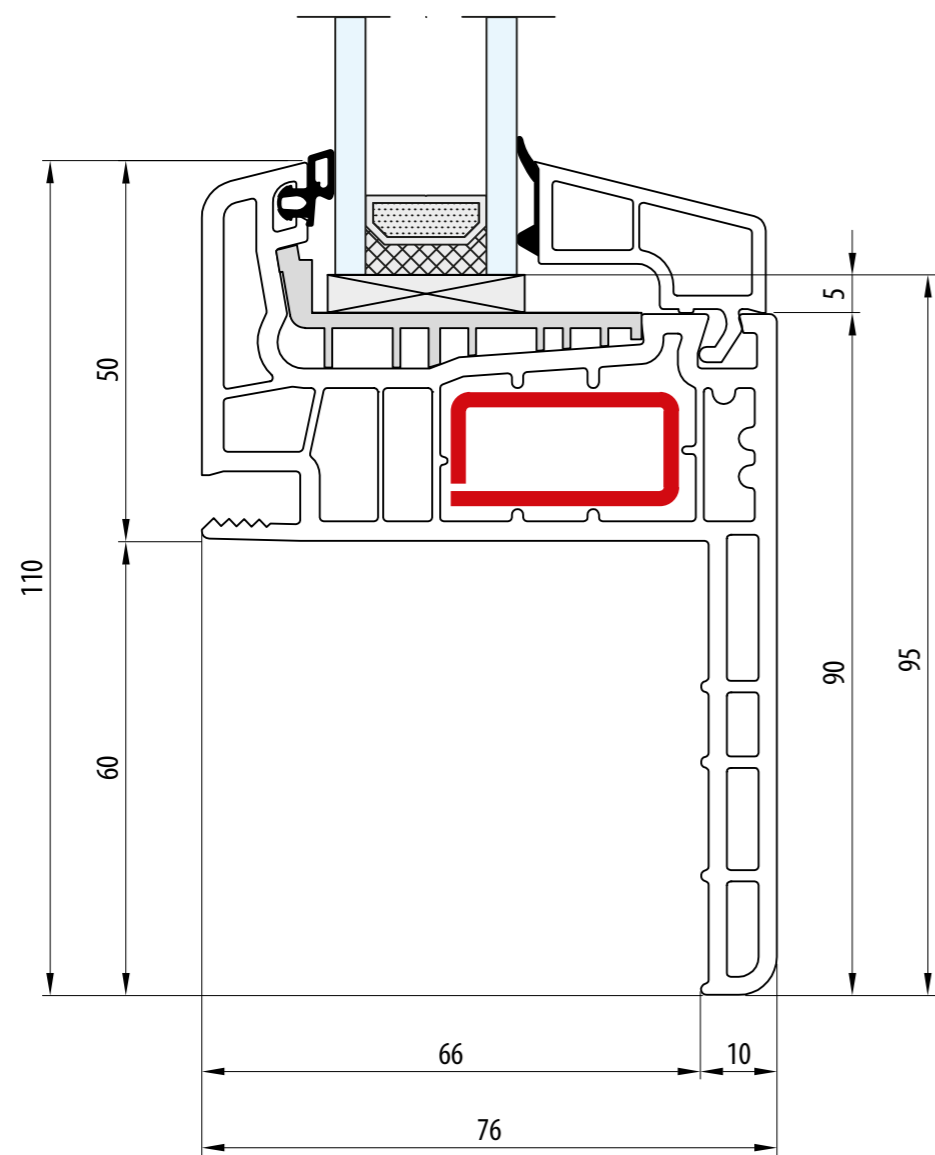

- RENOWACJA - Pletwa: 60 mm · Rama: 50 mm
- RÉNOVATION - Lip: 60 mm · Dormant: 50 mm
- RENOVATION - Strip: 60 mm · Frame: 50 mm
- RENOVIERUNG - Flosse: 60 mm · Rahmen: 50 mm
- RINNOVAZIONE - Aletta da: 60 mm · Telaio: 50 mm

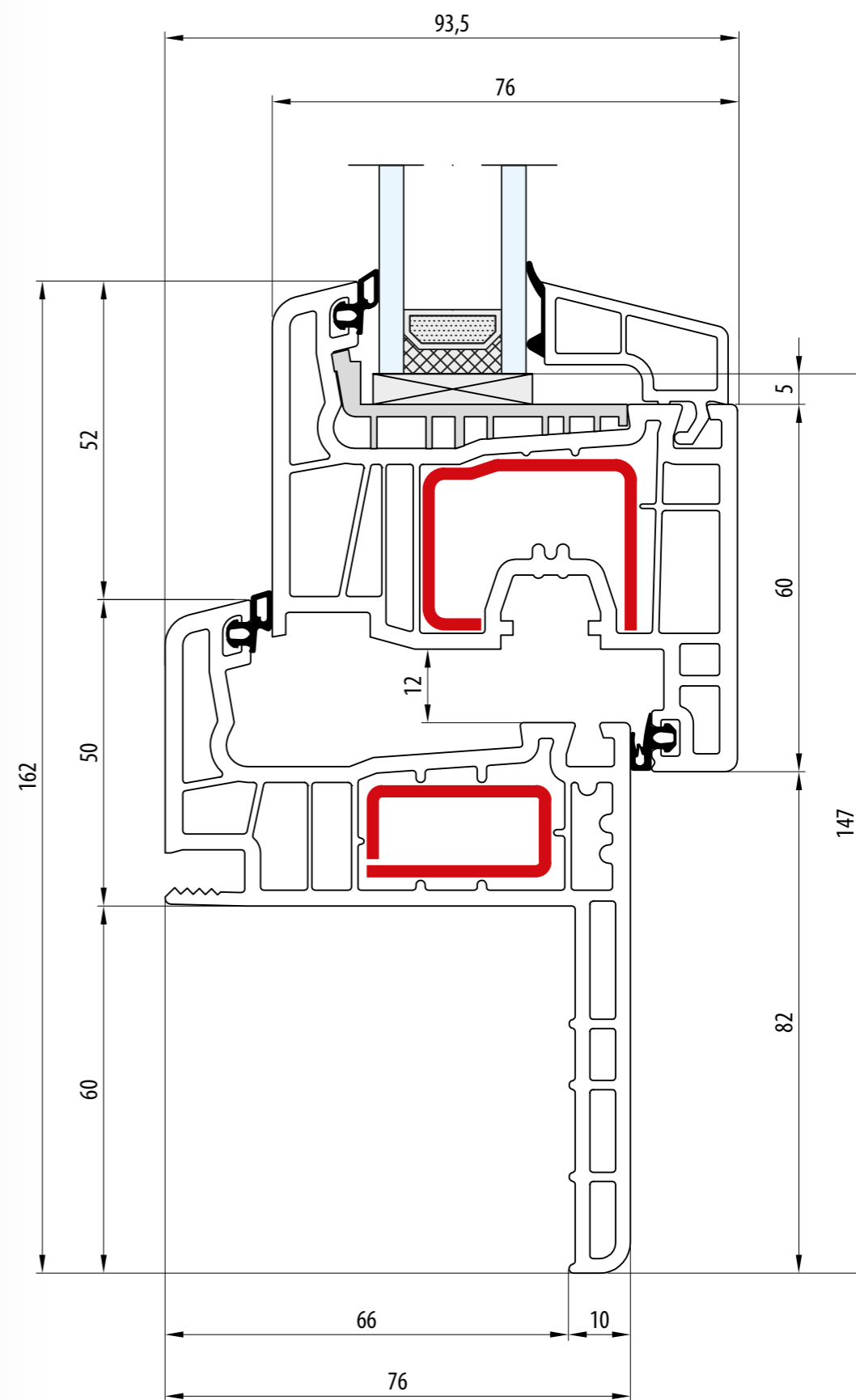
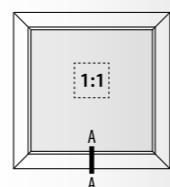

- RENOWACJA - Pletwa: 60 mm · Rama: 50 mm · Skrzydło: 80 mm
- RÉNOVATION - Lip: 60 mm · Dormant: 50 mm · Vantail: 80 mm
- RENOVATION - Strip: 60 mm · Frame: 50 mm · Sash: 80 mm
- RENOVIERUNG - Flosse: 60 mm · Rahmen: 50 mm · Flügel: 80 mm
- RINNOVAZIONE - Aletta da: 60 mm · Telaio: 50 mm · Anta: 80 mm

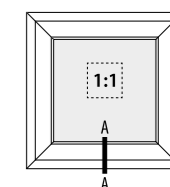

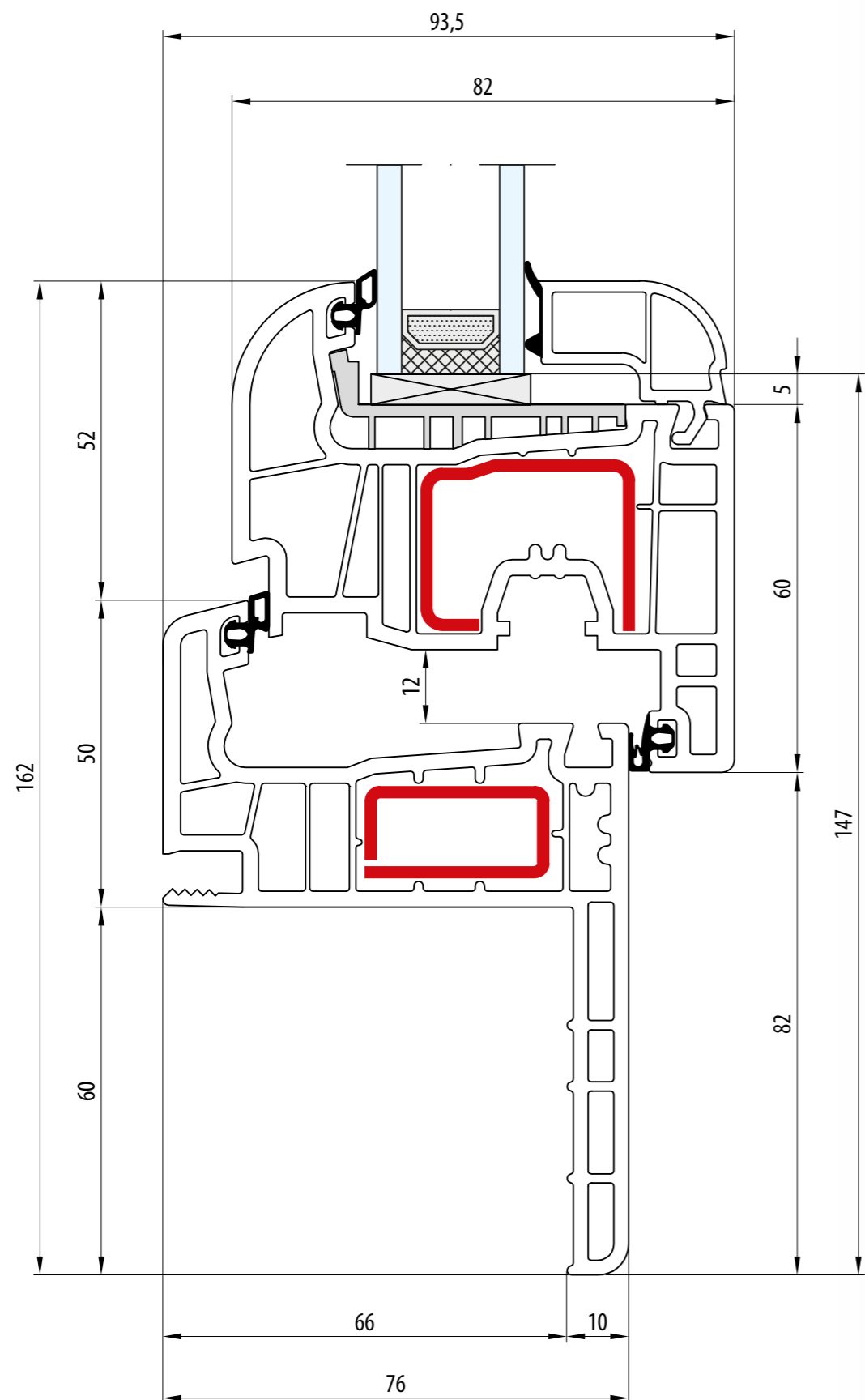

- RENOWACJA - Pletwa: 60 mm · Rama: 50 mm · Skrzydło: 80 mm
- RÉNOVATION - Lip: 60 mm · Dormant: 50 mm · Vantail: 80 mm
- RENOVATION - Strip: 60 mm · Frame: 50 mm · Sash: 80 mm
- RENOVIERUNG - Flosse: 60 mm · Rahmen: 50 mm · Flügel: 80 mm
- RINNOVAZIONE - Aletta da: 60 mm · Telaio: 50 mm · Anta: 80 mm

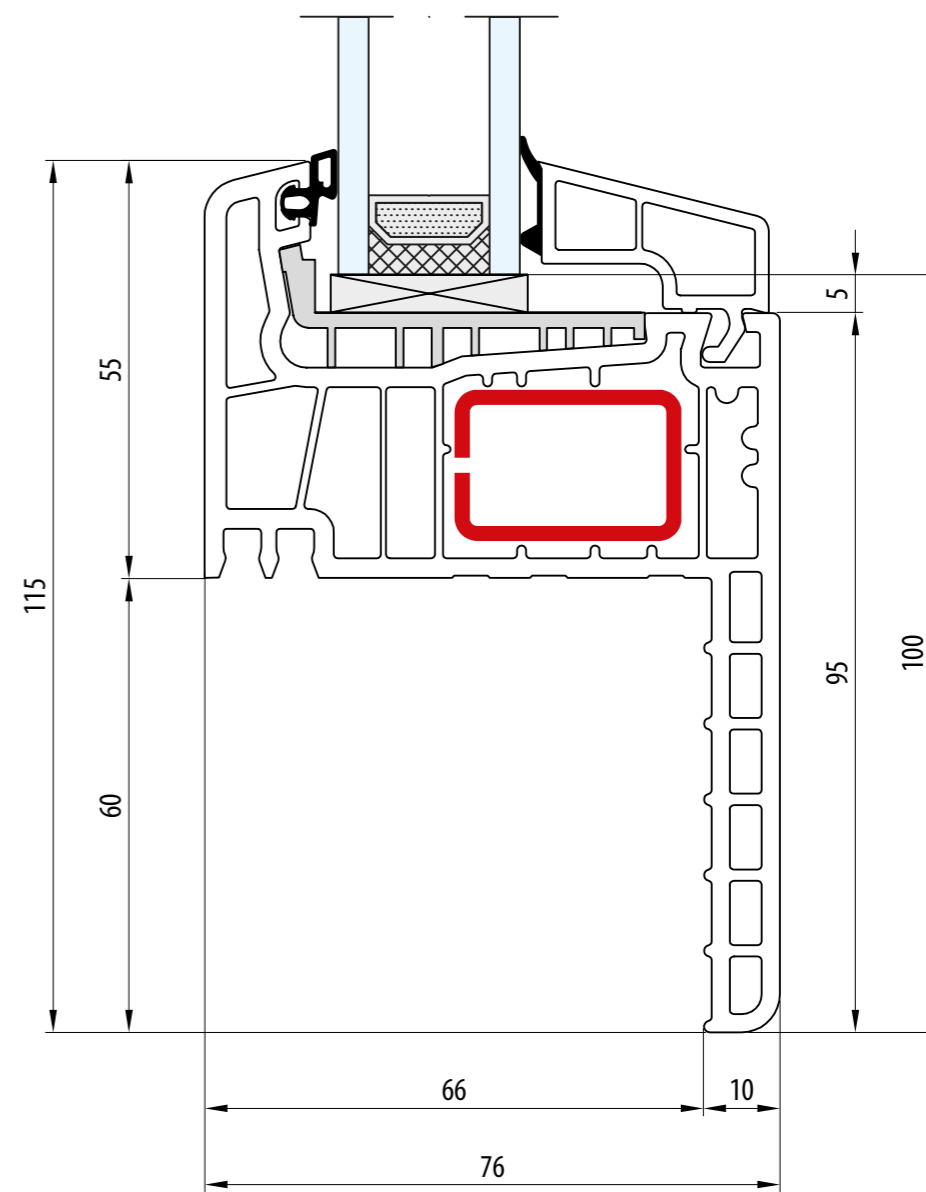
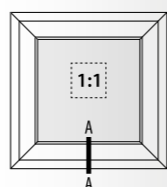

- RENOWACJA - Pletwa: 60 mm · Rama: 55 mm
- RÉNOVATION - Lip: 60 mm · Dormant: 55 mm
- RENOVATION - Strip: 60 mm · Frame: 55 mm
- RENOVIERUNG - Flosse: 60 mm · Rahmen: 55 mm
- RINNOVAZIONE - Aletta da: 60 mm · Telaio: 55 mm

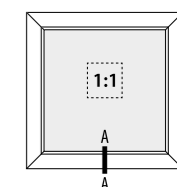

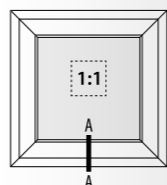
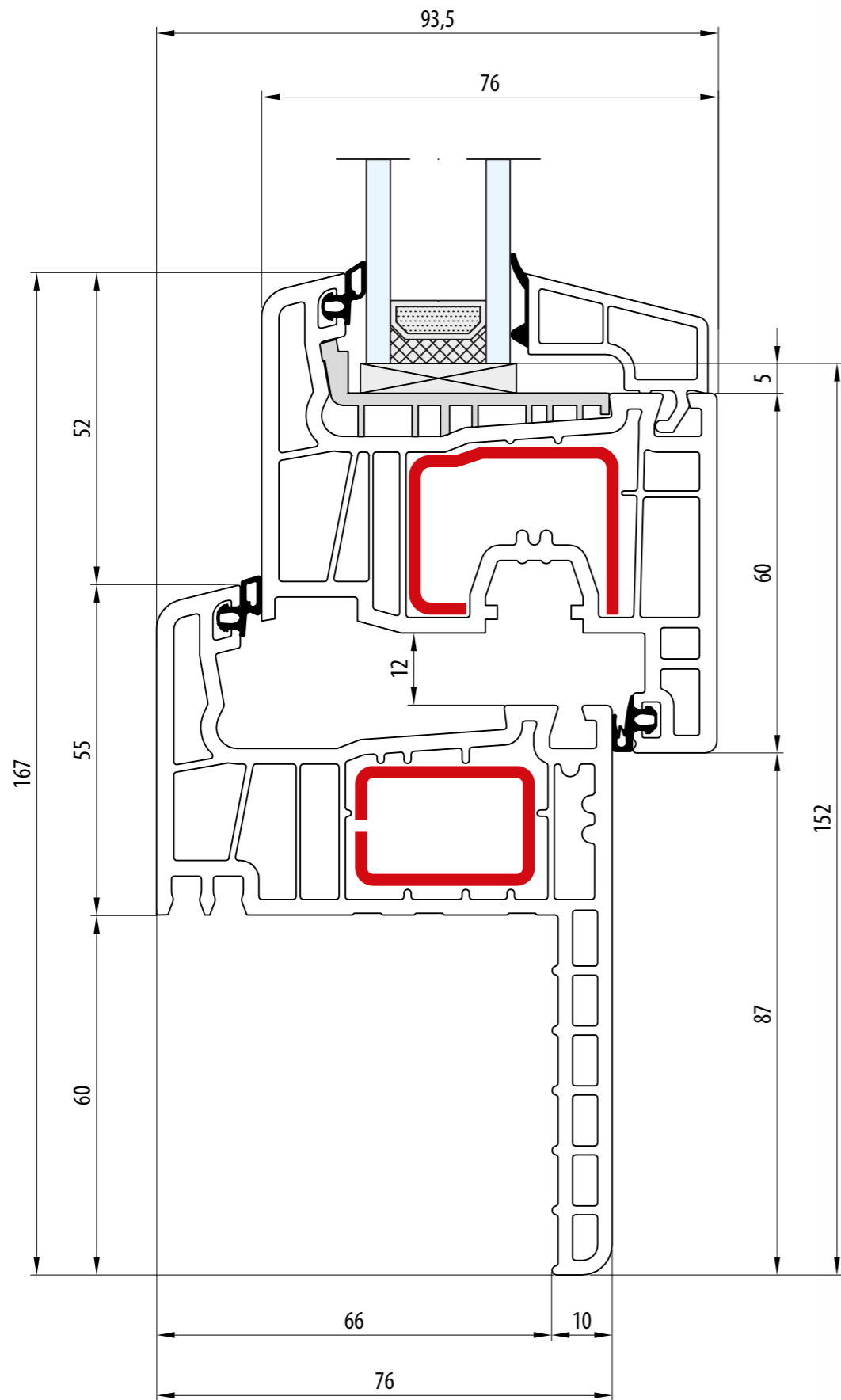

- RENOWACJA - Pletwa: 60 mm · Rama: 55 mm · Skrzydło: 80 mm
- RÉNOVATION - Lip: 60 mm · Dormant: 55 mm · Vantail: 80 mm
- RENOVATION - Strip: 60 mm · Frame: 55 mm · Sash: 80 mm
- RENOVIERUNG - Flosse: 60 mm · Rahmen: 55 mm · Flügel: 80 mm
- RINNOVAZIONE - Aletta da: 60 mm · Telaio: 55 mm · Anta: 80 mm

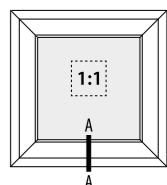
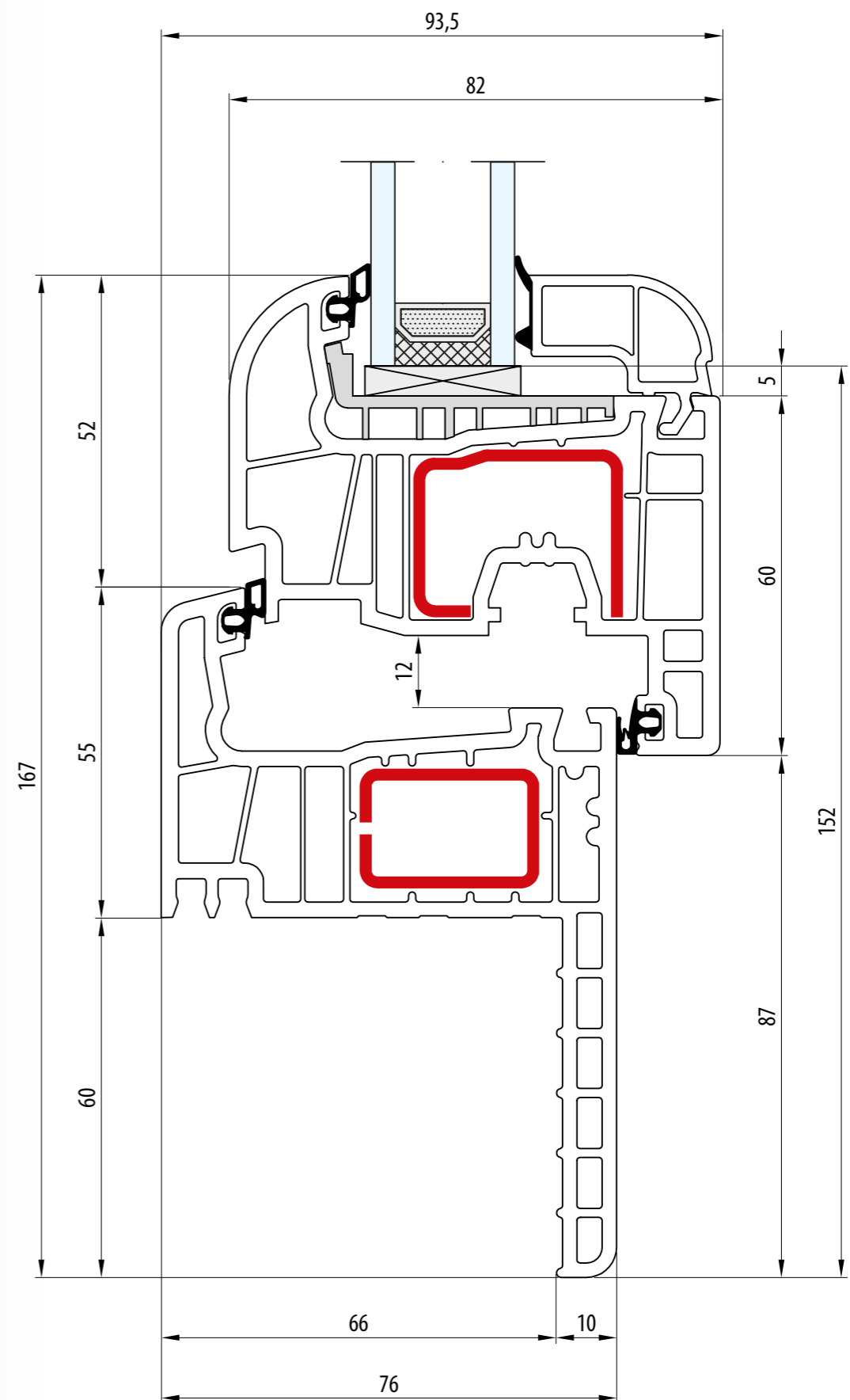

- RENOWACJA - Pletwa: 60 mm · Rama: 55 mm · Skrzydło: 80 mm
- RÉNOVATION - Lip: 60 mm · Dormant: 55 mm · Vantail: 80 mm
- RENOVATION - Strip: 60 mm · Frame: 55 mm · Sash: 80 mm
- RENOVIERUNG - Flosse: 60 mm · Rahmen: 55 mm · Flügel: 80 mm
- RINNOVAZIONE - Aletta da: 60 mm · Telaio: 55 mm · Anta: 80 mm

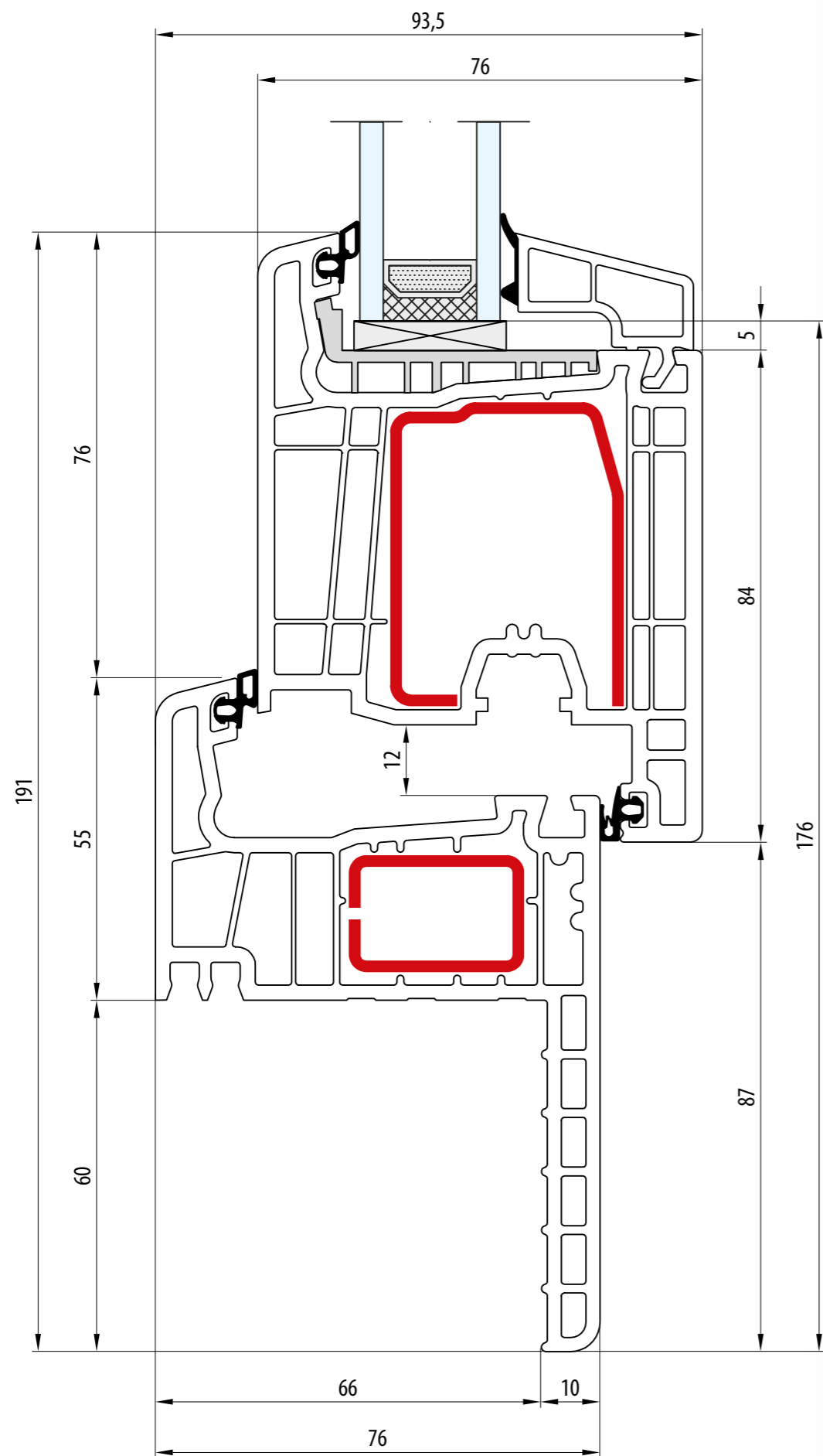

- RENOWACJA - Pletwa: 60 mm · Rama: 55 mm · Skrzydło: 104 mm
- RÉNOVATION - Lip: 60 mm · Dormant: 55 mm · Vantail: 104 mm
- RENOVATION - Strip: 60 mm · Frame: 55 mm · Sash: 104 mm
- RENOVIERUNG - Flosse: 60 mm · Rahmen: 55 mm · Flügel: 104 mm
- RINNOVAZIONE - Aletta da: 60 mm · Telaio: 55 mm · Anta: 104 mm

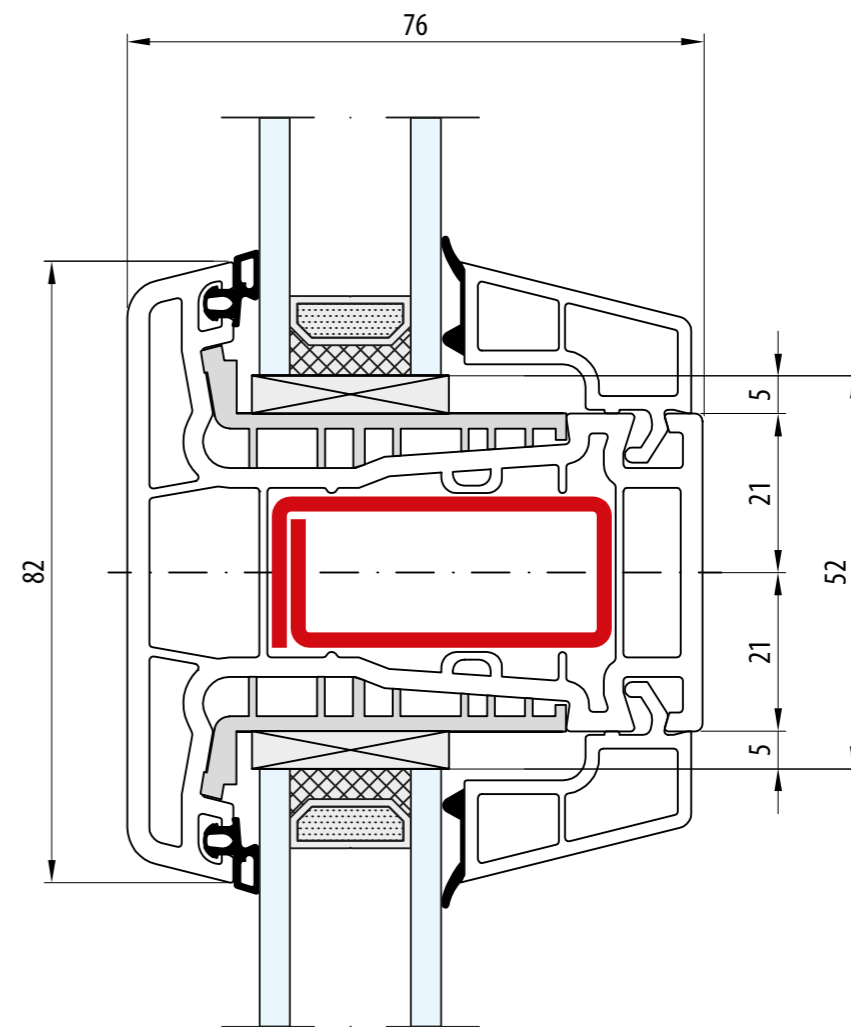
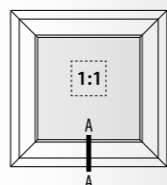

- Słupek staly: 82 mm
- Meneau fixe: 82 mm
- Fix post: 82 mm
- Festem Pfahl: 82 mm
- Montante fisso: 82 mm

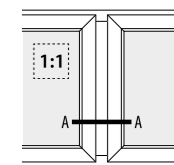

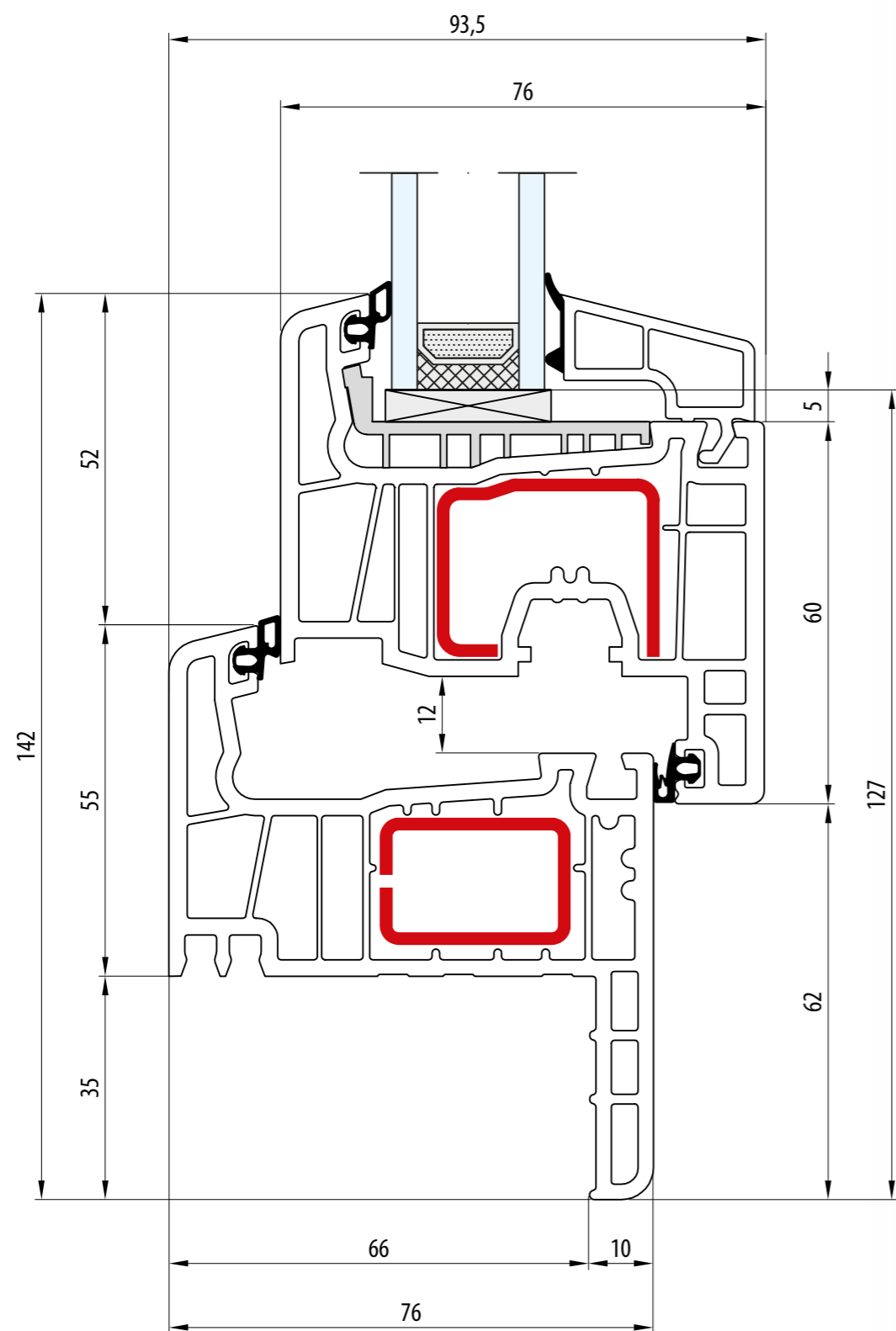

- RENOWACJA - Pletwa: 35 mm · Rama: 55 mm · Skrzydło: 80 mm
- RÉNOVATION - Lip: 35 mm · Dormant: 55 mm · Vantail: 80 mm
- RENOVATION - Strip: 35 mm · Frame: 55 mm · Sash: 80 mm
- RENOVIERUNG - Flosse: 35 mm · Rahmen: 55 mm · Flügel: 80 mm
- RINNOVAZIONE - Aletta da: 35 mm · Telaio: 55 mm · Anta: 80 mm

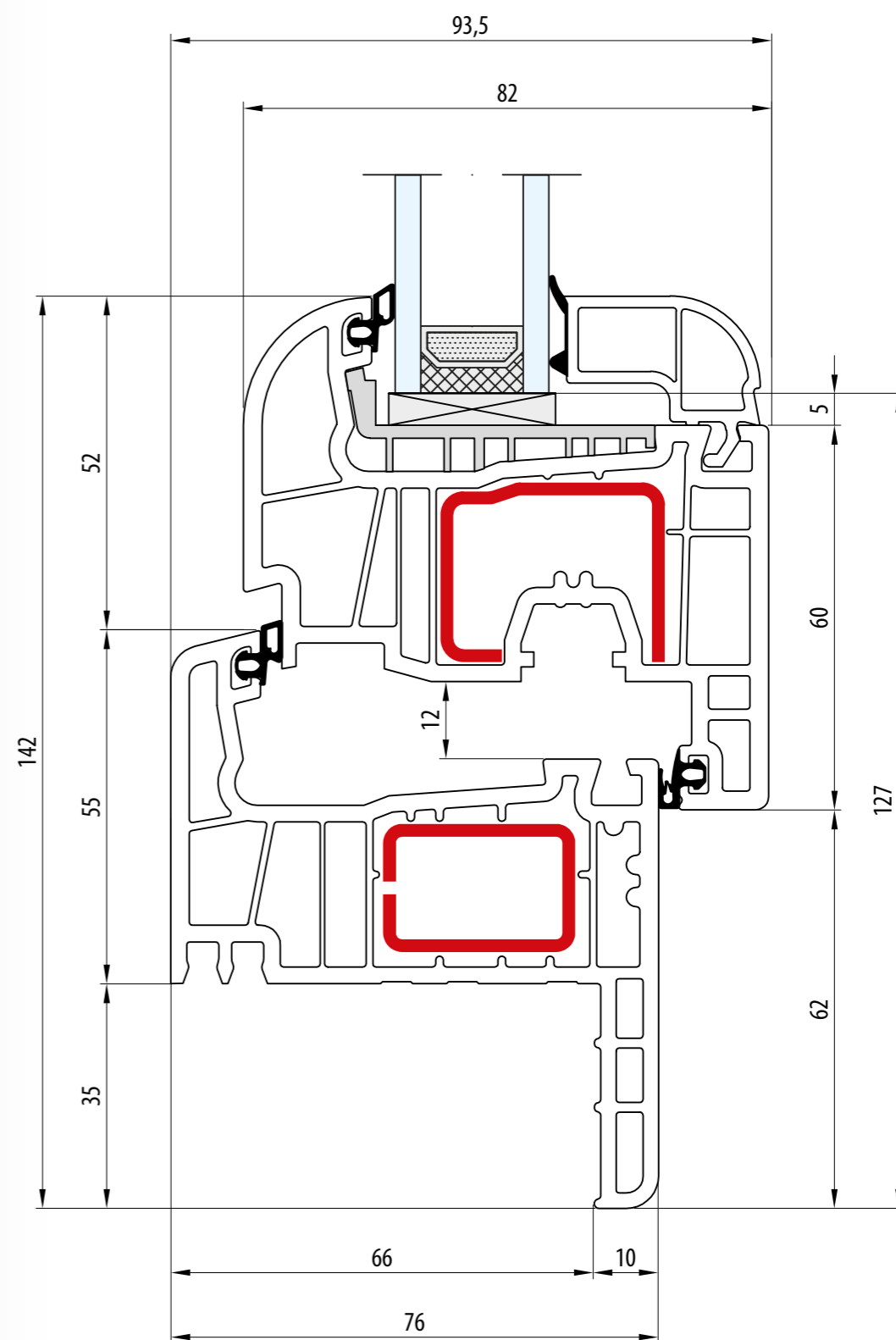
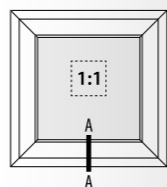

- RENOWACJA - Pletwa: 35 mm · Rama: 55 mm · Skrzydło: 80 mm
- RÉNOVATION - Lip: 35 mm · Dormant: 55 mm · Vantail: 80 mm
- RENOVATION - Strip: 35 mm · Frame: 55 mm · Sash: 80 mm
- RENOVIERUNG - Flosse: 35 mm · Rahmen: 55 mm · Flügel: 80 mm
- RINNOVAZIONE - Aletta da: 35 mm · Telaio: 55 mm · Anta: 80 mm

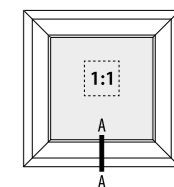



STREAMLINE 76

BLUEVOLUTION 82

BLUEVOLUTION 92

250 154 - 251 030

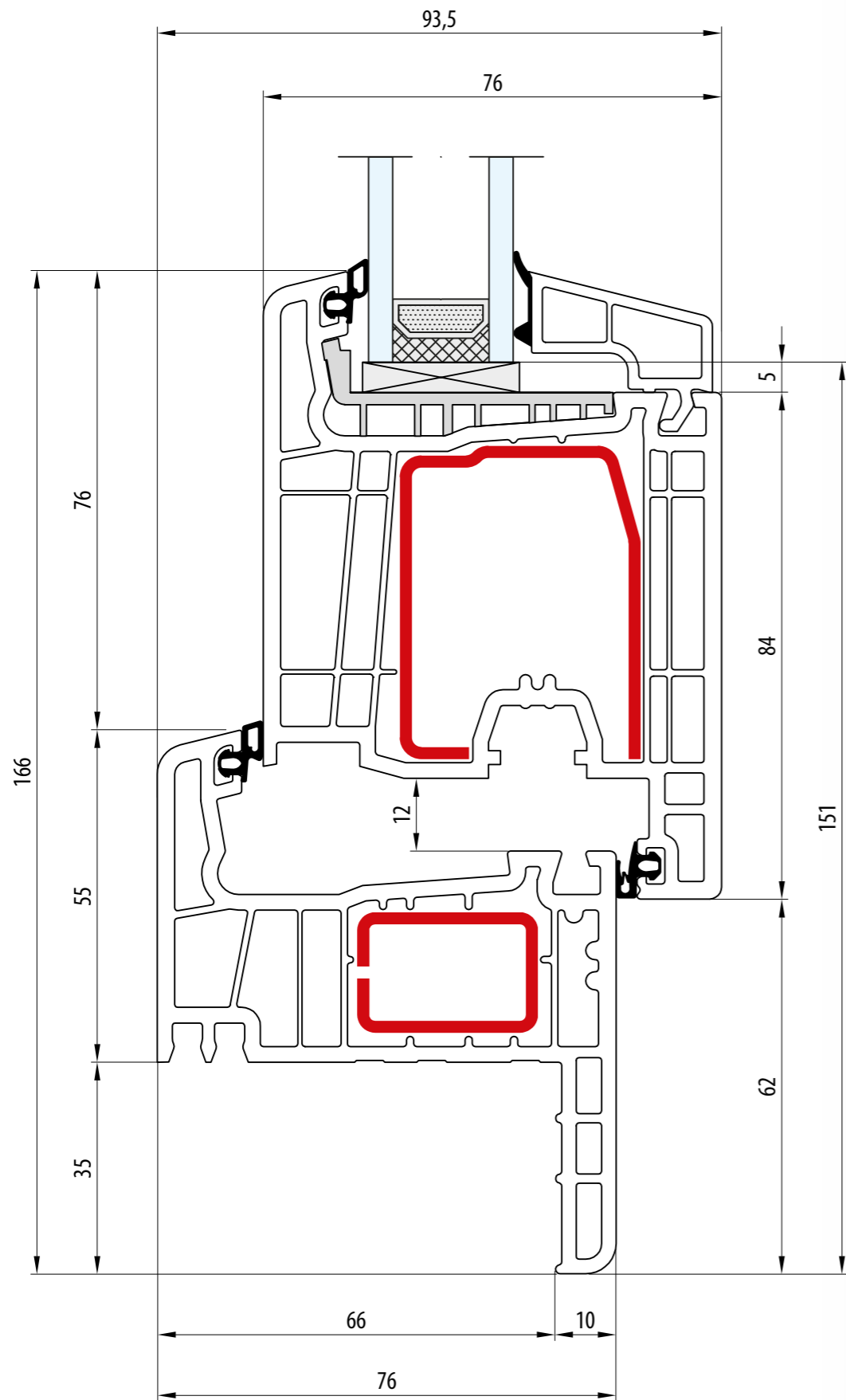

- RENOWACJA - Pletwa: 35 mm · Rama: 55 mm · Skrzydło: 104 mm
- RÉNOVATION - Lip: 35 mm · Dormant: 55 mm · Vantail: 104 mm
- RENOVATION - Strip: 35 mm · Frame: 55 mm · Sash: 104 mm
- RENOVIERUNG - Flosse: 35 mm · Rahmen: 55 mm · Flügel: 104 mm
- RINNOVAZIONE - Aletta da: 35 mm · Telaio: 55 mm · Anta: 104 mm

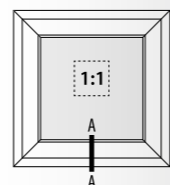

STREAMLINE 76

BLUEVOLUTION 82

BLUEVOLUTION 92

250 154

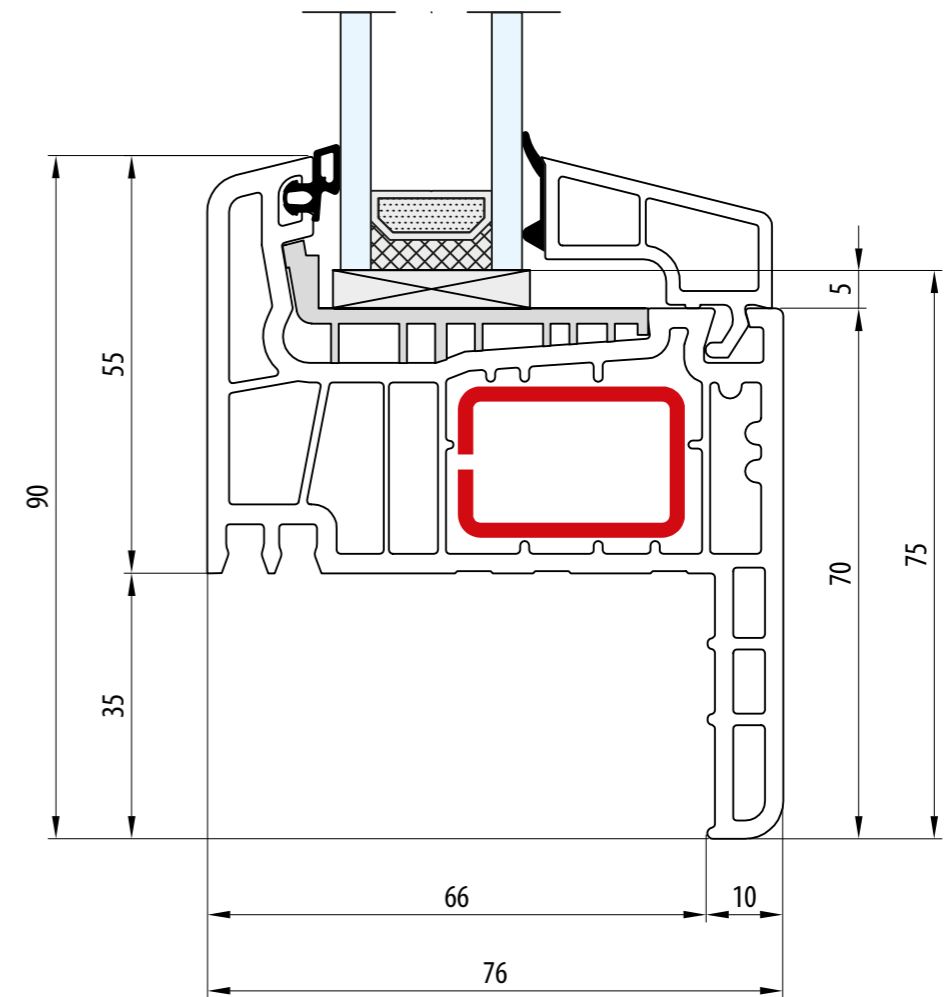

- RENOWACJA - Pletwa: 35 mm · Rama: 55 mm
- RÉNOVATION - Lip: 35 mm · Dormant: 55 mm
- RENOVATION - Strip: 35 mm · Frame: 55 mm
- RENOVIERUNG - Flosse: 35 mm · Rahmen: 55 mm
- RINNOVAZIONE - Aletta da: 35 mm · Telaio: 55 mm

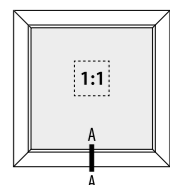

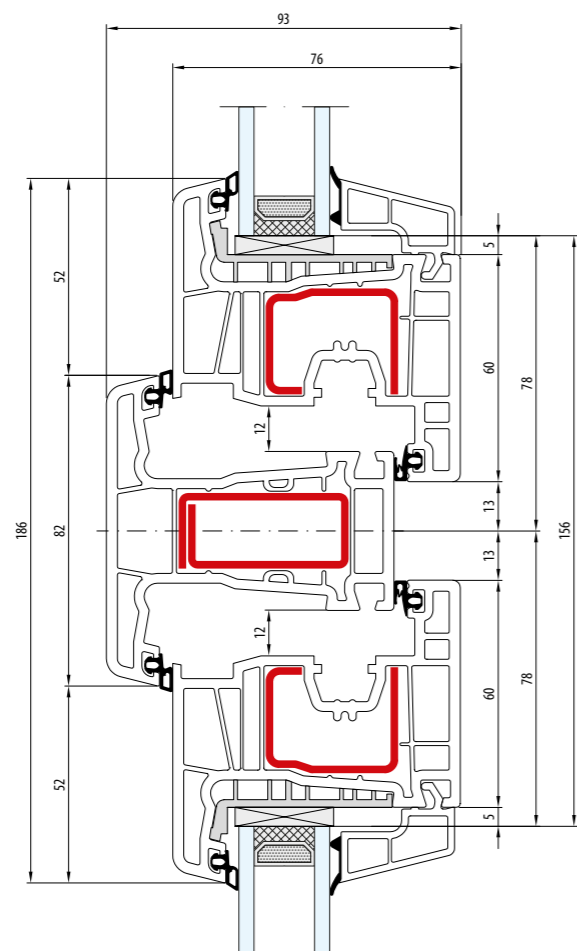

- Słupek stalowy: 82 mm · Skrzydło: 80 mm
- Meneau fixe: 82 mm · Vantail: 80 mm
- Fix post: 82 mm · Sash: 80 mm
- Festem Pfahl: 82 mm · Flügel: 80 mm
- Montante fisso: 82 mm · Anta: 80 mm

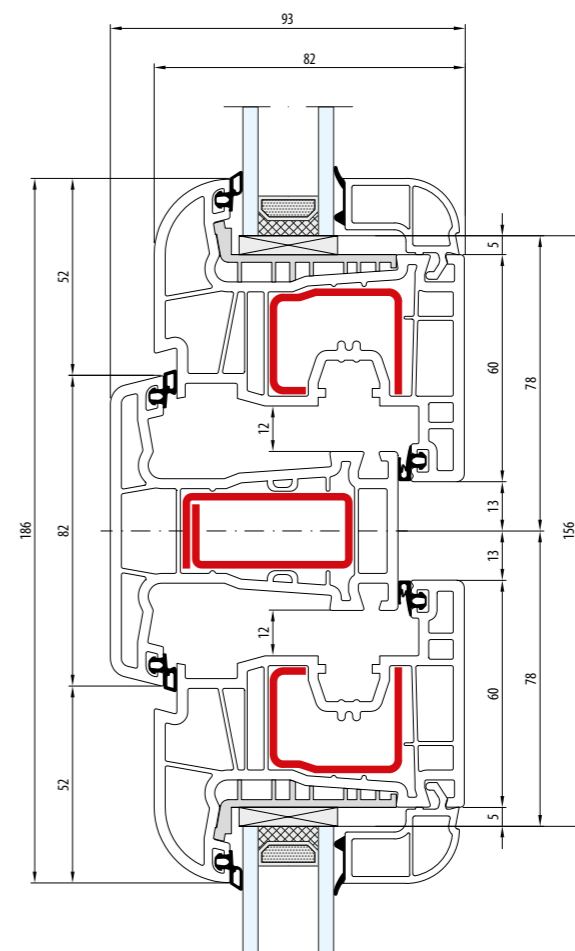
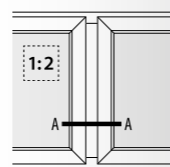

- Słupek stalowy: 82 mm · Skrzydło: 80 mm
- Meneau fixe: 82 mm · Vantail: 80 mm
- Fix post: 82 mm · Sash: 80 mm
- Festem Pfahl: 82 mm · Flügel: 80 mm
- Montante fisso: 82 mm · Anta: 80 mm

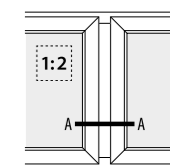

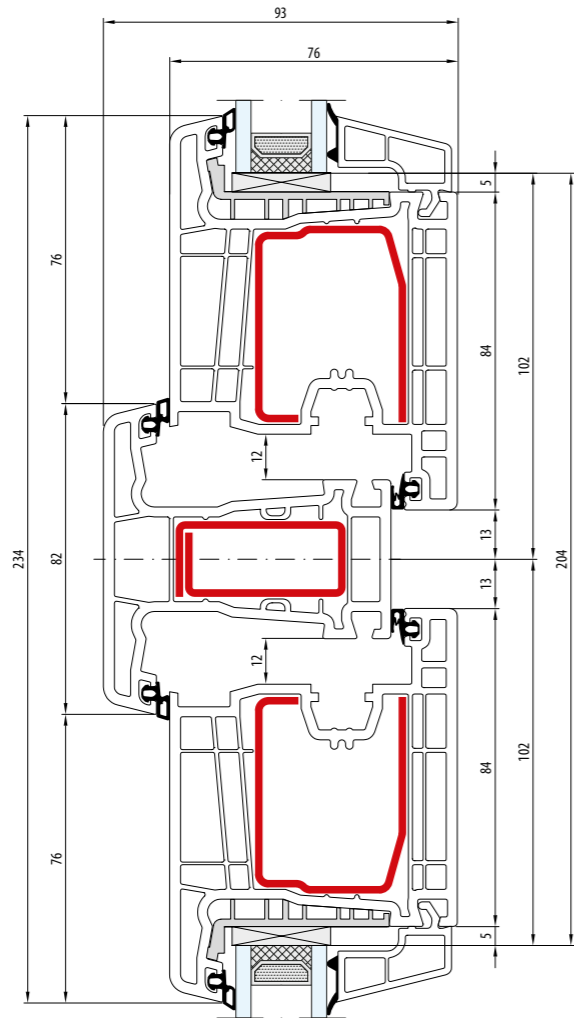



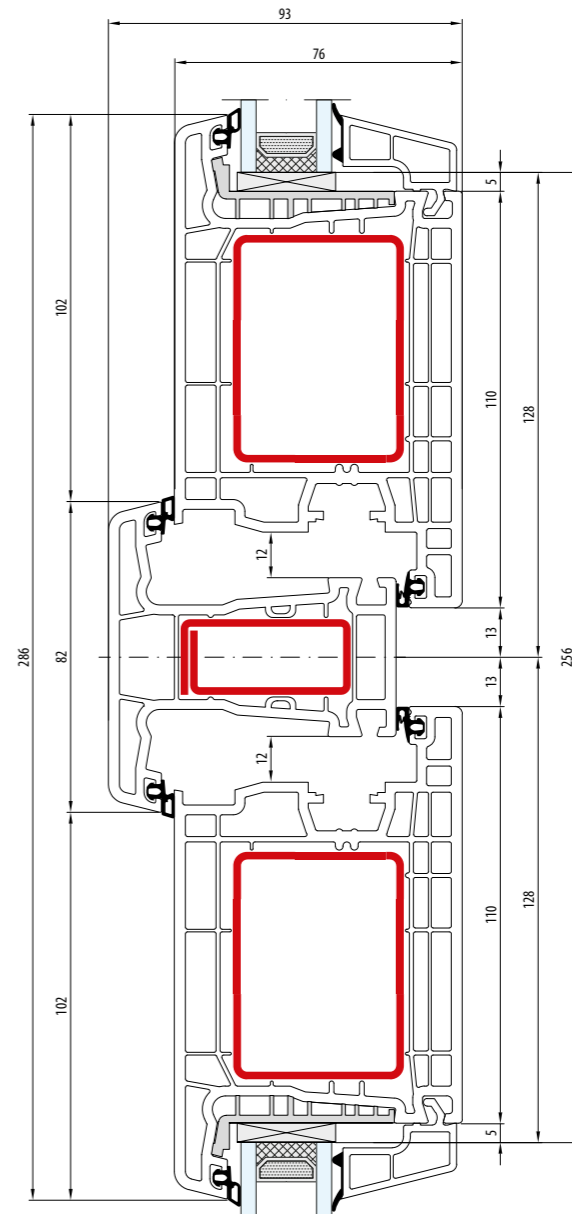
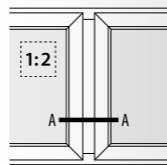

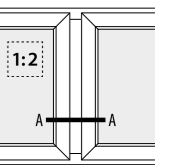

- Słupek stalowy: 82 mm · Skrzydło: 104 mm
- Meneau fixe: 82 mm · Vantail: 104 mm
- Fix post: 82 mm · Sash: 104 mm
- Festem Pfahl: 82 mm · Flügel: 104 mm
- Montante fisso: 82 mm · Anta: 104 mm

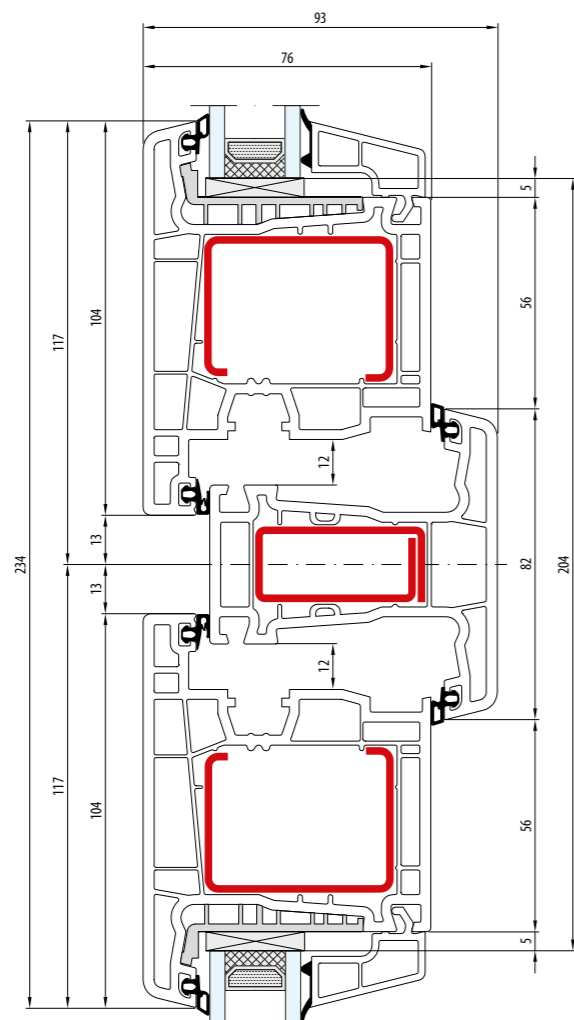



- Słupek stalowy: 82 mm · Skrzydło: 130 mm
- Meneau fixe: 82 mm · Vantail: 130 mm
- Fix post: 82 mm · Sash: 130 mm
- Festem Pfahl: 82 mm · Flügel: 130 mm
- Montante fisso: 82 mm · Anta: 130 mm



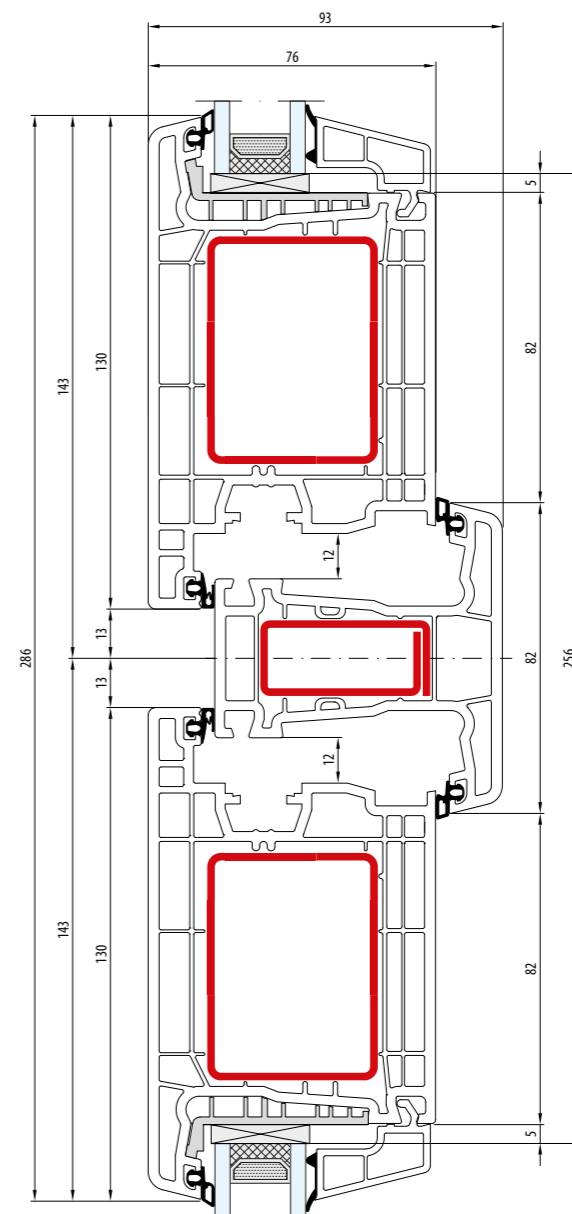
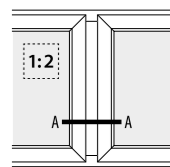
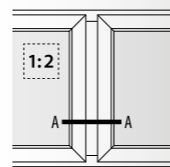

-  Słupek stały: 82 mm · Skrzydło: 104 mm
-  Meneau fixe: 82 mm · Vantail: 104 mm
-  Fix post: 82 mm · Sash: 104 mm
-  Festem Pfahl: 82 mm · Flügel: 104 mm
-  Montante fisso: 82 mm · Anta: 104 mm



-  Słupek stały: 82 mm · Skrzydło: 130 mm
-  Meneau fixe: 82 mm · Vantail: 130 mm
-  Fix post: 82 mm · Sash: 130 mm
-  Festem Pfahl: 82 mm · Flügel: 130 mm
-  Montante fisso: 82 mm · Anta: 130 mm

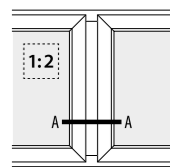

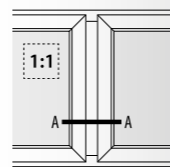
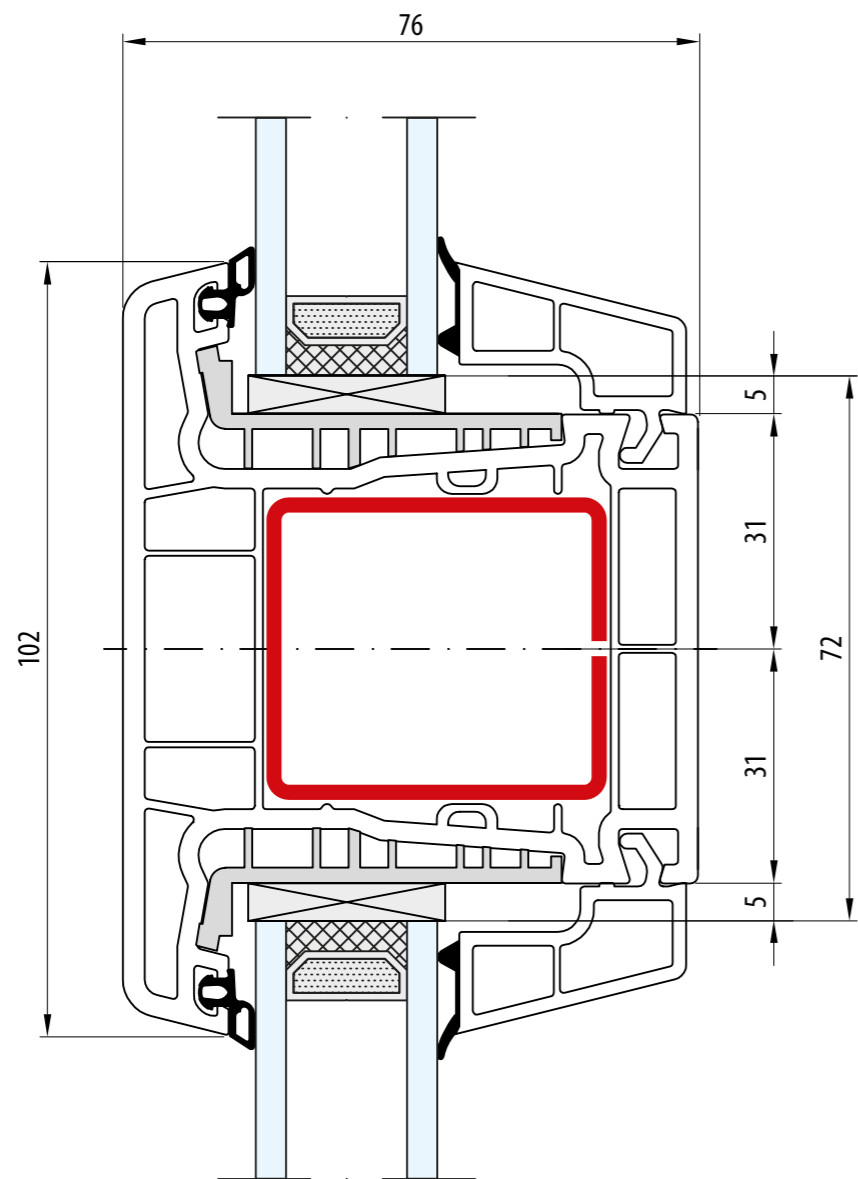

- Słupek stały: 102 mm
- Meneau fixe: 102 mm
- Fix post: 102 mm
- Festem Pfahl: 102 mm
- Montante fisso: 102 mm

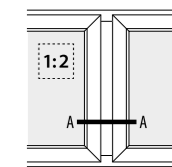
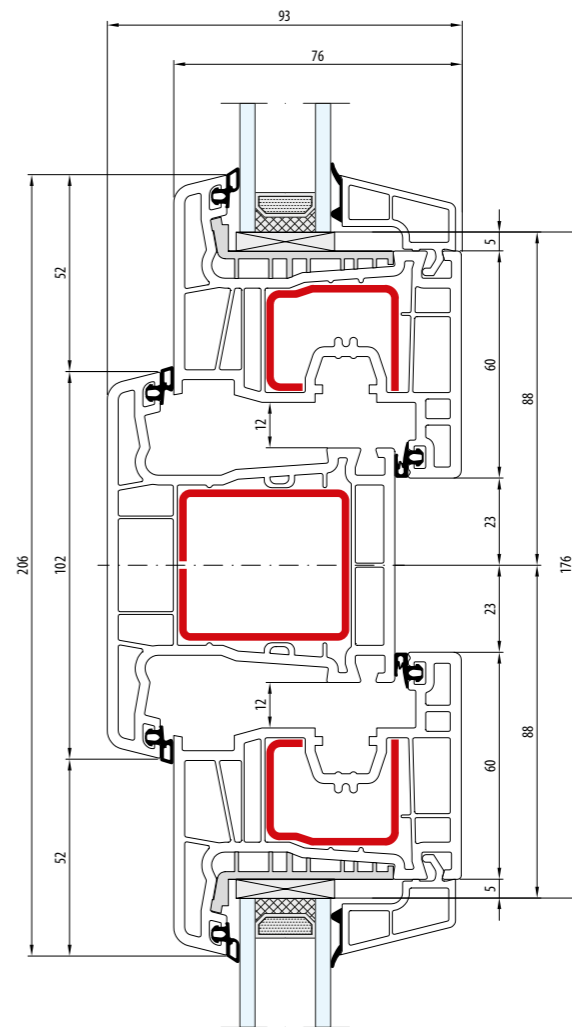

- Słupek stały: 102 mm · Skrzydło: 80 mm
- Meneau fixe: 102 mm · Vantail: 80 mm
- Fix post: 102 mm · Sash: 80 mm
- Festem Pfahl: 102 mm · Flügel: 80 mm
- Montante fisso: 102 mm · Anta: 80 mm

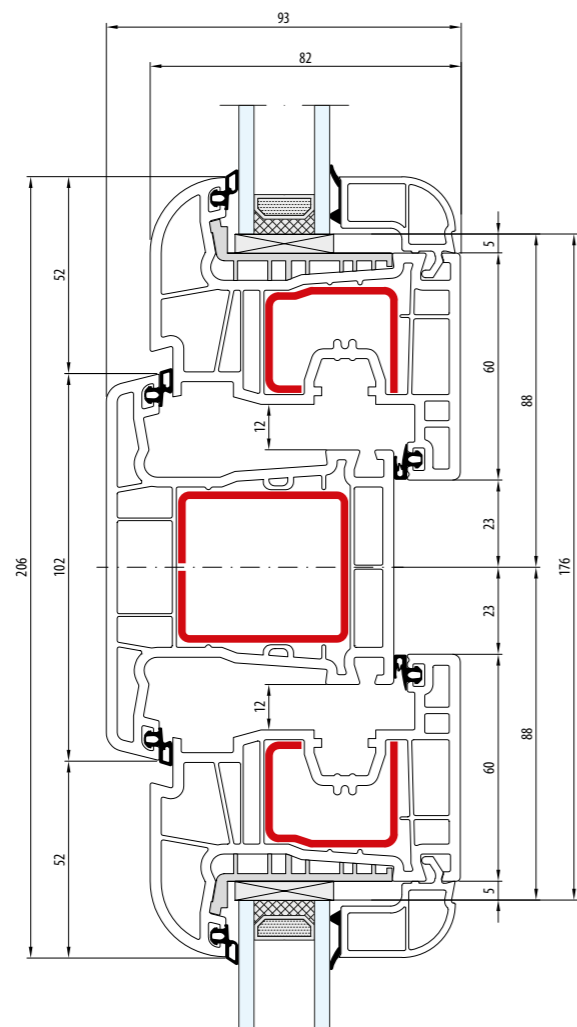

- Słupek stały: 102 mm · Skrzydło: 80 mm
- Meneau fixe: 102 mm · Vantail: 80 mm
- Fix post: 102 mm · Sash: 80 mm
- Festem Pfahl: 102 mm · Flügel: 80 mm
- Montante fisso: 102 mm · Anta: 80 mm

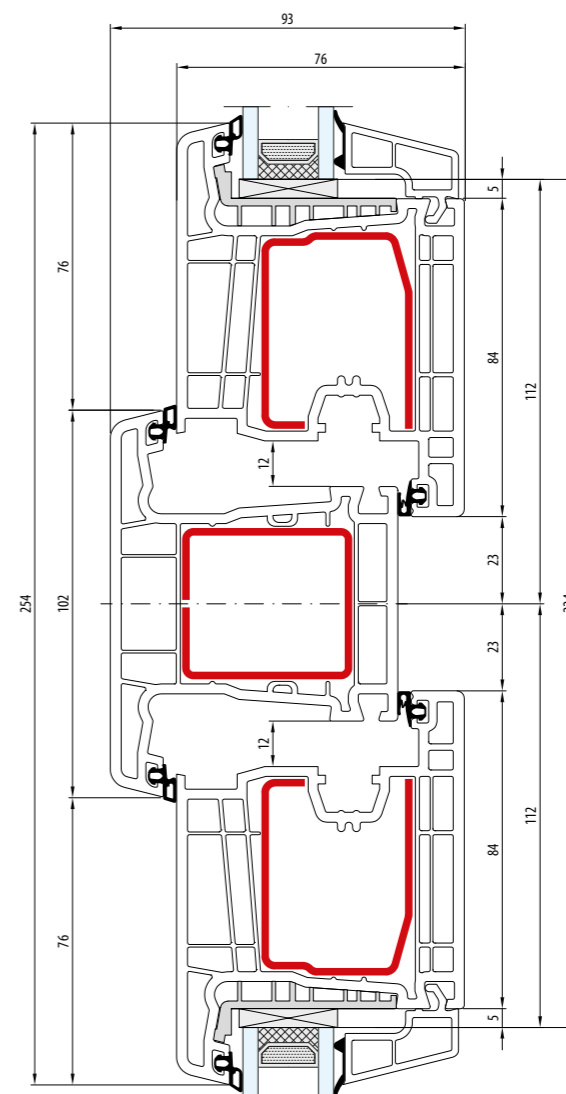
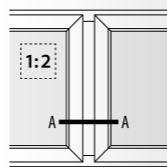

- Słupek stały: 102 mm · Skrzydło: 104 mm
- Meneau fixe: 102 mm · Vantail: 104 mm
- Fix post: 102 mm · Sash: 104 mm
- Festem Pfahl: 102 mm · Flügel: 104 mm
- Montante fisso: 102 mm · Anta: 104 mm

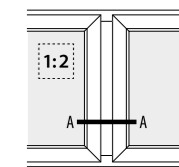

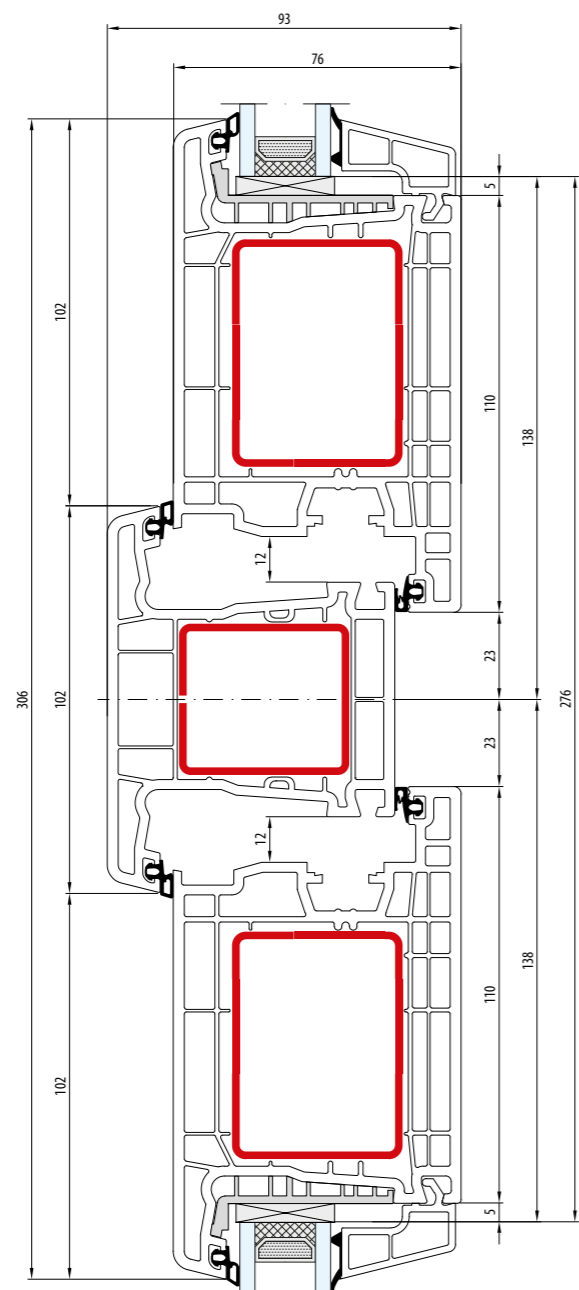

- Słupek stały: 102 mm · Skrzydło: 130 mm
- Meneau fixe: 102 mm · Vantail: 130 mm
- Fix post: 102 mm · Sash: 130 mm
- Festem Pfahl: 102 mm · Flügel: 130 mm
- Montante fisso: 102 mm · Anta: 130 mm

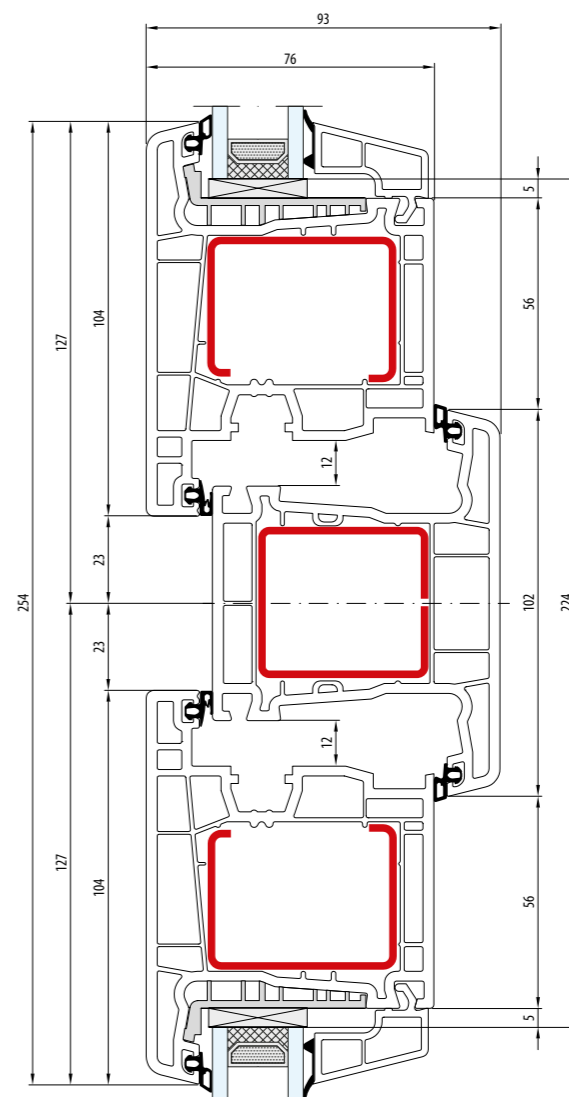
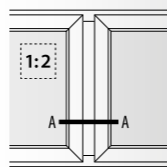

- Słupek stały: 102 mm · Skrzydło: 104 mm
- Meneau fixe: 102 mm · Vantail: 104 mm
- Fix post: 102 mm · Sash: 104 mm
- Festem Pfahl: 102 mm · Flügel: 104 mm
- Montante fisso: 102 mm · Anta: 104 mm

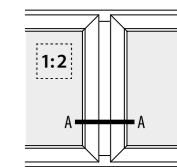

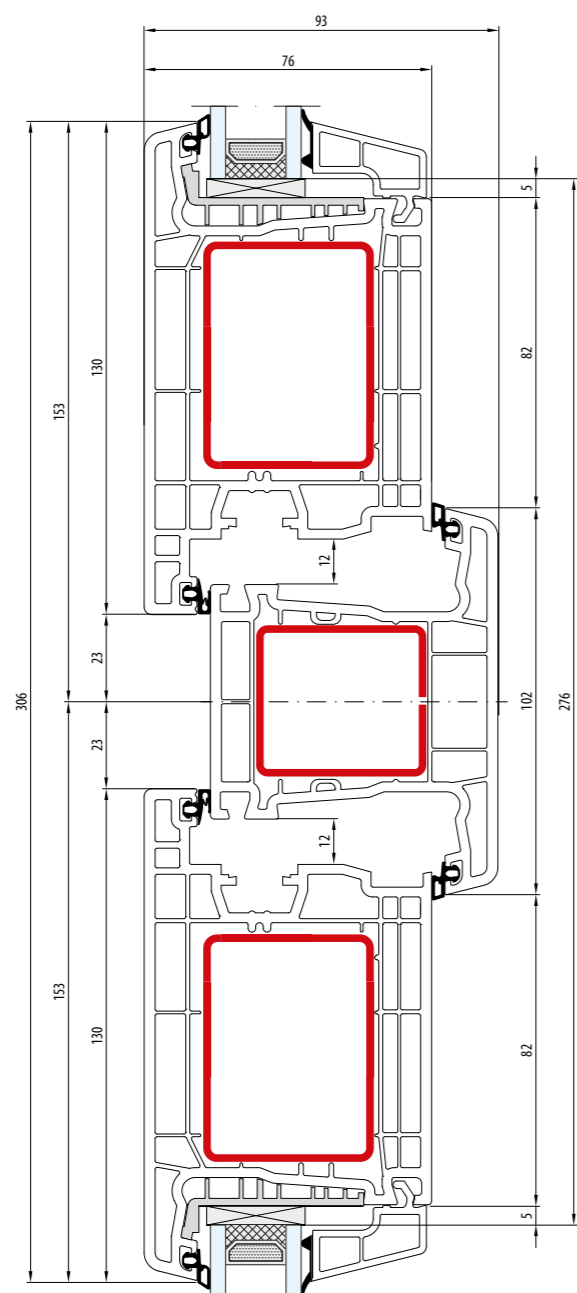

- Słupek stały: 102 mm · Skrzydło: 130 mm
- Meneau fixe: 102 mm · Vantail: 130 mm
- Fix post: 102 mm · Sash: 130 mm
- Festem Pfahl: 102 mm · Flügel: 130 mm
- Montante fisso: 102 mm · Anta: 130 mm

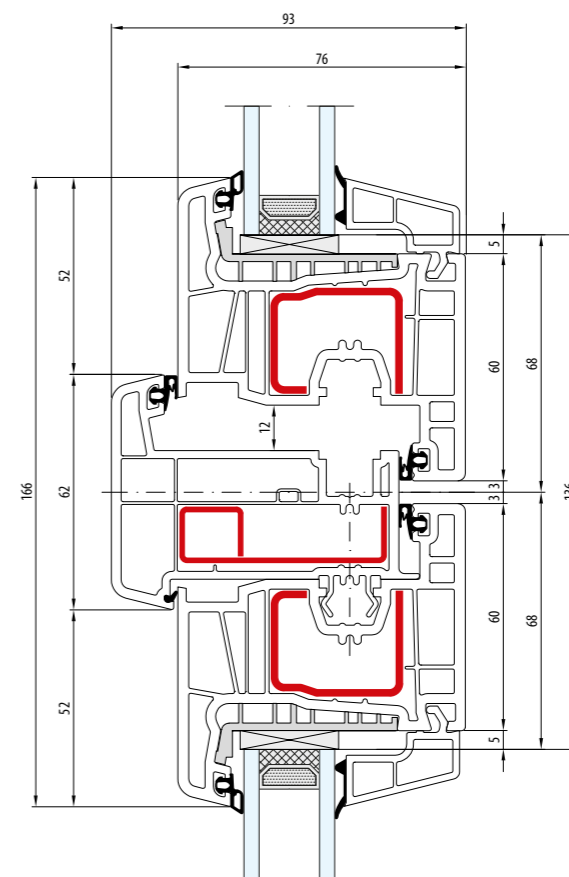
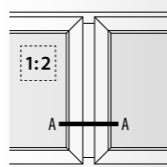

- Słupek ruchomy: 62 mm · Skrzydło: 80 mm
- Meneau mobile: 62 mm · Vantail: 80 mm
- Movable post: 62 mm · Sash: 80 mm
- Stulp: 62 mm · Flügel: 80 mm
- Montante mobile: 62 mm · Anta: 80 mm

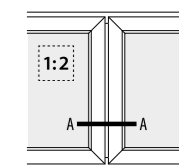

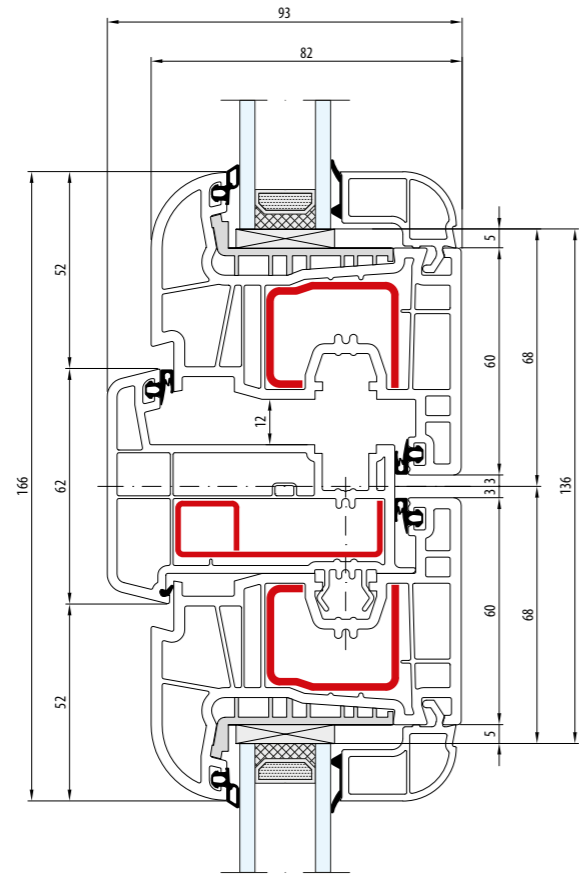

- Słupek ruchomy: 62 mm · Skrzydło: 80 mm
- Meneau mobile: 62 mm · Vantail: 80 mm
- Movable post: 62 mm · Sash: 80 mm
- Stulp: 62 mm · Flügel: 80 mm
- Montante mobile: 62 mm · Anta: 80 mm

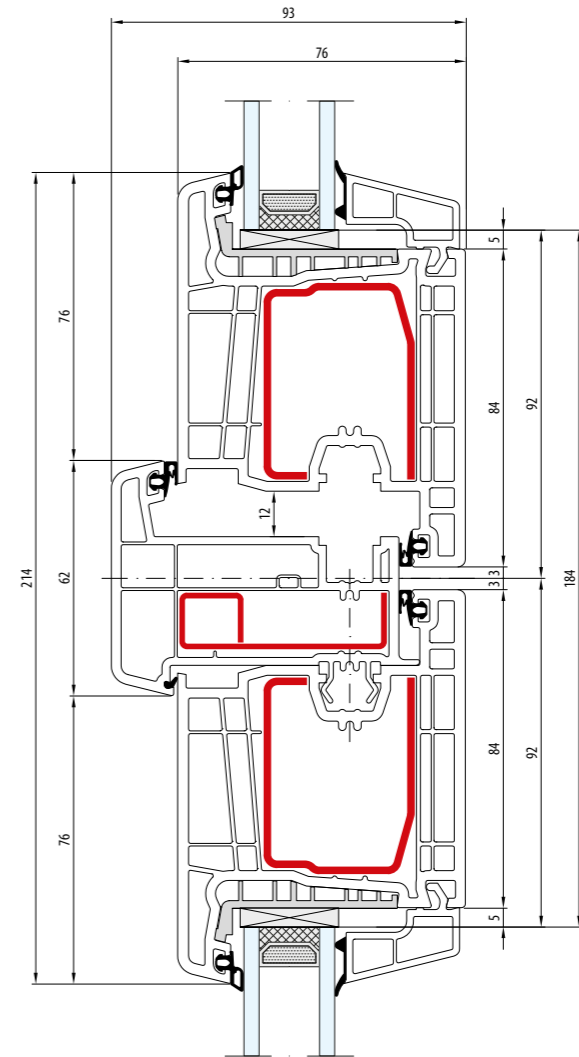
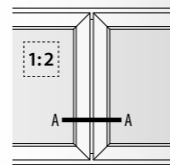

- Słupek ruchomy: 62 mm · Skrzydło: 104 mm
- Meneau mobile: 62 mm · Vantail: 104 mm
- Movable post: 62 mm · Sash: 104 mm
- Stulp: 62 mm · Flügel: 104 mm
- Montante mobile: 62 mm · Anta: 104 mm

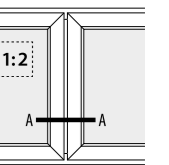

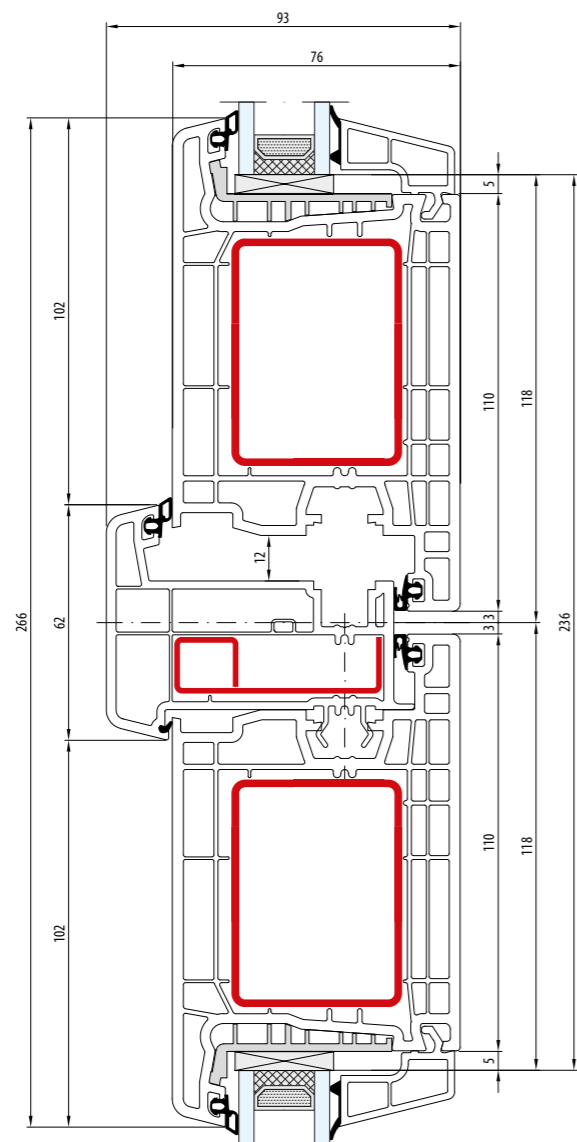

- Słupek ruchomy: 62 mm · Skrzydło: 130 mm
- Meneau mobile: 62 mm · Vantail: 130 mm
- Movable post: 62 mm · Sash: 130 mm
- Stulp: 62 mm · Flügel: 130 mm
- Montante mobile: 62 mm · Anta: 130 mm

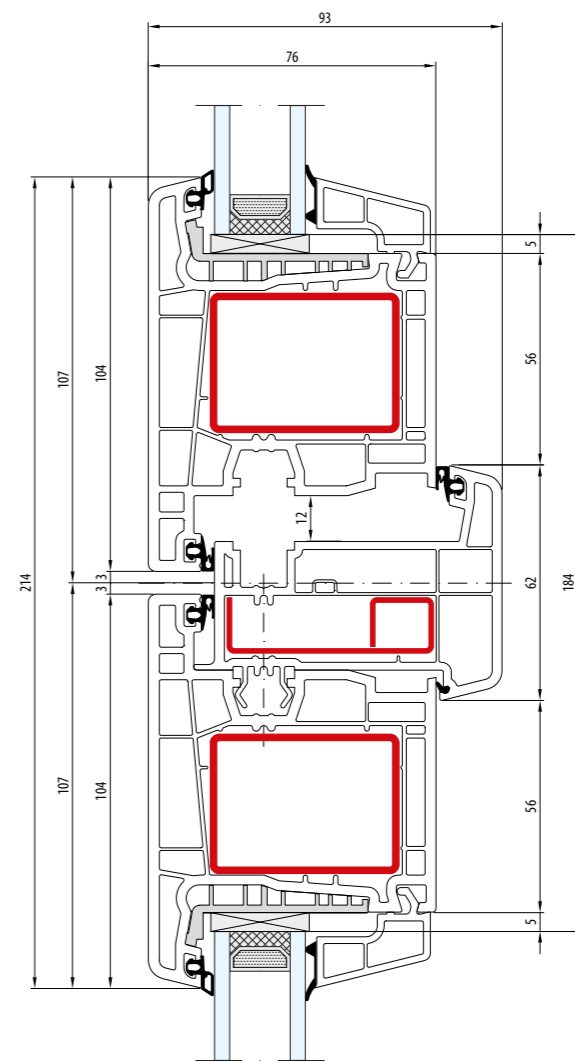
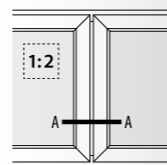

- Słupek ruchomy: 62 mm · Skrzydło: 104 mm
- Meneau mobile: 62 mm · Vantail: 104 mm
- Movable post: 62 mm · Sash: 104 mm
- Stulp: 62 mm · Flügel: 104 mm
- Montante mobile: 62 mm · Anta: 104 mm

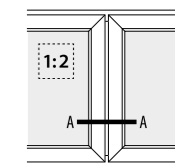

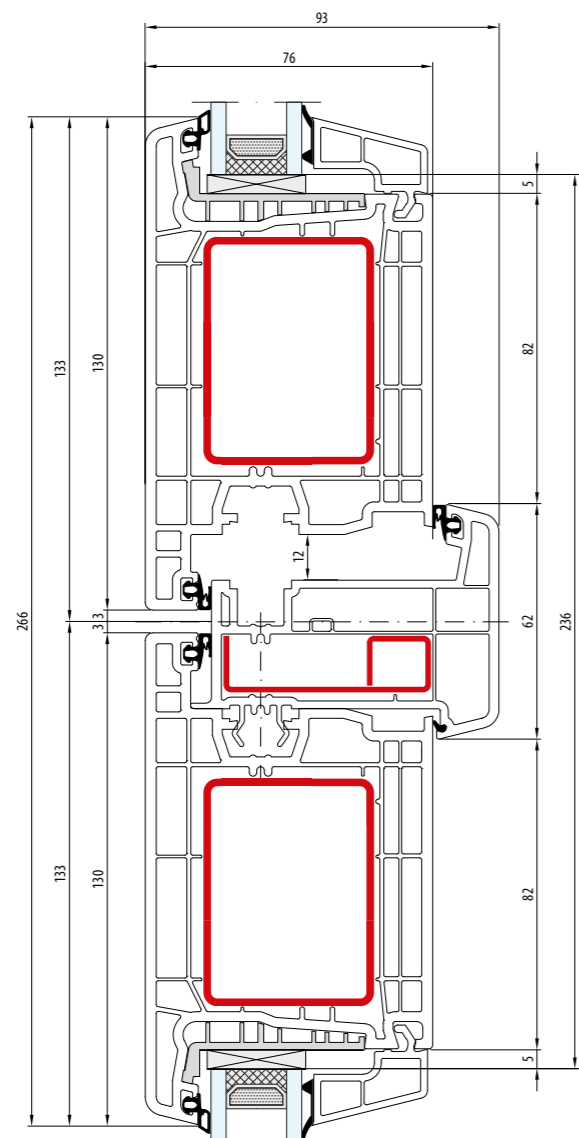



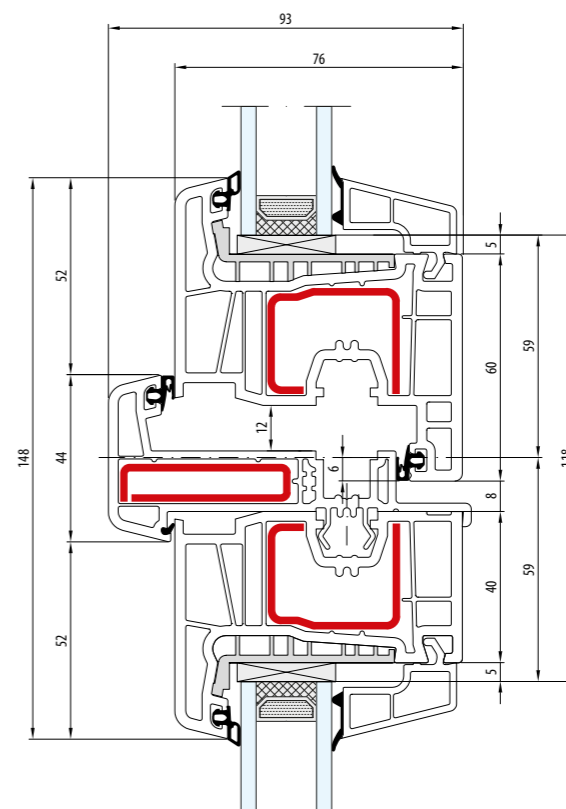
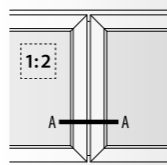

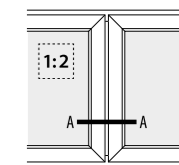

- Słupek ruchomy: 62 mm · Skrzydło: 130 mm
- Meneau mobile: 62 mm · Vantail: 130 mm
- Movable post: 62 mm · Sash: 130 mm
- Stulp: 62 mm · Flügel: 130 mm
- Montante mobile: 62 mm · Anta: 130 mm

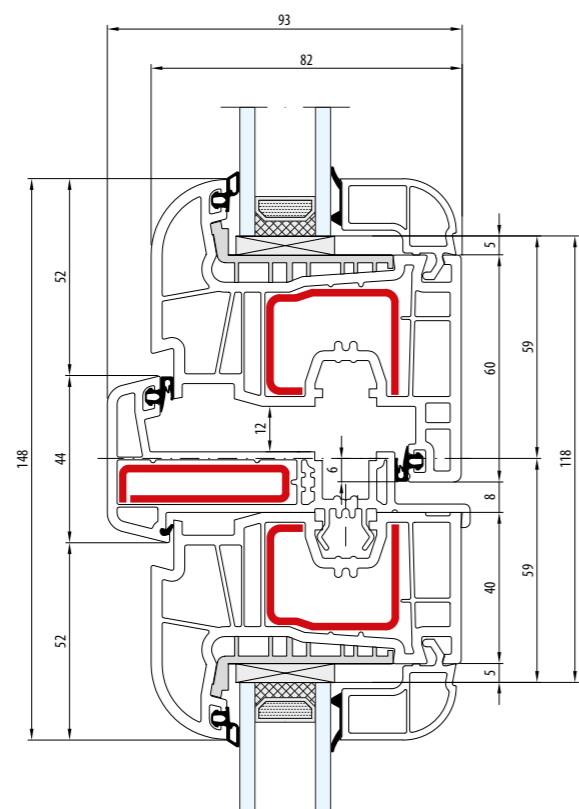





- Słupek ruchomy: 44 mm · Skrzydło: 80 mm / 60 mm
- Meneau mobile: 44 mm · Vantail: 80 mm / 60 mm
- Movable post: 44 mm · Sash: 80 mm / 60 mm
- Stulp: 44 mm · Flügel: 80 mm / 60 mm
- Montante mobile: 44 mm · Anta: 80 mm / 60 mm



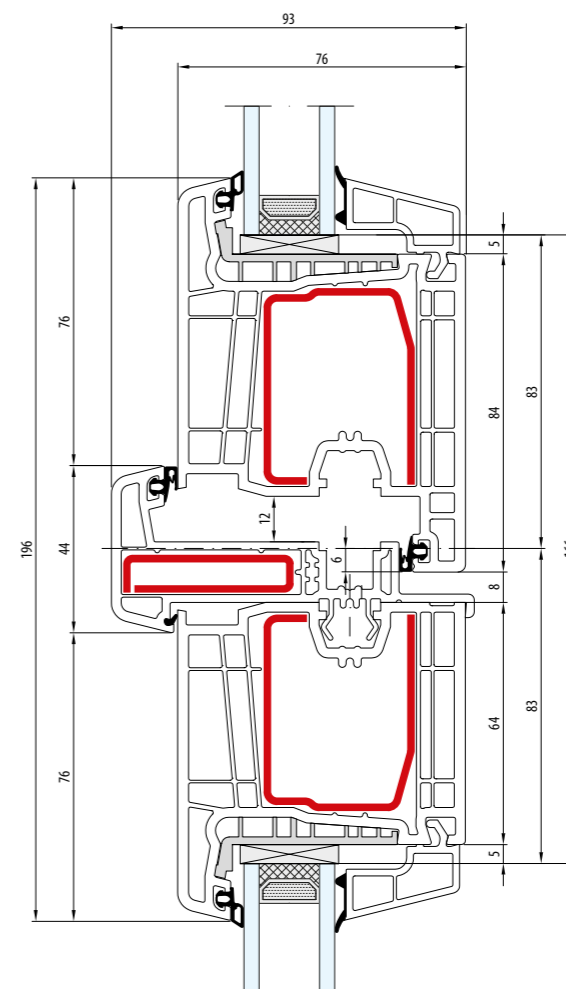
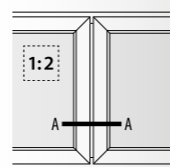

-  Słupek ruchomy: 44 mm · Skrzydło: 80 mm / 60 mm
-  Meneau mobile: 44 mm · Vantail: 80 mm / 60 mm
-  Movable post: 44 mm · Sash: 80 mm / 60 mm
-  Stulp: 44 mm · Flügel: 80 mm / 60 mm
-  Montante mobile: 44 mm · Anta: 80 mm / 60 mm



-  Słupek ruchomy: 44 mm · Skrzydło: 104 mm / 84 mm
-  Meneau mobile: 44 mm · Vantail: 104 mm / 84 mm
-  Movable post: 44 mm · Sash: 104 mm / 84 mm
-  Stulp: 44 mm · Flügel: 104 mm / 84 mm
-  Montante mobile: 44 mm · Anta: 104 mm / 84 mm

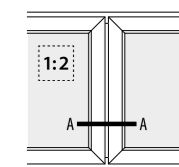

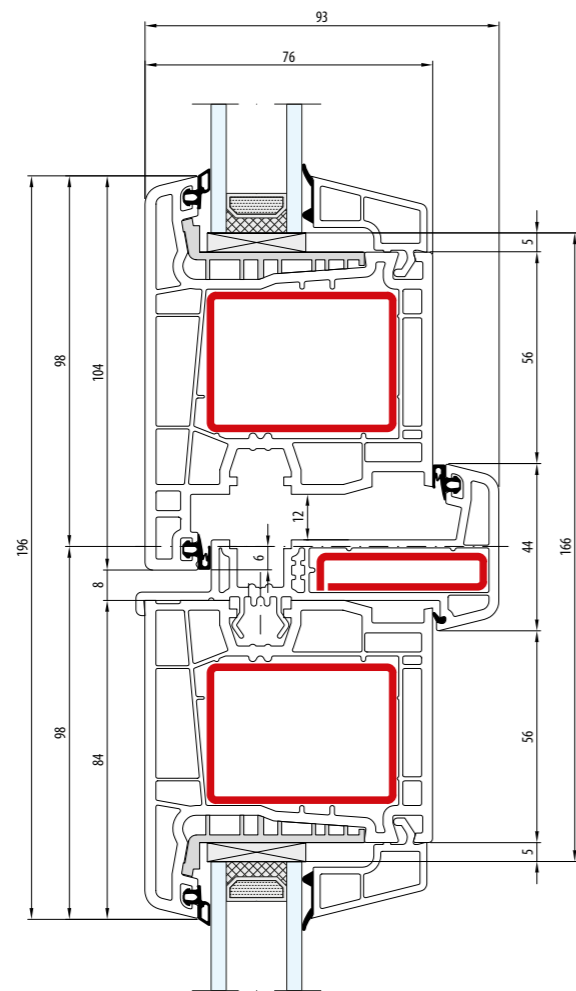

- Słupek ruchomy: 44 mm · Skrzydło: 104 mm / 84 mm
- Meneau mobile: 44 mm · Vantail: 104 mm / 84 mm
- Movable post: 44 mm · Sash: 104 mm / 84 mm
- Stulp: 44 mm · Flügel: 104 mm / 84 mm
- Montante mobile: 44 mm · Anta: 104 mm / 84 mm

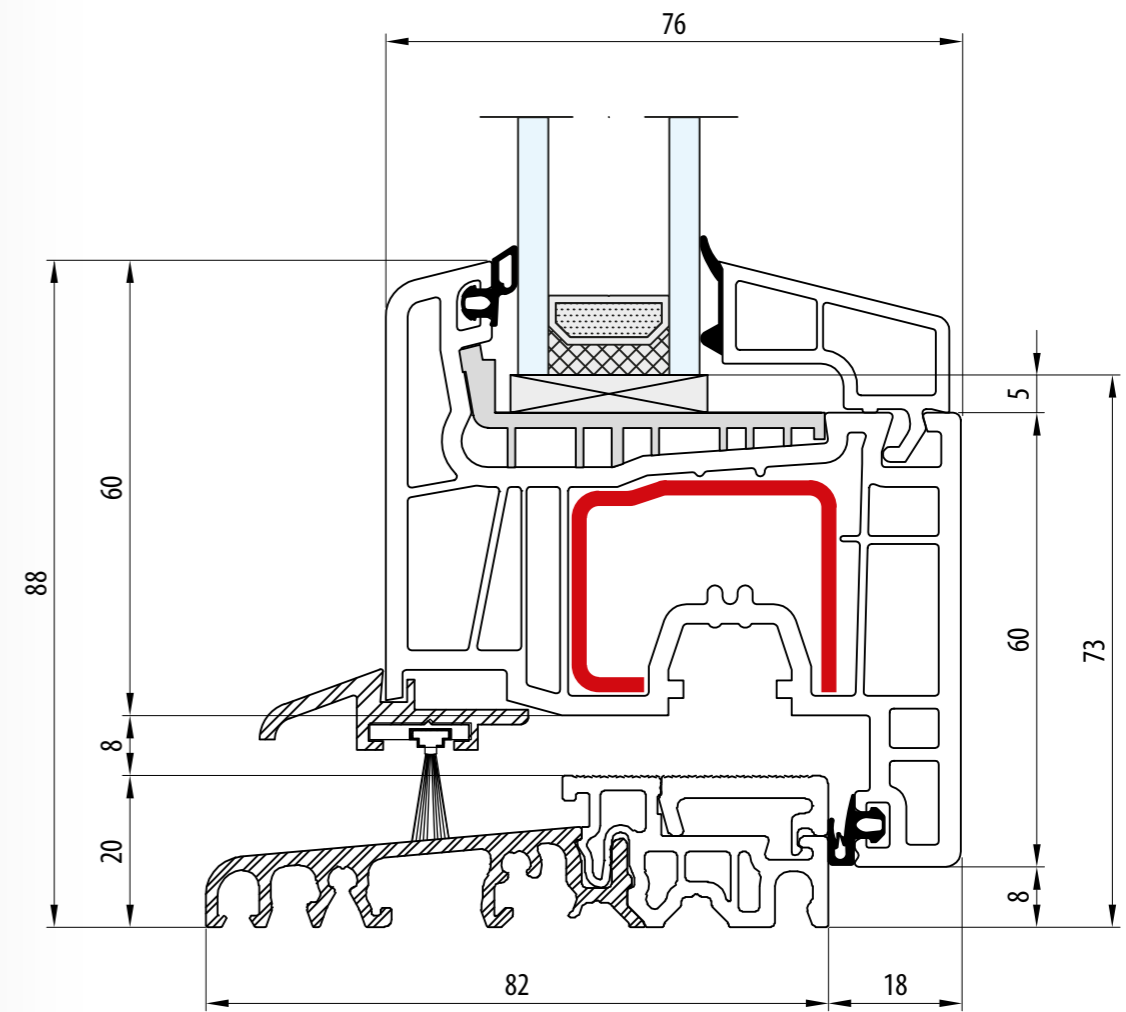
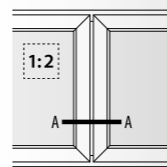

- Próg: 20 mm · Skrzydło: 80 mm
- Seuil: 20 mm · Vantail: 80 mm
- Threshold: 20 mm · Sash: 80 mm
- Schwelle: 20 mm · Flügel: 80 mm
- Soglia: 20 mm · Anta: 80 mm

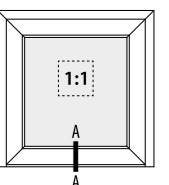



STREAMLINE 76

BLUEEVOLUTION 82

BLUEEVOLUTION 92

- Próg: 20 mm · Skrzydło: 80 mm
- Seuil: 20 mm · Vantail: 80 mm
- Threshold: 20 mm · Sash: 80 mm
- Schwelle: 20 mm · Flügel: 80 mm
- Soglia: 20 mm · Anta: 80 mm

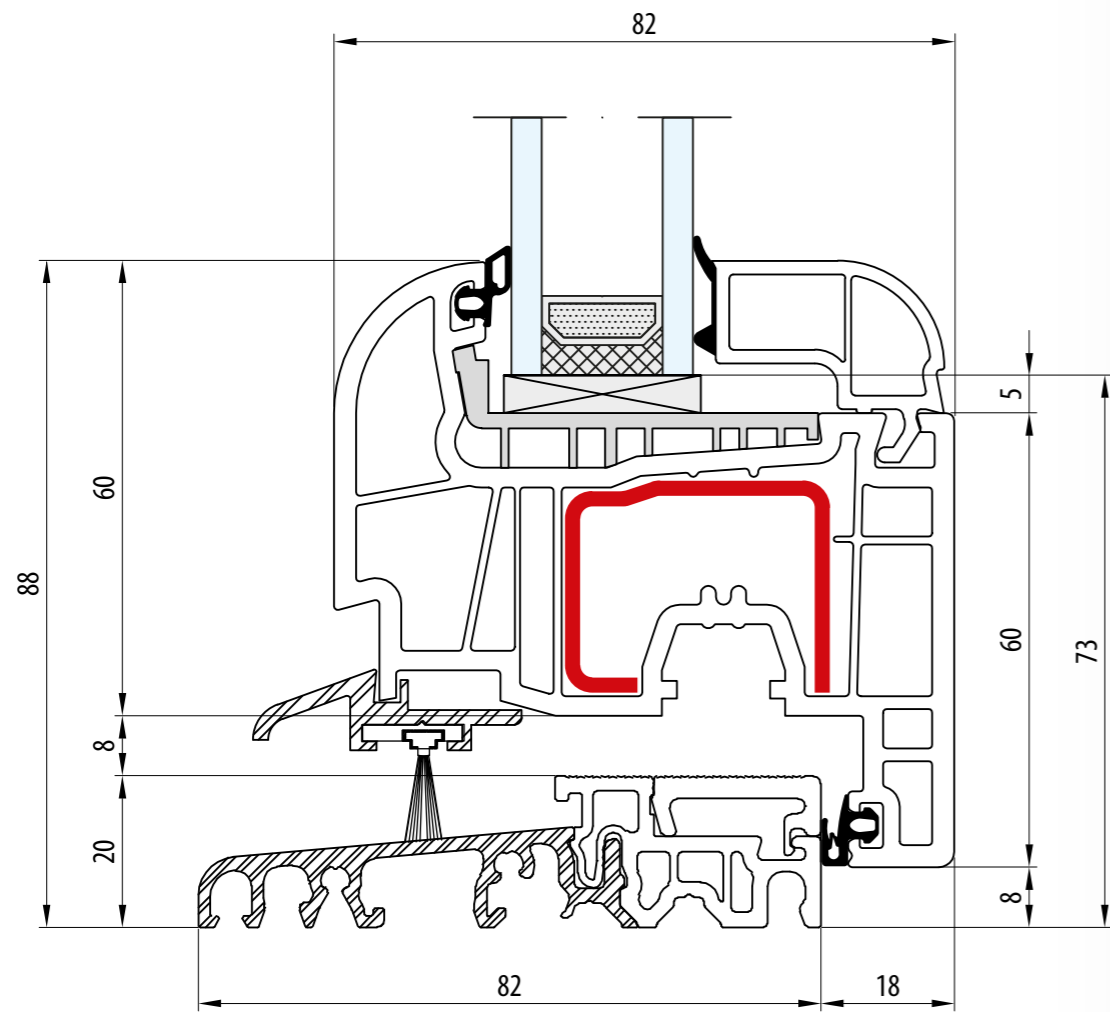
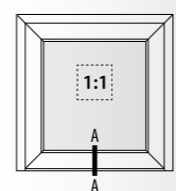

STREAMLINE 76

BLUEEVOLUTION 82

BLUEEVOLUTION 92



- Próg: 20 mm · Skrzydło: 104 mm
- Seuil: 20 mm · Vantail: 104 mm
- Threshold: 20 mm · Sash: 104 mm
- Schwelle: 20 mm · Flügel: 104 mm
- Soglia: 20 mm · Anta: 104 mm

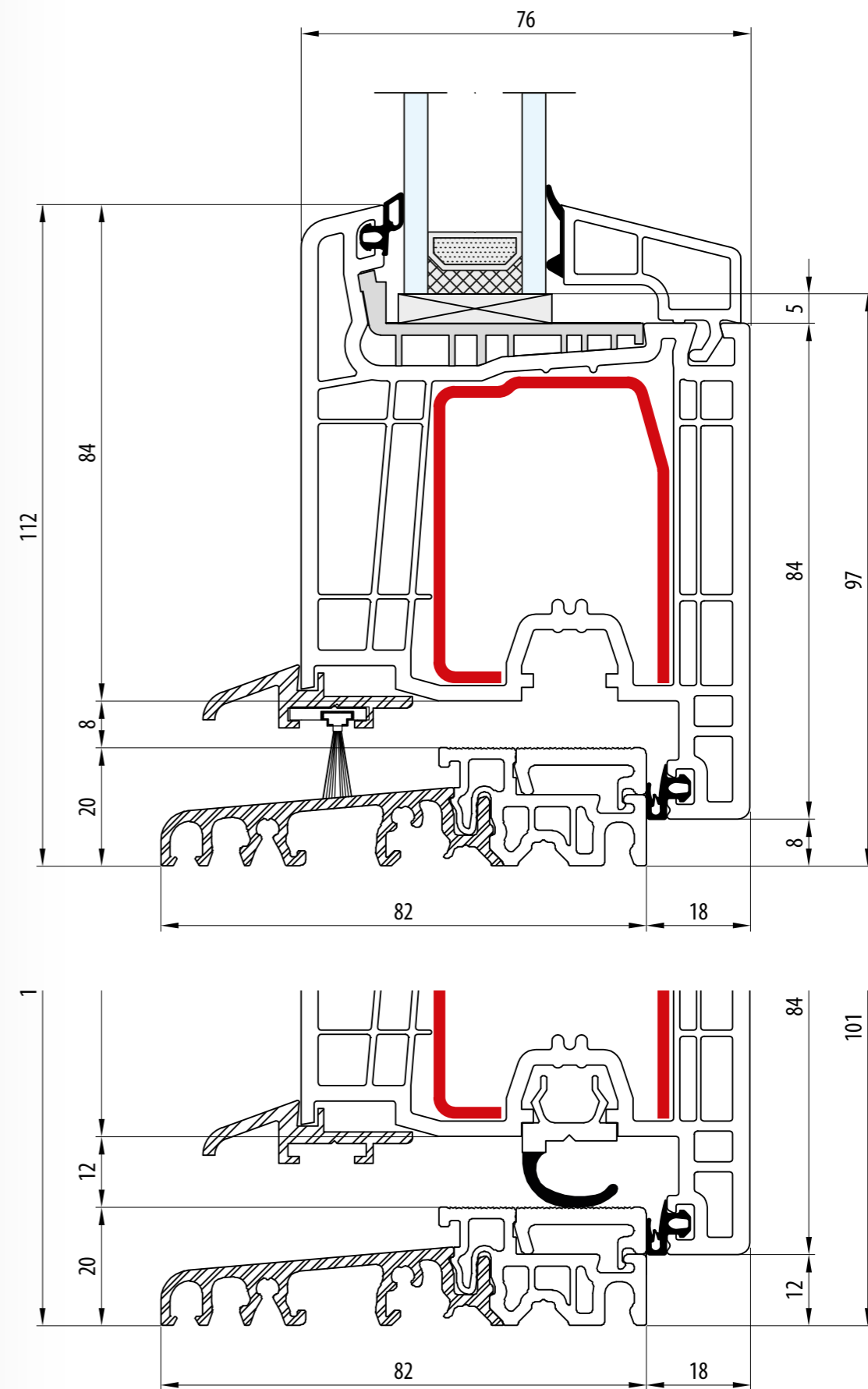
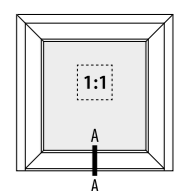

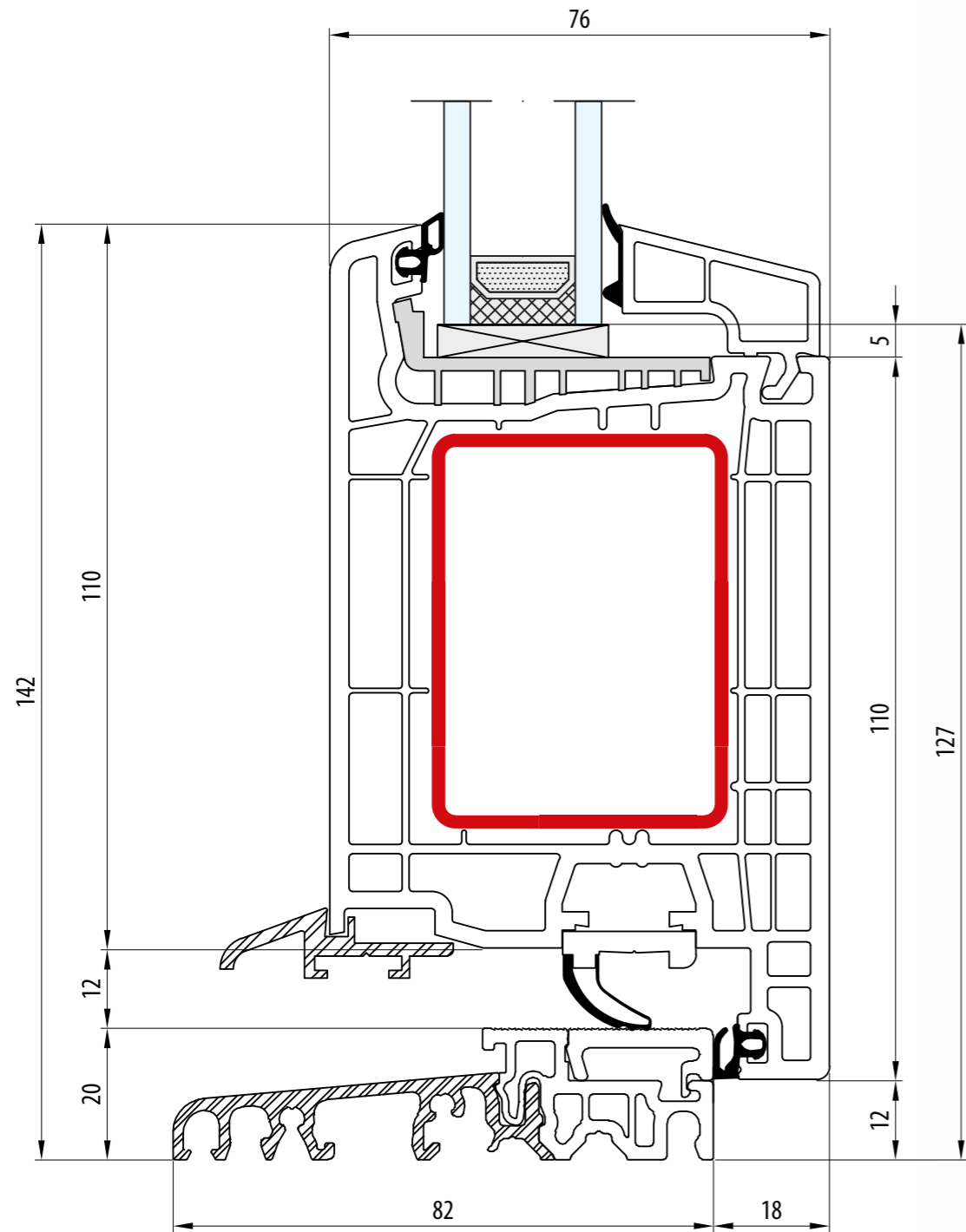

- Próg: 20 mm · Skrzydło: 130 mm
- Seuil: 20 mm · Vantail: 130 mm
- Threshold: 20 mm · Sash: 130 mm
- Schwelle: 20 mm · Flügel: 130 mm
- Soglia: 20 mm · Anta: 130 mm

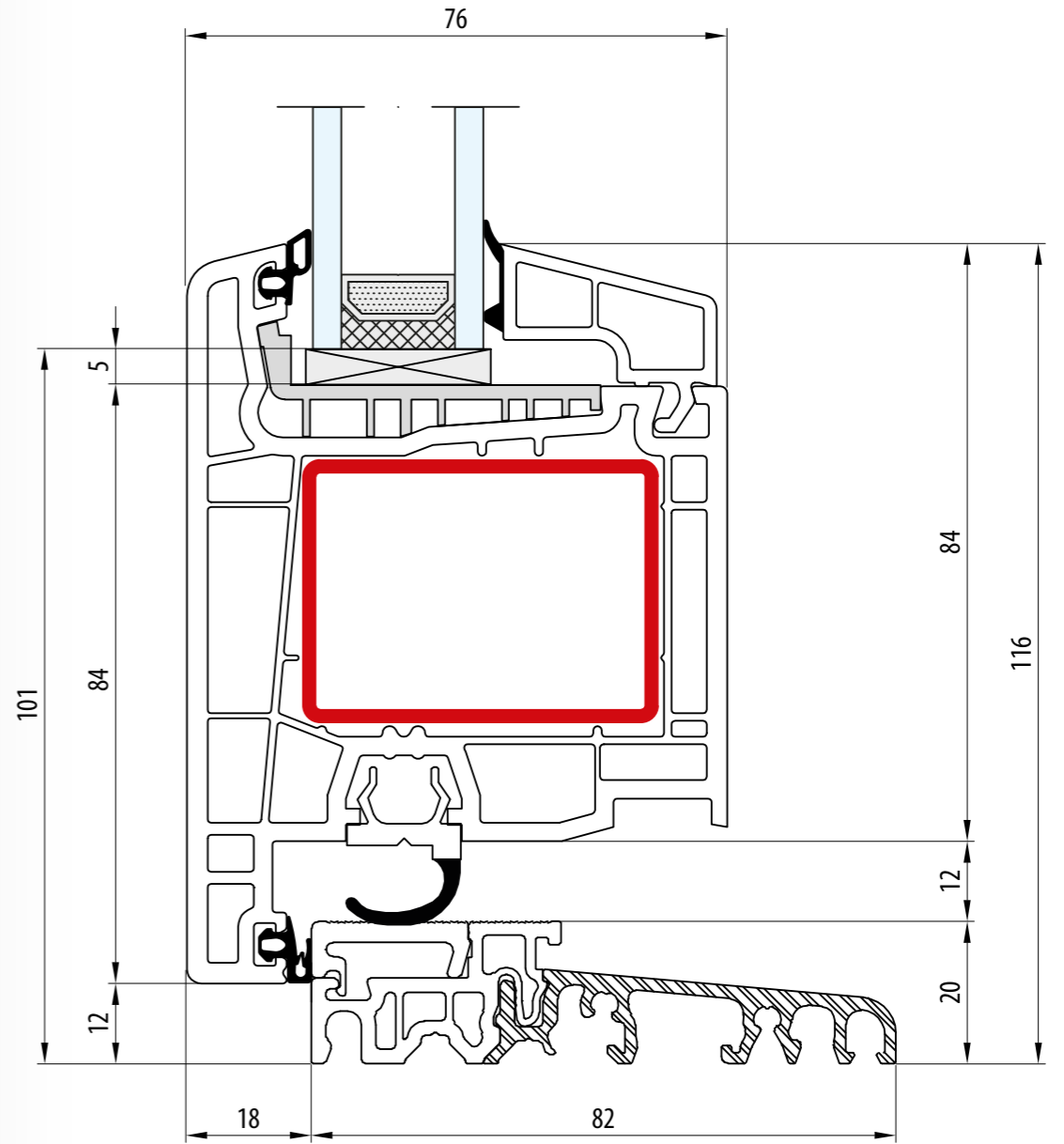
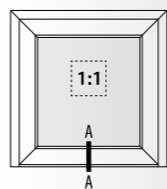

- Próg: 20 mm · Skrzydło: 104 mm
- Seuil: 20 mm · Vantail: 104 mm
- Threshold: 20 mm · Sash: 104 mm
- Schwelle: 20 mm · Flügel: 104 mm
- Soglia: 20 mm · Anta: 104 mm

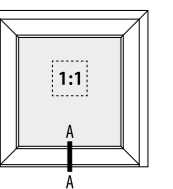

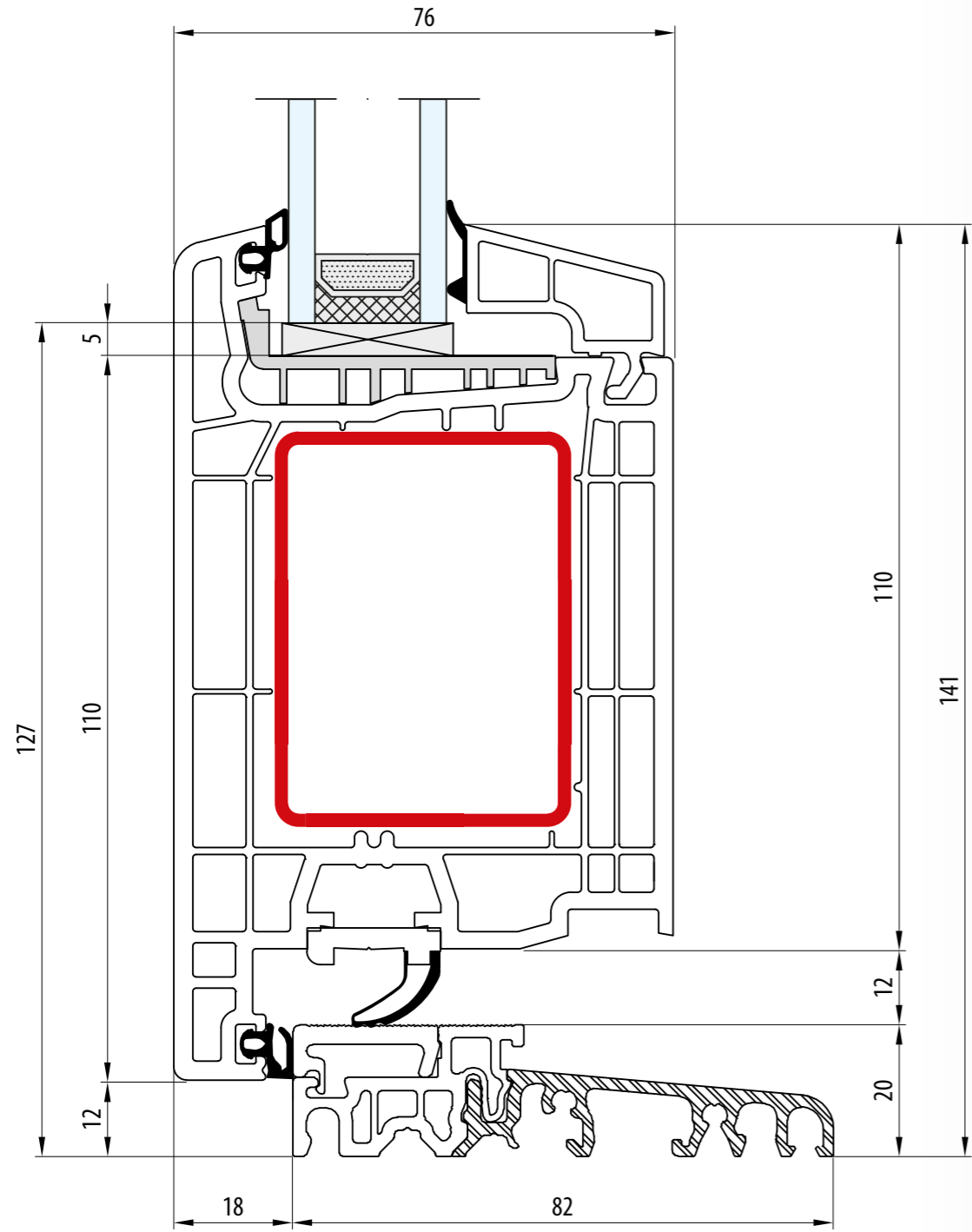

- Próg: 20 mm · Skrzydło: 130 mm
- Seuil: 20 mm · Vantail: 130 mm
- Threshold: 20 mm · Sash: 130 mm
- Schwelle: 20 mm · Flügel: 130 mm
- Soglia: 20 mm · Anta: 130 mm

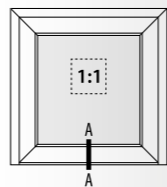

BLUEVOLUTION 82

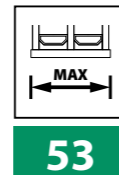
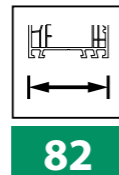
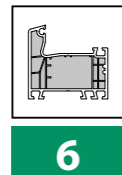

STREAMLINE 76

BLUEVOLUTION 82

BLUEVOLUTION 92

STREAMLINE 76

BLUEVOLUTION 82

BLUEVOLUTION 92

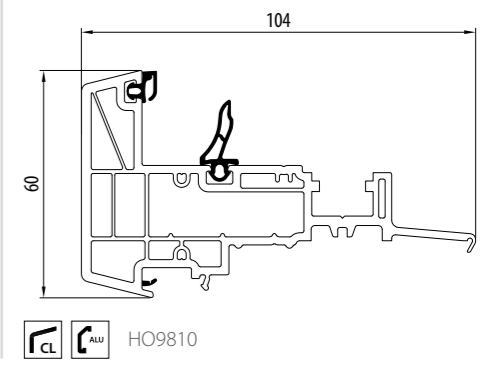
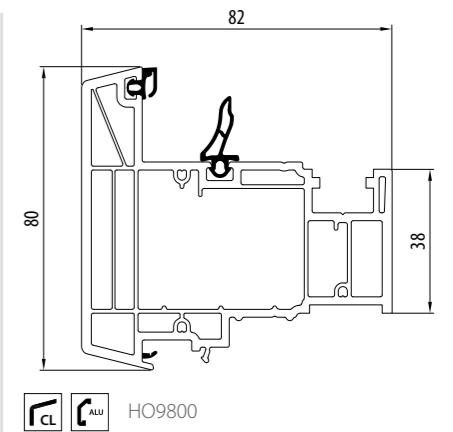
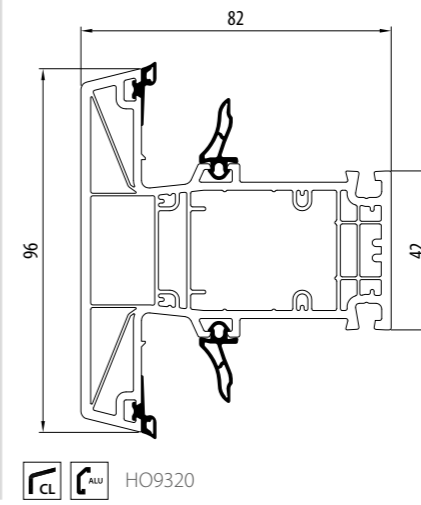
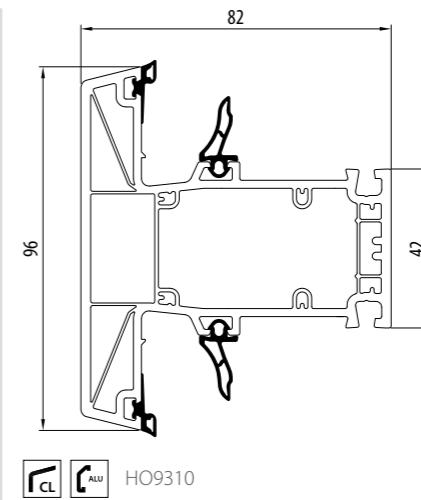
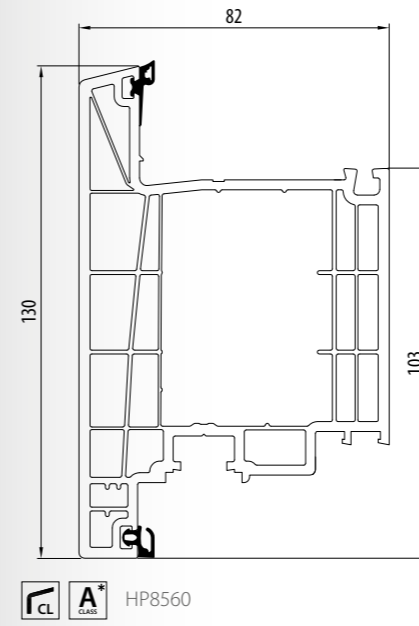
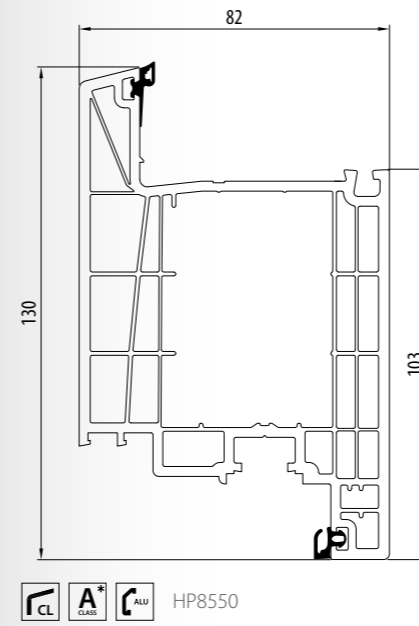
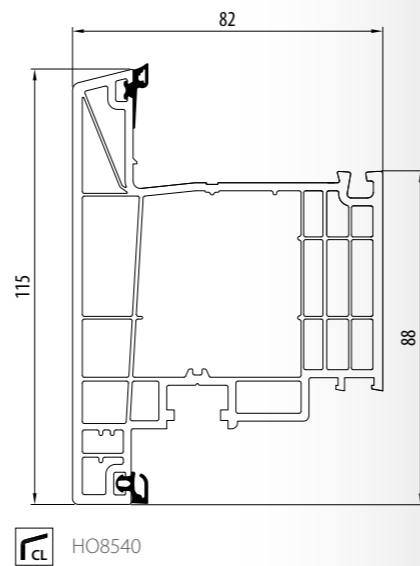
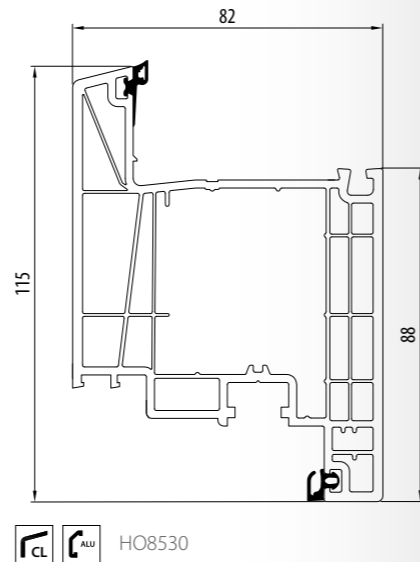
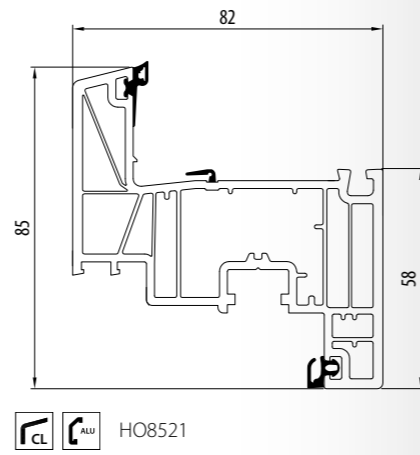
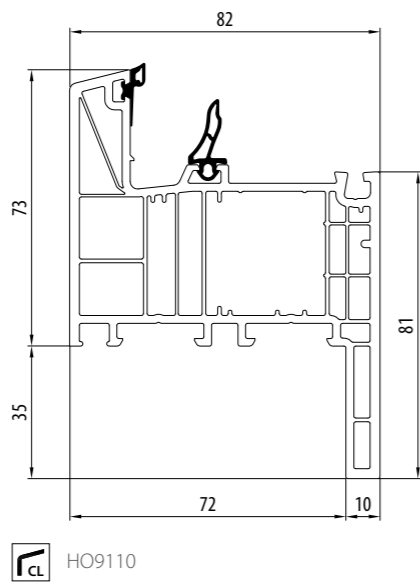
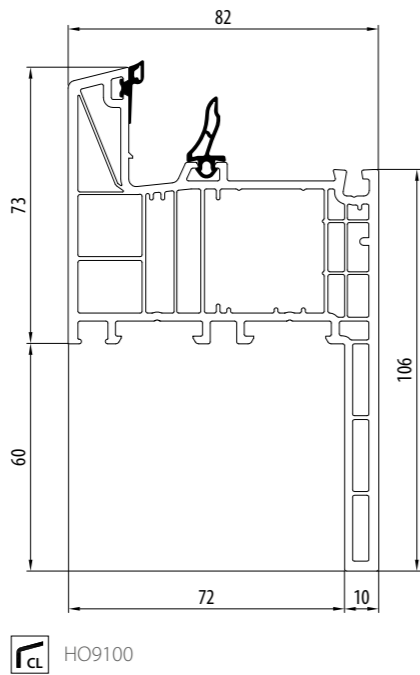
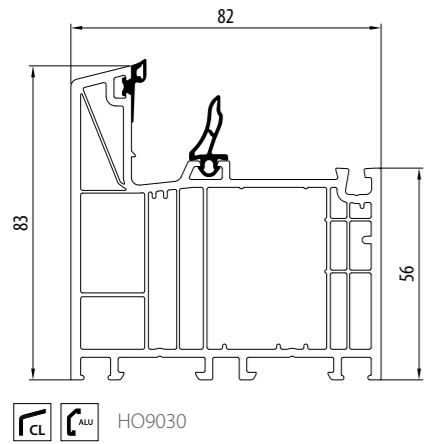
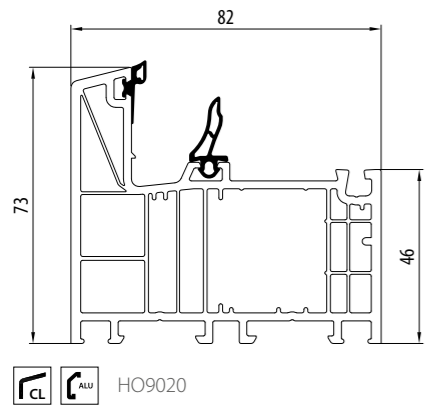

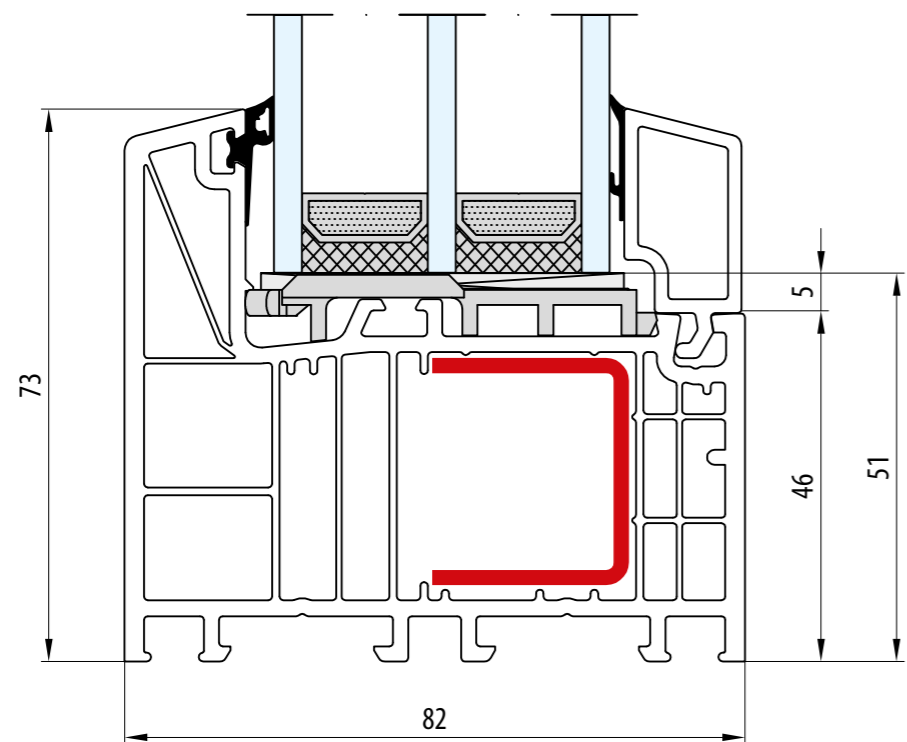

- Rama: 73 mm
- Dormant: 73 mm
- Frame: 73 mm
- Rahmen: 73 mm
- Telaio: 73 mm

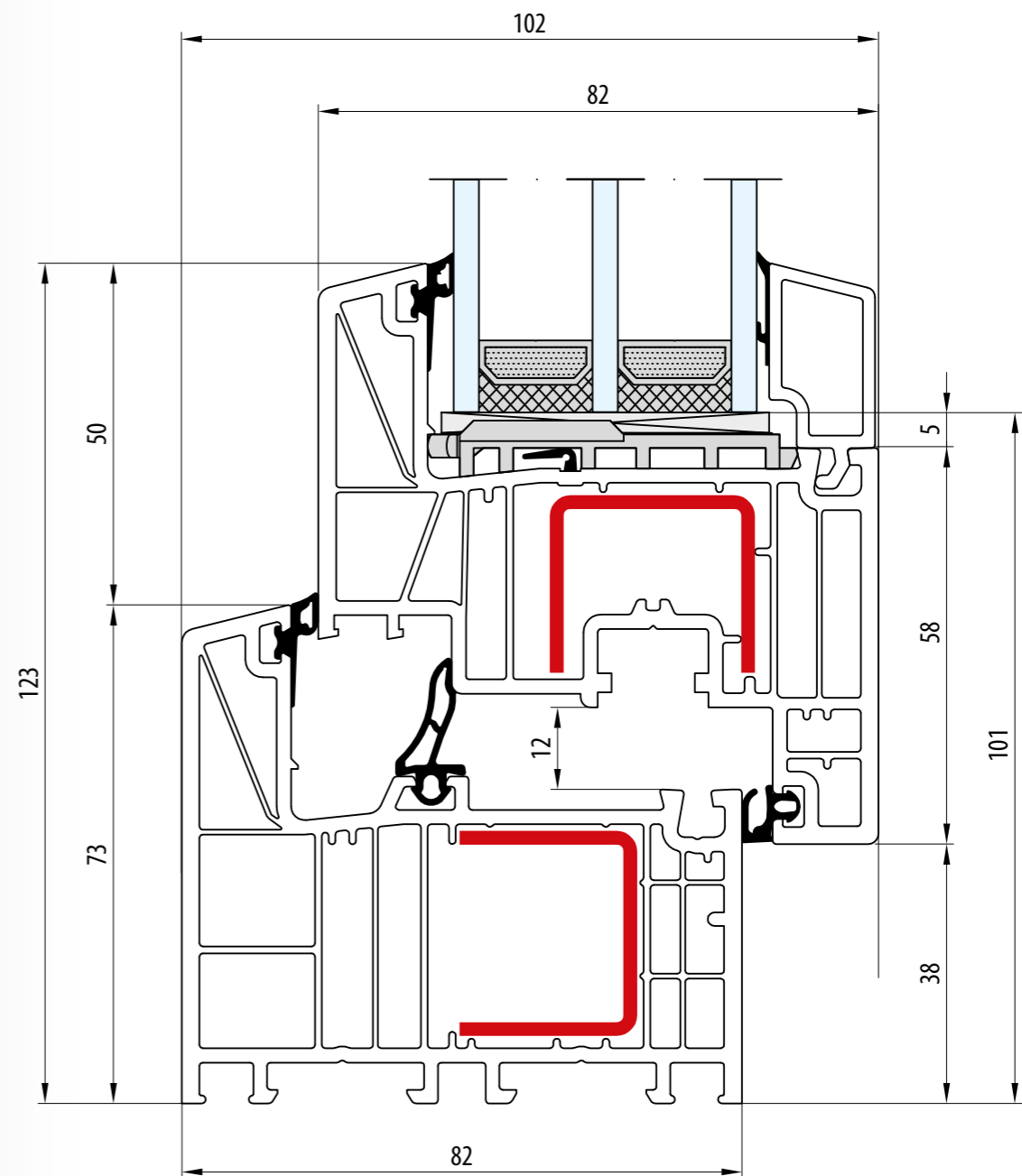
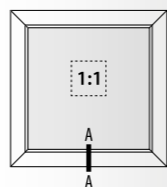

- Rama: 73 mm · Skrzydło: 85 mm
- Dormant: 73 mm · Vantail: 85 mm
- Frame: 73 mm · Sash: 85 mm
- Rahmen: 73 mm · Flügel: 85 mm
- Telaio: 73 mm · Anta: 85 mm

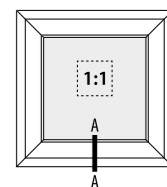

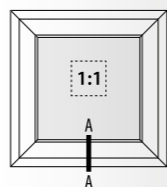
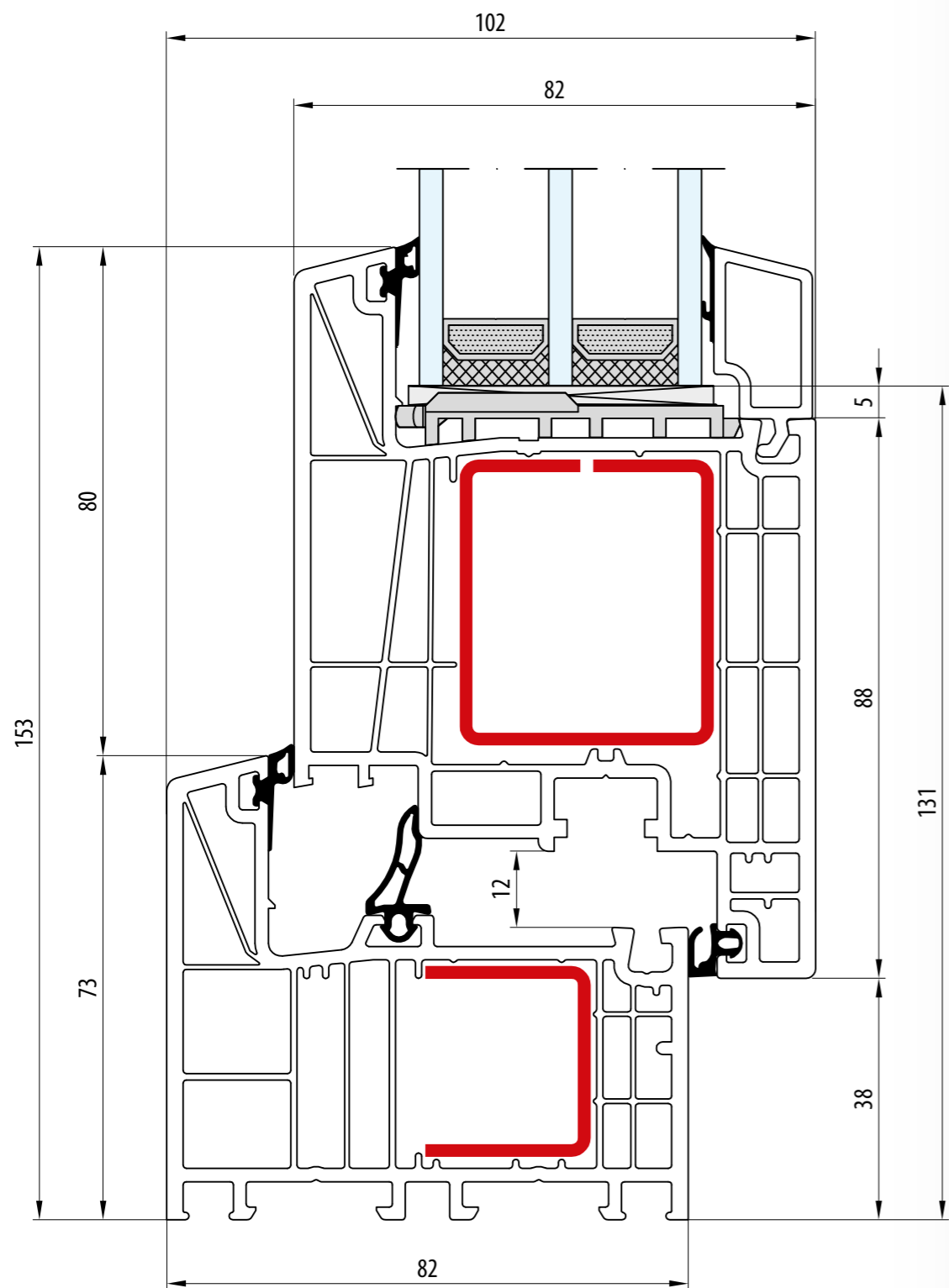

- Rama: 73 mm · Skrzydło: 115 mm
- Dormant: 73 mm · Vantail: 115 mm
- Frame: 73 mm · Sash: 115 mm
- Rahmen: 73 mm · Flügel: 115 mm
- Telaio: 73 mm · Anta: 115 mm

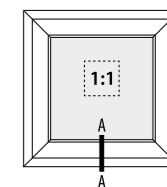
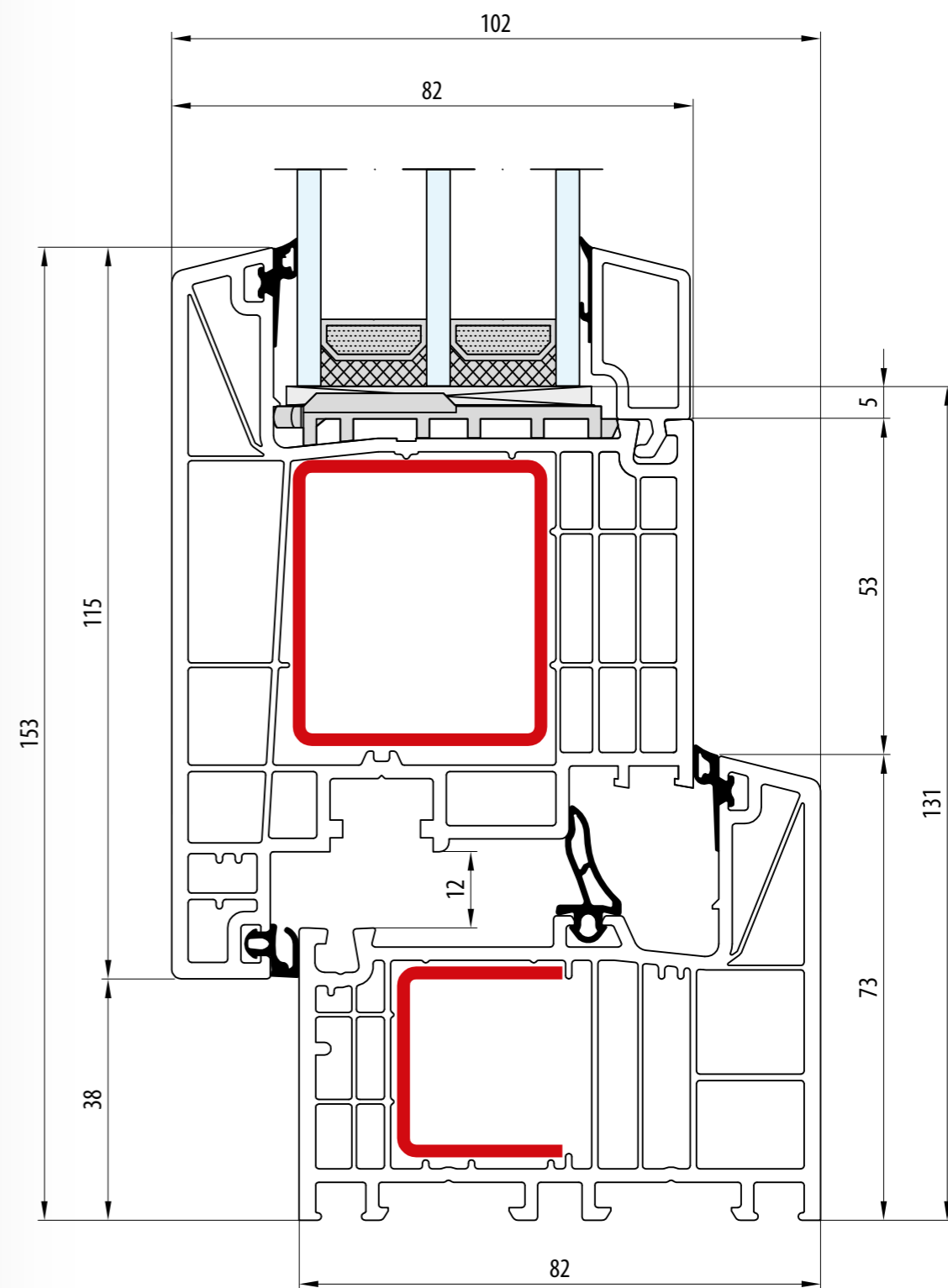

- Rama: 73 mm · Skrzydło: 115 mm
- Dormant: 73 mm · Vantail: 115 mm
- Frame: 73 mm · Sash: 115 mm
- Rahmen: 73 mm · Flügel: 115 mm
- Telaio: 73 mm · Anta: 115 mm

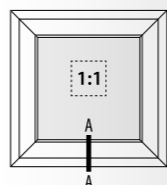
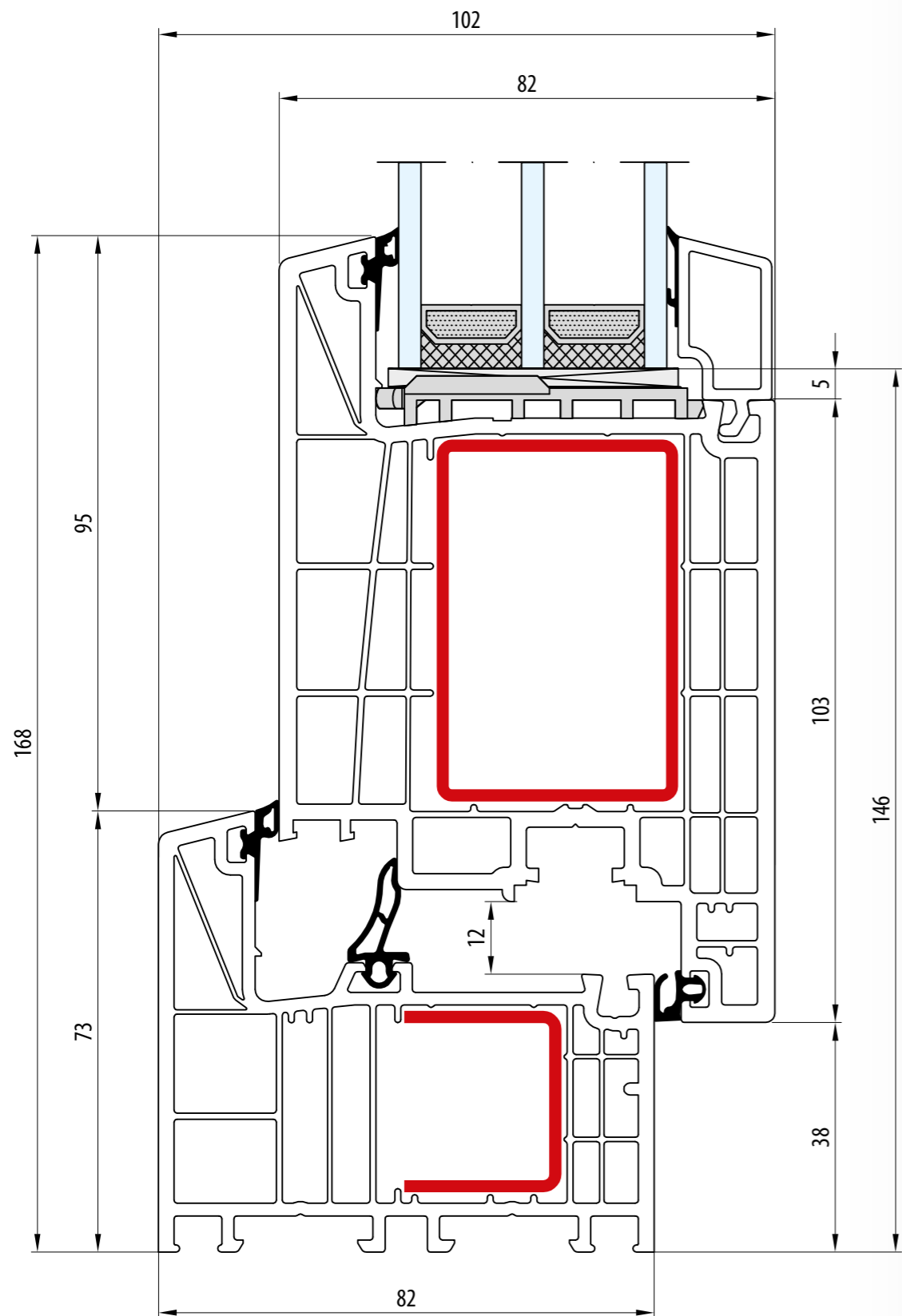

- Rama: 73 mm · Skrzydło: 130 mm
- Dormant: 73 mm · Vantail: 130 mm
- Frame: 73 mm · Sash: 130 mm
- Rahmen: 73 mm · Flügel: 130 mm
- Telaio: 73 mm · Anta: 130 mm

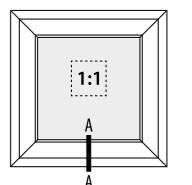
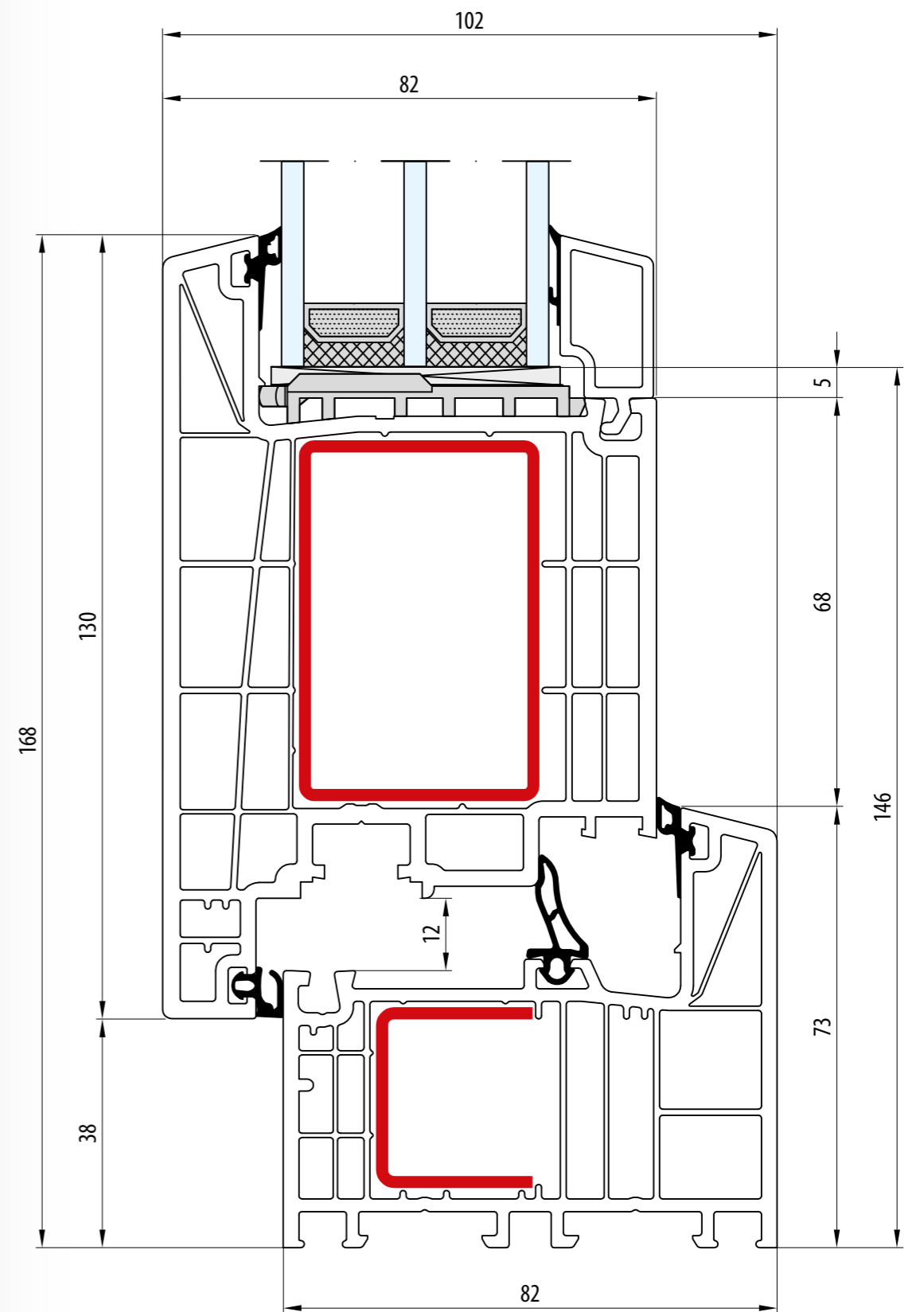

- Rama: 73 mm · Skrzydło: 130 mm
- Dormant: 73 mm · Vantail: 130 mm
- Frame: 73 mm · Sash: 130 mm
- Rahmen: 73 mm · Flügel: 130 mm
- Telaio: 73 mm · Anta: 130 mm

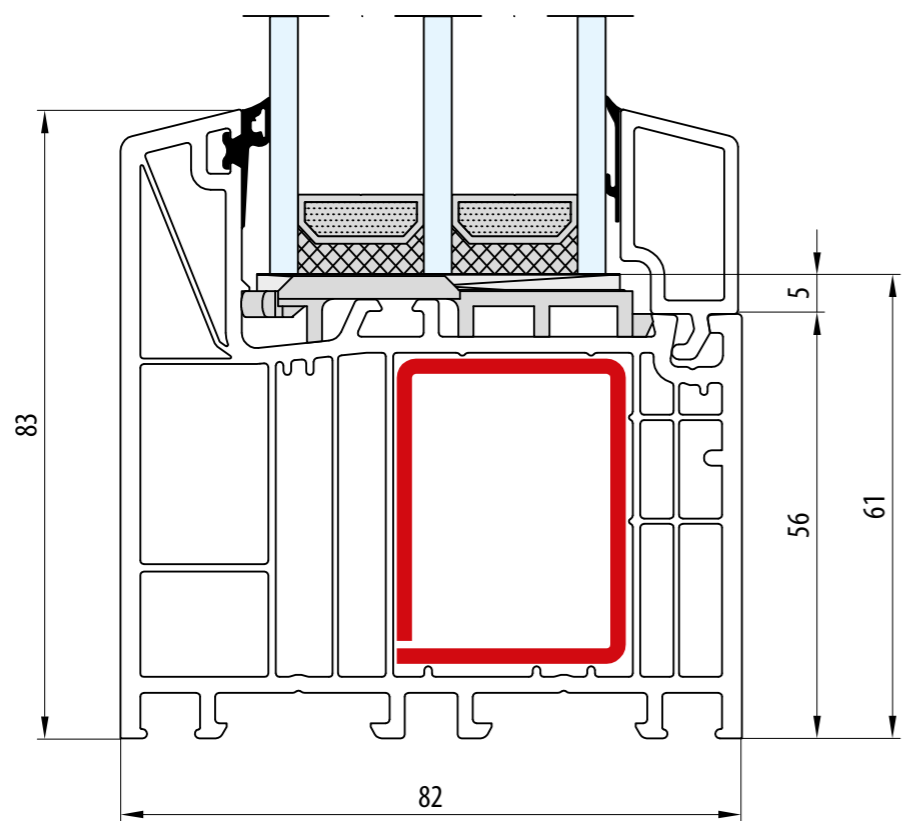

- Rama: 83 mm
- Dormant: 83 mm
- Frame: 83 mm
- Rahmen: 83 mm
- Telaio: 83 mm

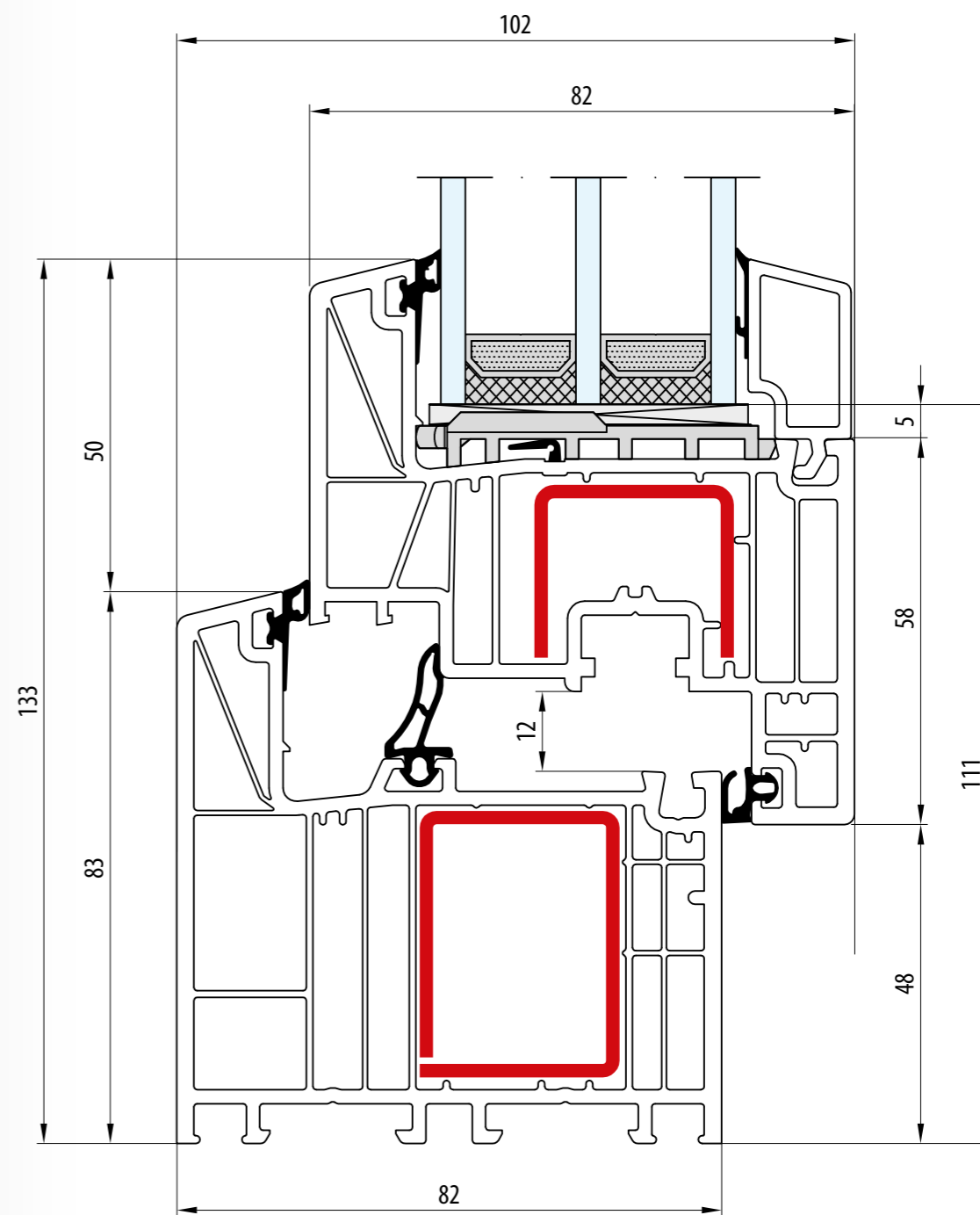
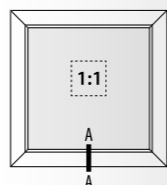

- Rama: 83 mm · Skrzydło: 85 mm
- Dormant: 83 mm · Vantail: 85 mm
- Frame: 83 mm · Sash: 85 mm
- Rahmen: 83 mm · Flügel: 85 mm
- Telaio: 83 mm · Anta: 85 mm

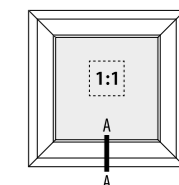

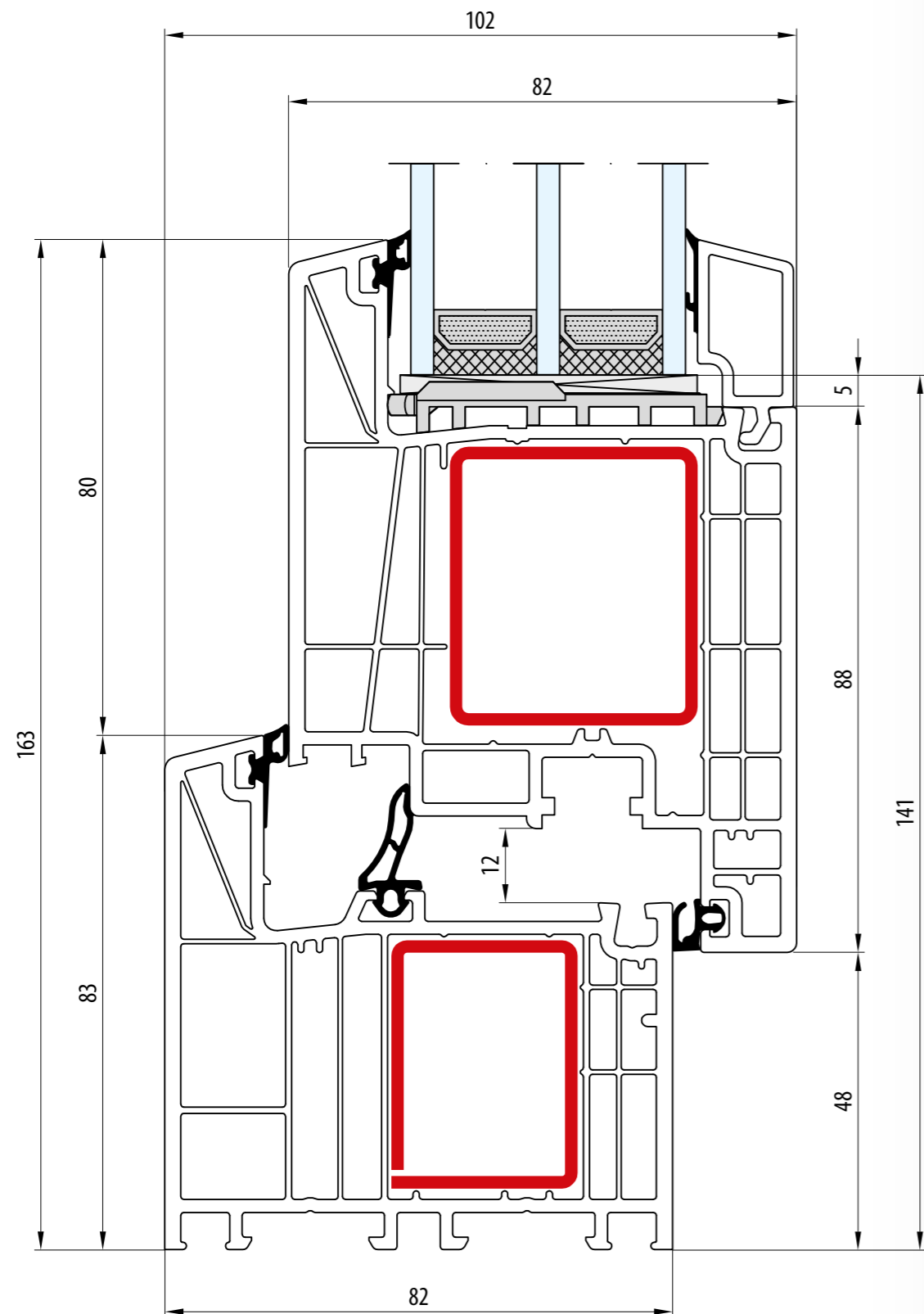

- Rama: 83 mm · Skrzydło: 115 mm
- Dormant: 83 mm · Vantail: 115 mm
- Frame: 83 mm · Sash: 115 mm
- Rahmen: 83 mm · Flügel: 115 mm
- Telaio: 83 mm · Anta: 115 mm

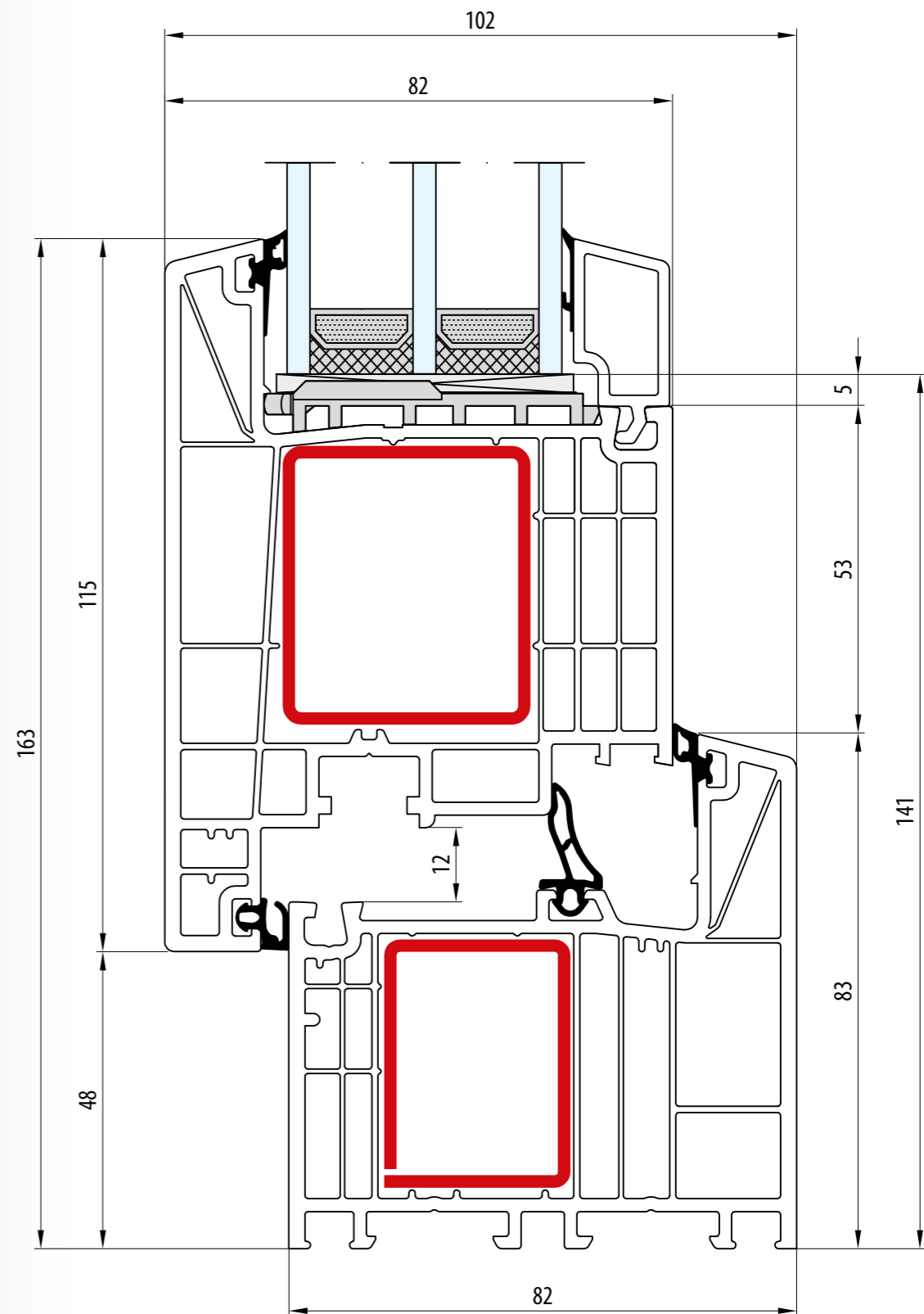
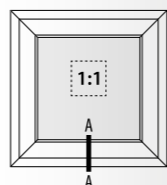

- Rama: 83 mm · Skrzydło: 115 mm
- Dormant: 83 mm · Vantail: 115 mm
- Frame: 83 mm · Sash: 115 mm
- Rahmen: 83 mm · Flügel: 115 mm
- Telaio: 83 mm · Anta: 115 mm

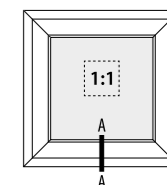

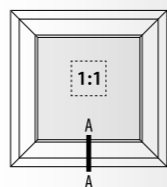
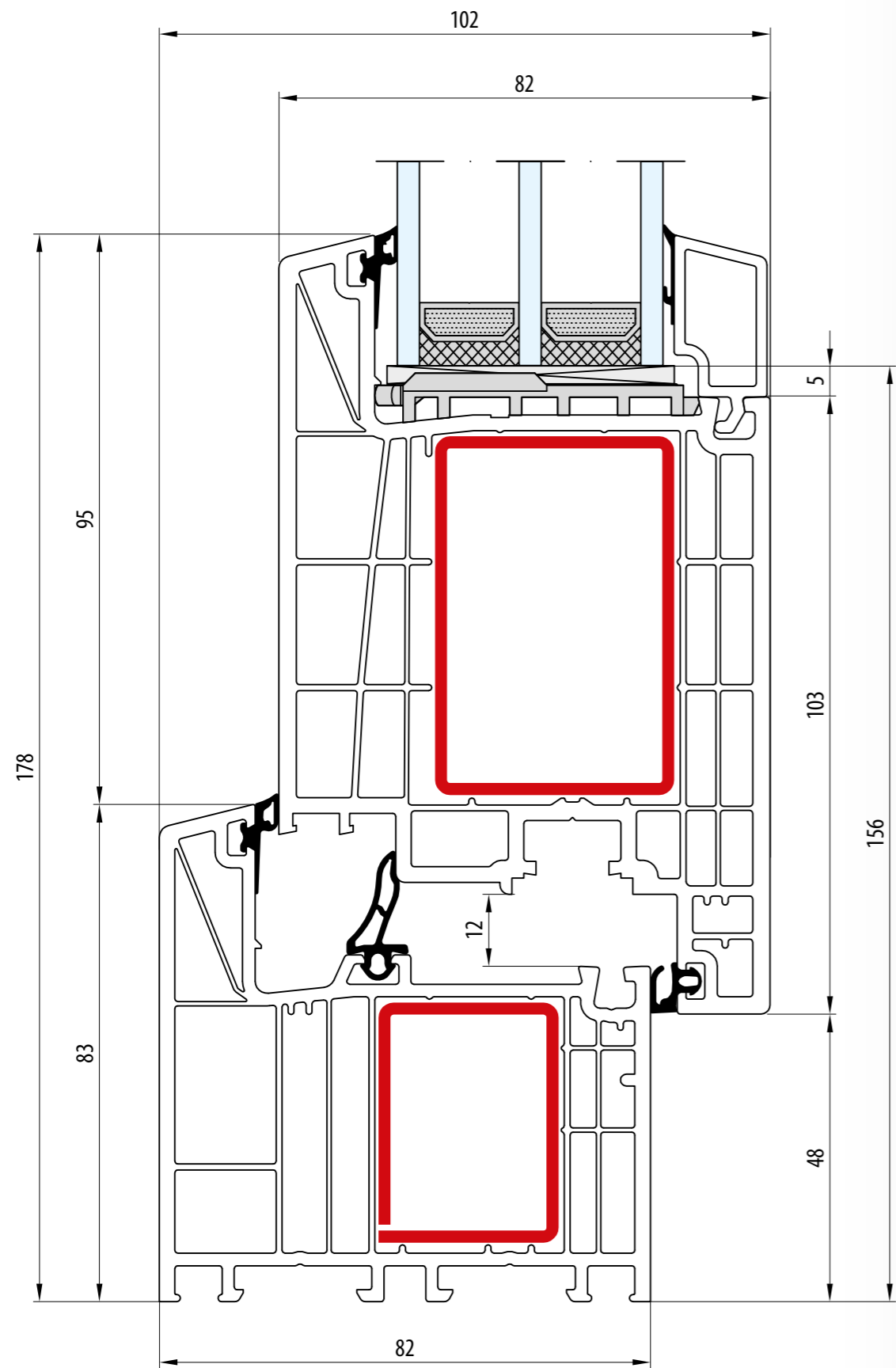

- Rama: 83 mm · Skrzydło: 130 mm
- Dormant: 83 mm · Vantail: 130 mm
- Frame: 83 mm · Sash: 130 mm
- Rahmen: 83 mm · Flügel: 130 mm
- Telaio: 83 mm · Anta: 130 mm

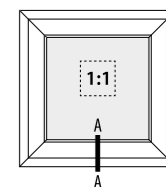
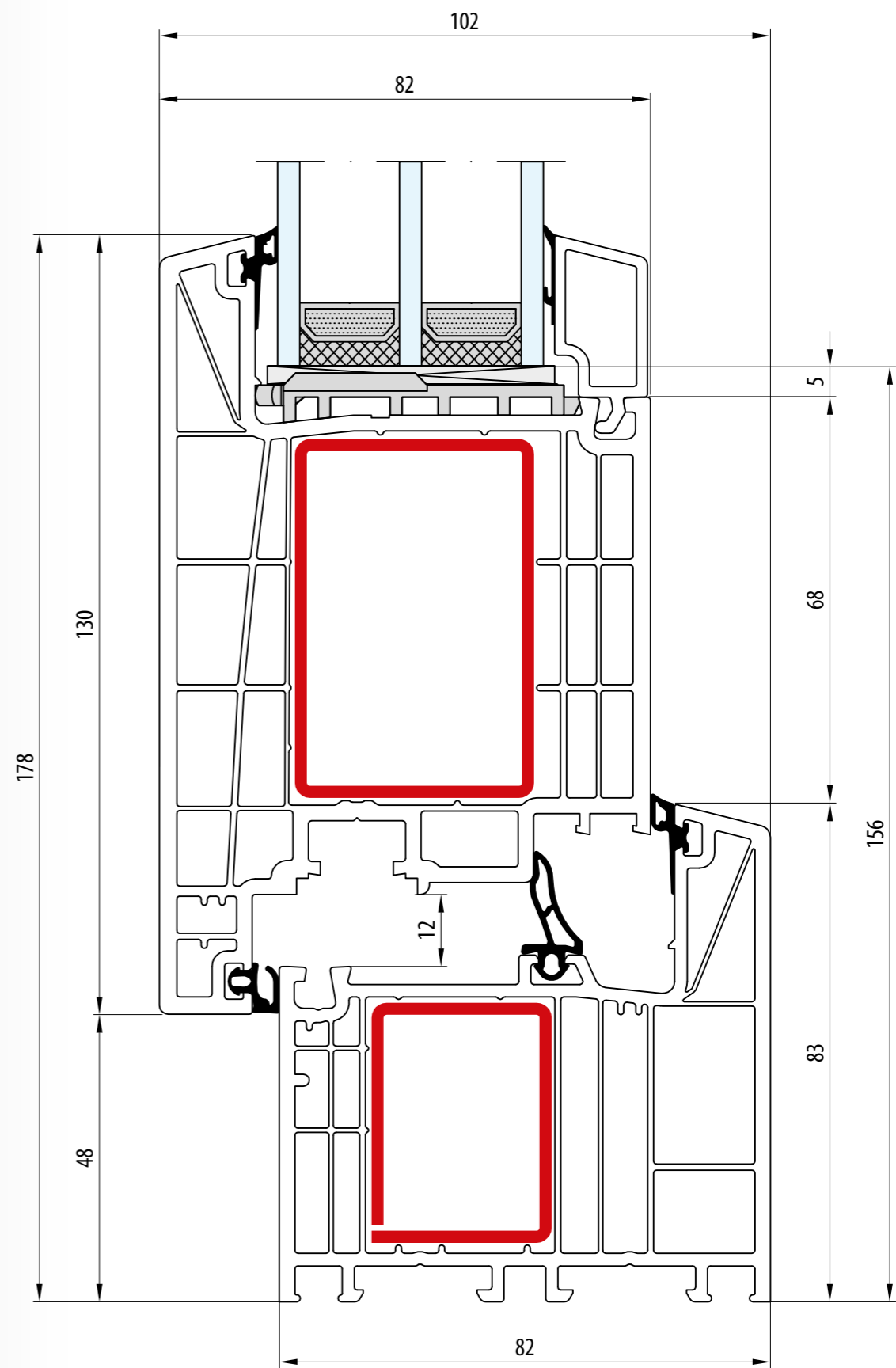

- Rama: 83 mm · Skrzydło: 130 mm
- Dormant: 83 mm · Vantail: 130 mm
- Frame: 83 mm · Sash: 130 mm
- Rahmen: 83 mm · Flügel: 130 mm
- Telaio: 83 mm · Anta: 130 mm

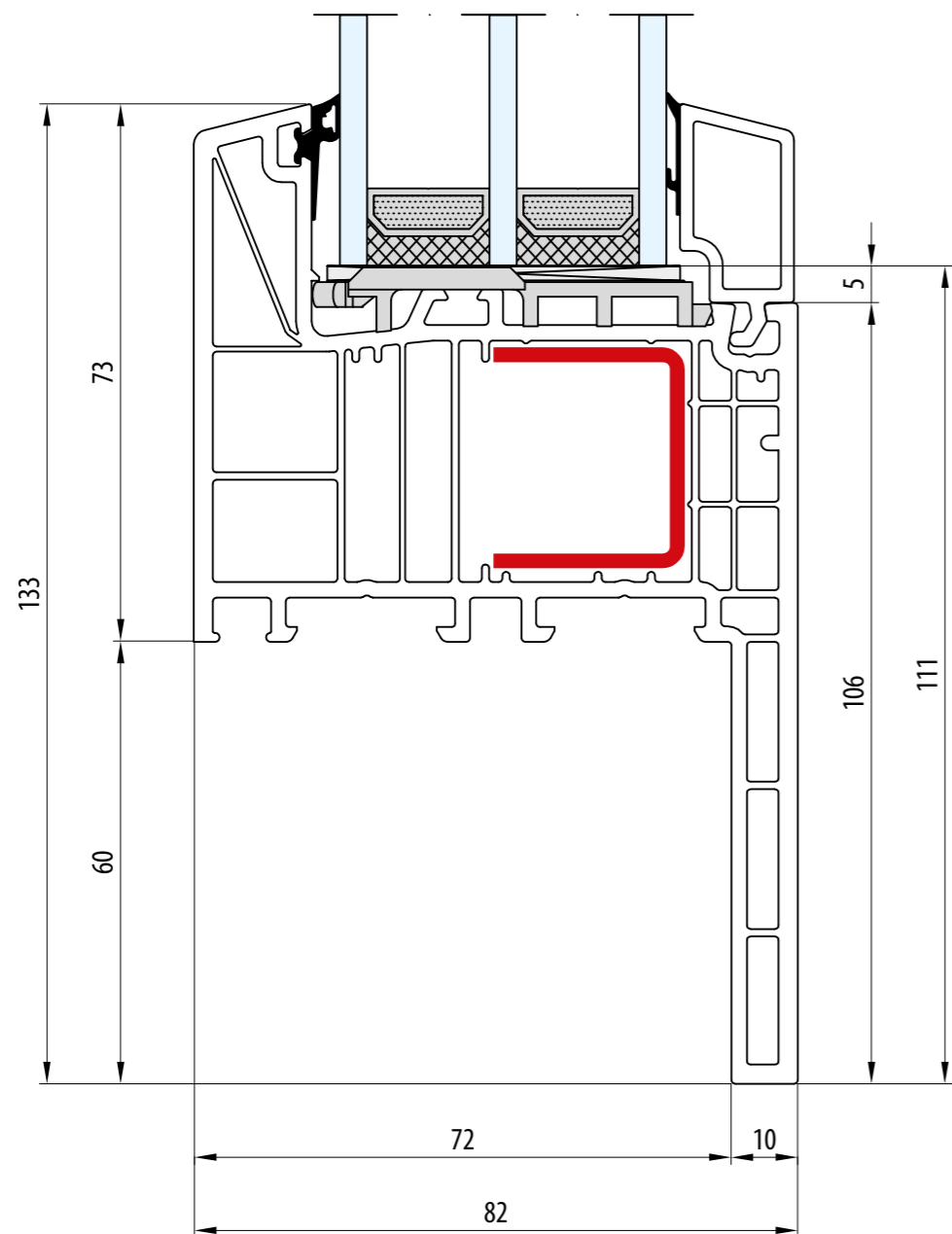

- RENOWACJA - Pletwa: 60 mm · Rama: 73 mm
- RÉNOVATION - Lip: 60 mm · Dormant: 73 mm
- RENOVATION - Strip: 60 mm · Frame: 73 mm
- RENOVIERUNG - Flosse: 60 mm · Rahmen: 73 mm
- RINNOVAZIONE - Aletta da: 60 mm · Telaio: 73 mm

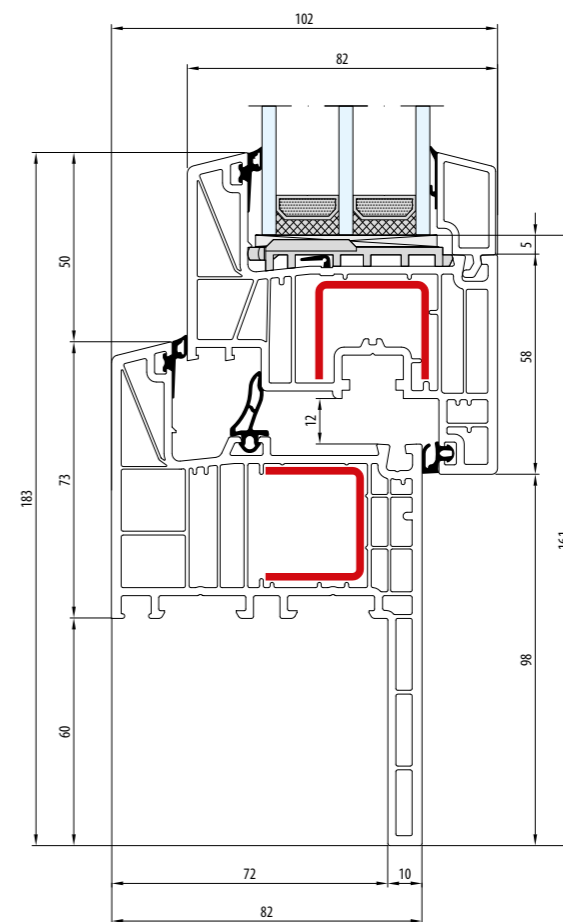
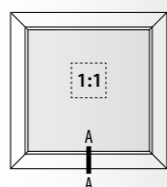

- RENOWACJA - Pletwa: 60 mm · Rama: 73 mm · Skrzydło: 85 mm
- RÉNOVATION - Lip: 60 mm · Dormant: 73 mm · Vantail: 85 mm
- RENOVATION - Strip: 60 mm · Frame: 73 mm · Sash: 85 mm
- RENOVIERUNG - Flosse: 60 mm · Rahmen: 73 mm · Flügel: 85 mm
- RINNOVAZIONE - Aletta da: 60 mm · Telaio: 73 mm · Anta: 85 mm

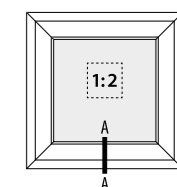

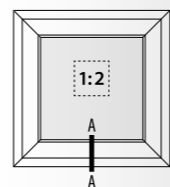
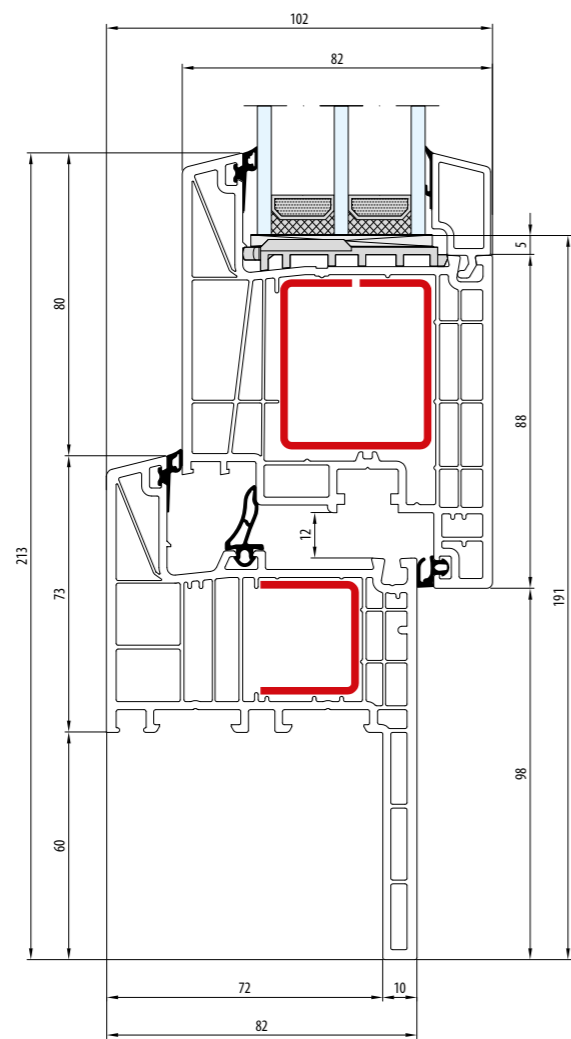

- RENOWACJA - Pletwa: 60 mm · Rama: 73 mm · Skrzydło: 115 mm
- RÉNOVATION - Lip: 60 mm · Dormant: 73 mm · Vantail: 115 mm
- RENOVATION - Strip: 60 mm · Frame: 73 mm · Sash: 115 mm
- RENOVIERUNG - Flosse: 60 mm · Rahmen: 73 mm · Flügel: 115 mm
- RINNOVAZIONE - Aletta da: 60 mm · Telaio: 73 mm · Anta: 115 mm

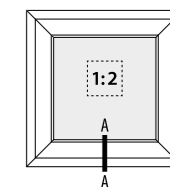
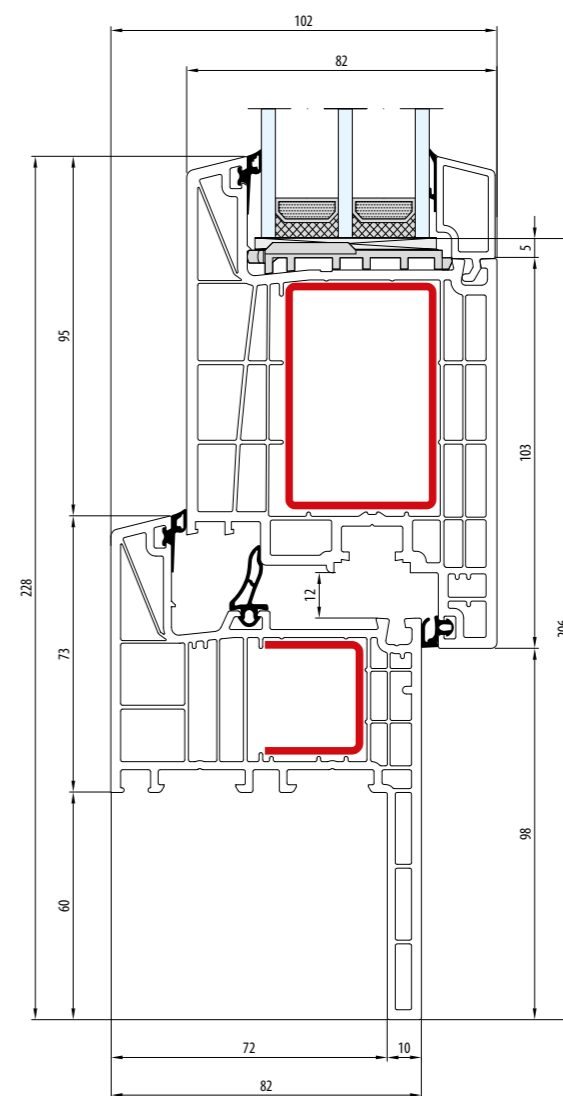

- RENOWACJA - Pletwa: 60 mm · Rama: 73 mm · Skrzydło: 130 mm
- RÉNOVATION - Lip: 60 mm · Dormant: 73 mm · Vantail: 130 mm
- RENOVATION - Strip: 60 mm · Frame: 73 mm · Sash: 130 mm
- RENOVIERUNG - Flosse: 60 mm · Rahmen: 73 mm · Flügel: 130 mm
- RINNOVAZIONE - Aletta da: 60 mm · Telaio: 73 mm · Anta: 130 mm

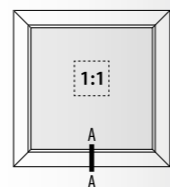
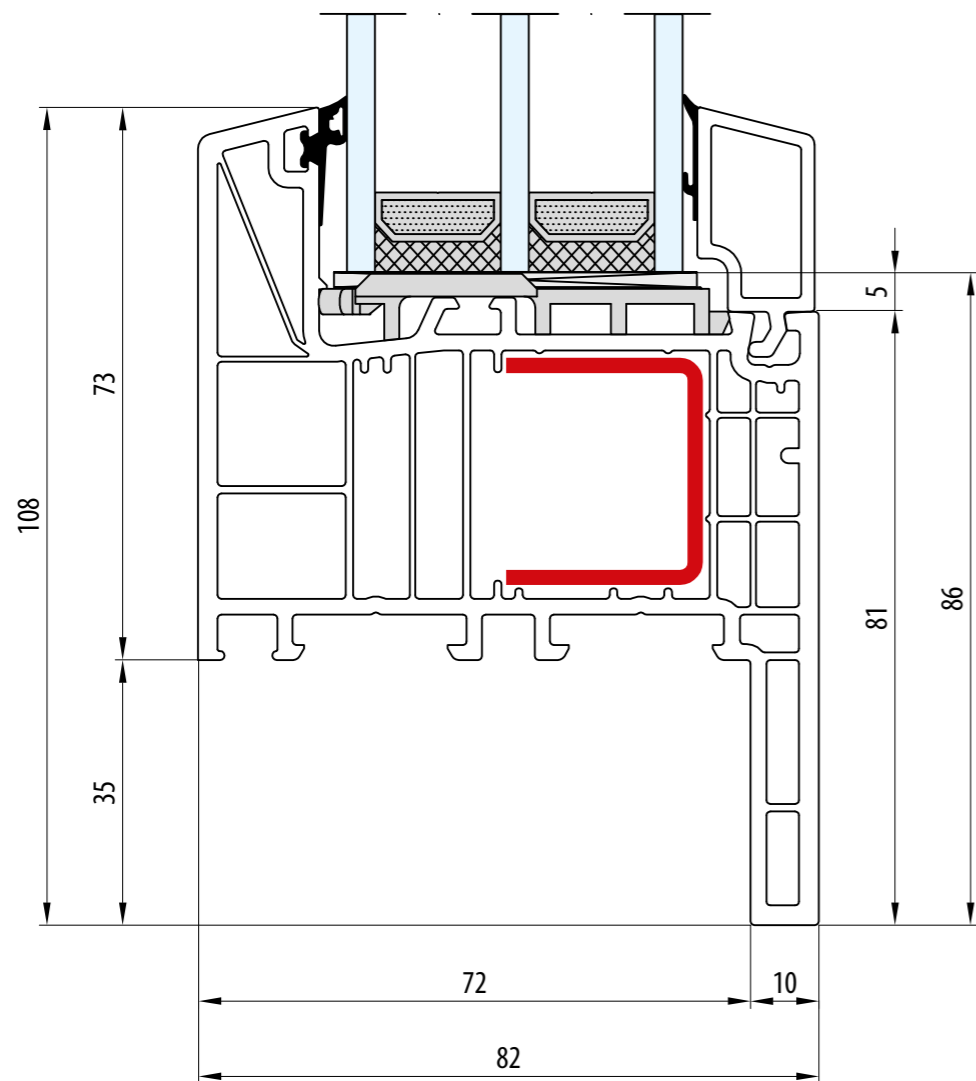

- RENOWACJA - Pletwa: 35 mm · Rama: 73 mm
- RÉNOVATION - Lip: 35 mm · Dormant: 73 mm
- RENOVATION - Strip: 35 mm · Frame: 73 mm
- RENOVIERUNG - Flosse: 35 mm · Rahmen: 73 mm
- RINNOVAZIONE - Aletta da: 35 mm · Telaio: 73 mm

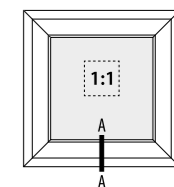
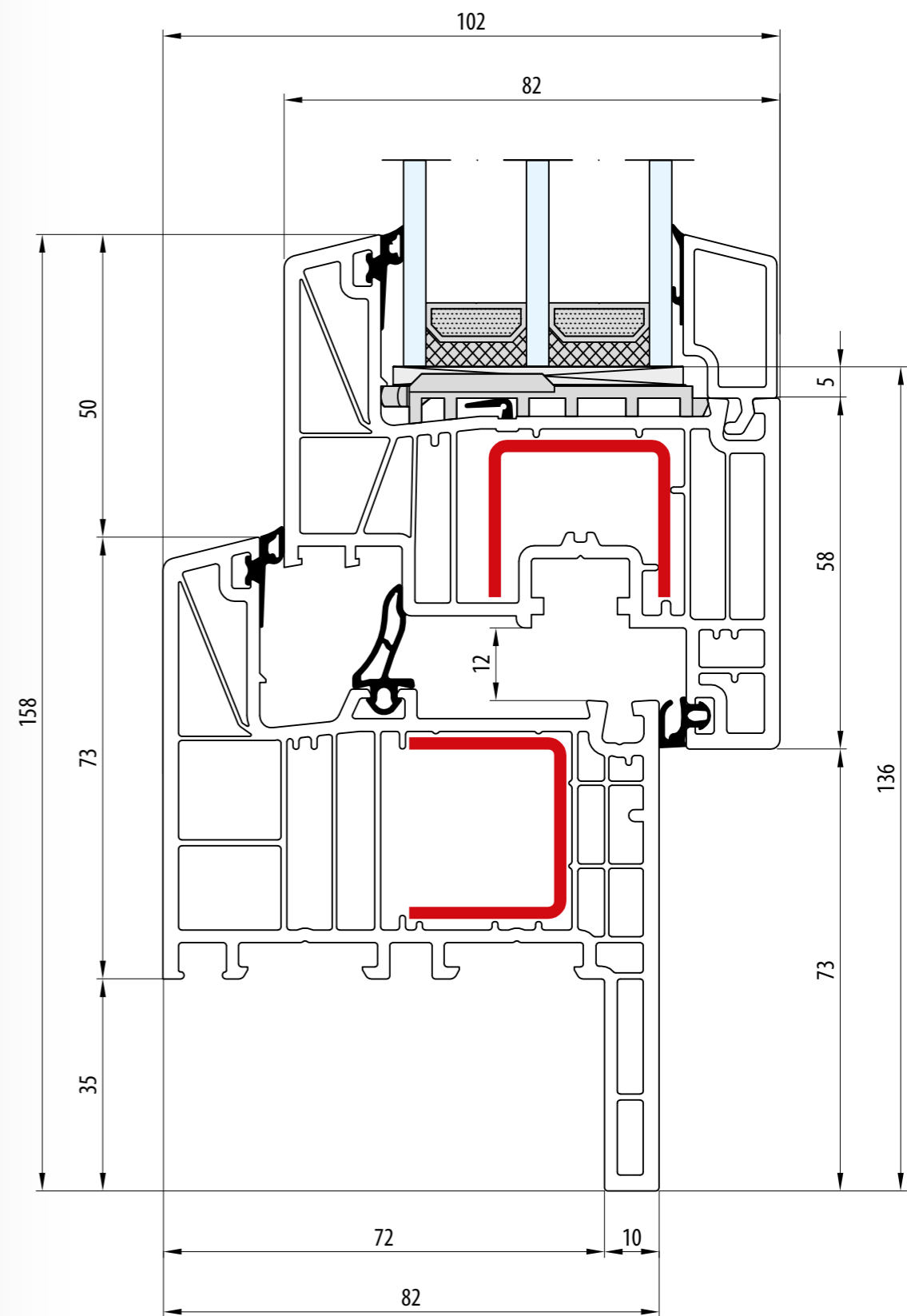

- RENOWACJA - Pletwa: 35 mm · Rama: 73 mm · Skrzydło: 85 mm
- RÉNOVATION - Lip: 35 mm · Dormant: 73 mm · Vantail: 85 mm
- RENOVATION - Strip: 35 mm · Frame: 73 mm · Sash: 85 mm
- RENOVIERUNG - Flosse: 35 mm · Rahmen: 73 mm · Flügel: 85 mm
- RINNOVAZIONE - Aletta da: 35 mm · Telaio: 73 mm · Anta: 85 mm

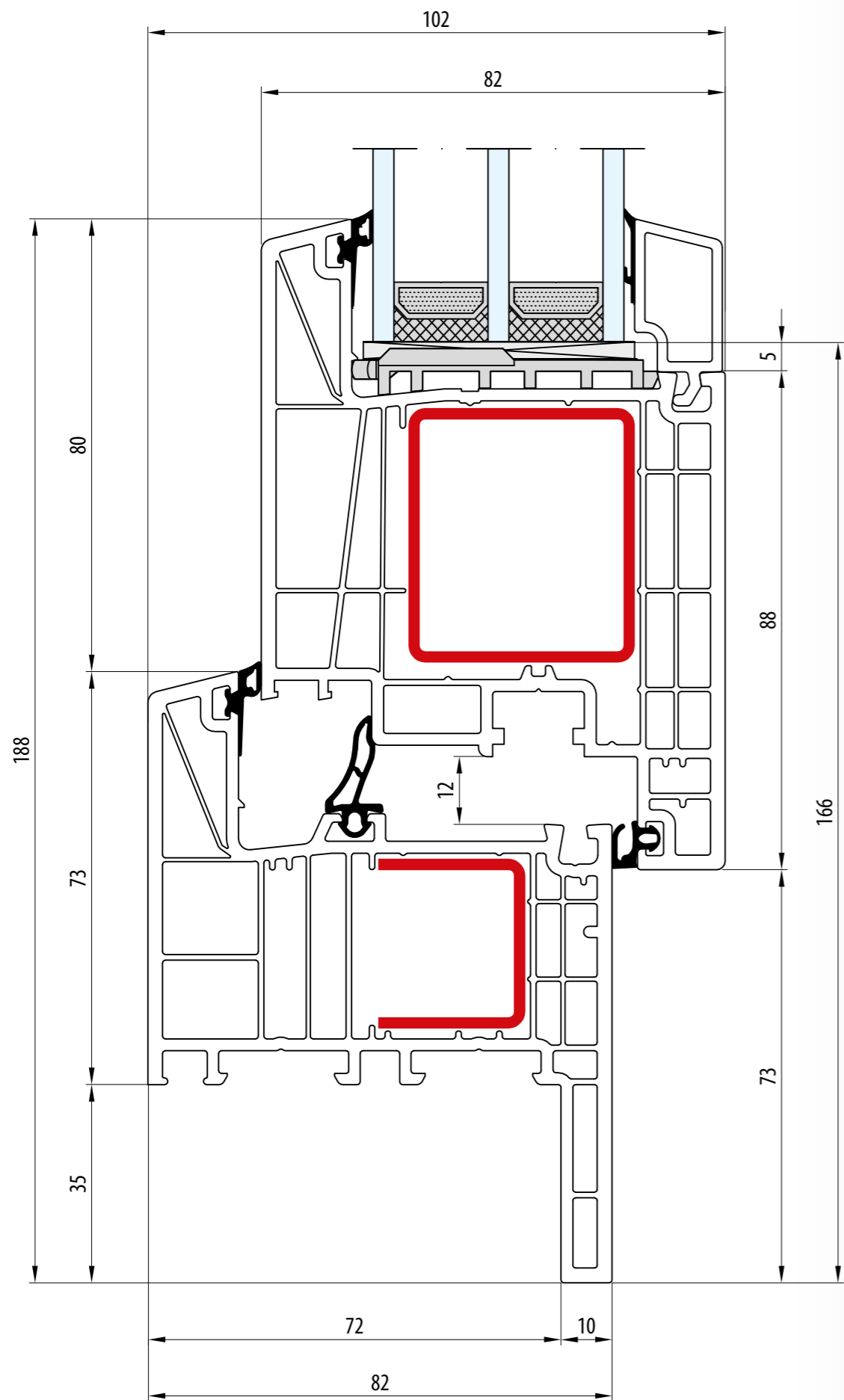



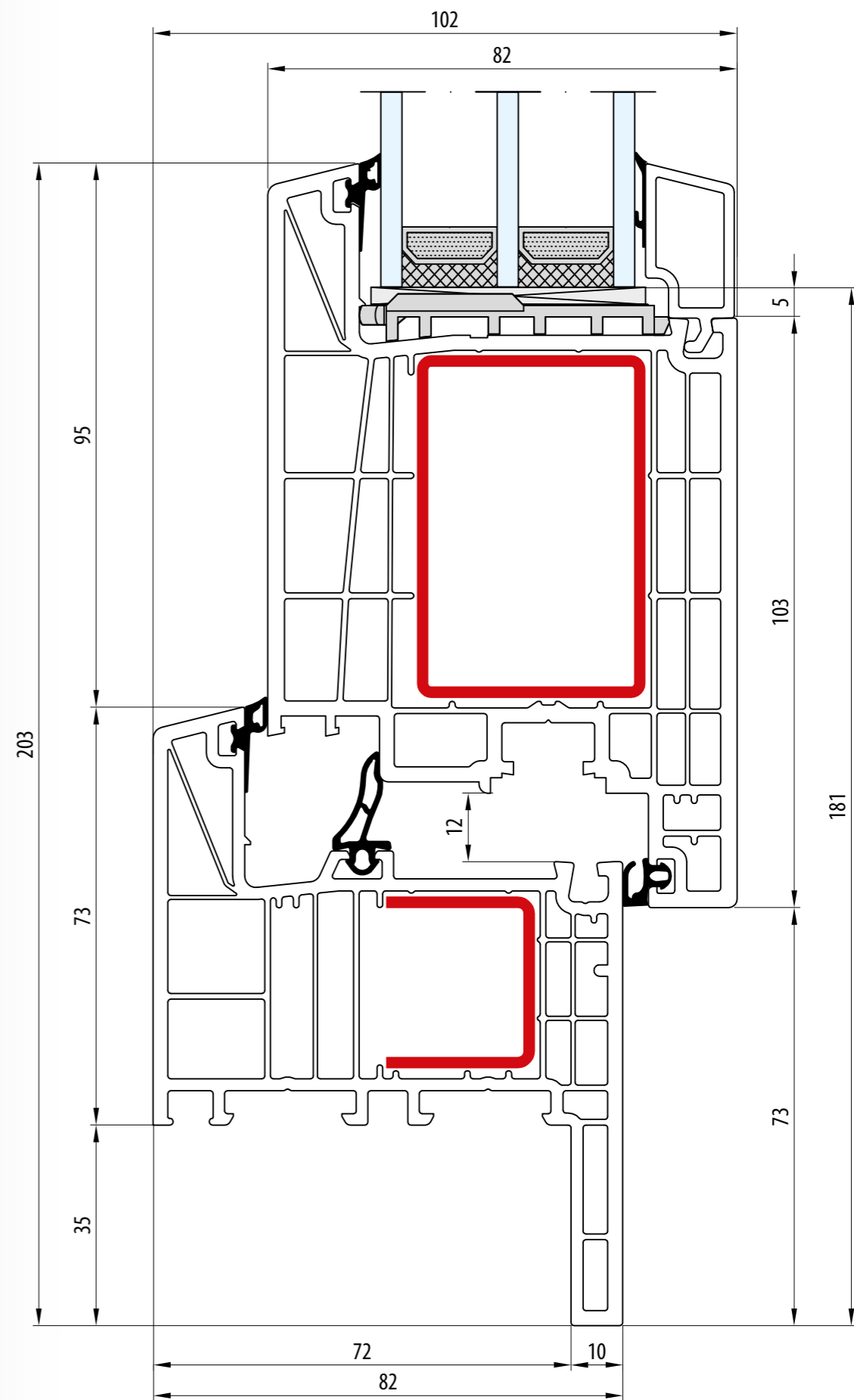
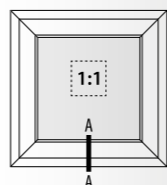

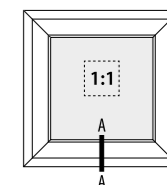

- RENOWACJA - Pletwa: 35 mm · Rama: 73 mm · Skrzydło: 115 mm
- RÉNOVATION - Lip: 35 mm · Dormant: 73 mm · Vantail: 115 mm
- RENOVATION - Strip: 35 mm · Frame: 73 mm · Sash: 115 mm
- RENOVIERUNG - Flosse: 35 mm · Rahmen: 73 mm · Flügel: 115 mm
- RINNOVAZIONE - Aletta da: 35 mm · Telaio: 73 mm · Anta: 115 mm

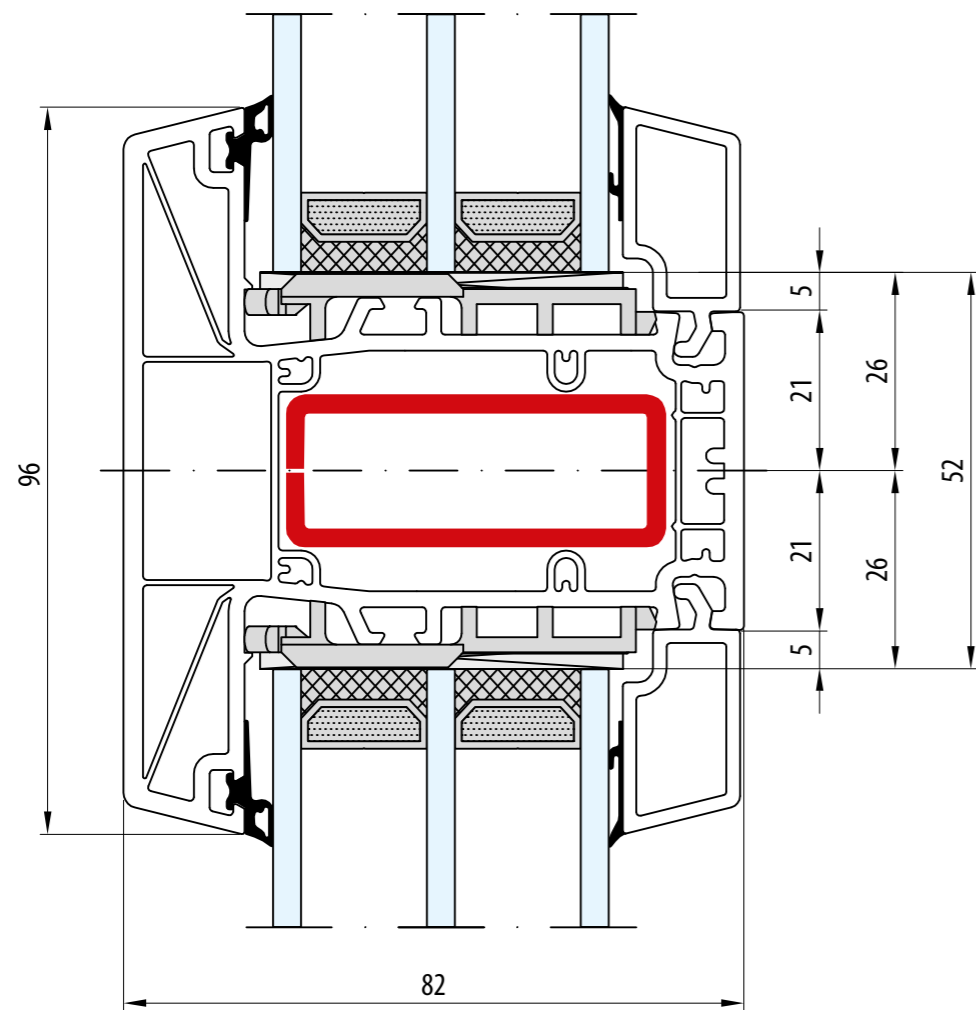







- RENOWACJA - Pletwa: 35 mm · Rama: 73 mm · Skrzydło: 130 mm
- RÉNOVATION - Lip: 35 mm · Dormant: 73 mm · Vantail: 130 mm
- RENOVATION - Strip: 35 mm · Frame: 73 mm · Sash: 130 mm
- RENOVIERUNG - Flosse: 35 mm · Rahmen: 73 mm · Flügel: 130 mm
- RINNOVAZIONE - Aletta da: 35 mm · Telaio: 73 mm · Anta: 130 mm

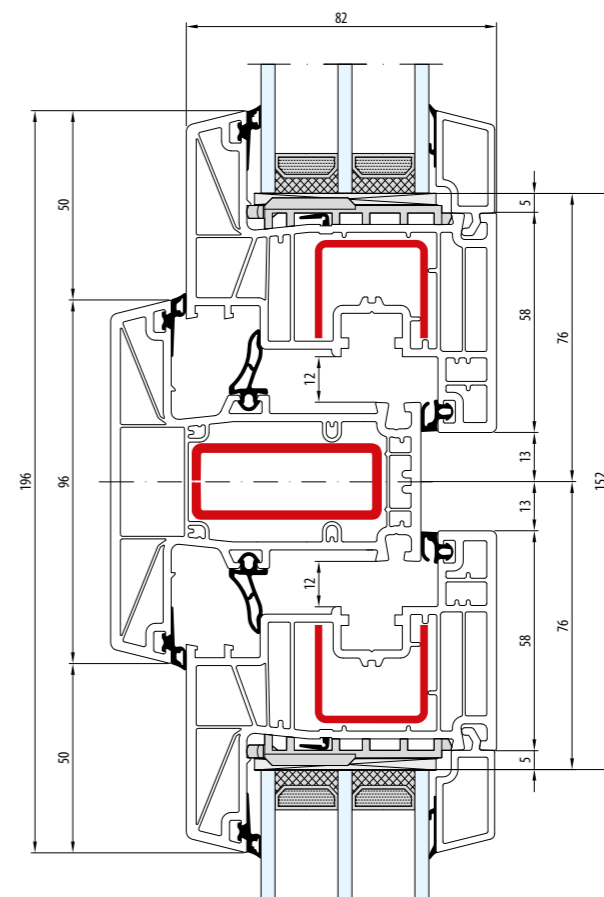
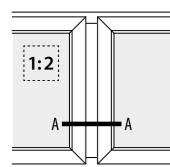
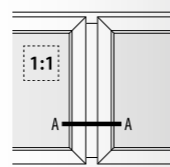



-  Słupek stalowy: 96 mm
-  Meneau fixe: 96 mm
-  Fix post: 96 mm
-  Festem Pfahl: 96 mm
-  Montante fissa: 96 mm



-  Słupek stalowy: 96 mm · Skrzydło: 85 mm
-  Meneau fixe: 96 mm · Vantail: 85 mm
-  Fix post: 96 mm · Sash: 85 mm
-  Festem Pfahl: 96 mm · Flügel: 85 mm
-  Montante fissa: 96 mm · Anta: 85 mm

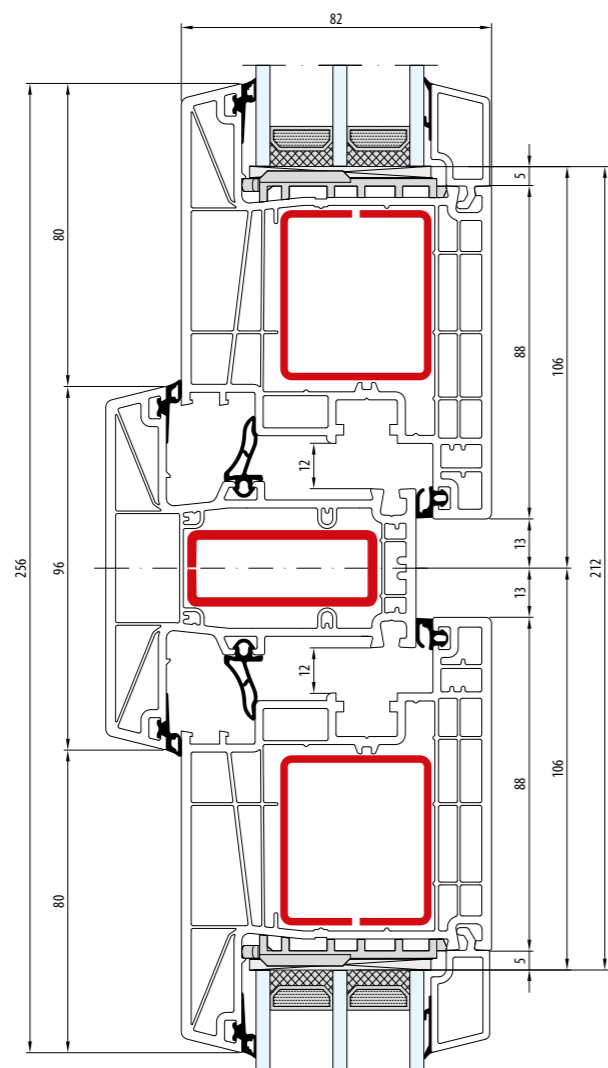

- Słupek stalowy: 96 mm · Skrzydło: 115 mm
- Meneau fixe: 96 mm · Vantail: 115 mm
- Fix post: 96 mm · Sash: 115 mm
- Festem Pfahl: 96 mm · Flügel: 115 mm
- Montante fisso: 96 mm · Anta: 115 mm

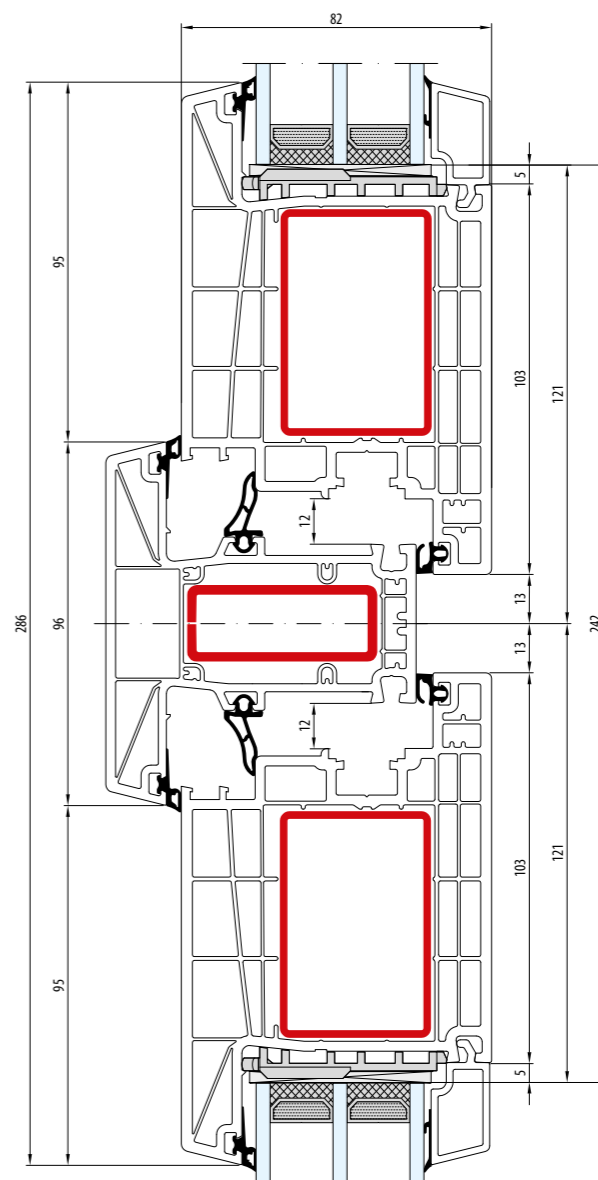
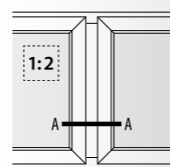

- Słupek stalowy: 96 mm · Skrzydło: 130 mm
- Meneau fixe: 96 mm · Vantail: 130 mm
- Fix post: 96 mm · Sash: 130 mm
- Festem Pfahl: 96 mm · Flügel: 130 mm
- Montante fisso: 96 mm · Anta: 130 mm

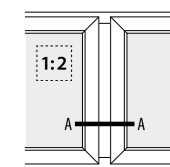

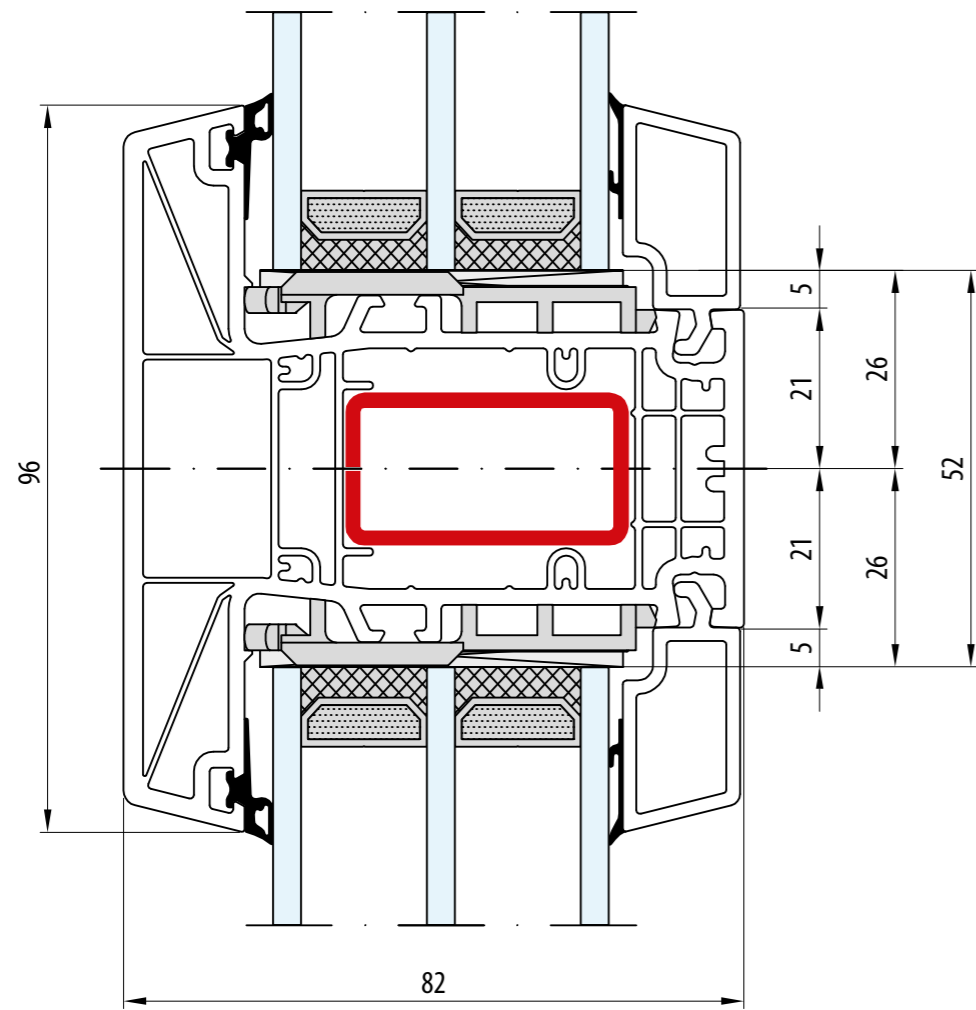

- Słupek stalowy: 96 mm
- Meneau fixe: 96 mm
- Fix post: 96 mm
- Festem Pfahl: 96 mm
- Montante fisso: 96 mm

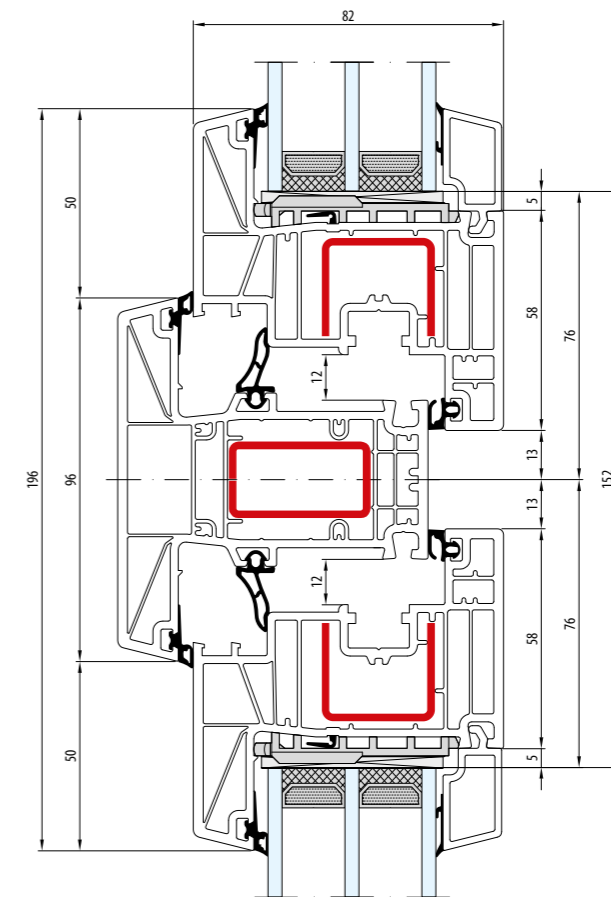
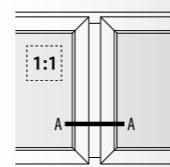

- Słupek stalowy: 96 mm · Skrzydło: 85 mm
- Meneau fixe: 96 mm · Vantail: 85 mm
- Fix post: 96 mm · Sash: 85 mm
- Festem Pfahl: 96 mm · Flügel: 85 mm
- Montante fisso: 96 mm · Anta: 85 mm

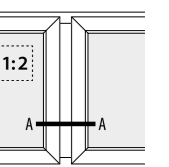

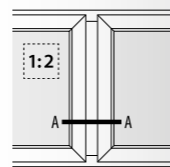
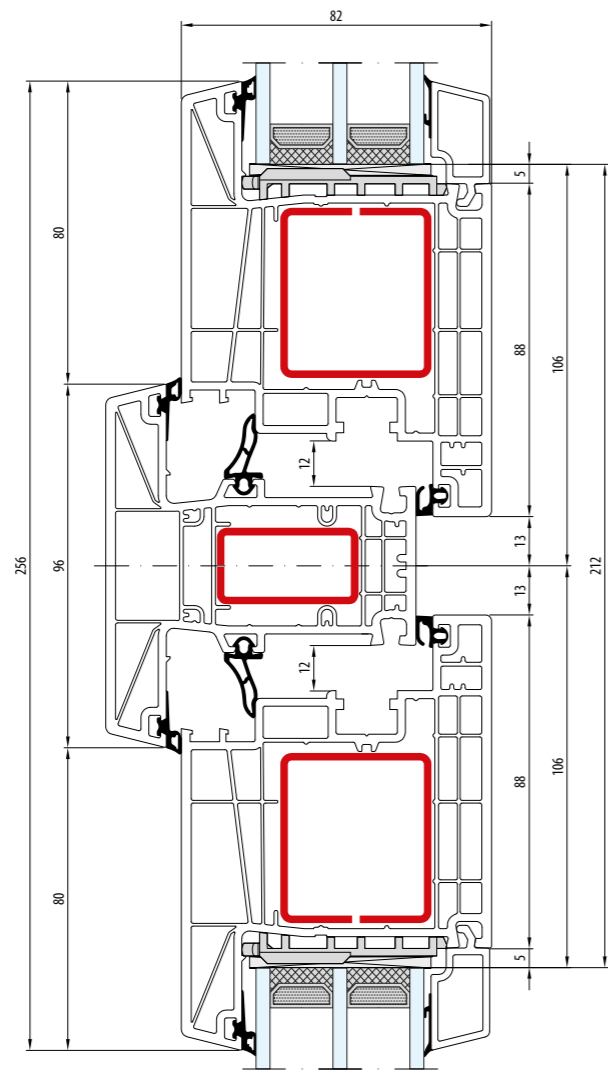

- Słupek stalowy: 96 mm · Skrzydło: 115 mm
- Meneau fixe: 96 mm · Vantail: 115 mm
- Fix post: 96 mm · Sash: 115 mm
- Festem Pfahl: 96 mm · Flügel: 115 mm
- Montante fisso: 96 mm · Anta: 115 mm

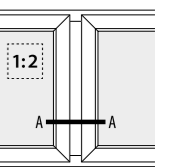
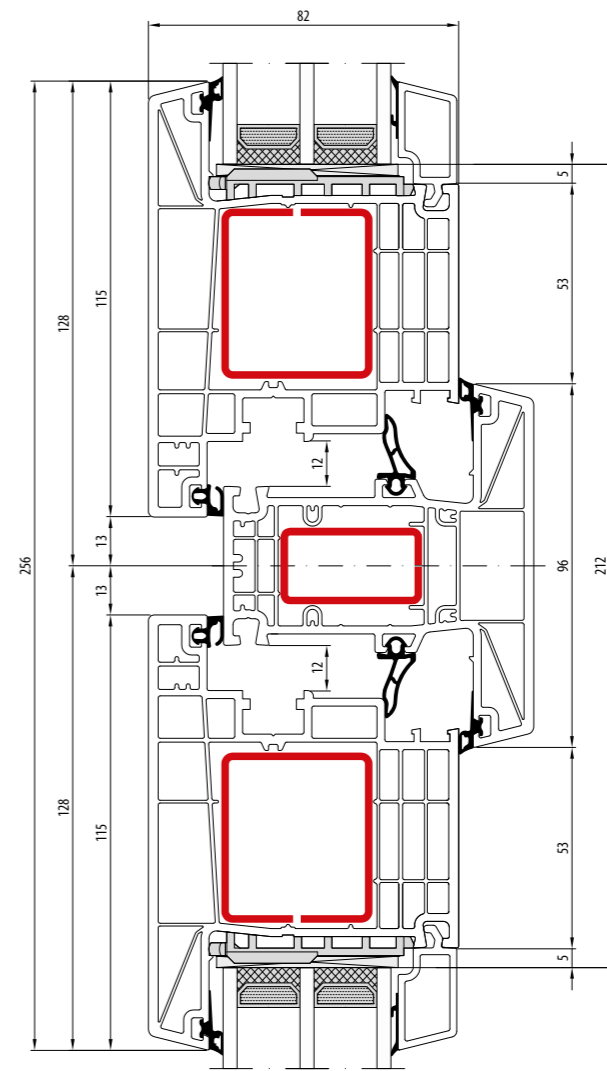

- Słupek stalowy: 96 mm · Skrzydło: 115 mm
- Meneau fixe: 96 mm · Vantail: 115 mm
- Fix post: 96 mm · Sash: 115 mm
- Festem Pfahl: 96 mm · Flügel: 115 mm
- Montante fisso: 96 mm · Anta: 115 mm

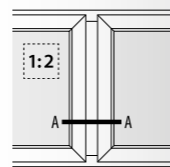
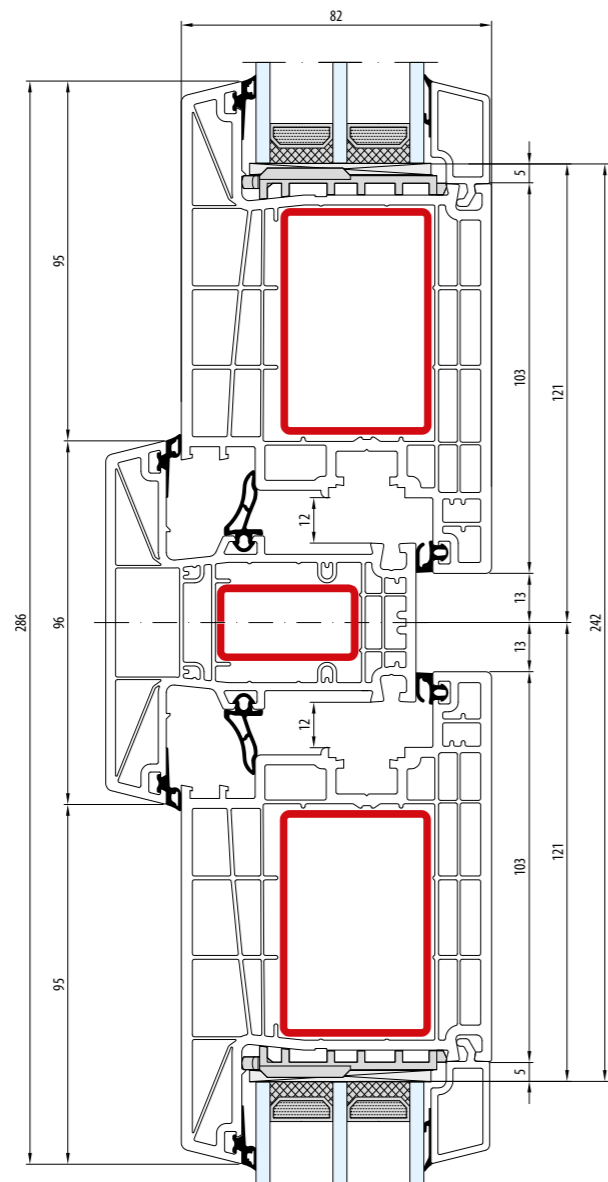

- Słupek stały: 96 mm · Skrzydło: 130 mm
- Meneau fixe: 96 mm · Vantail: 130 mm
- Fix post: 96 mm · Sash: 130 mm
- Festem Pfahl: 96 mm · Flügel: 130 mm
- Montante fisso: 96 mm · Anta: 130 mm

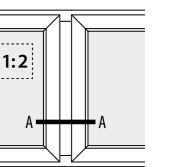
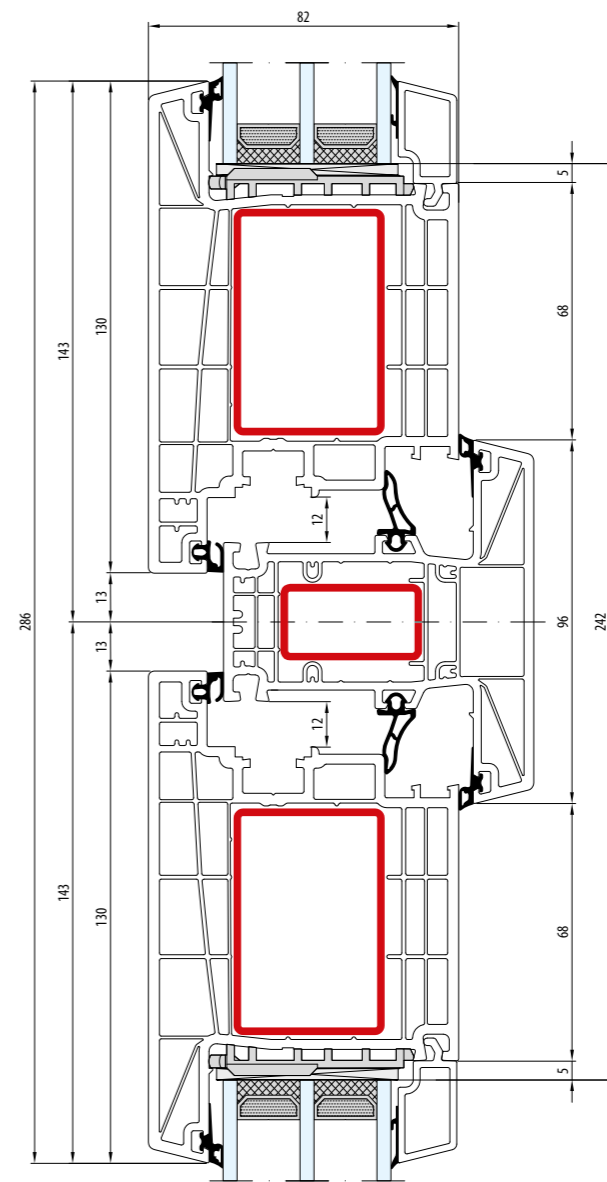

- Słupek stały: 96 mm · Skrzydło: 130 mm
- Meneau fixe: 96 mm · Vantail: 130 mm
- Fix post: 96 mm · Sash: 130 mm
- Festem Pfahl: 96 mm · Flügel: 130 mm
- Montante fisso: 96 mm · Anta: 130 mm

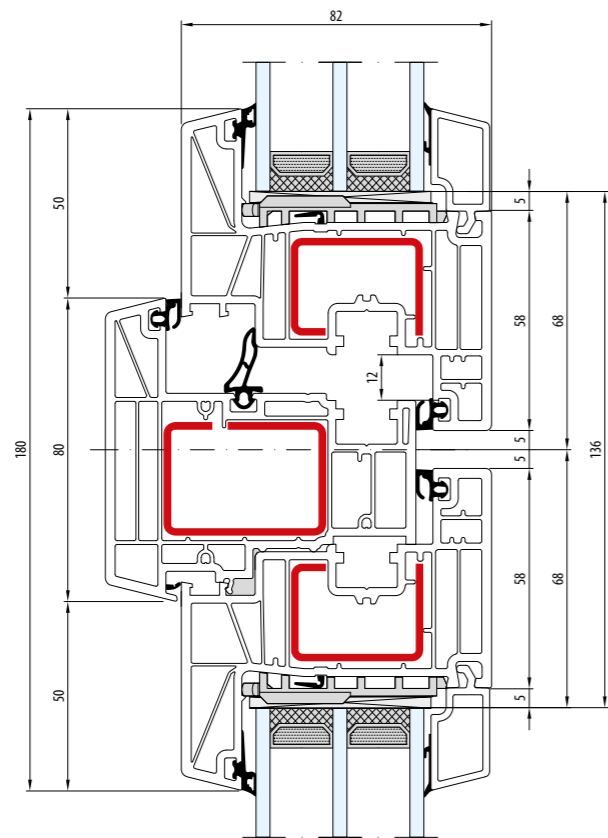

- Słupek ruchomy: 80 mm · Skrzydło: 85 mm
- Meneau mobile: 80 mm · Vantail: 85 mm
- Movable post: 80 mm · Sash: 85 mm
- Stulp: 80 mm · Flügel: 85 mm
- Montante mobile: 80 mm · Anta: 85 mm

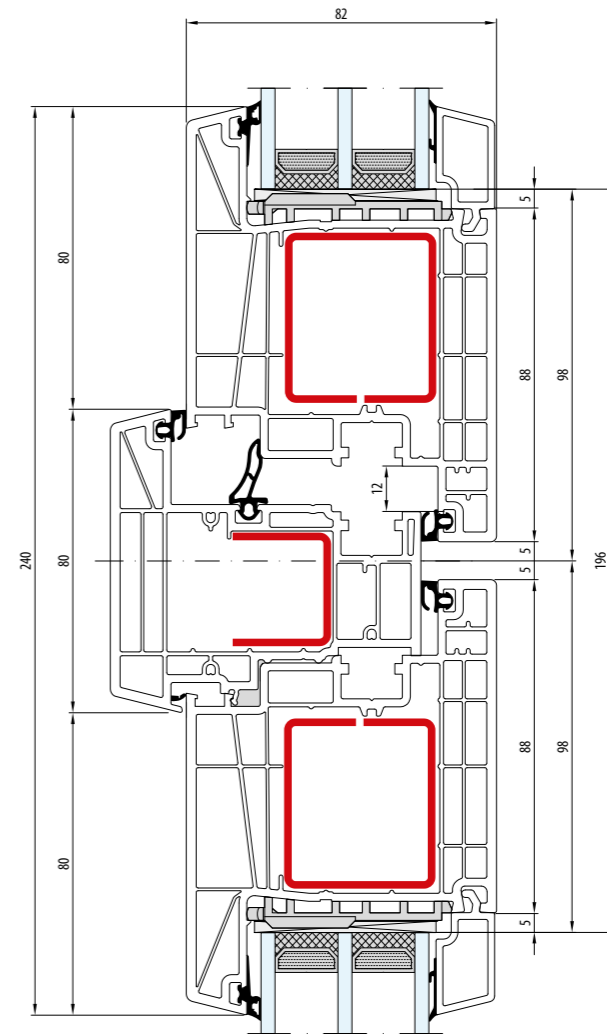
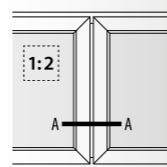

- Słupek ruchomy: 80 mm · Skrzydło: 115 mm
- Meneau mobile: 80 mm · Vantail: 115 mm
- Movable post: 80 mm · Sash: 115 mm
- Stulp: 80 mm · Flügel: 115 mm
- Montante mobile: 80 mm · Anta: 115 mm

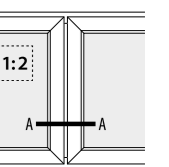

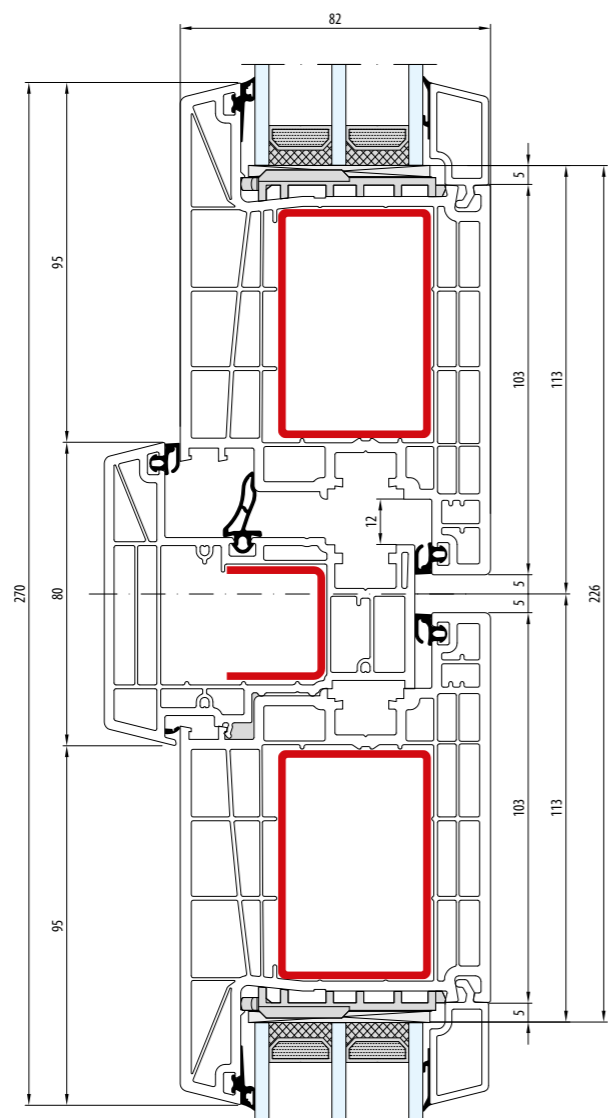

- Słupek ruchomy: 80 mm · Skrzydło: 130 mm
- Meneau mobile: 80 mm · Vantail: 130 mm
- Movable post: 80 mm · Sash: 130 mm
- Stulp: 80 mm · Flügel: 130 mm
- Montante mobile: 80 mm · Anta: 130 mm

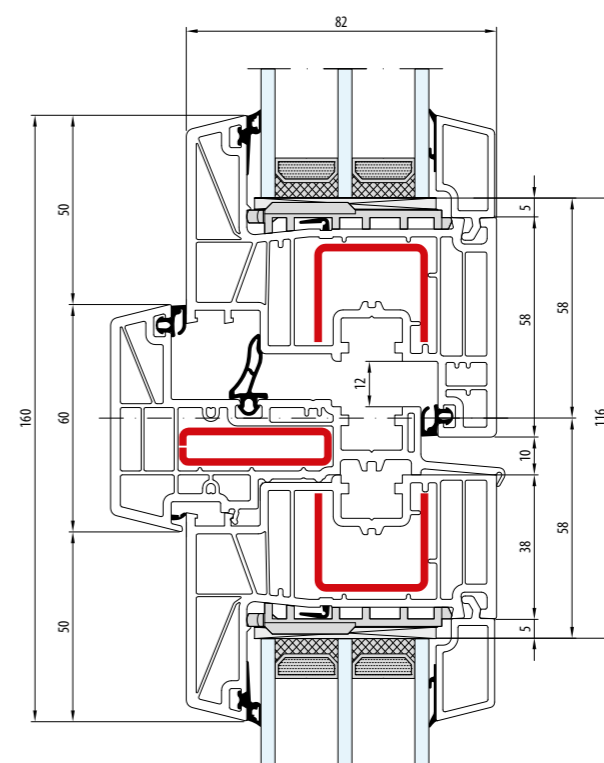
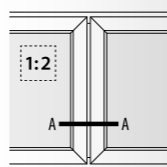

- Słupek ruchomy: 60 mm · Skrzydło: 85 mm / 65 mm
- Meneau mobile: 60 mm · Vantail: 85 mm / 65 mm
- Movable post: 60 mm · Sash: 85 mm / 65 mm
- Stulp: 60 mm · Flügel: 85 mm / 65 mm
- Montante mobile: 60 mm · Anta: 85 mm / 65 mm

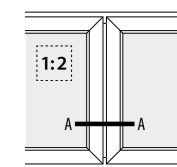

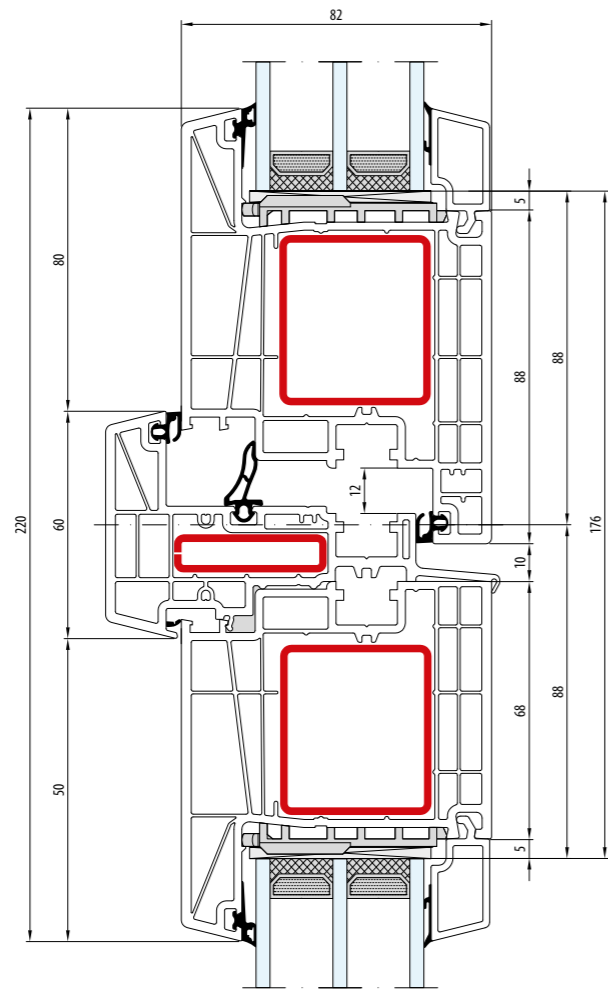

- Słupek ruchomy: 60 mm · Skrzydło: 115 mm / 95 mm
- Meneau mobile: 60 mm · Vantail: 115 mm / 95 mm
- Movable post: 60 mm · Sash: 115 mm / 95 mm
- Stulp: 60 mm · Flügel: 115 mm / 95 mm
- Montante mobile: 60 mm · Anta: 115 mm / 95 mm

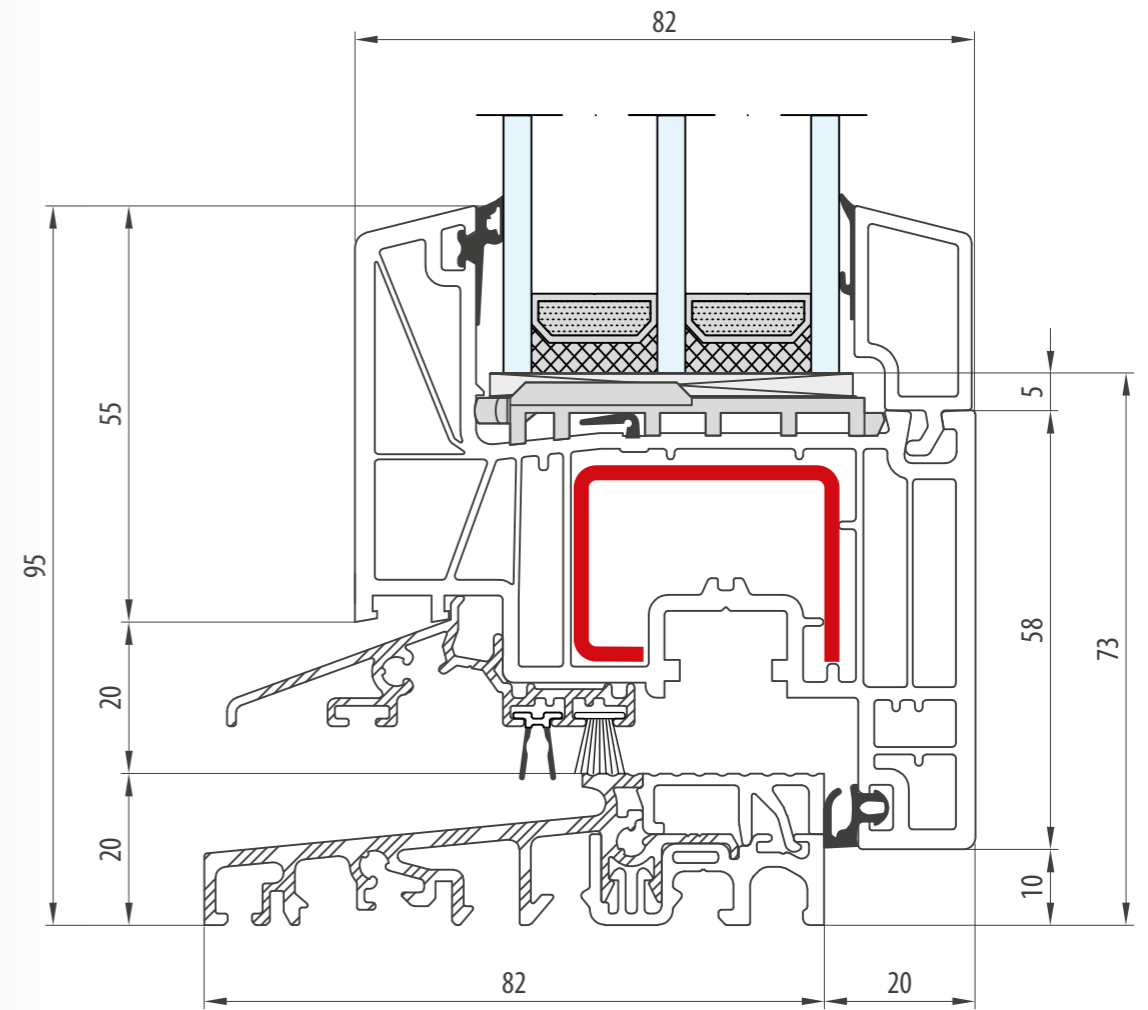
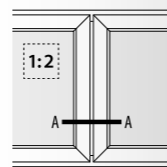

- Próg: 20 mm · Skrzydło: 85 mm
- Seuil: 20 mm · Vantail: 85 mm
- Threshold: 20 mm · Sash: 85 mm
- Schwelle: 20 mm · Flügel: 85 mm
- Soglia: 20 mm · Anta: 85 mm

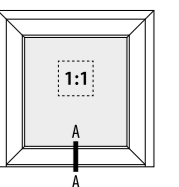

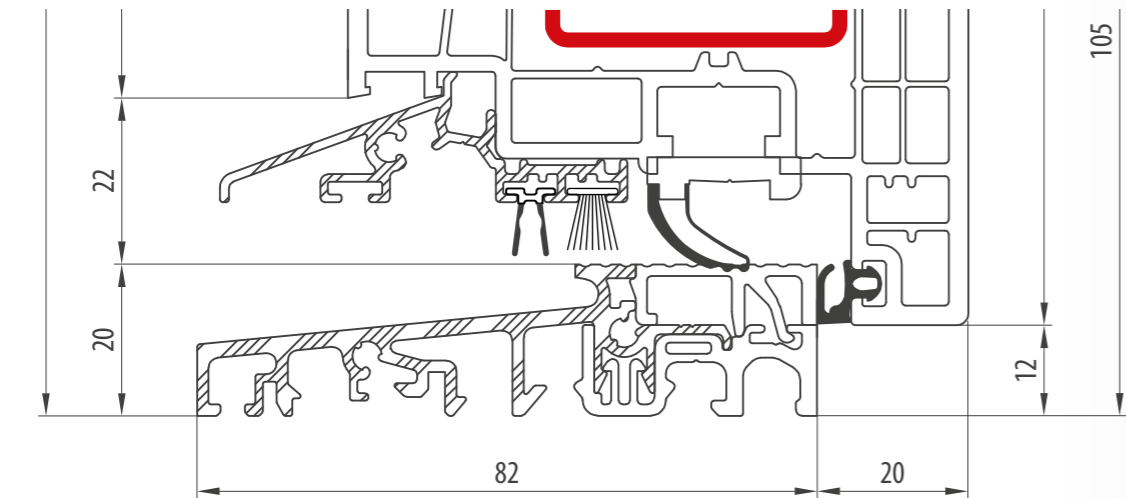
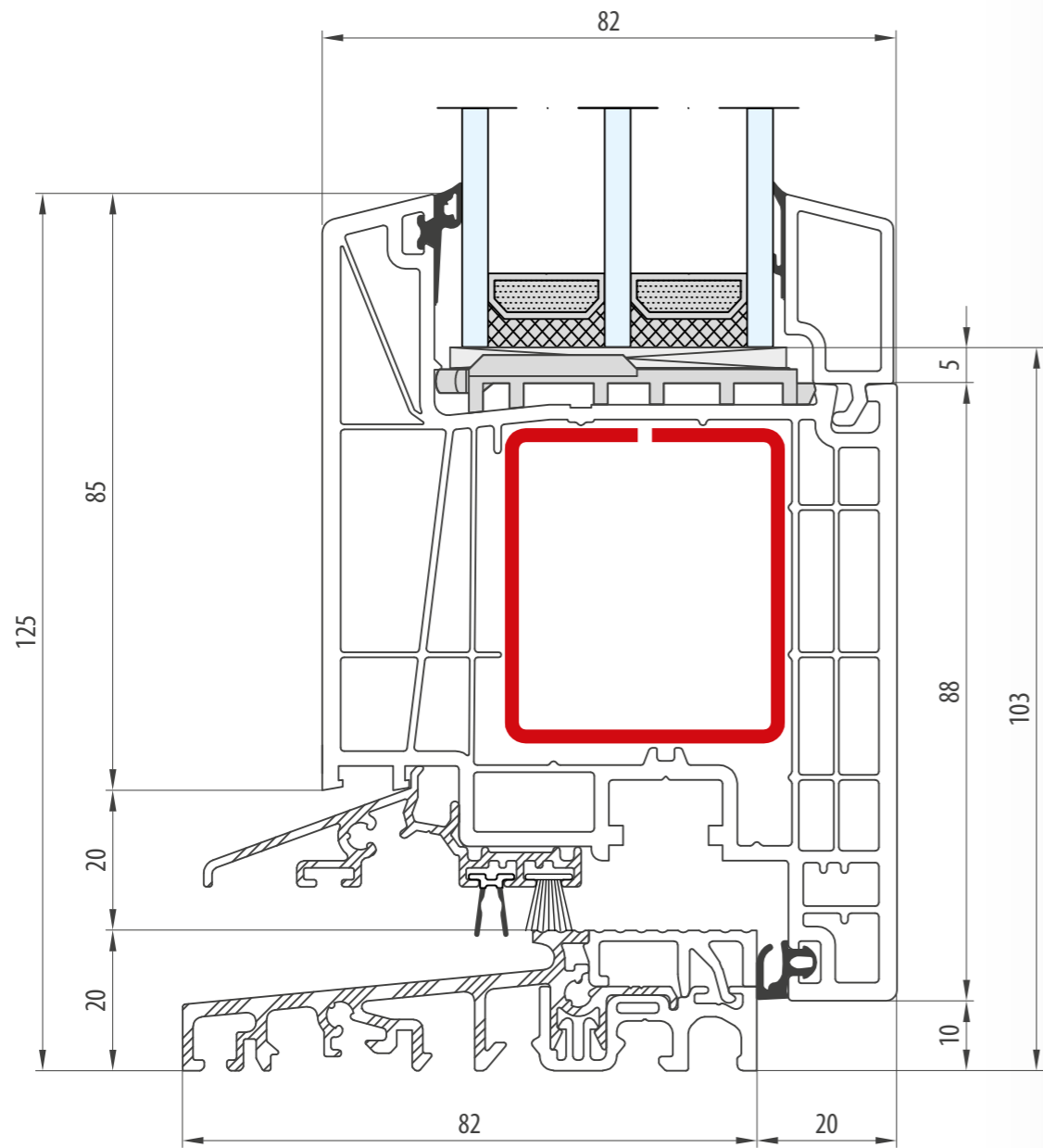

- Próg: 20 mm · Skrzydło: 115 mm
- Seuil: 20 mm · Vantail: 115 mm
- Threshold: 20 mm · Sash: 115 mm
- Schwelle: 20 mm · Flügel: 115 mm
- Soglia: 20 mm · Anta: 115 mm

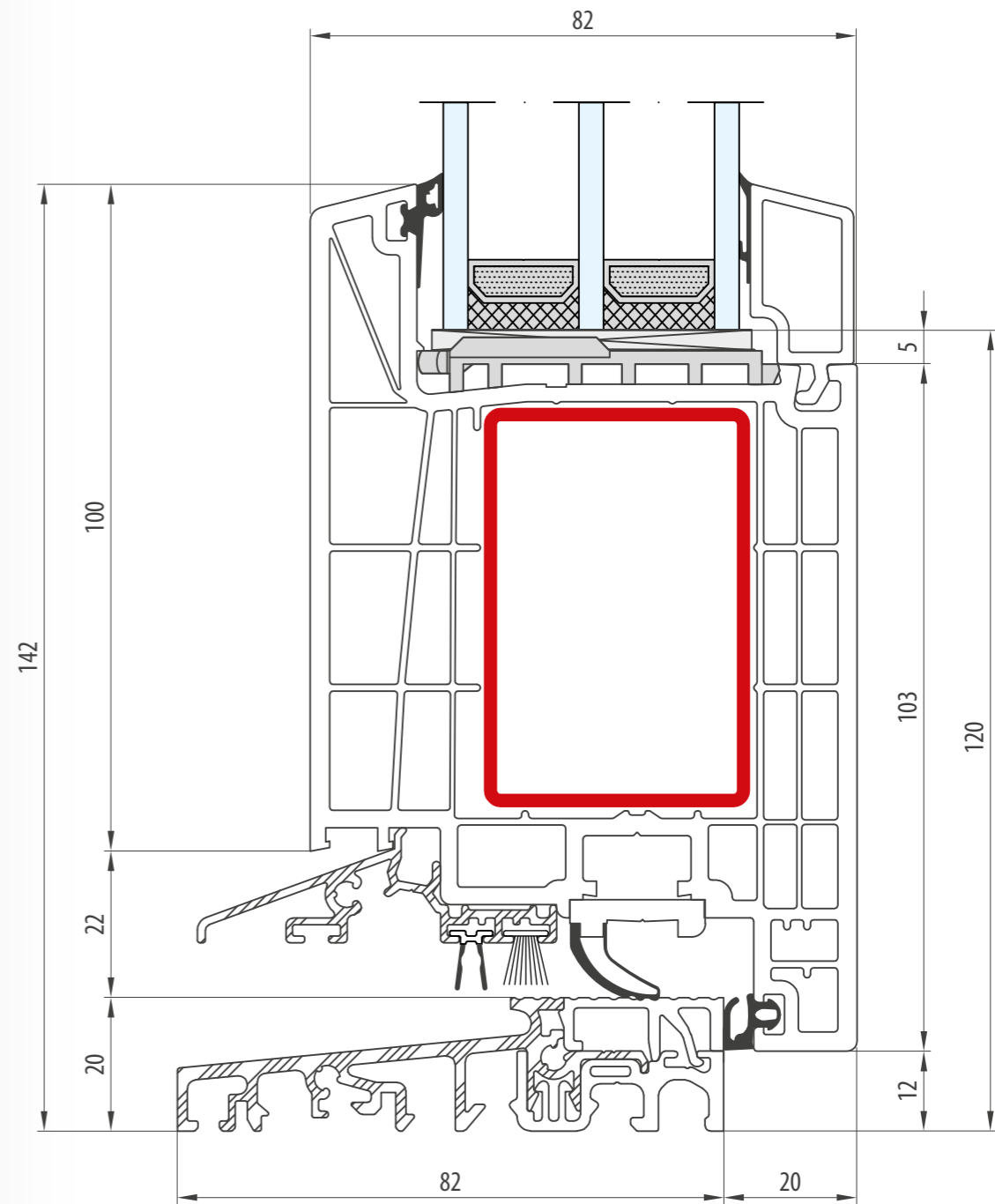
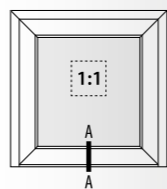

- Próg: 20 mm · Skrzydło: 130 mm
- Seuil: 20 mm · Vantail: 130 mm
- Threshold: 20 mm · Sash: 130 mm
- Schwelle: 20 mm · Flügel: 130 mm
- Soglia: 20 mm · Anta: 130 mm

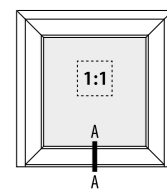

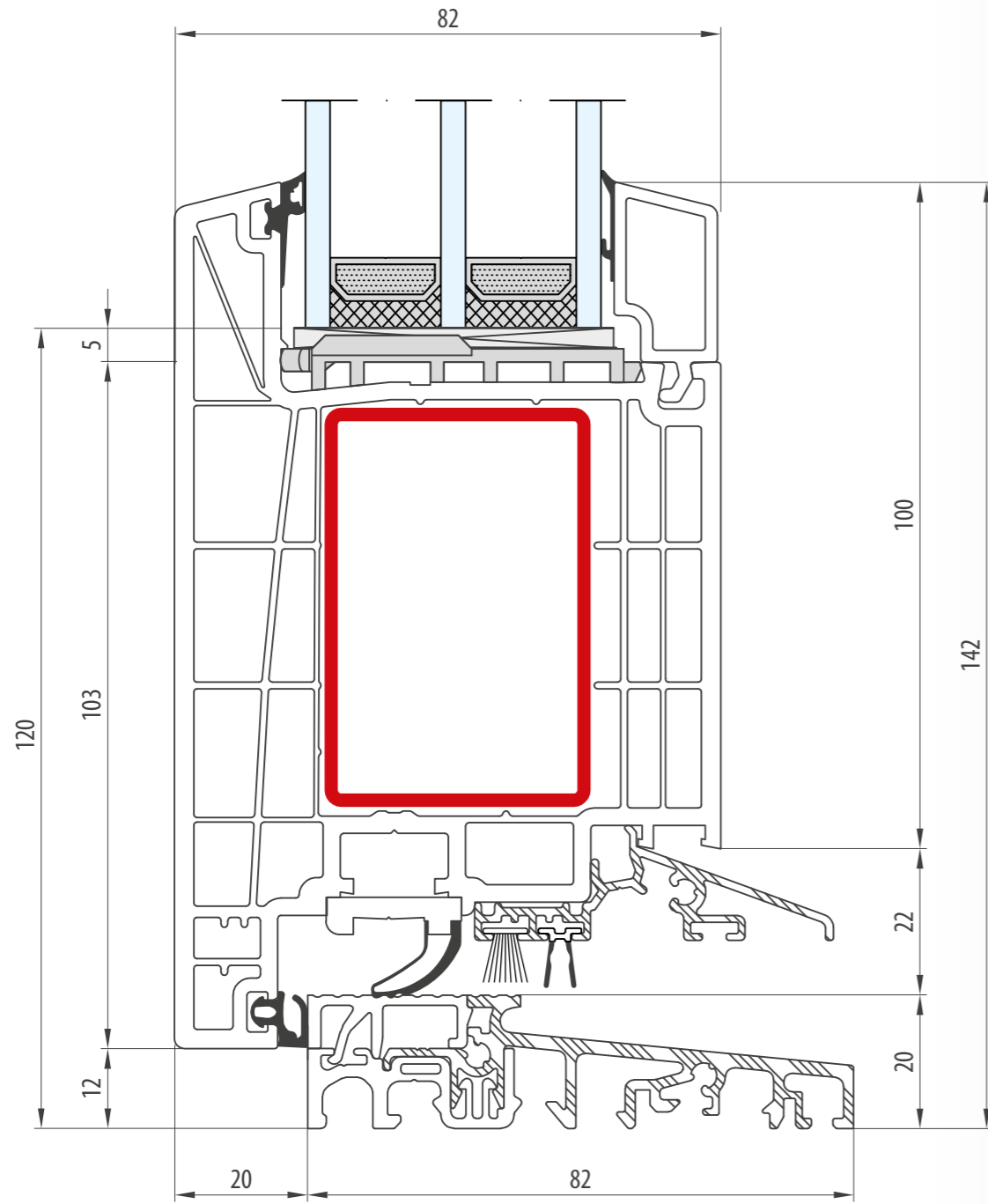

- Próg: 20 mm · Skrzydło: 130 mm
- Seuil: 20 mm · Vantail: 130 mm
- Threshold: 20 mm · Sash: 130 mm
- Schwelle: 20 mm · Flügel: 130 mm
- Soglia: 20 mm · Anta: 130 mm

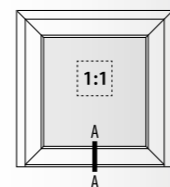

BLUEVOLUTION 92

STREAMLINE 76

BLUEVOLUTION 82

BLUEVOLUTION 92

STREAMLINE 76

BLUEVOLUTION 82

BLUEVOLUTION 92



6	3	92	61	V-PERFECT

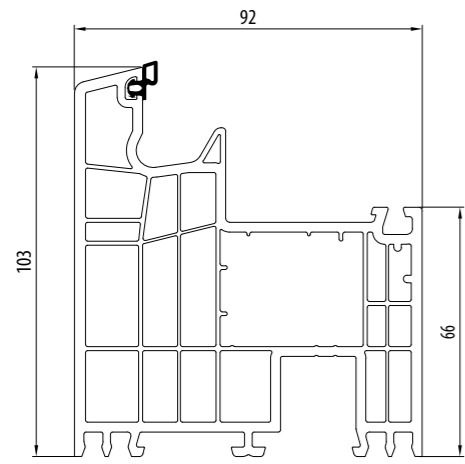

cl A* 170 430

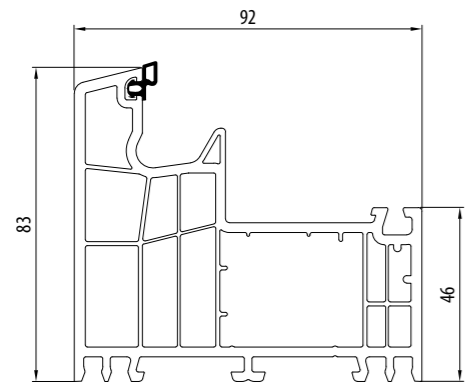

cl A* 170 820

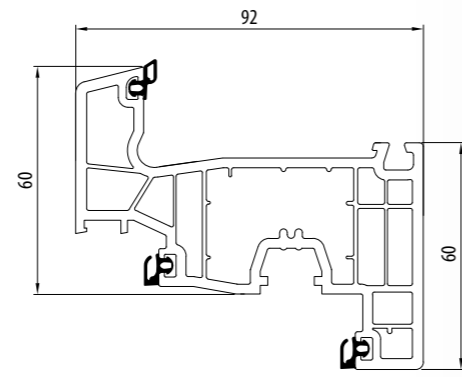

cl A* 171 020

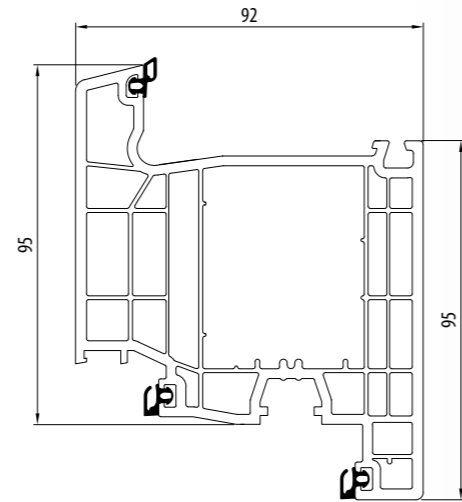

cl A* 171 030

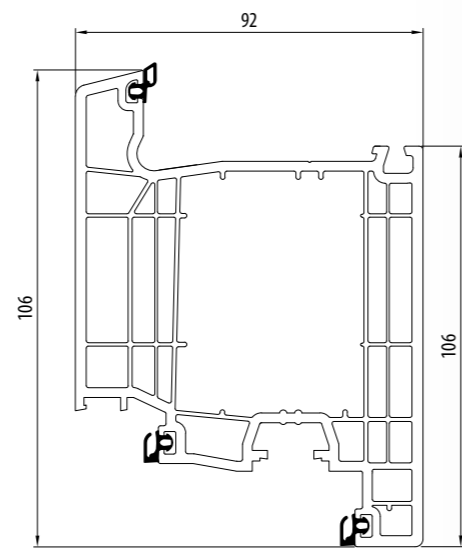

cl A* 171 040

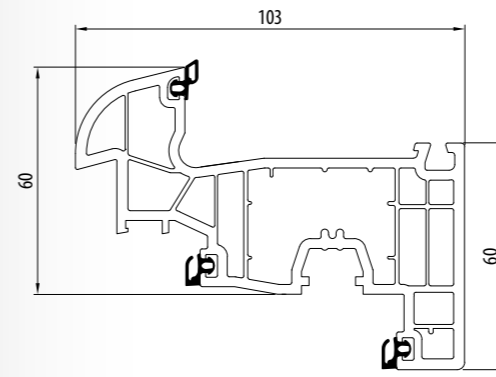

RL A* 171 226

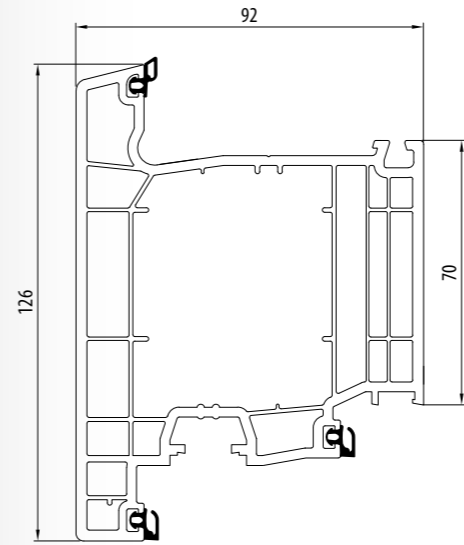

cl A* 371 040

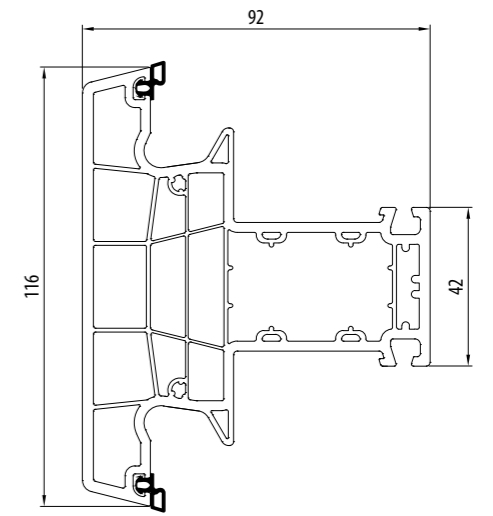

cl A* 172 420

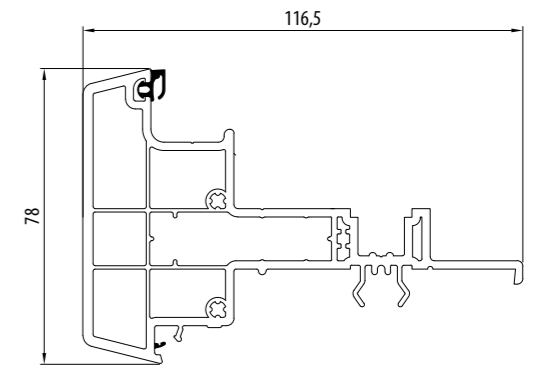

cl A* 176 020

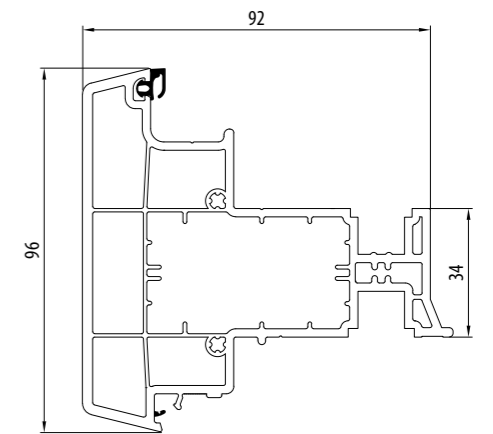

cl A* 176 030

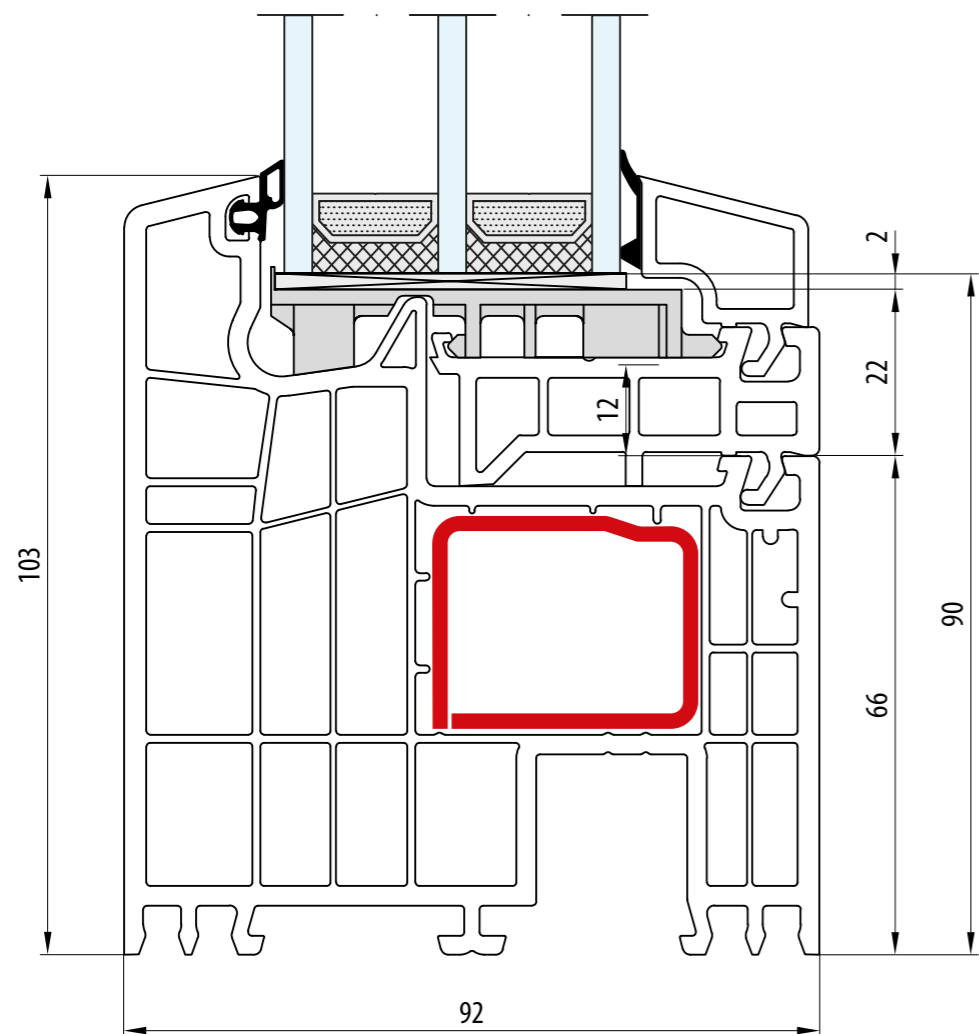

- Rama: 103 mm
- Dormant: 103 mm
- Frame: 103 mm
- Rahmen: 103 mm
- Telaio: 103 mm

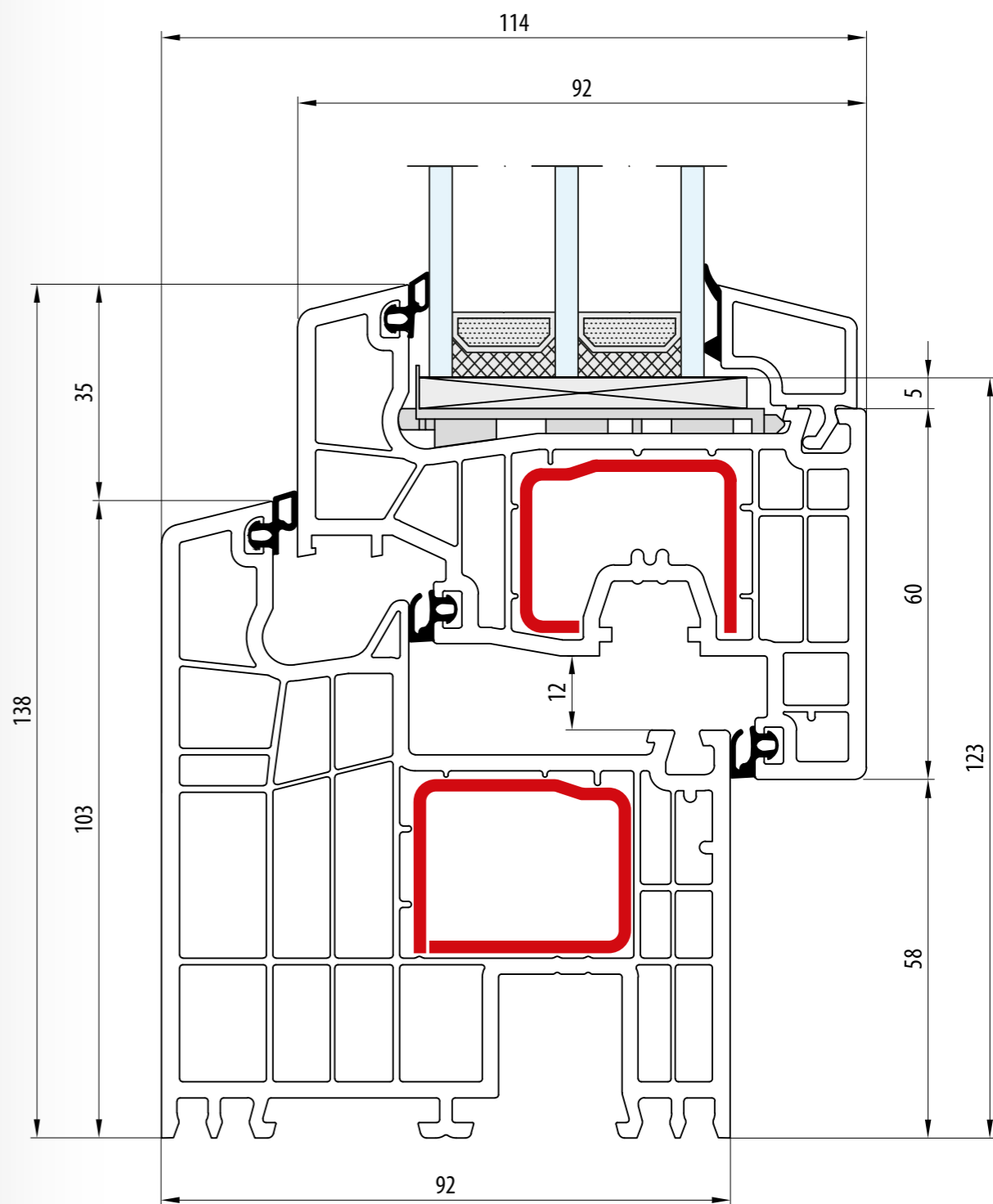
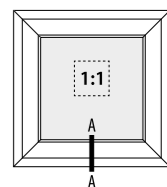
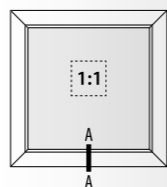

- Rama: 103 mm · Skrzydło: 80 mm
- Dormant: 103 mm · Vantail: 80 mm
- Frame: 103 mm · Sash: 80 mm
- Rahmen: 103 mm · Flügel: 80 mm
- Telaio: 103 mm · Anta: 80 mm

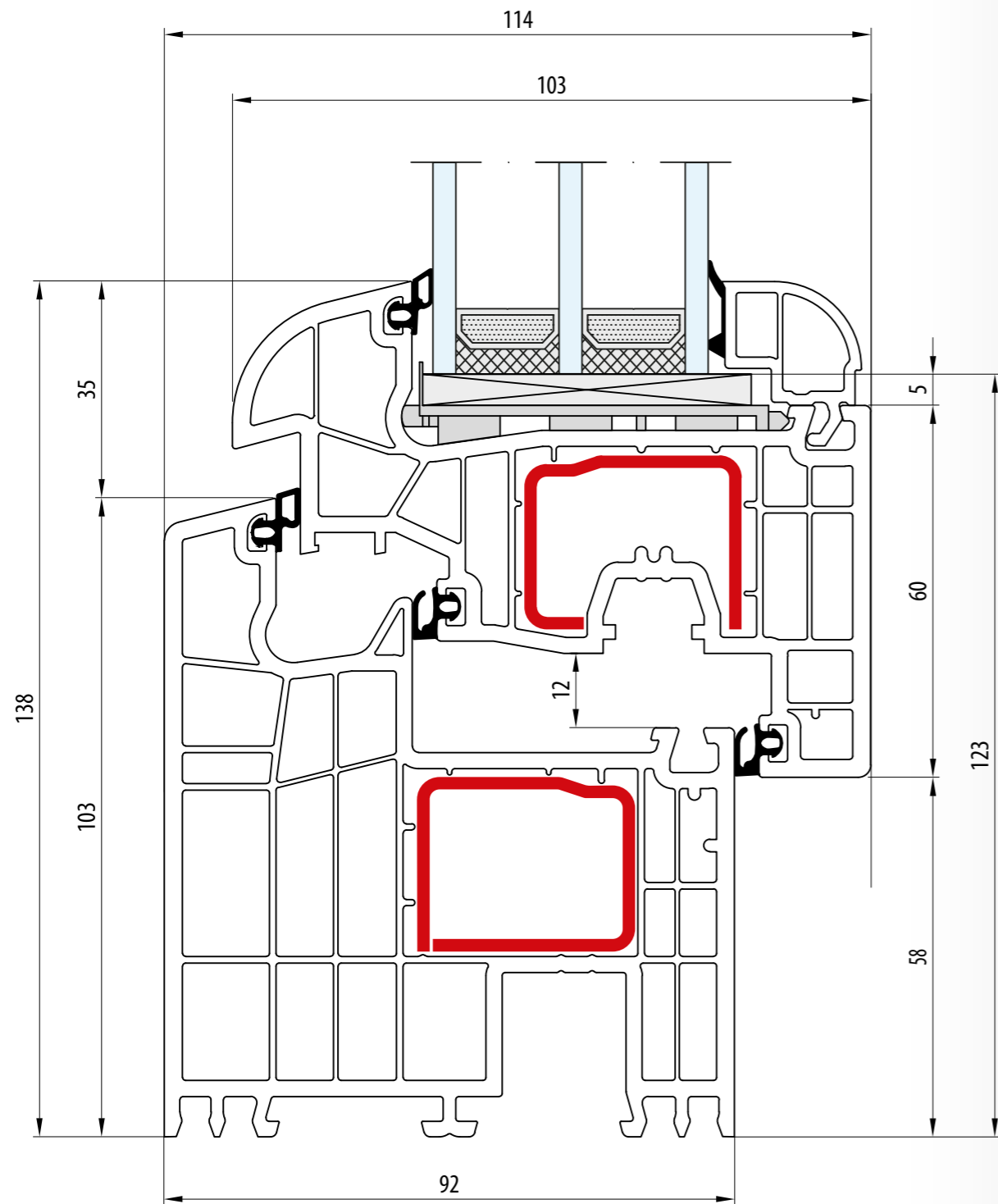

- Rama: 103 mm · Skrzydło: 80 mm
- Dormant: 103 mm · Vantail: 80 mm
- Frame: 103 mm · Sash: 80 mm
- Rahmen: 103 mm · Flügel: 80 mm
- Telaio: 103 mm · Anta: 80 mm

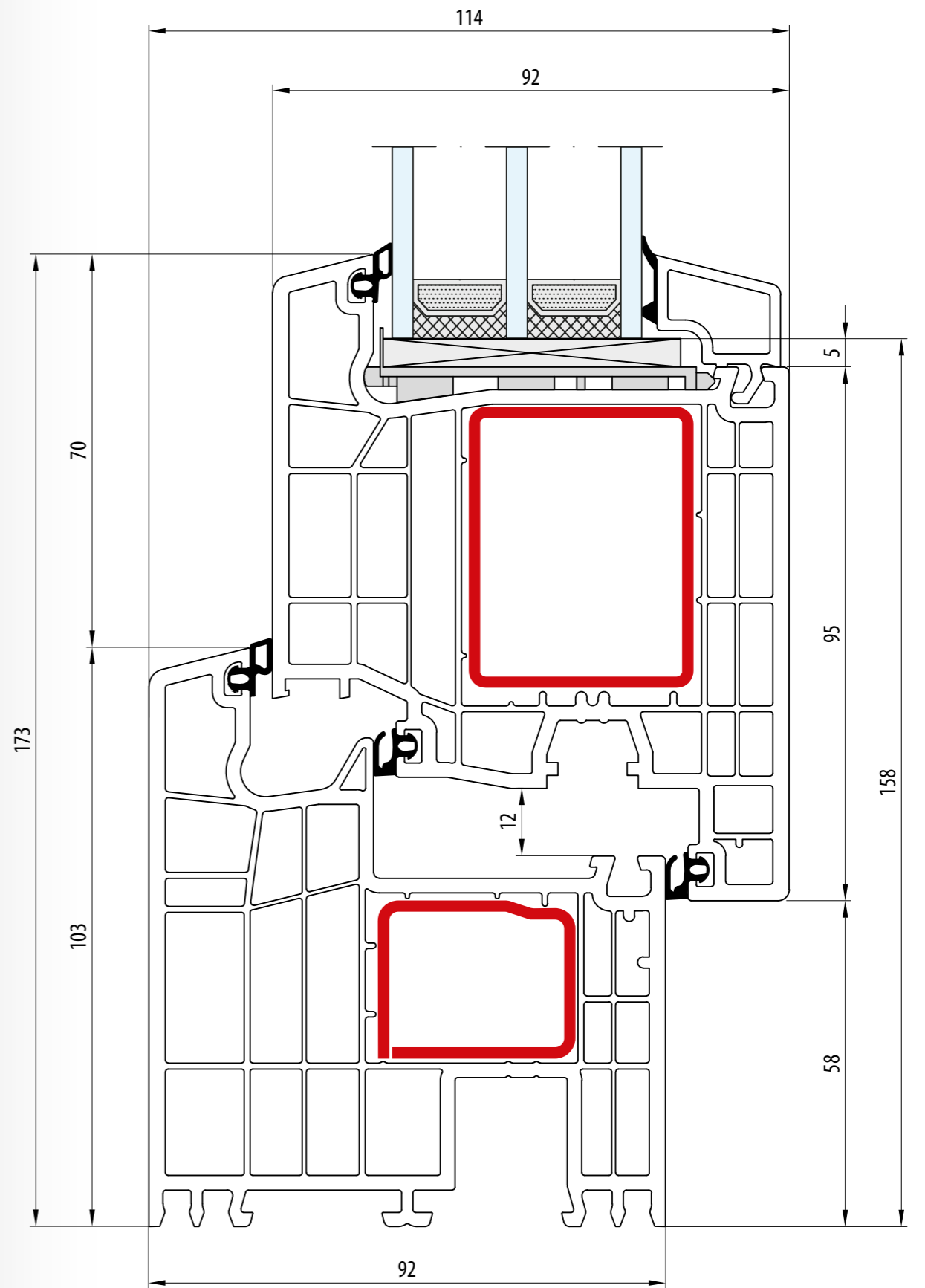
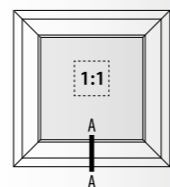

- Rama: 103 mm · Skrzydło: 115 mm
- Dormant: 103 mm · Vantail: 115 mm
- Frame: 103 mm · Sash: 115 mm
- Rahmen: 103 mm · Flügel: 115 mm
- Telaio: 103 mm · Anta: 115 mm

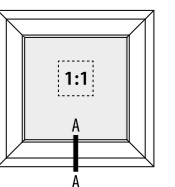

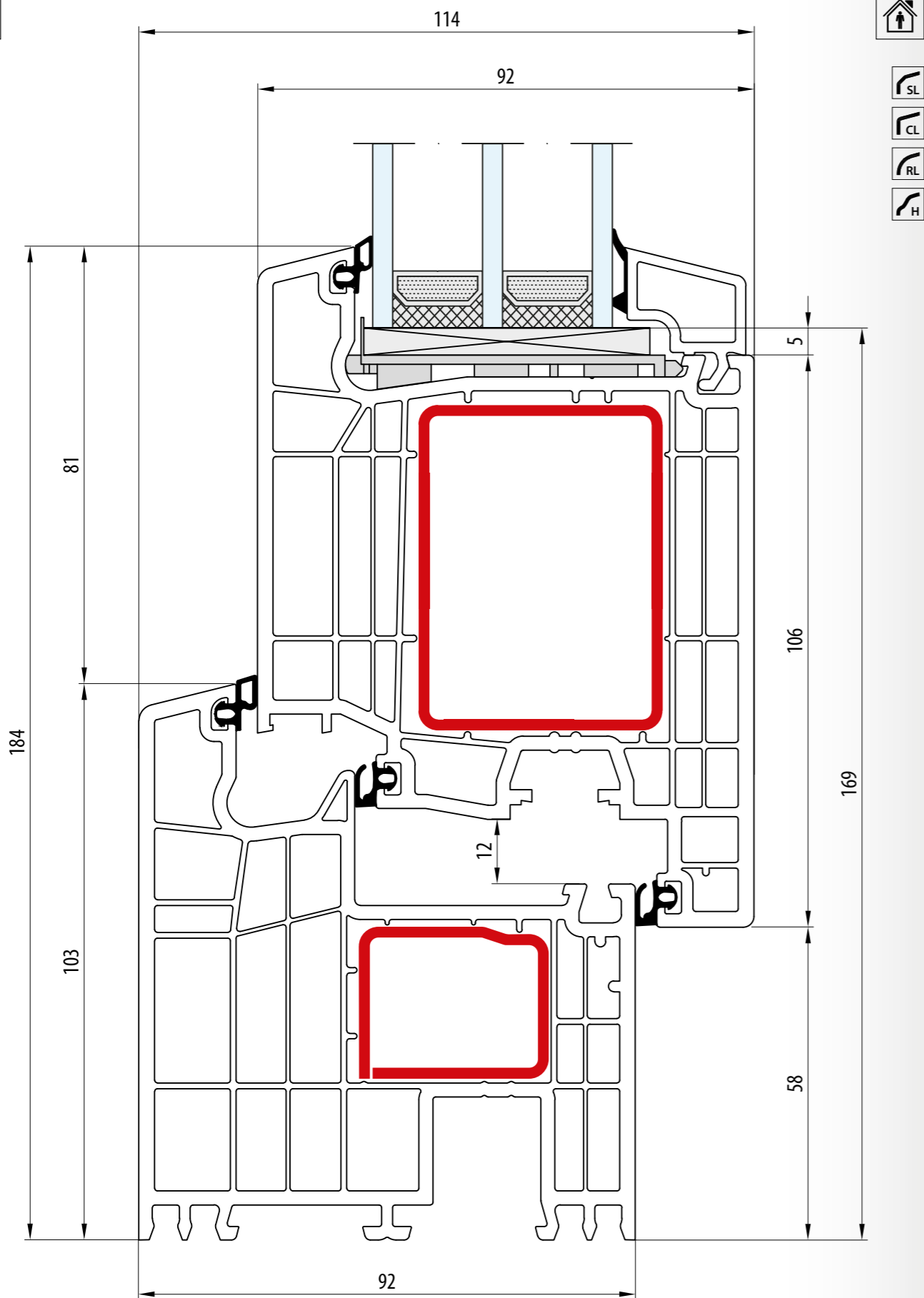

- Rama: 103 mm · Skrzydło: 126 mm
- Dormant: 103 mm · Vantail: 126 mm
- Frame: 103 mm · Sash: 126 mm
- Rahmen: 103 mm · Flügel: 126 mm
- Telaio: 103 mm · Anta: 126 mm

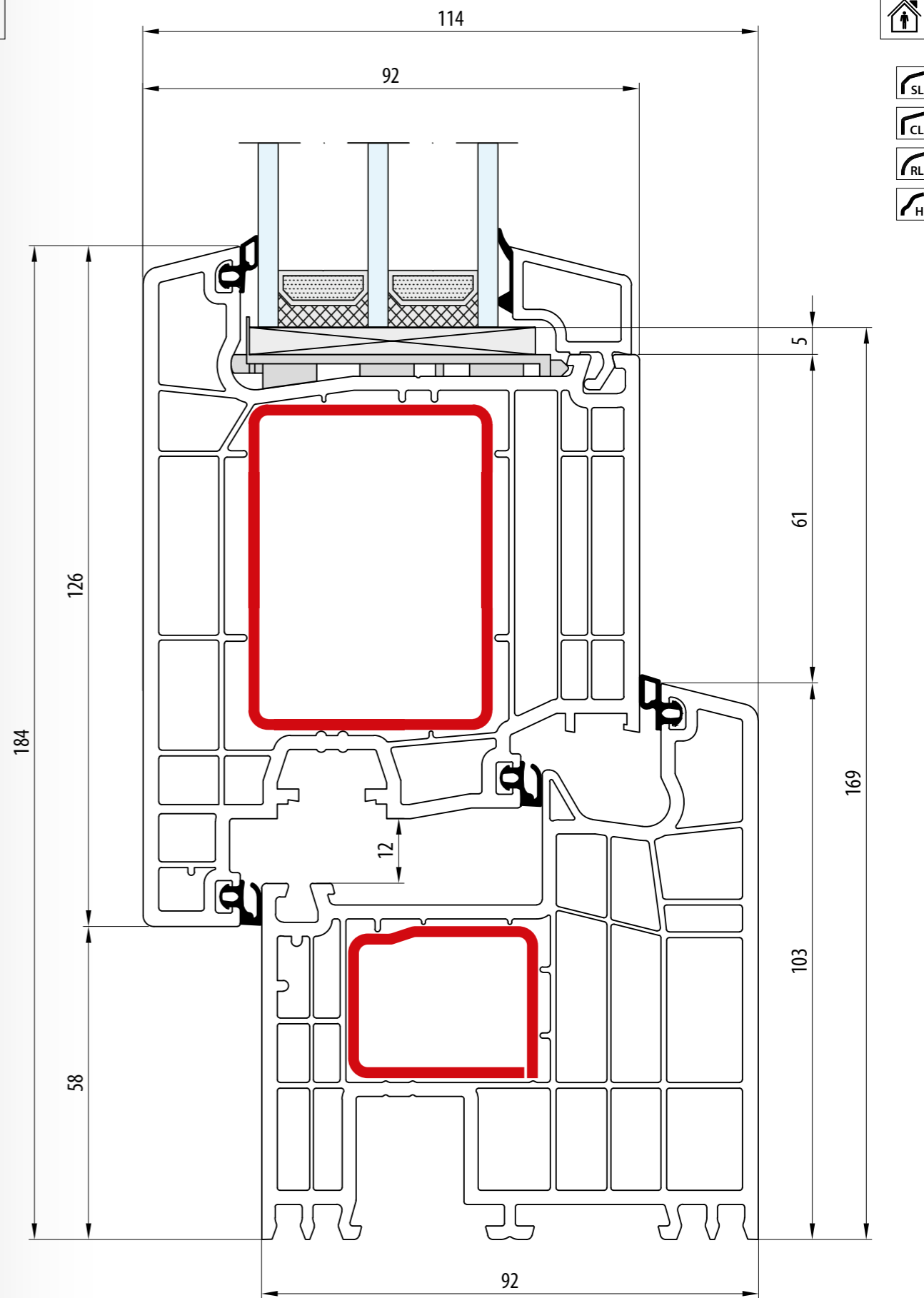
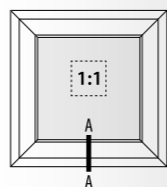

- Rama: 103 mm · Skrzydło: 126 mm
- Dormant: 103 mm · Vantail: 126 mm
- Frame: 103 mm · Sash: 126 mm
- Rahmen: 103 mm · Flügel: 126 mm
- Telaio: 103 mm · Anta: 126 mm

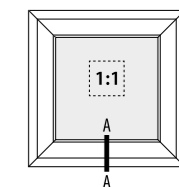

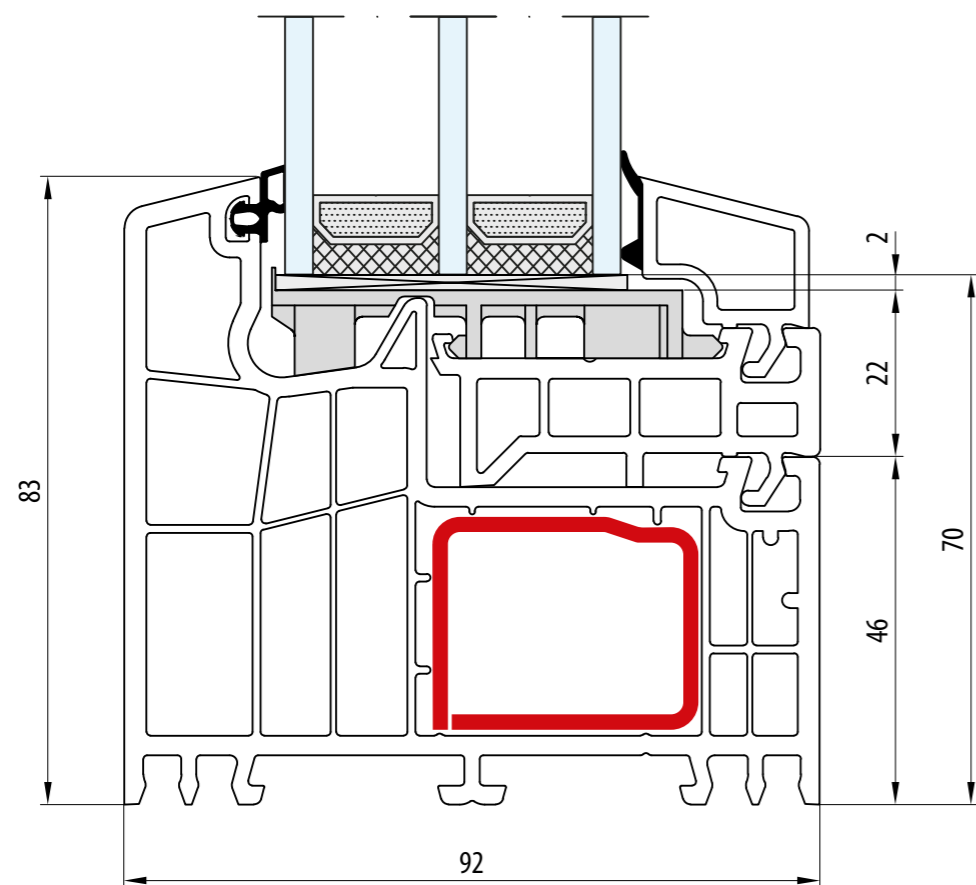

- Rama: 83 mm
- Dormant: 83 mm
- Frame: 83 mm
- Rahmen: 83 mm
- Telaio: 83 mm

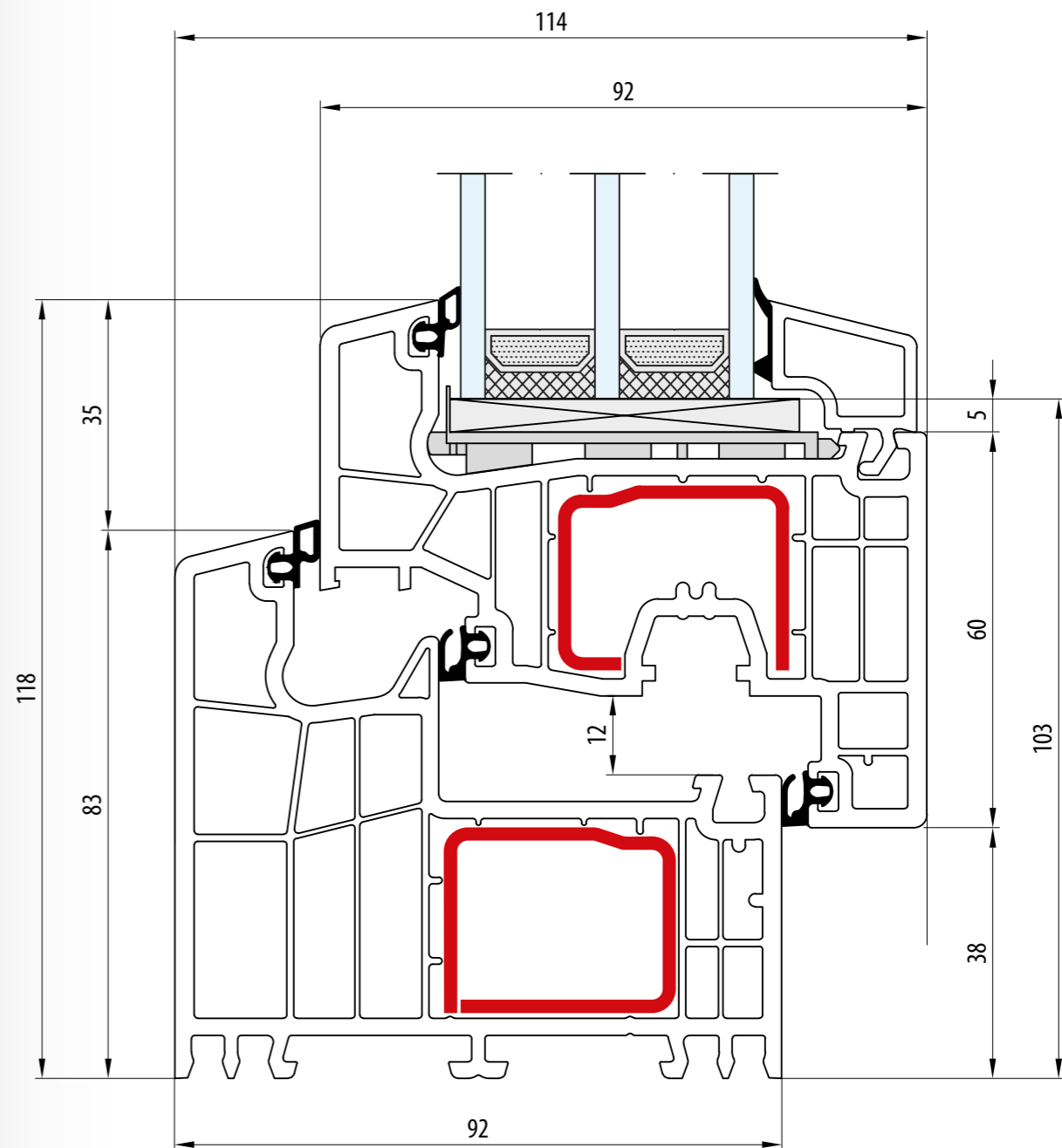
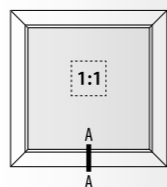

- Rama: 83 mm · Skrzydło: 80 mm
- Dormant: 83 mm · Vantail: 80 mm
- Frame: 83 mm · Sash: 80 mm
- Rahmen: 83 mm · Flügel: 80 mm
- Telaio: 83 mm · Anta: 80 mm

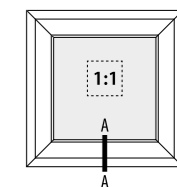

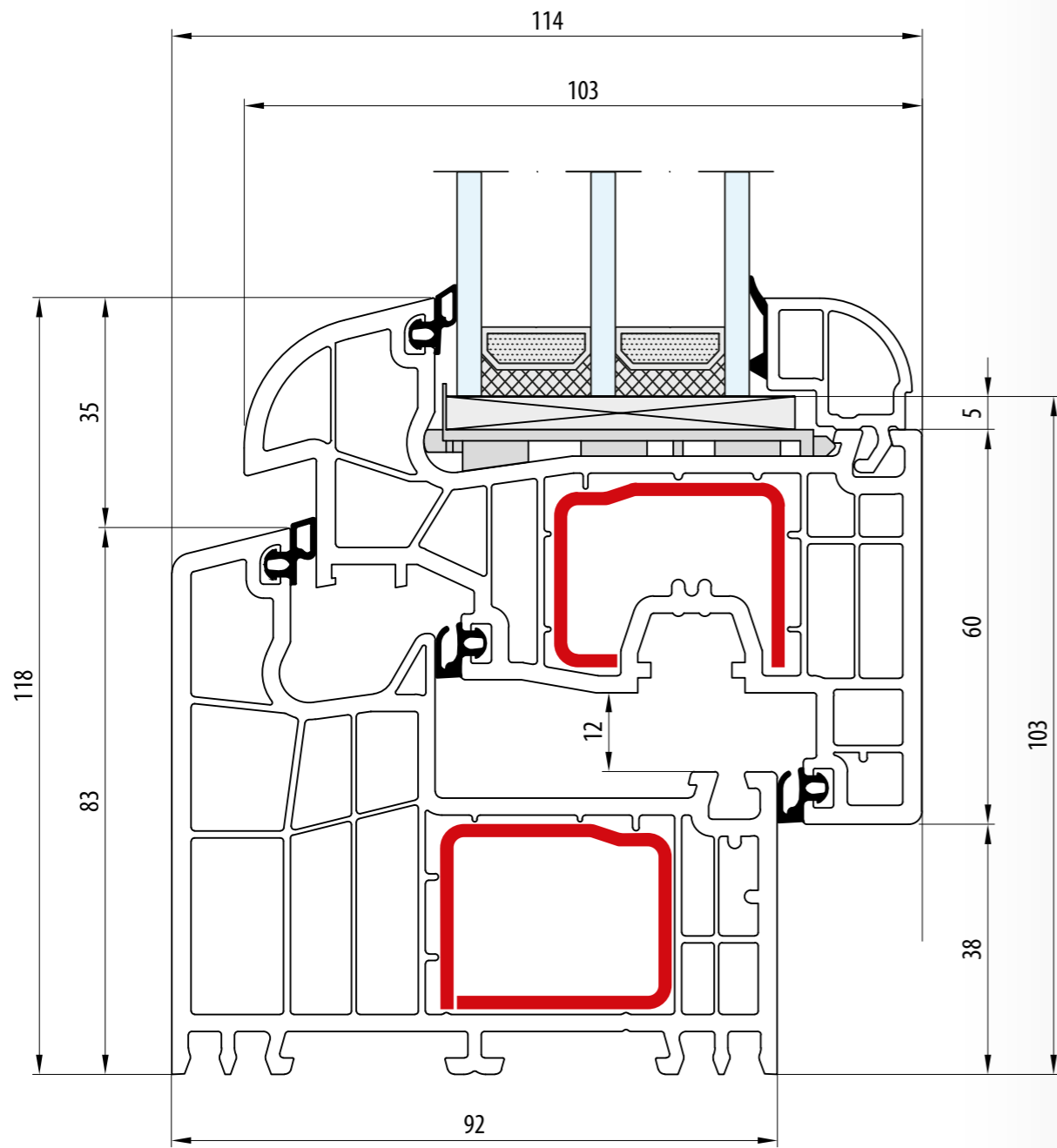

- Rama: 83 mm · Skrzydło: 80 mm
- Dormant: 83 mm · Vantail: 80 mm
- Frame: 83 mm · Sash: 80 mm
- Rahmen: 83 mm · Flügel: 80 mm
- Telaio: 83 mm · Anta: 80 mm

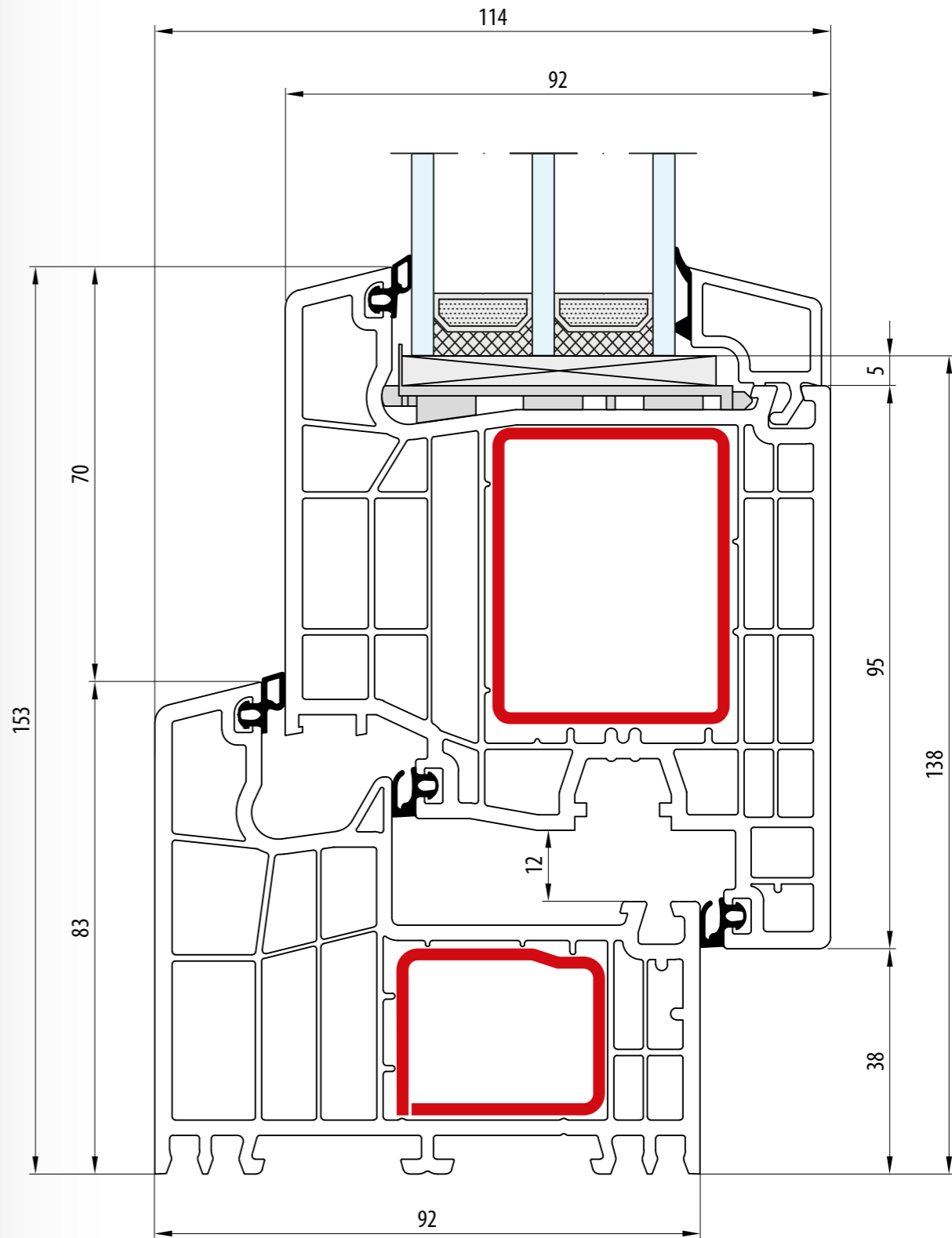
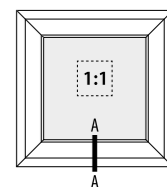
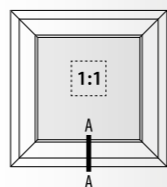

- Rama: 83 mm · Skrzydło: 115 mm
- Dormant: 83 mm · Vantail: 115 mm
- Frame: 83 mm · Sash: 115 mm
- Rahmen: 83 mm · Flügel: 115 mm
- Telaio: 83 mm · Anta: 115 mm

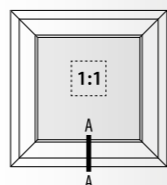
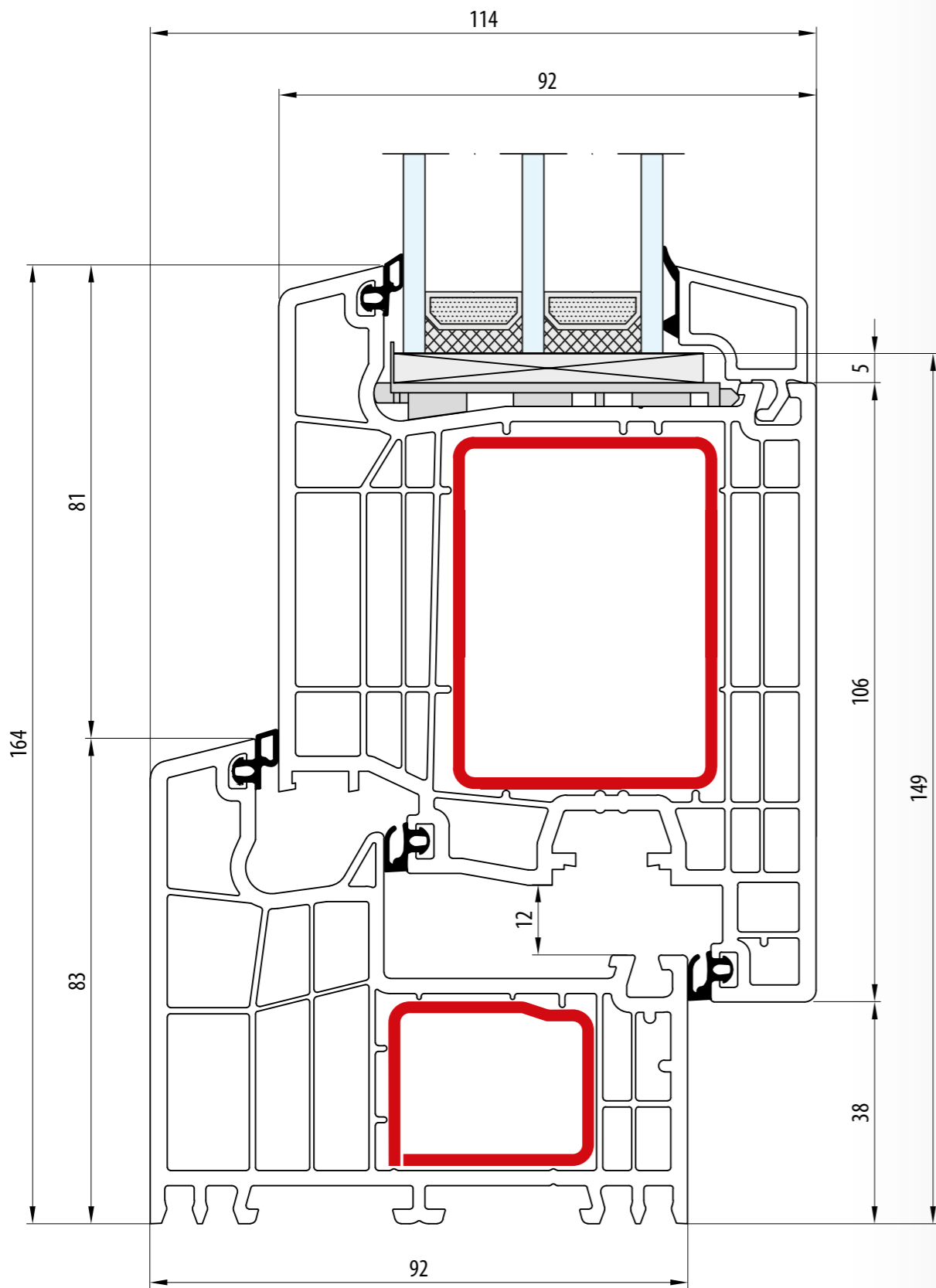

- Rama: 83 mm · Skrzydło: 126 mm
- Dormant: 83 mm · Vantail: 126 mm
- Frame: 83 mm · Sash: 126 mm
- Rahmen: 83 mm · Flügel: 126 mm
- Telaio: 83 mm · Anta: 126 mm

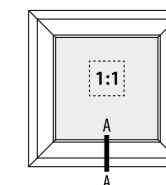
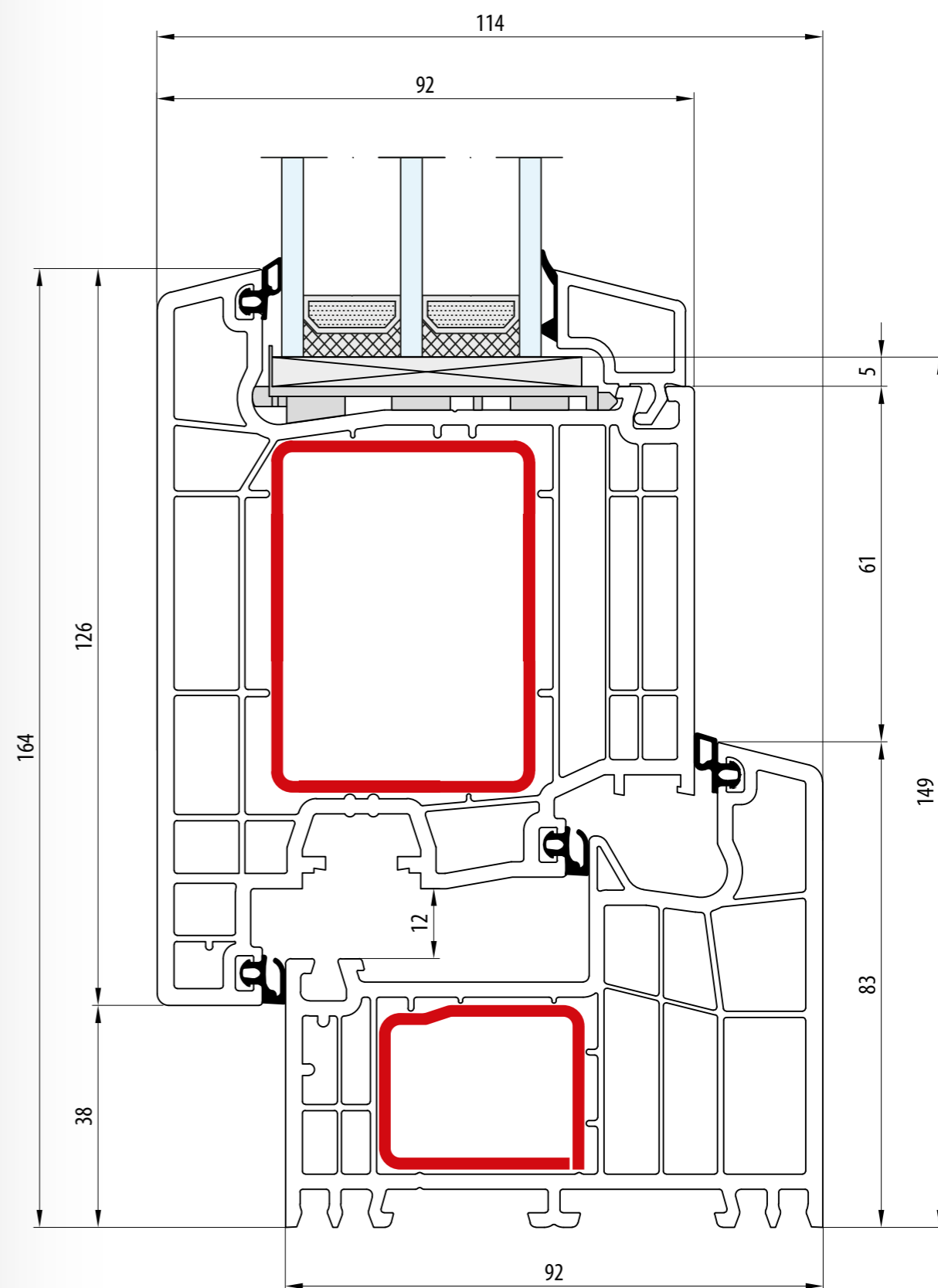

- Rama: 83 mm · Skrzydło: 126 mm
- Dormant: 83 mm · Vantail: 126 mm
- Frame: 83 mm · Sash: 126 mm
- Rahmen: 83 mm · Flügel: 126 mm
- Telaio: 83 mm · Anta: 126 mm

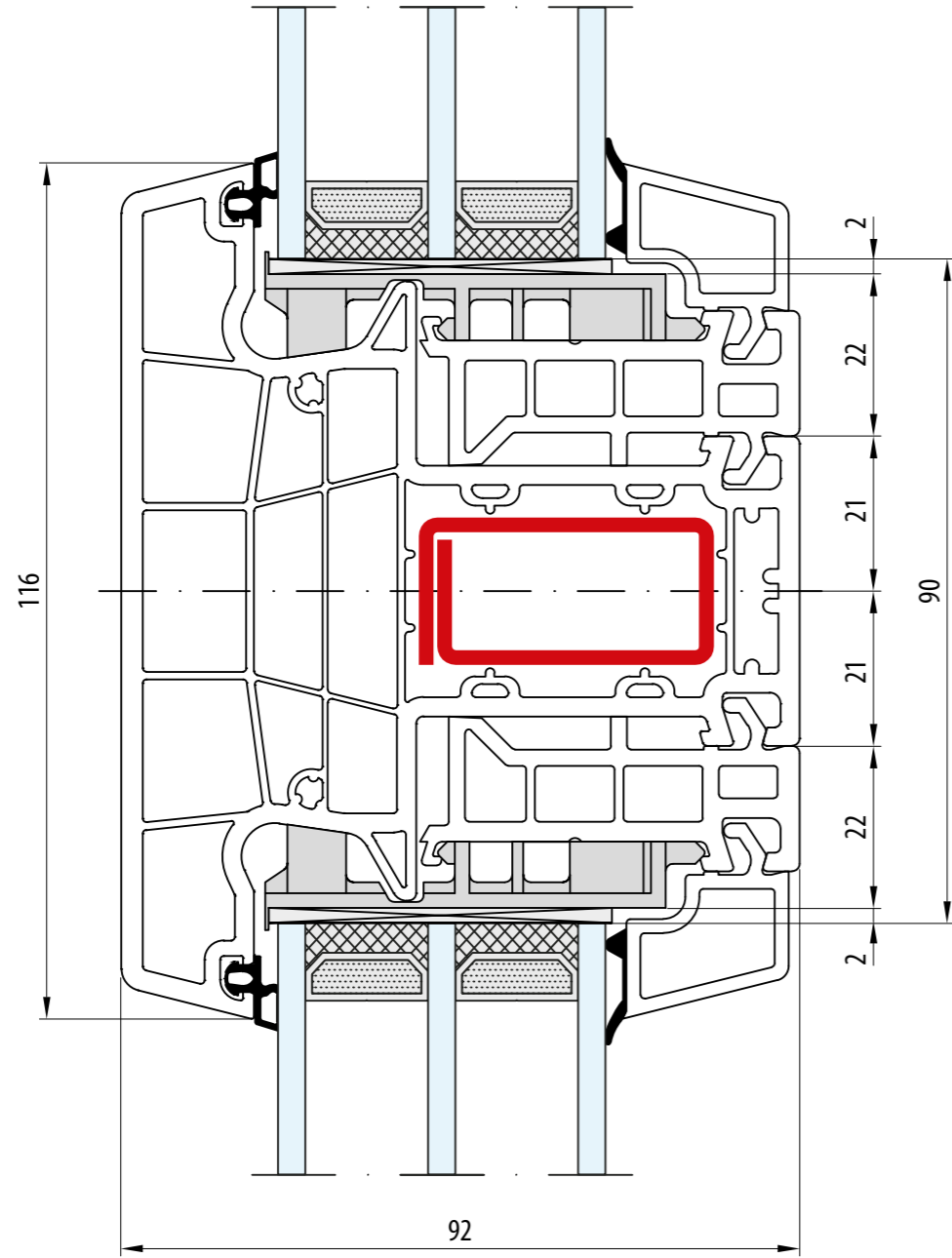

- Słupek stalowy: 116 mm
- Meneau fixe: 116 mm
- Fix post: 116 mm
- Festem Pfahl: 116 mm
- Montante fisso: 116 mm

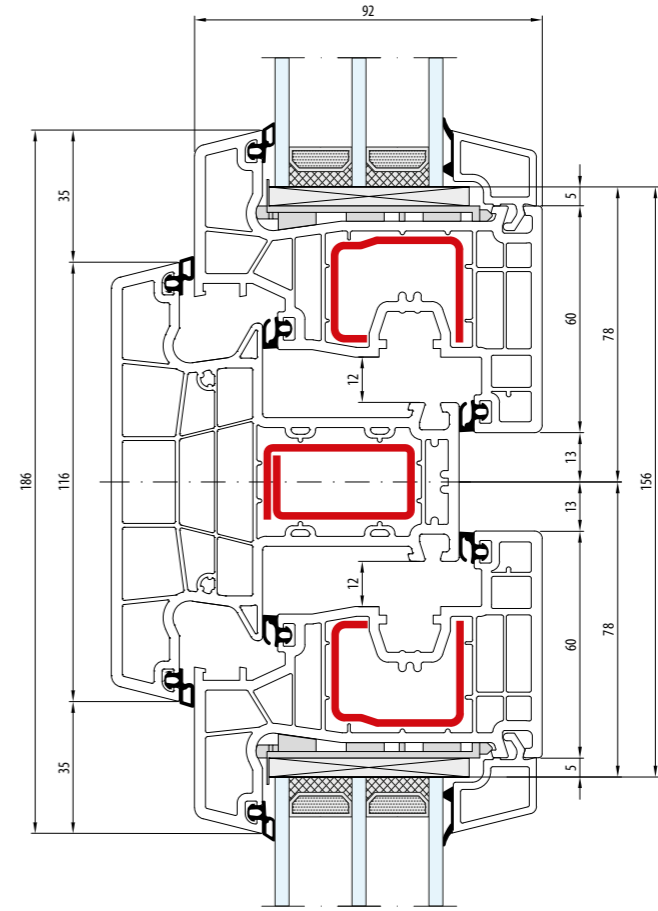
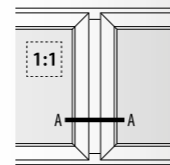

- Słupek stalowy: 116 mm · Skrzydło: 80 mm
- Meneau fixe: 116 mm · Vantail: 80 mm
- Fix post: 116 mm · Sash: 80 mm
- Festem Pfahl: 116 mm · Flügel: 80 mm
- Montante fisso: 116 mm · Anta: 80 mm

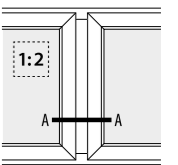

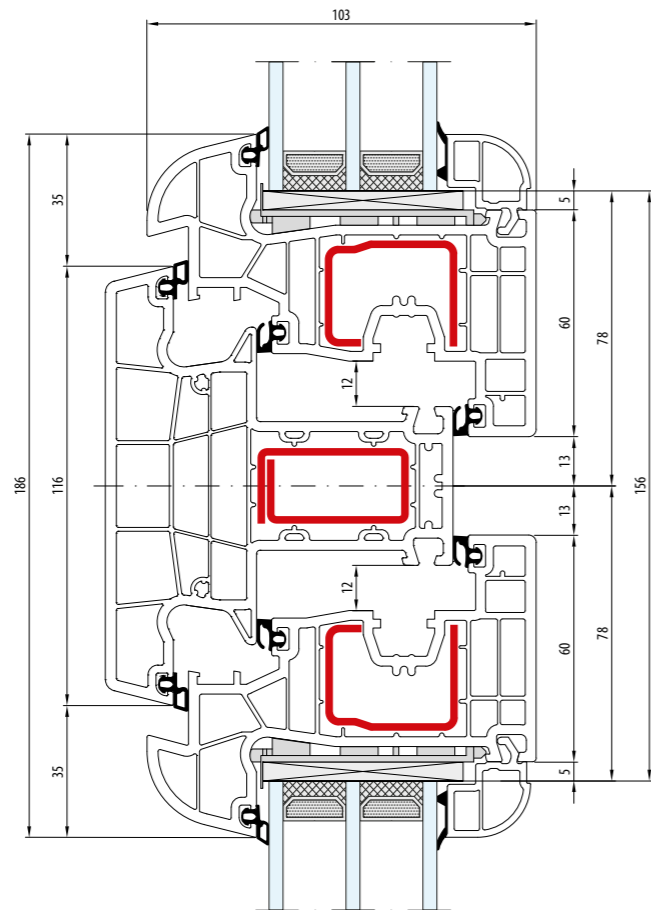

- Słupek stały: 116 mm · Skrzydło: 80 mm
- Meneau fixe: 116 mm · Vantail: 80 mm
- Fix post: 116 mm · Sash: 80 mm
- Festem Pfahl: 116 mm · Flügel: 80 mm
- Montante fisso: 116 mm · Anta: 80 mm

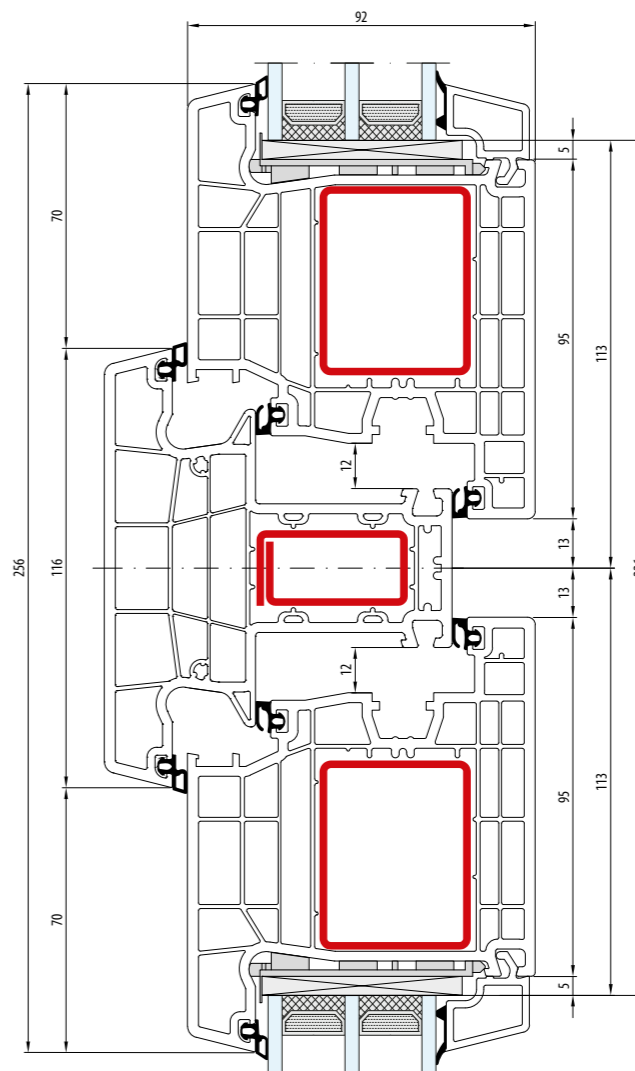
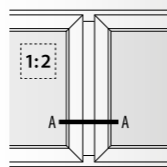

- Słupek stały: 116 mm · Skrzydło: 115 mm
- Meneau fixe: 116 mm · Vantail: 115 mm
- Fix post: 116 mm · Sash: 115 mm
- Festem Pfahl: 116 mm · Flügel: 115 mm
- Montante fisso: 116 mm · Anta: 115 mm

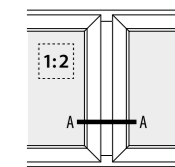

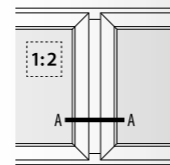
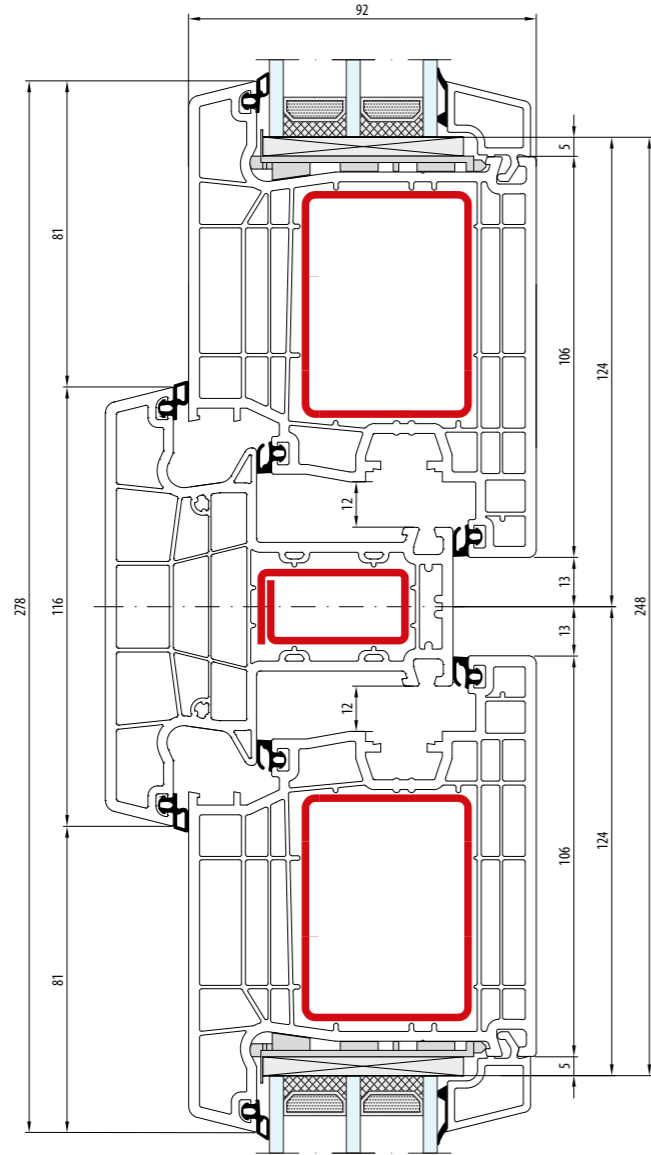

- Słupek stały: 116 mm · Skrzydło: 126 mm
- Meneau fixe: 116 mm · Vantail: 126 mm
- Fix post: 116 mm · Sash: 126 mm
- Festem Pfahl: 116 mm · Flügel: 126 mm
- Montante fisso: 116 mm · Anta: 126 mm

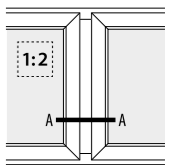
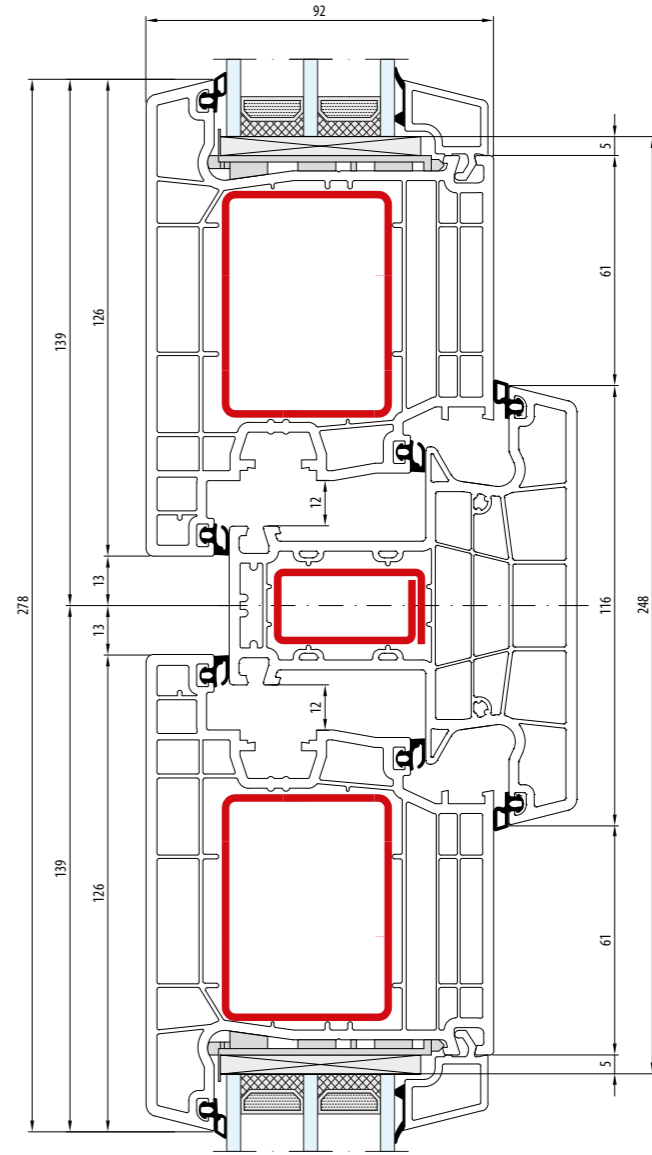

- Słupek stały: 116 mm · Skrzydło: 126 mm
- Meneau fixe: 116 mm · Vantail: 126 mm
- Fix post: 116 mm · Sash: 126 mm
- Festem Pfahl: 116 mm · Flügel: 126 mm
- Montante fisso: 116 mm · Anta: 126 mm

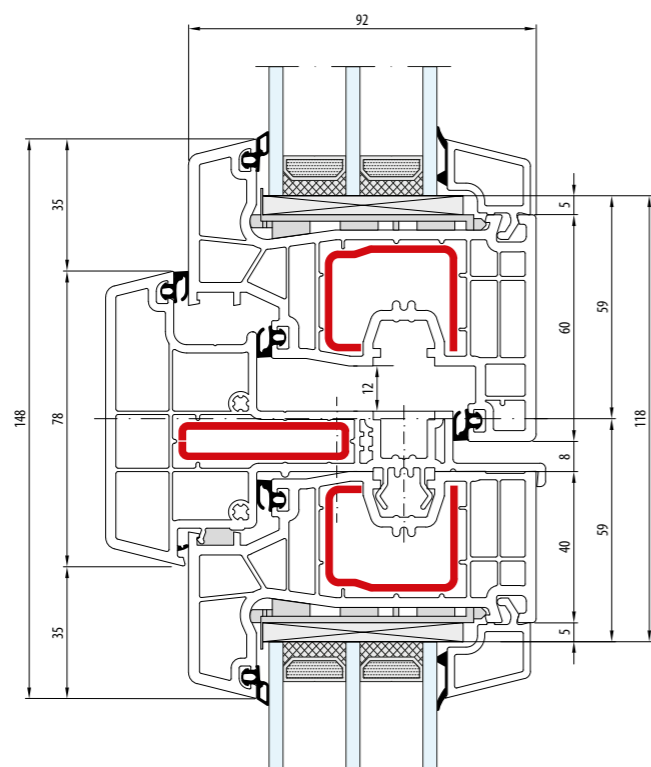

- Słupek ruchomy: 78 mm · Skrzydło: 80 mm / 60 mm
- Meneau mobile: 78 mm · Vantail: 80 mm / 60 mm
- Movable post: 78 mm · Sash: 80 mm / 60 mm
- Stulp: 78 mm · Flügel: 80 mm / 60 mm
- Montante mobile: 78 mm · Anta: 80 mm / 60 mm

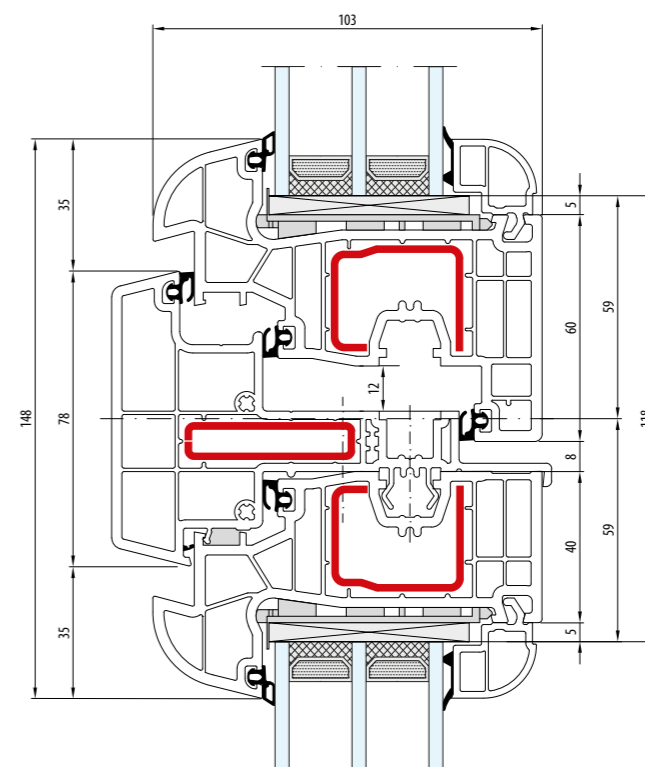
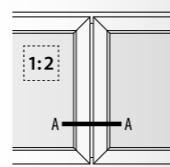

- Słupek ruchomy: 78 mm · Skrzydło: 80 mm / 60 mm
- Meneau mobile: 78 mm · Vantail: 80 mm / 60 mm
- Movable post: 78 mm · Sash: 80 mm / 60 mm
- Stulp: 78 mm · Flügel: 80 mm / 60 mm
- Montante mobile: 78 mm · Anta: 80 mm / 60 mm

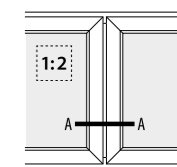

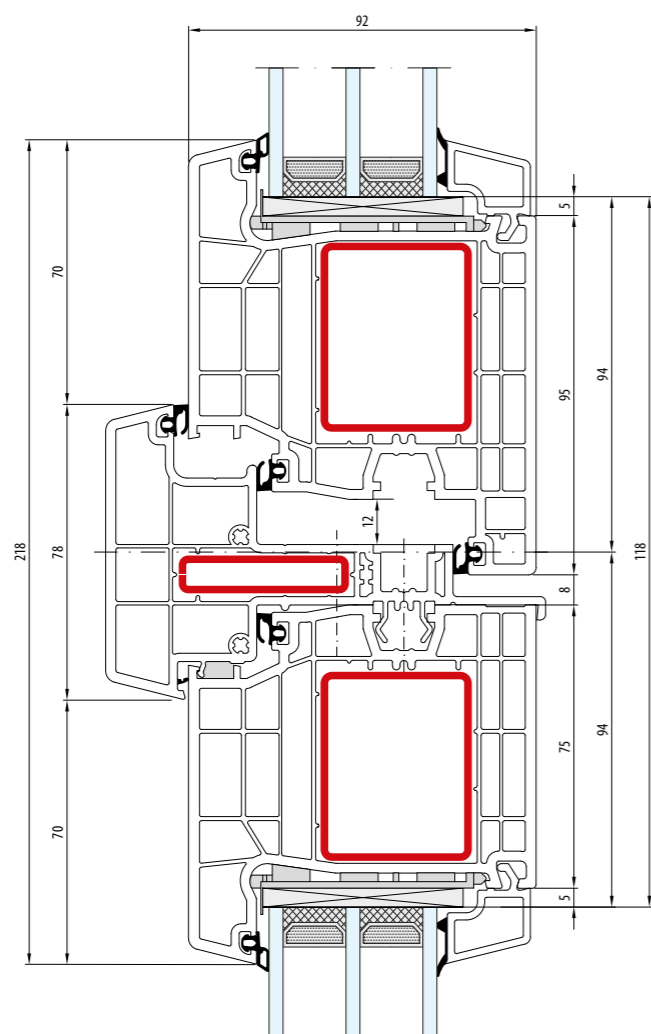

- Słupek ruchomy: 78 mm · Skrzydło: 115 mm / 95 mm
- Meneau mobile: 78 mm · Vantail: 115 mm / 95 mm
- Movable post: 78 mm · Sash: 115 mm / 95 mm
- Stulp: 78 mm · Flügel: 115 mm / 95 mm
- Montante mobile: 78 mm · Anta: 115 mm / 95 mm

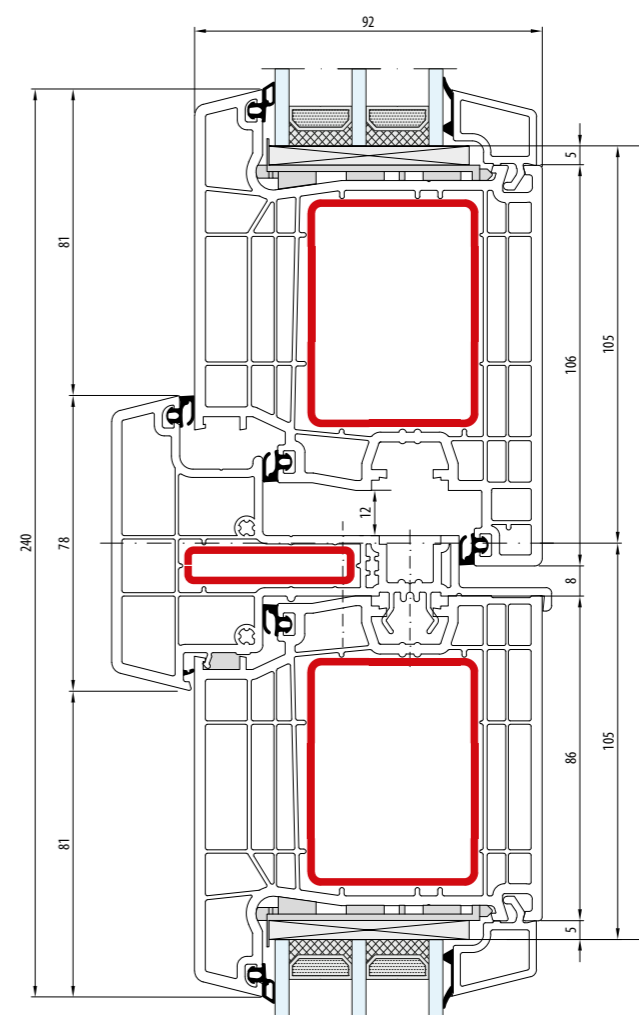
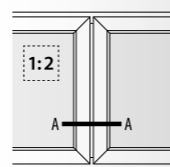

- Słupek ruchomy: 78 mm · Skrzydło: 126 mm / 106 mm
- Meneau mobile: 78 mm · Vantail: 126 mm / 106 mm
- Movable post: 78 mm · Sash: 126 mm / 106 mm
- Stulp: 78 mm · Flügel: 126 mm / 106 mm
- Montante mobile: 78 mm · Anta: 126 mm / 106 mm

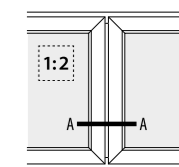

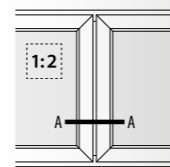
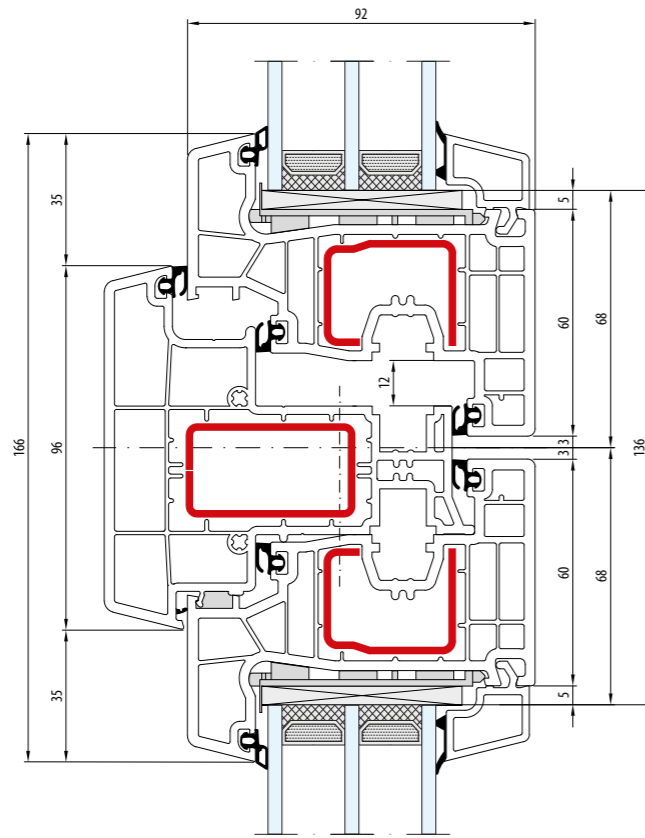

- Słupek ruchomy: 96 mm · Skrzydło: 80 mm
- Meneau mobile: 96 mm · Vantail: 80 mm
- Movable post: 96 mm · Sash: 80 mm
- Stulp: 96 mm · Flügel: 80 mm
- Montante mobile: 96 mm · Anta: 80 mm

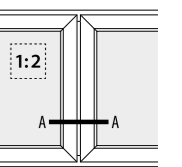
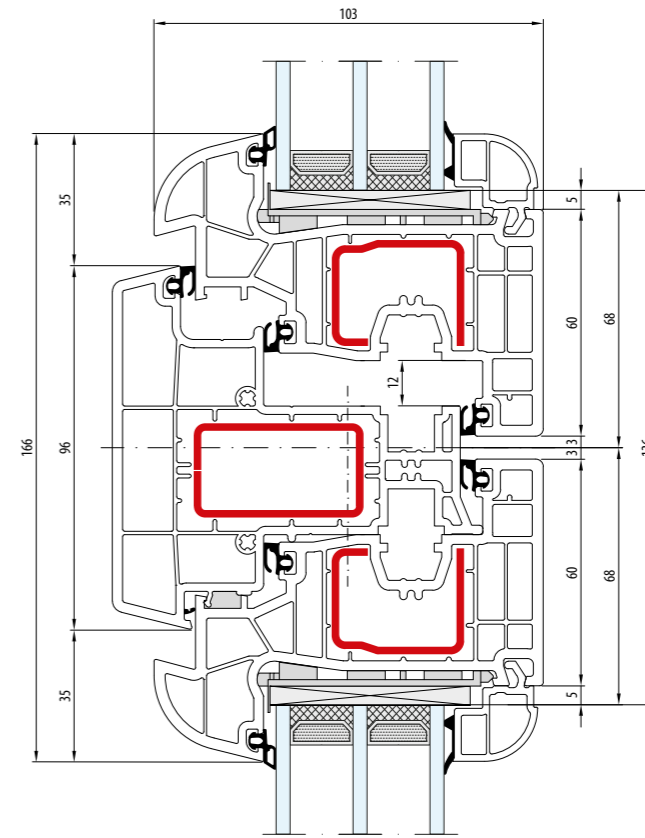

- Słupek ruchomy: 96 mm · Skrzydło: 80 mm
- Meneau mobile: 96 mm · Vantail: 80 mm
- Movable post: 96 mm · Sash: 80 mm
- Stulp: 96 mm · Flügel: 80 mm
- Montante mobile: 96 mm · Anta: 80 mm

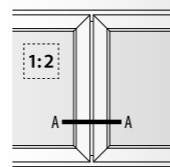
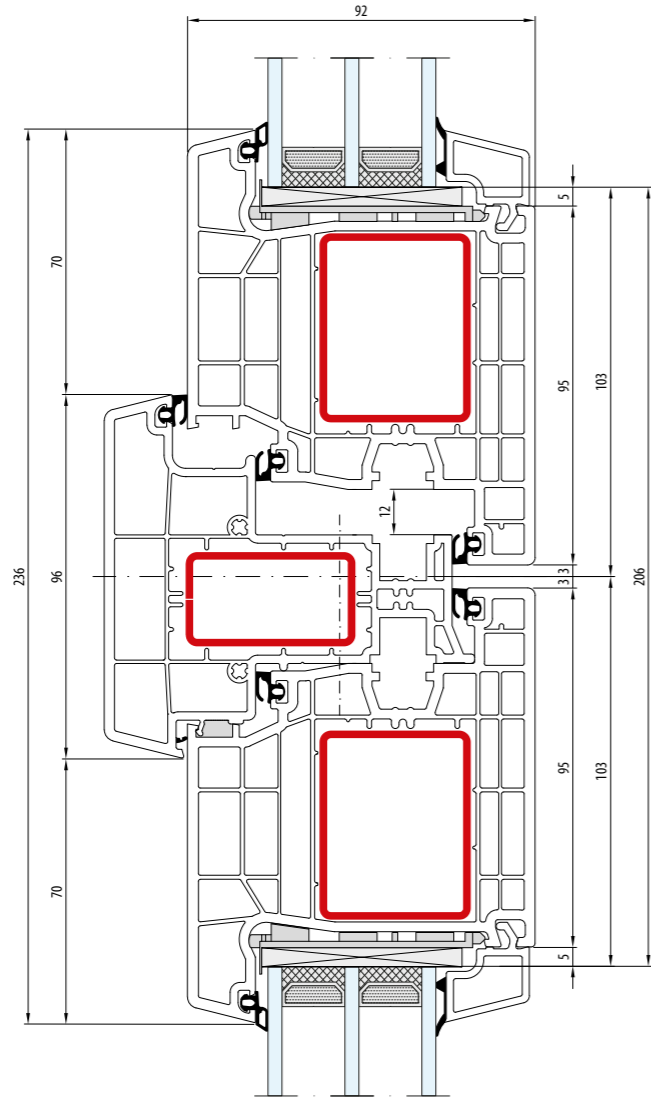

- Słupek ruchomy: 96 mm · Skrzydło: 115 mm
- Meneau mobile: 96 mm · Vantail: 115 mm
- Movable post: 96 mm · Sash: 115 mm
- Stulp: 96 mm · Flügel: 115 mm
- Montante mobile: 96 mm · Anta: 115 mm

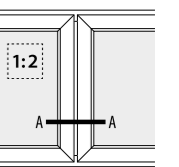
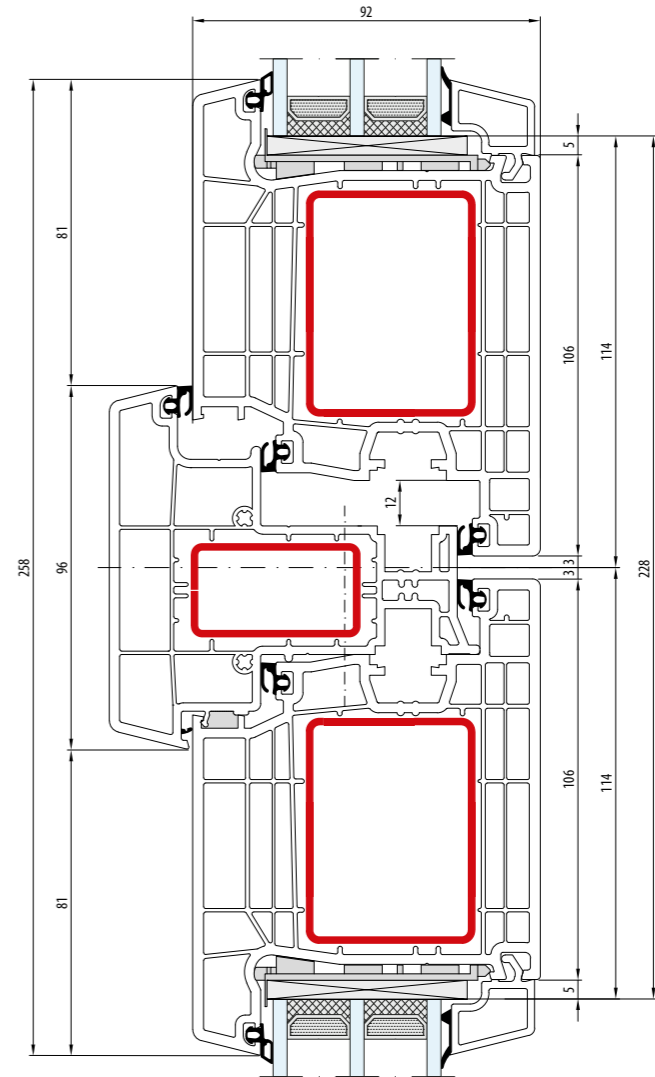

- Słupek ruchomy: 96 mm · Skrzydło: 126 mm
- Meneau mobile: 96 mm · Vantail: 126 mm
- Movable post: 96 mm · Sash: 126 mm
- Stulp: 96 mm · Flügel: 126 mm
- Montante mobile: 96 mm · Anta: 126 mm

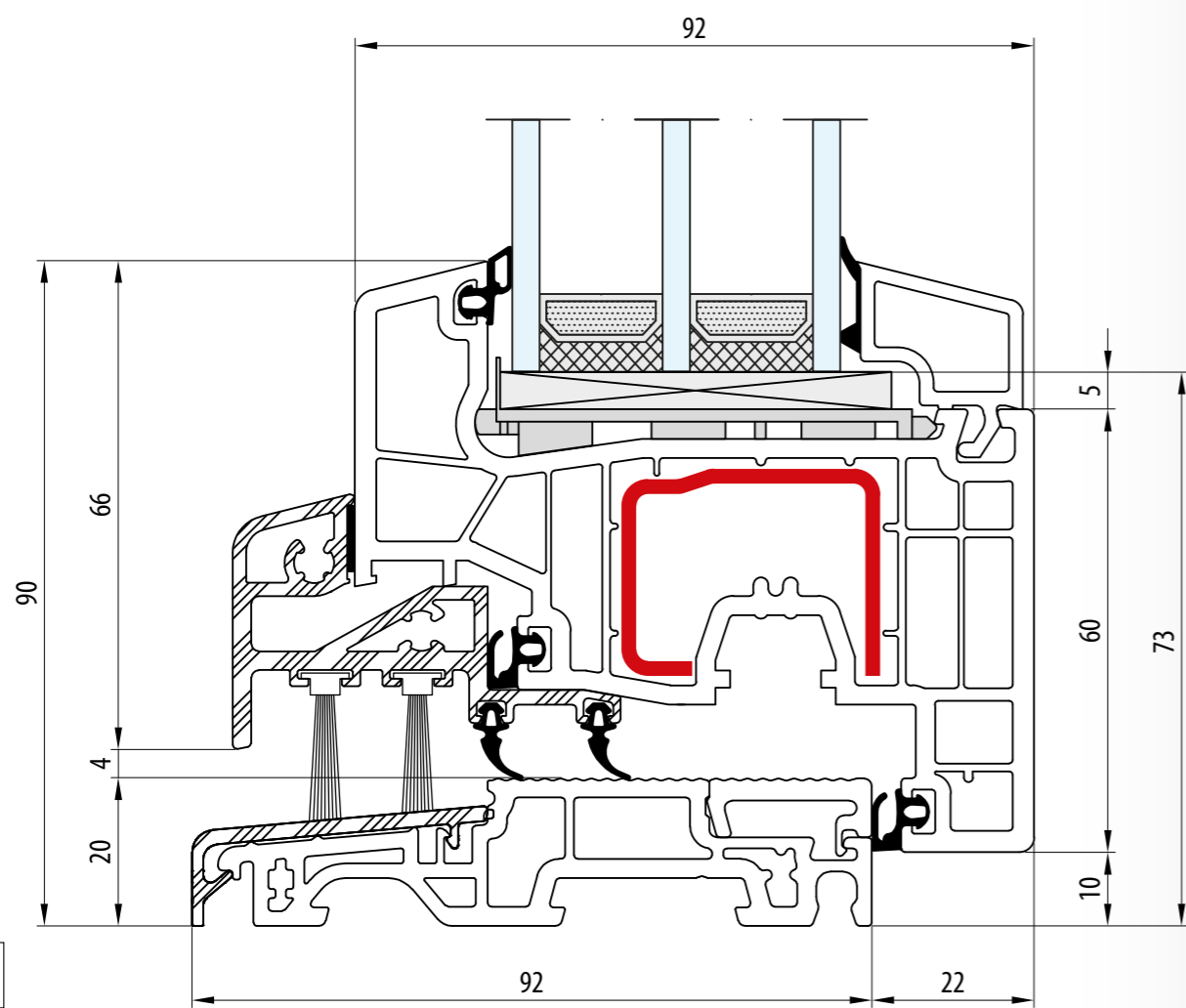

- Próg: 20 mm · Skrzydło: 80 mm
- Seuil: 20 mm · Vantail: 80 mm
- Threshold: 20 mm · Sash: 80 mm
- Schwelle: 20 mm · Flügel: 80 mm
- Soglia: 20 mm · Anta: 80 mm

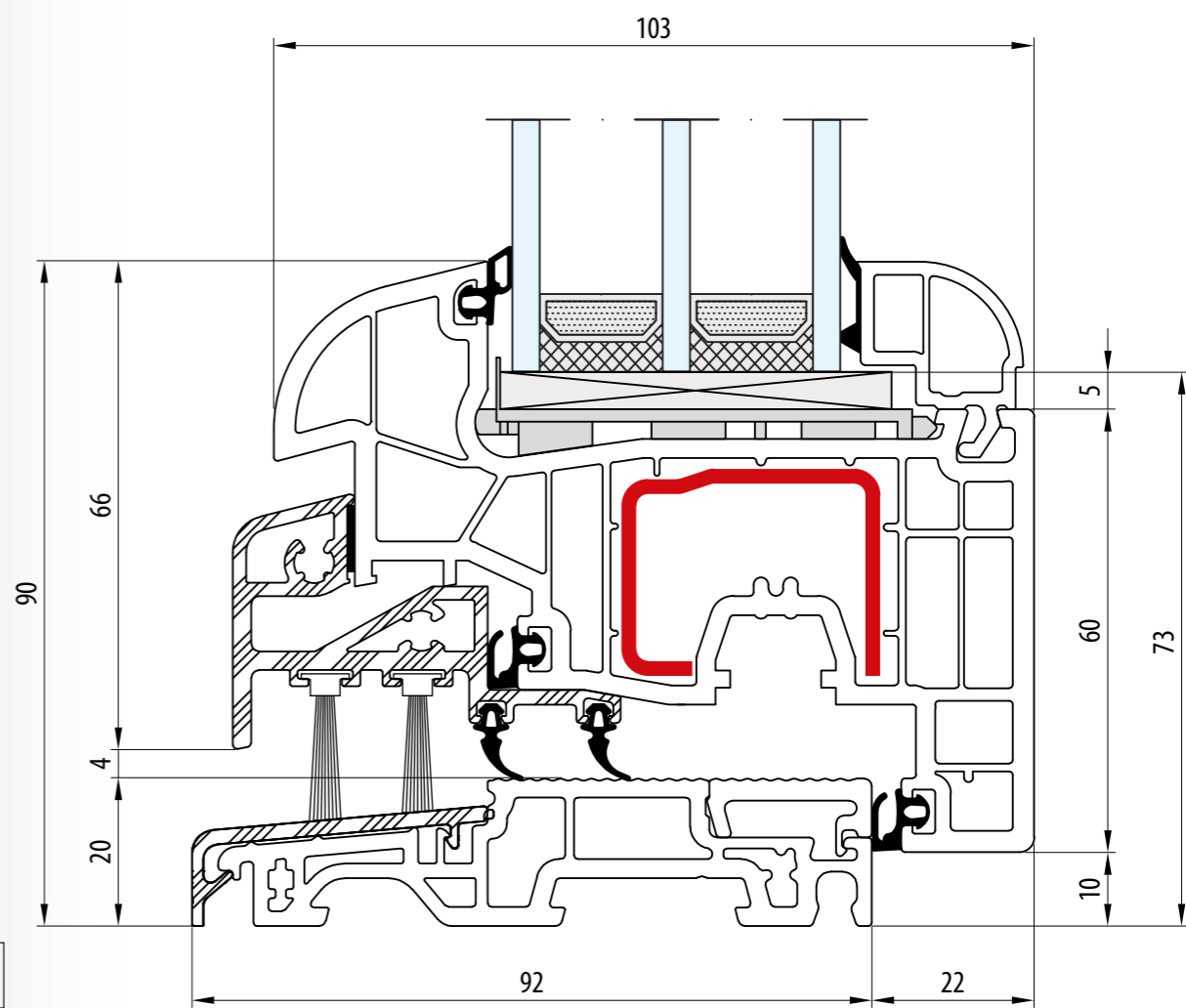
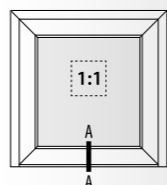

- Próg: 20 mm · Skrzydło: 80 mm
- Seuil: 20 mm · Vantail: 80 mm
- Threshold: 20 mm · Sash: 80 mm
- Schwelle: 20 mm · Flügel: 80 mm
- Soglia: 20 mm · Anta: 80 mm

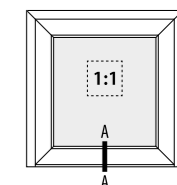

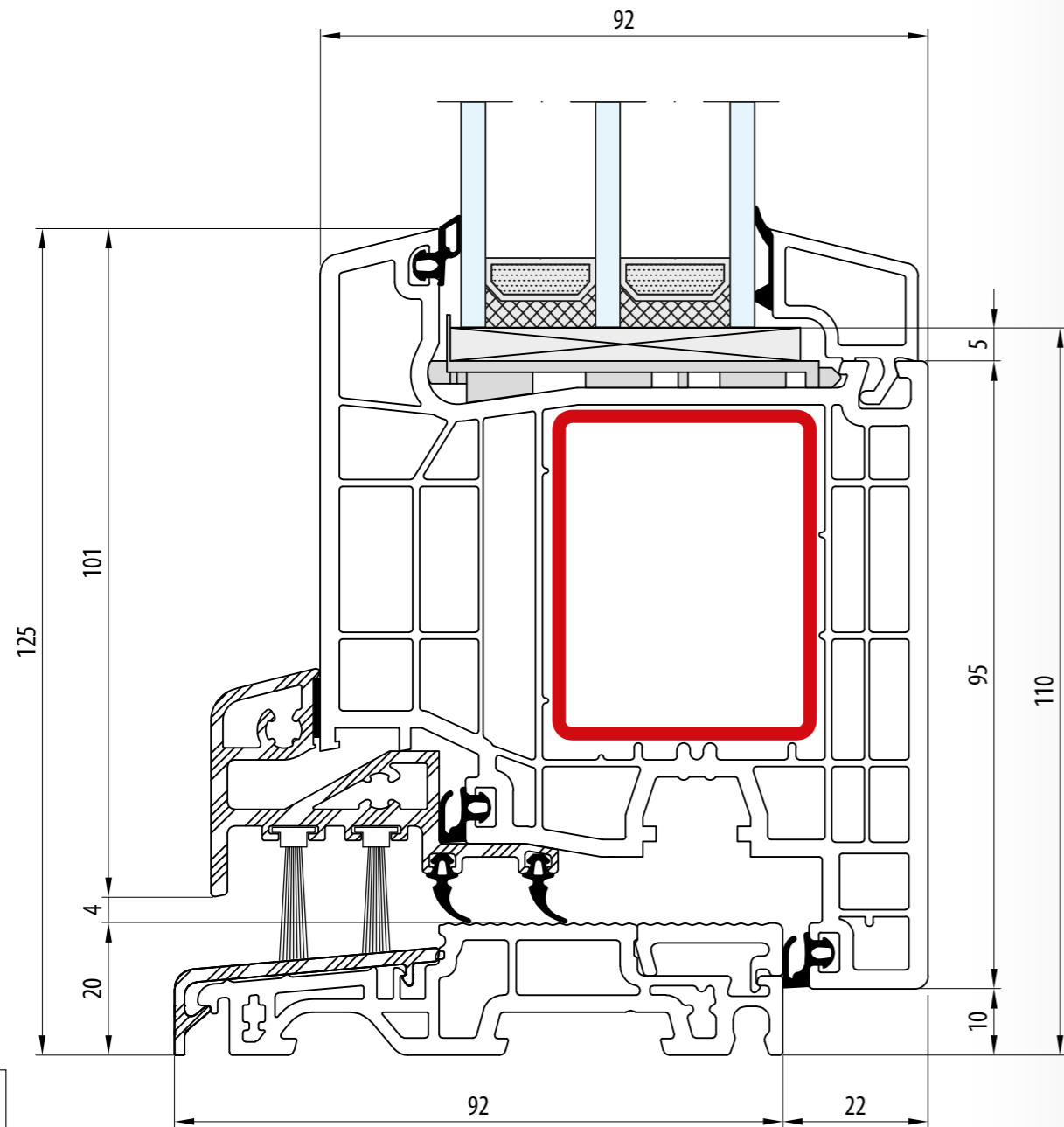

- Próg: 20 mm · Skrzydło: 115 mm
- Seuil: 20 mm · Vantail: 115 mm
- Threshold: 20 mm · Sash: 115 mm
- Schwelle: 20 mm · Flügel: 115 mm
- Soglia: 20 mm · Anta: 115 mm

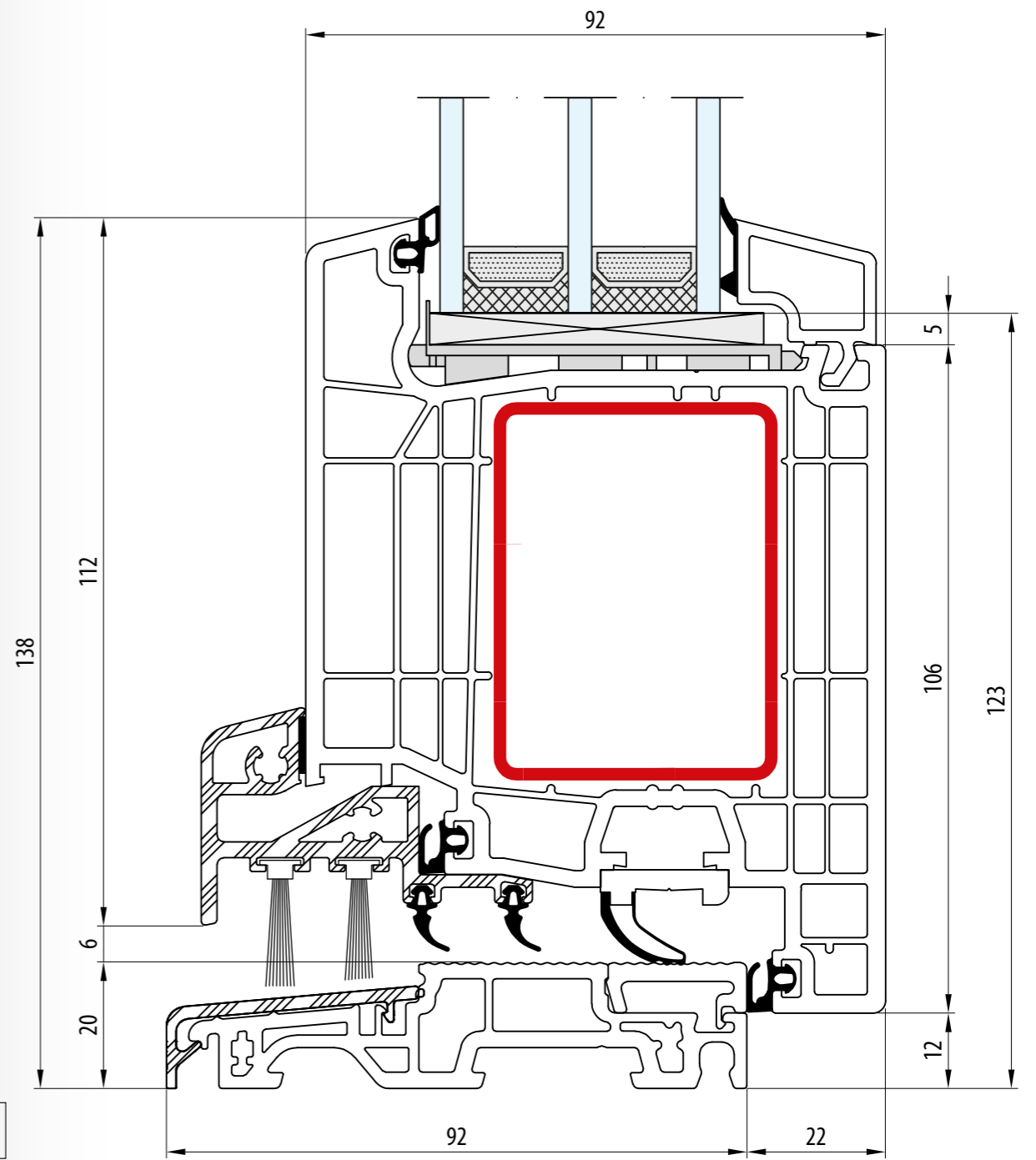
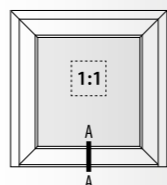

- Próg: 20 mm · Skrzydło: 126 mm
- Seuil: 20 mm · Vantail: 126 mm
- Threshold: 20 mm · Sash: 126 mm
- Schwelle: 20 mm · Flügel: 126 mm
- Soglia: 20 mm · Anta: 126 mm

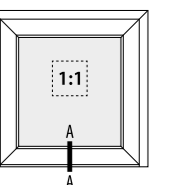

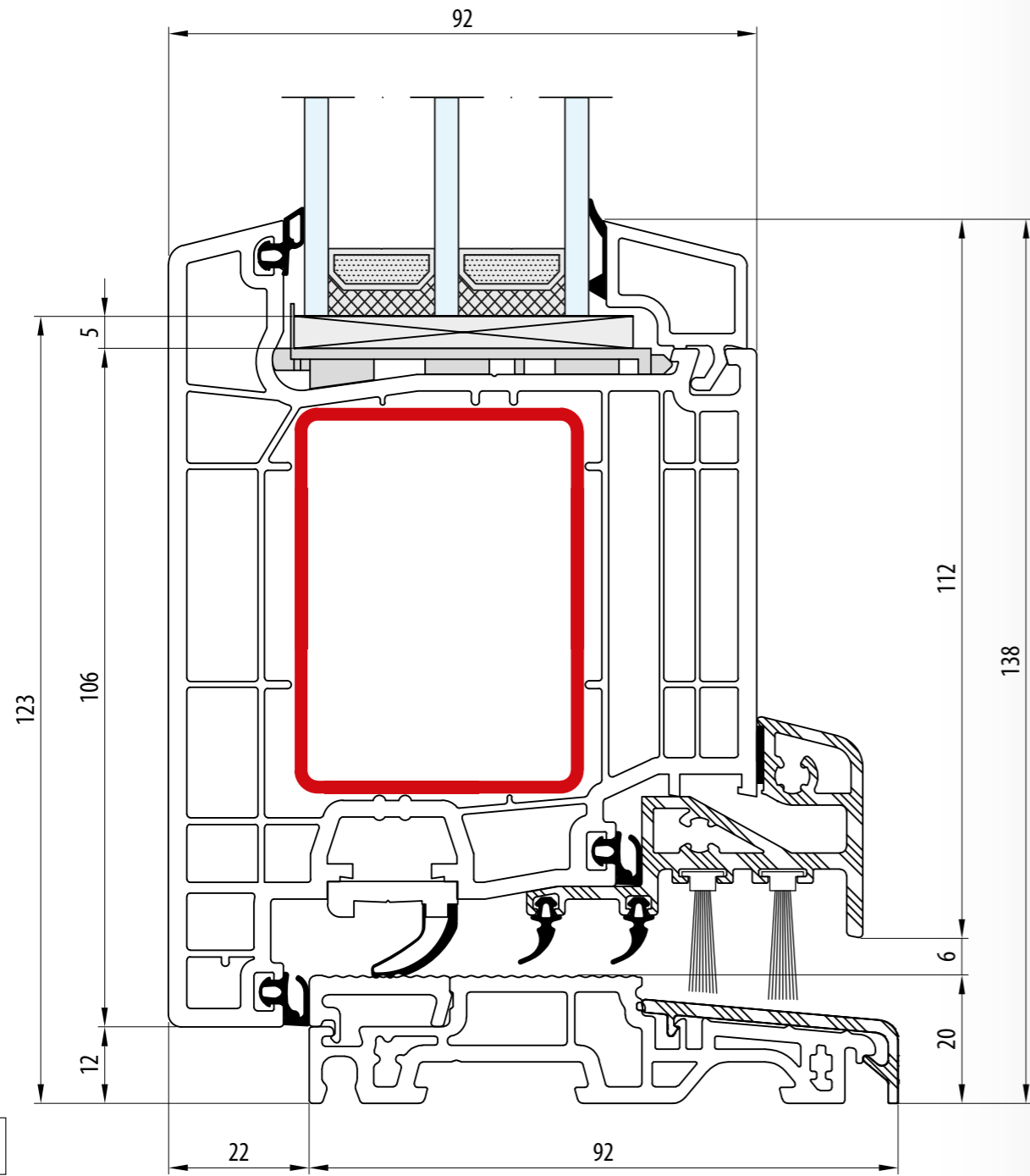

- Próg: 20 mm · Skrzydło: 115 mm
- Seuil: 20 mm · Vantail: 115 mm
- Threshold: 20 mm · Sash: 115 mm
- Schwelle: 20 mm · Flügel: 115 mm
- Soglia: 20 mm · Anta: 115 mm

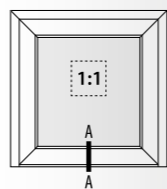

EVOLUTIONDRIVE SF

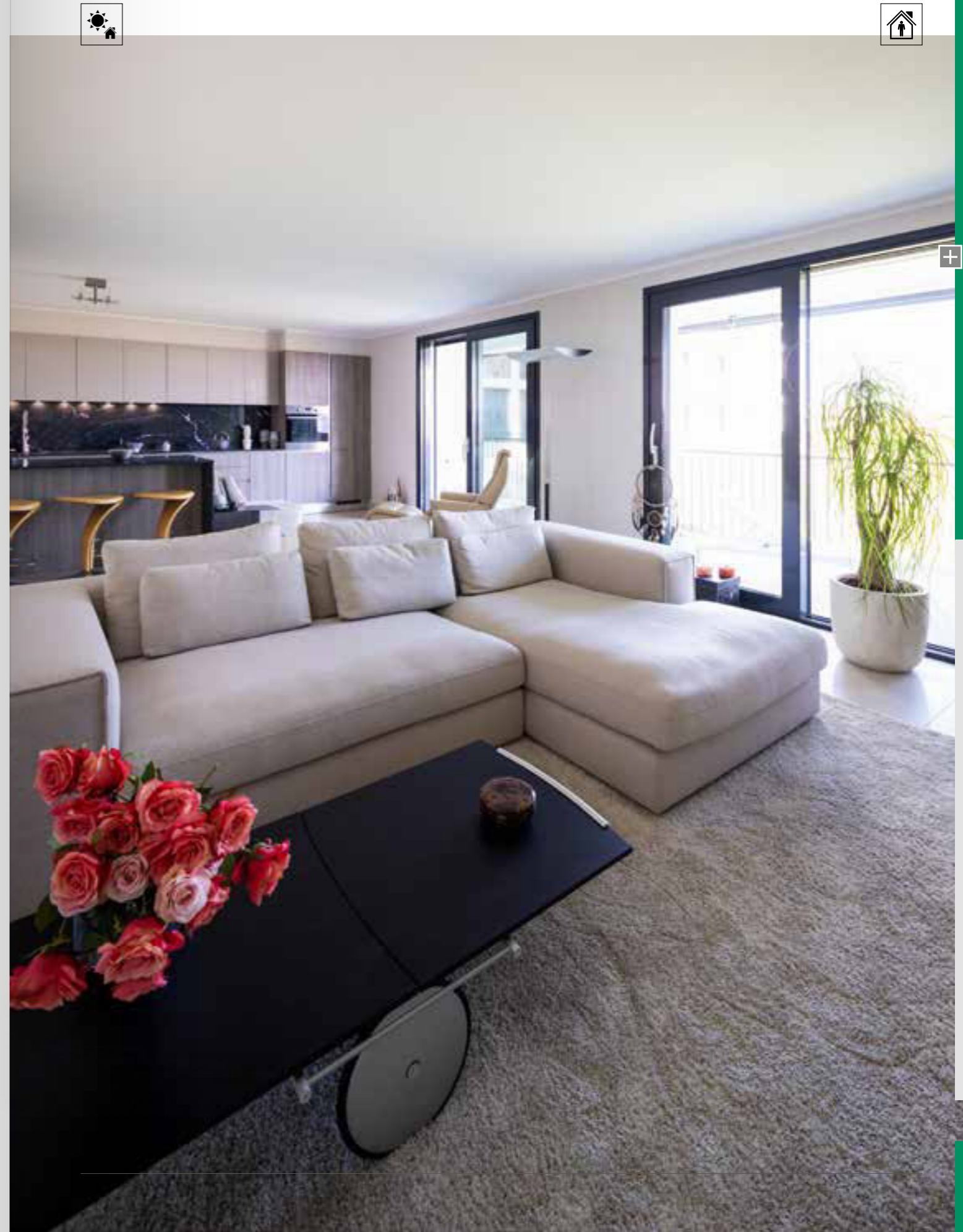
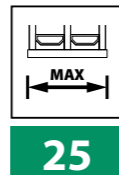
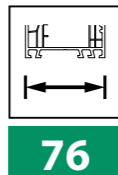
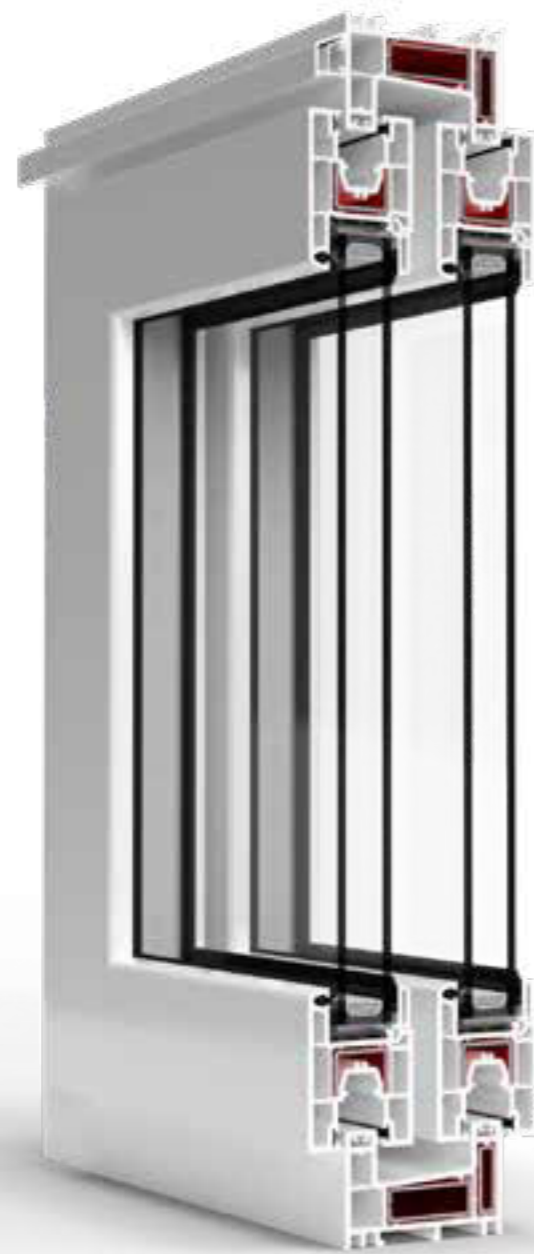

EVOLUTIONDRIVE SF

EVOLUTIONDRIVE 82

EVOLUTIONDRIVE SF

EVOLUTIONDRIVE 82

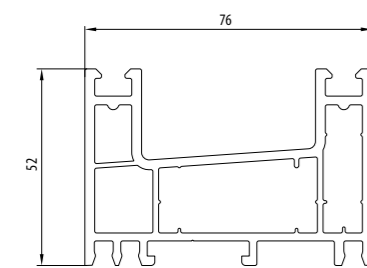



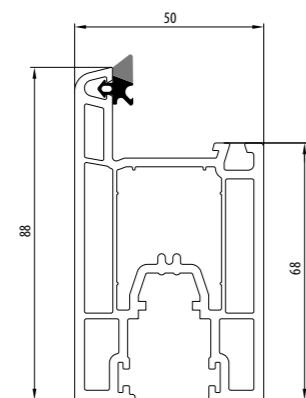

600128

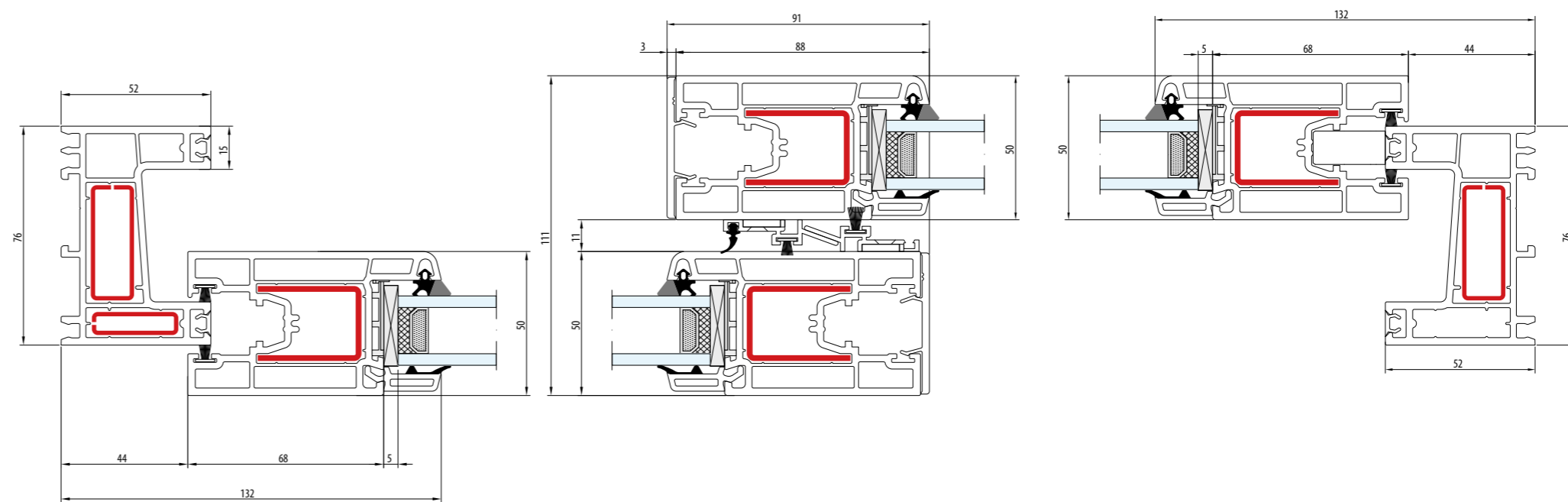

601138



-  Schemat A - Przekrój poziomy · Rama: 52 mm · Skrzydło: 88 mm
-  Schéma A - Coupe horizontale · Dormant: 52 mm · Vantail: 88 mm
-  Schema A - Doorsnede horizontaal · Frame: 52 mm · Sash: 88 mm
-  Schema A - Wagerechter Schnitt · Rahmen: 52 mm · Flügel: 88 mm
-  Schema A - Sezione orizzontale · Telaio: 52 mm · Anta: 88 mm

1:2

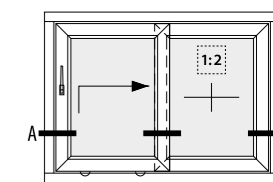

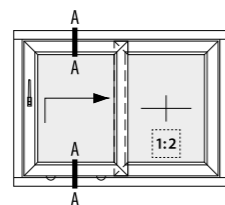
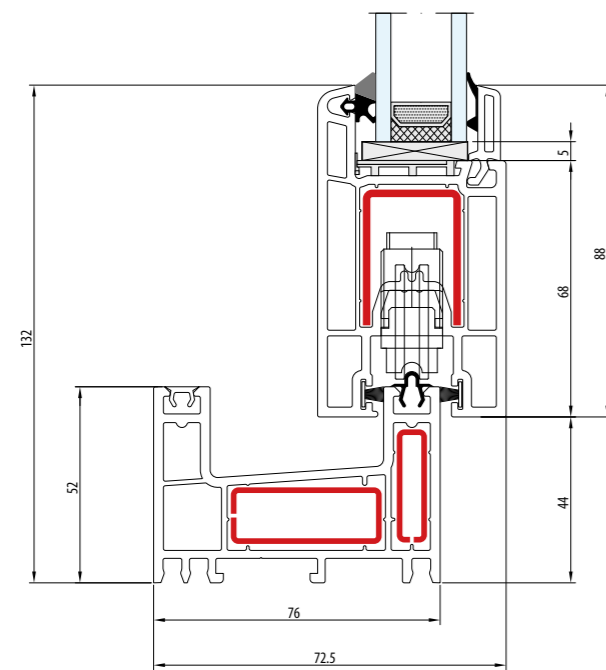
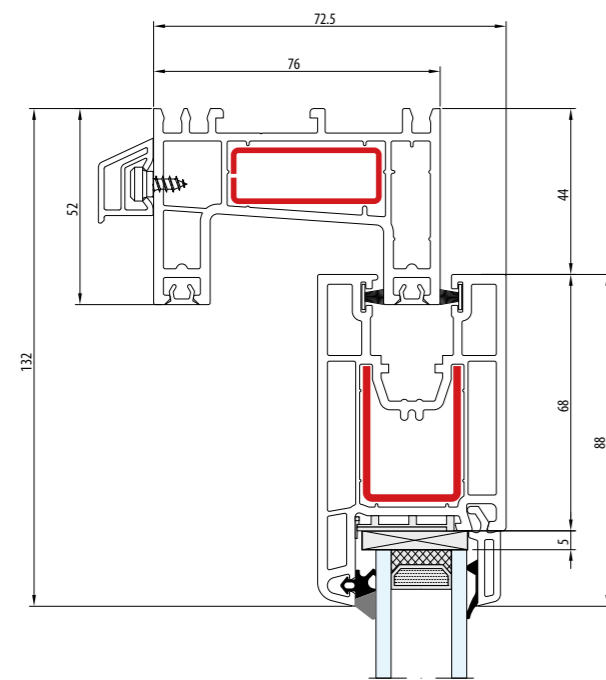

- Schemat A - Przekrój pionowy · Rama: 52 mm · Skrzydło: 88 mm
- Schéma A - Coupe verticale · Dormant: 52 mm · Vantail: 88 mm
- Schema A - Doorsnede verticaal · Frame: 52 mm · Sash: 88 mm
- Schema A - Senkrechter Schnitt · Rahmen: 52 mm · Flügel: 88 mm
- Schema A - Sezione verticale · Telaio: 52 mm · Anta: 88 mm

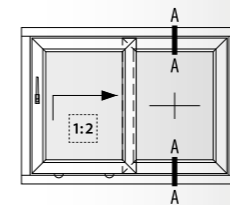
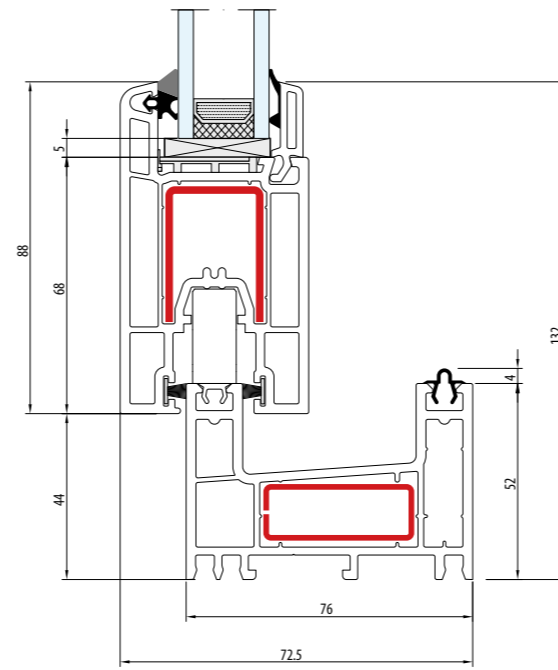
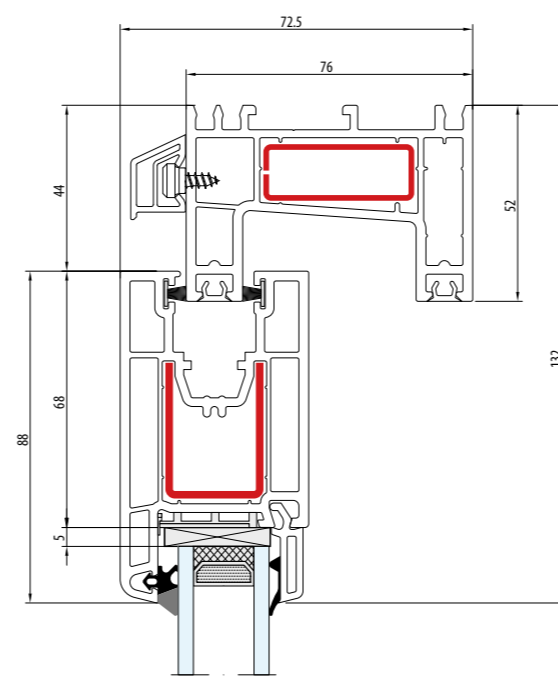

- Schemat A - Przekrój pionowy · Rama: 52 mm · Skrzydło: 88 mm
- Schéma A - Coupe verticale · Dormant: 52 mm · Vantail: 88 mm
- Schema A - Doorsnede verticaal · Frame: 52 mm · Sash: 88 mm
- Schema A - Senkrechter Schnitt · Rahmen: 52 mm · Flügel: 88 mm
- Schema A - Sezione verticale · Telaio: 52 mm · Anta: 88 mm

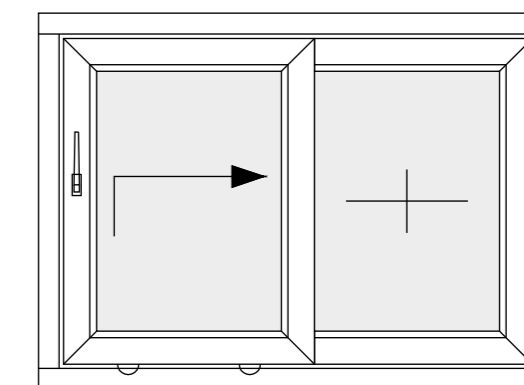

A

- Schemat
- Schéma
- Schema
- Schema
- Schema

EVOLUTIONDRIVE 82

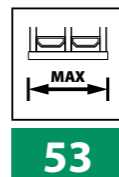
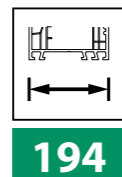
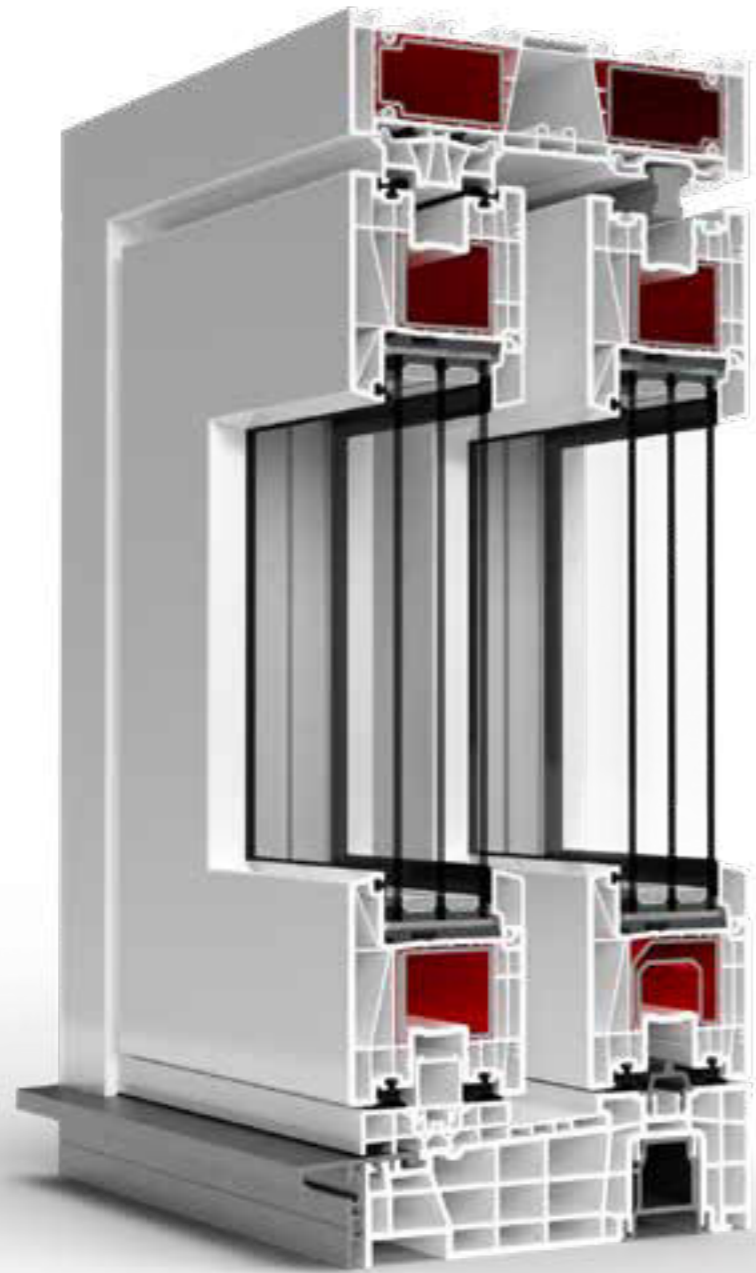

EVOLUTIONDRIVE SF

EVOLUTIONDRIVE 82

EVOLUTIONDRIVE SF

EVOLUTIONDRIVE 82

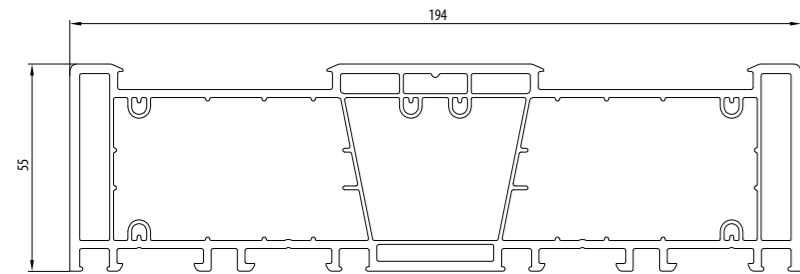

H8050

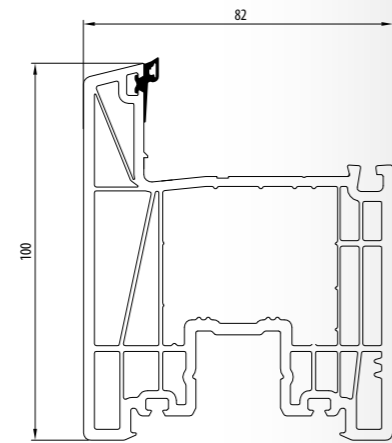

H8600

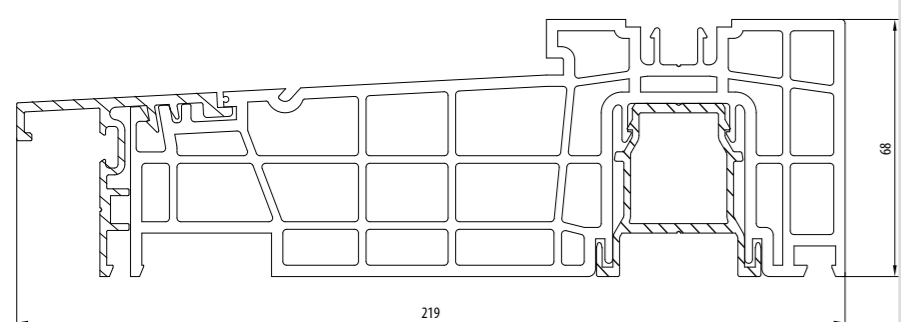

Thermostep

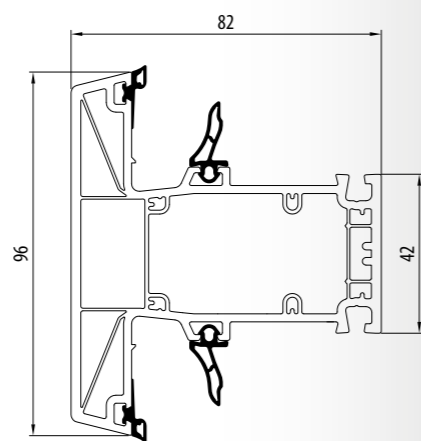

HO9310

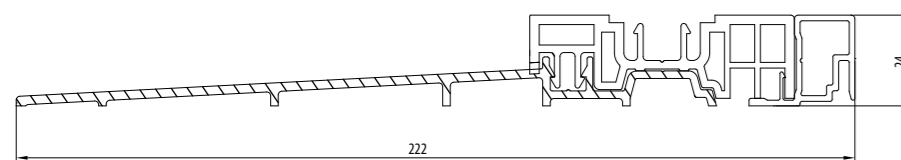

Flatstep

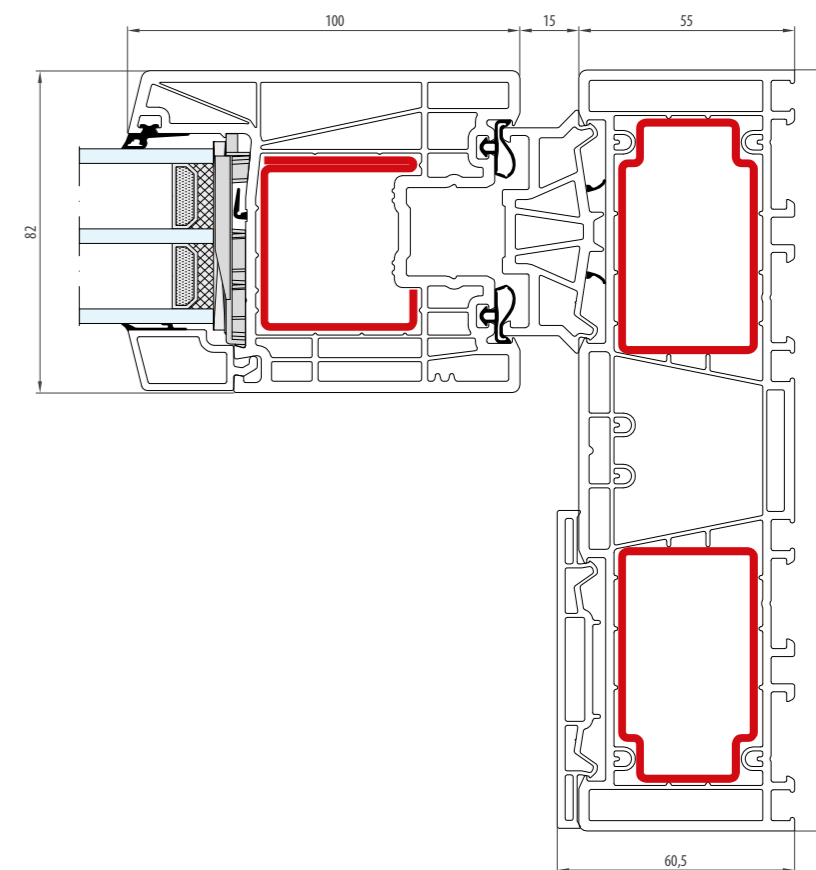
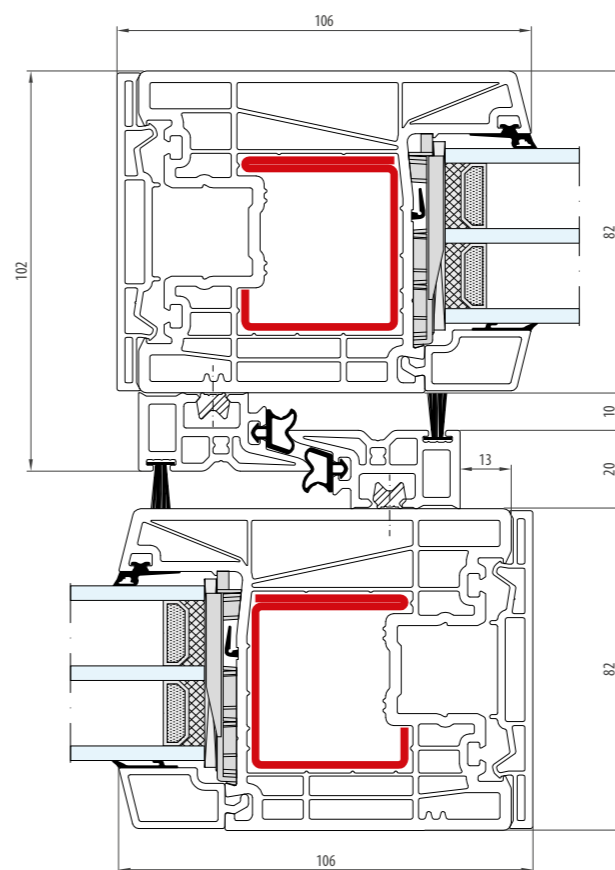
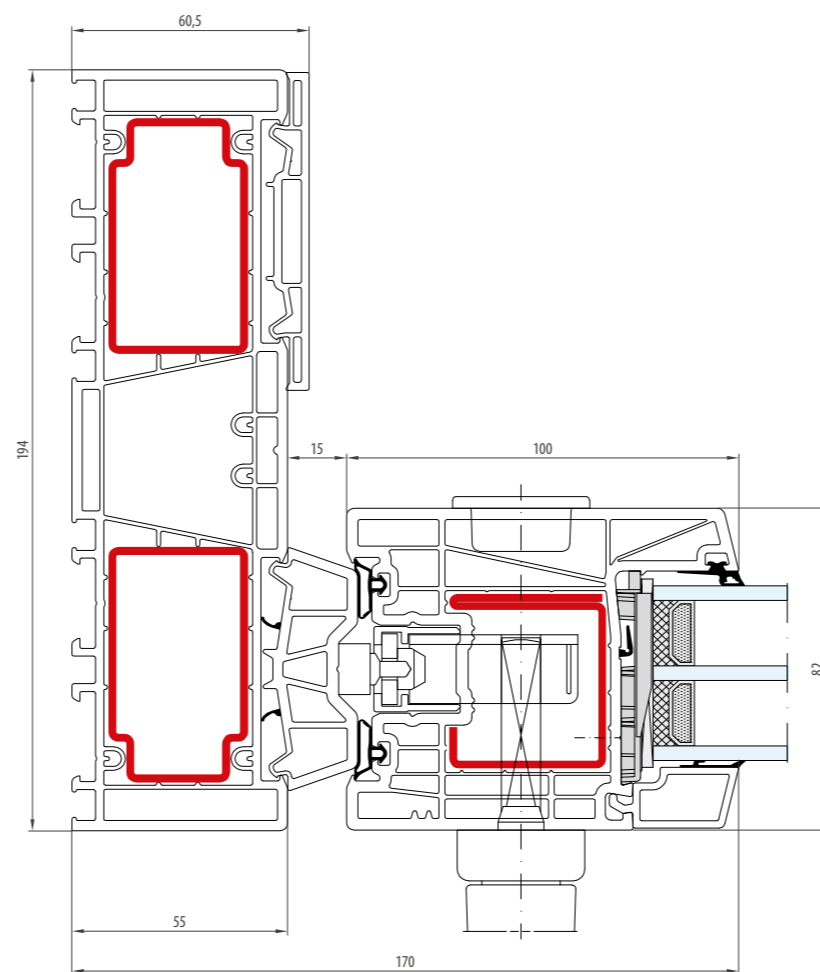

- Schemat A - Przekrój poziomy - Rama: 55 mm · Skrzydło: 100 mm
- Schéma A - Coupe horizontale - Dormant: 55 mm · Vantail: 100 mm
- Schema A - Doorsnede horizontaal - Frame: 55 mm · Sash: 100 mm
- Schema A - Wagerechter Schnitt - Rahmen: 55 mm · Flügel: 100 mm
- Schema A - Sezione orizzontale - Telaio: 55 mm · Anta: 100 mm

1:2

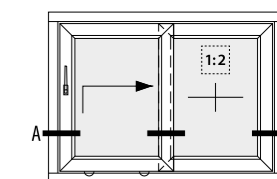

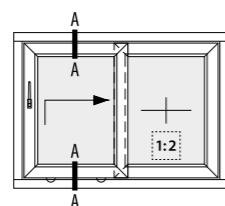
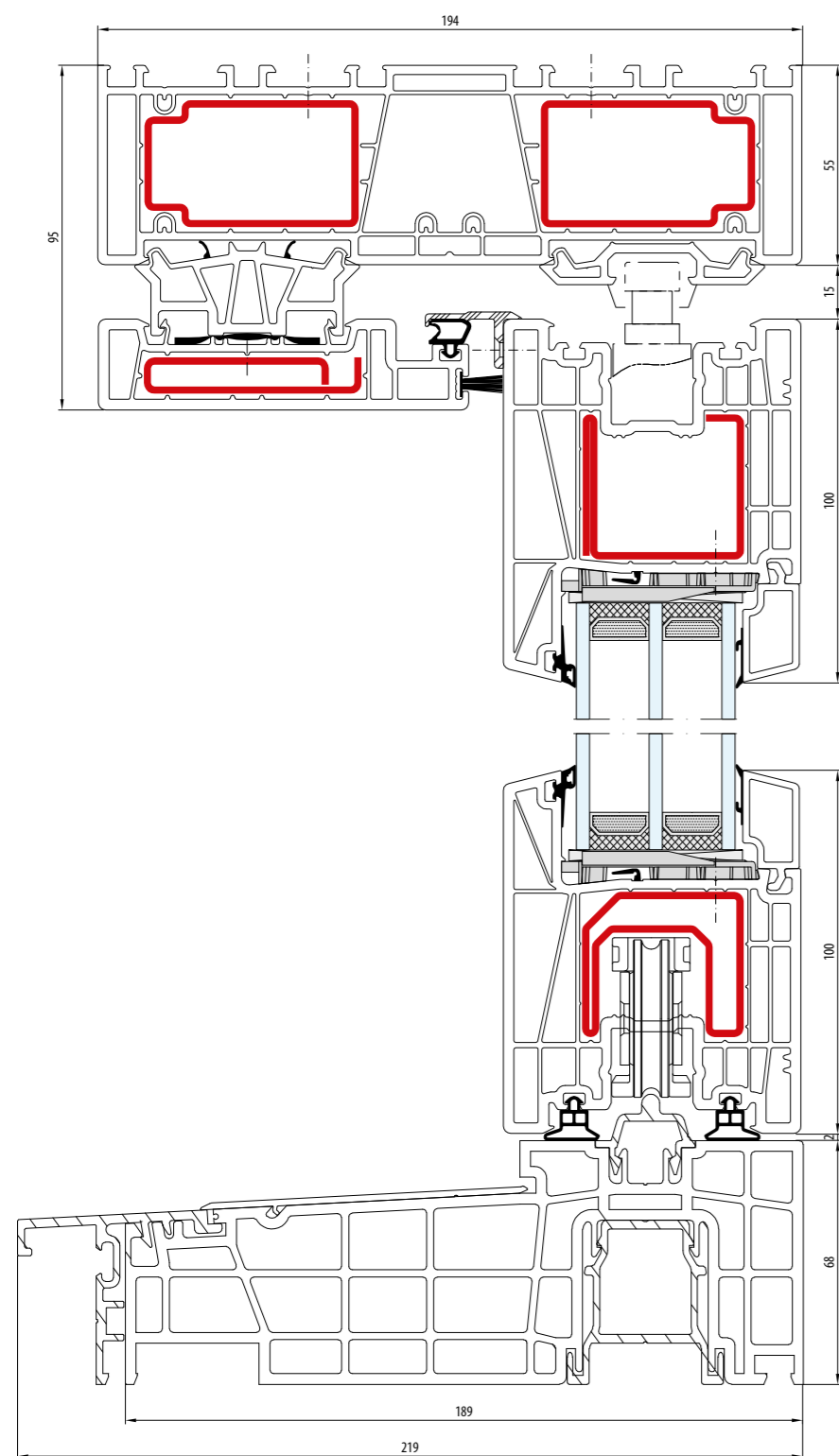

- Schemat A - Przekrój pionowy · Próg: 68 mm · Skrzydło: 100 mm
- Schéma A - Coupe verticale · Seuil: 68 mm · Vantail: 100 mm
- Schema A - Doorsnede verticaal · Doorstep: 68 mm · Sash: 100 mm
- Schema A - Senkrechter Schnitt · Schwelle: 68 mm · Flügel: 100 mm
- Schema A - Sezione verticale · Soglia: 68 mm · Anta: 100 mm

EVOLUTIONDRIVE SF

EVOLUTIONDRIVE 82

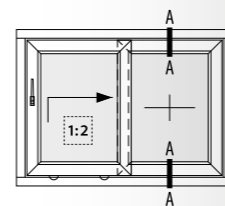
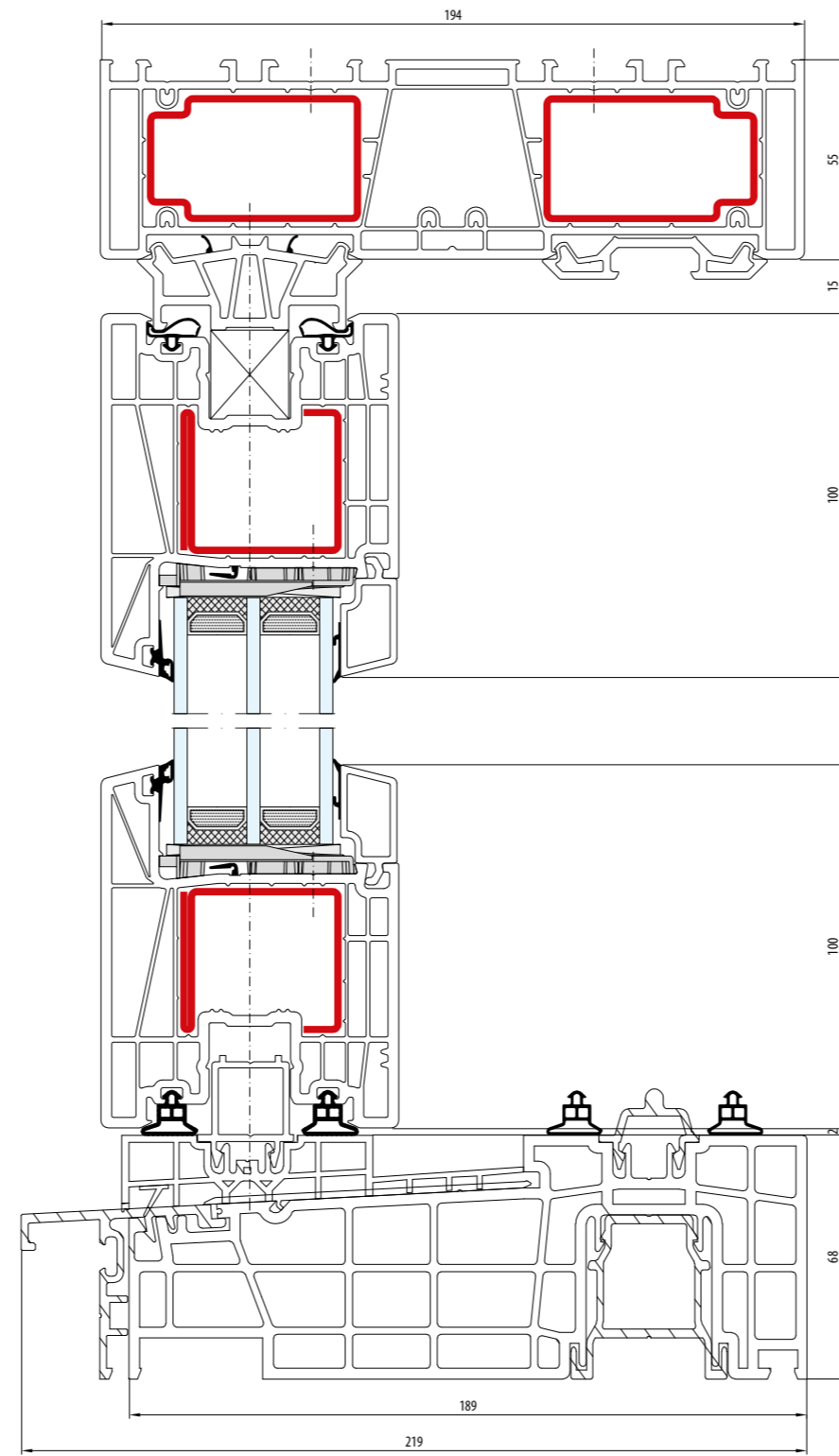

- Schemat A - Przekrój pionowy · Próg: 68 mm · Skrzydło: 100 mm
- Schéma A - Coupe verticale · Seuil: 68 mm · Vantail: 100 mm
- Schema A - Doorsnede verticaal · Doorstep: 68 mm · Sash: 100 mm
- Schema A - Senkrechter Schnitt · Schwelle: 68 mm · Flügel: 100 mm
- Schema A - Sezione verticale · Soglia: 68 mm · Anta: 100 mm

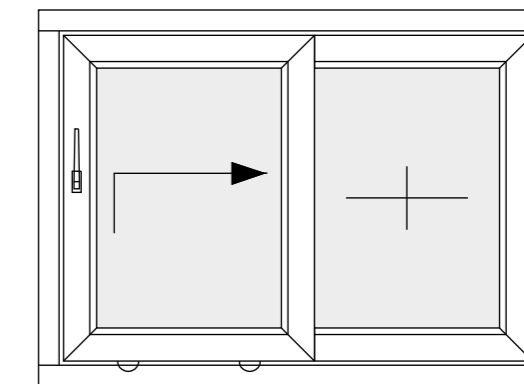

A

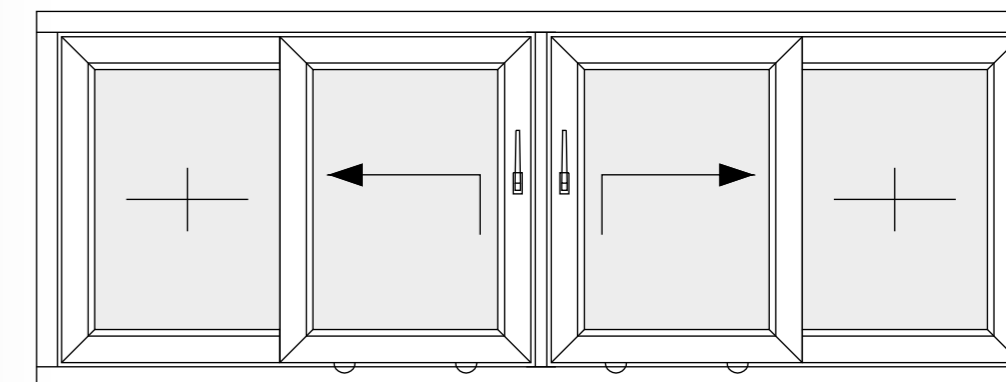

C

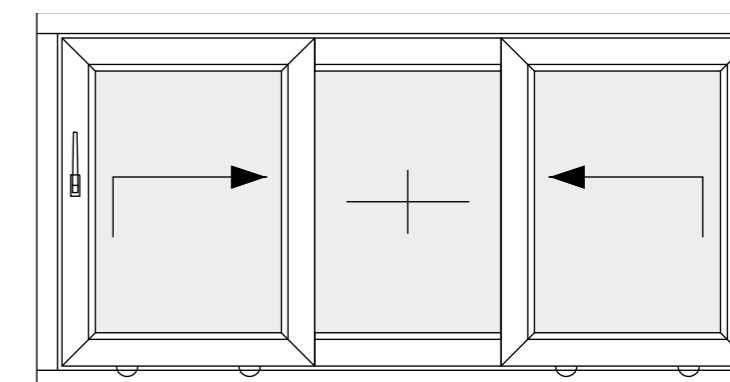









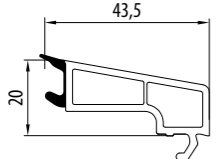
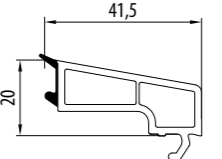
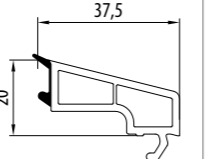
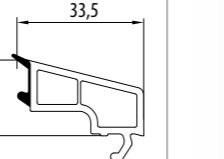
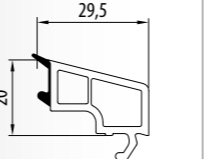
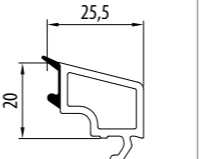
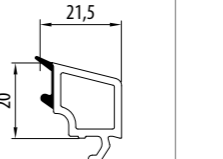
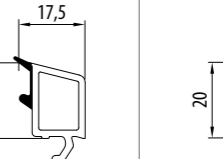
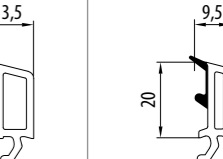
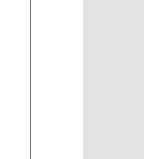

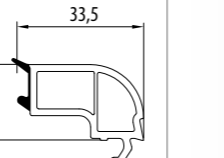
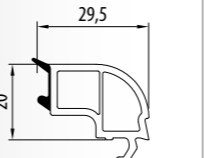
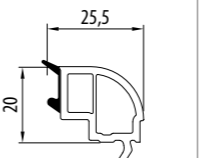
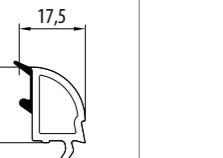
K

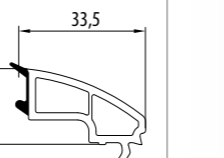
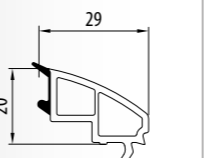
- Schemat
- Schéma
- Schema
- Schema
- Schema

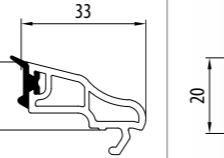
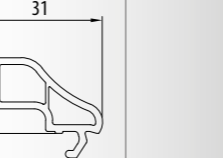
EVOLUTIONDRIVE SF

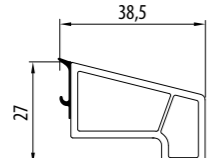
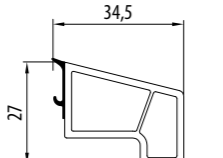
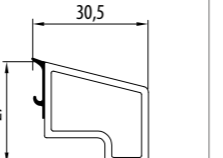
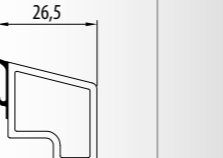
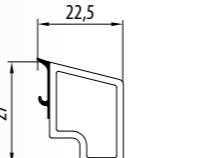
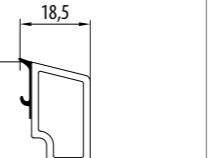
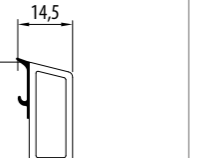
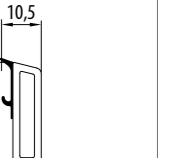
EVOLUTIONDRIVE 82

		d [mm]				d [mm]					
Streamline 76	-	15 - 16 - 17	19 - 20 - 21	23 - 24 - 25	27 - 28 - 29	31 - 32 - 33	35 - 36 - 37	39 - 40 - 41	43 - 44 - 45	47 - 48 - 49	
BluEvolution 92	25 - 26	27 - 28 - 29	31 - 32 - 33	35 - 36 - 37	39 - 40 - 41	43 - 44 - 45	47 - 48 - 49	51 - 52 - 53	55 - 56 - 57	59 - 60 - 61	
	 413 843	 413 841	 413 837	 413 833	 413 829	 413 825	 413 821	 413 817	 413 813	 413 809	
				 413 730	 413 728	 413 725		 413 717			
				 413 735	 413 729						
Streamline 76			23 - 24	25 - 26 - 27							
BluEvolution 92			35 - 36	37 - 38 - 39							
			 413 933	 413 932							
BluEvolution 82 EvolutionDrive 82	23 - 24 - 25	27 - 28 - 29	31 - 32 - 33	35 - 36 - 37	39 - 40 - 41	43 - 44 - 45	47 - 48 - 49	51 - 52 - 53			
	 GP8240	 GP8280	 GP8320	 GP8360	 GP8400	 GP8440	 GP8480	 GP8520			

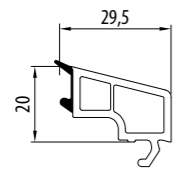
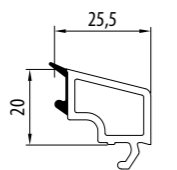
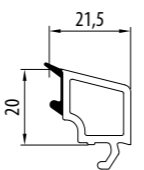
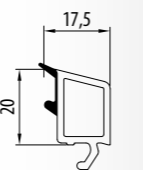
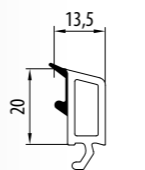
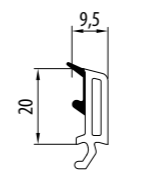
EvolutionDrive SF	d [mm]				d [mm]		
	3 - 4 - 5	7 - 8 - 9	11 - 12 - 13	15 - 16 - 17	19 - 20 - 21	23 - 24 - 25	
	 413 829	 413 825	 413 821	 413 817	 413 813	 413 809	

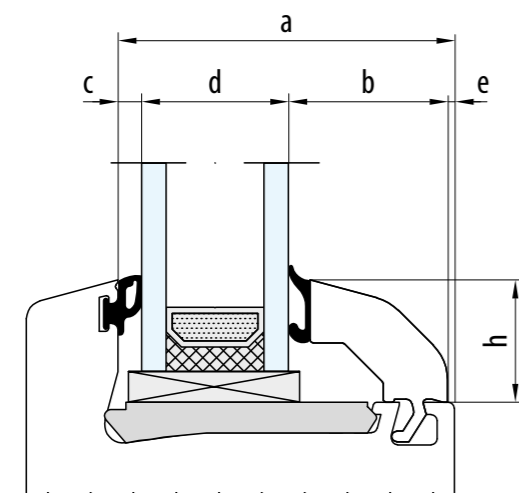

$$b = a - c - d - e$$

	a [mm]	c [mm]	e [mm]
Streamline 76	62	4	1,5
BluEvolution 82	66	4	0,5
BluEvolution 92	74	4	1,5
EvolutionDrive SF	40	4	1,5
EvolutionDrive 82	67	4	0,5

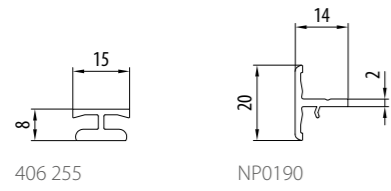

406 255

NP0190

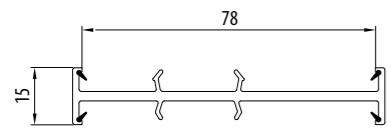

416 260

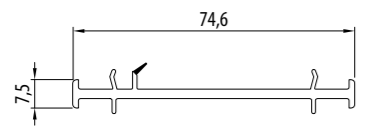

NP8110

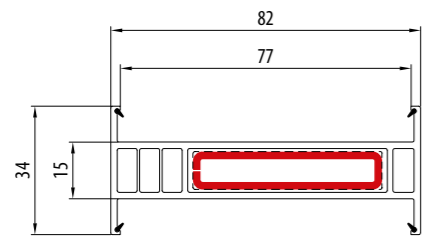

416 273

2,0	405015-074	lx 0,3	ly 5,2
10	405125-000	lx 0,4	ly 10,4

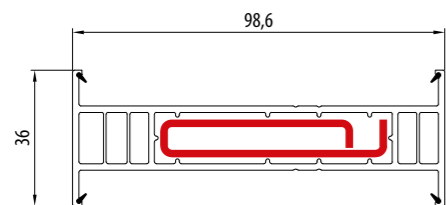

476 273

2,0	415173-074	lx 0,3	ly 8,2
-----	------------	--------	--------

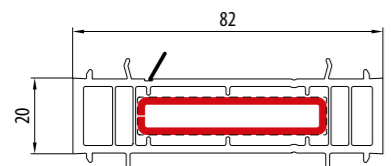

NP8120

2,0	405015-074	lx 0,3	ly 5,2
10	405125-000	lx 0,4	ly 10,4

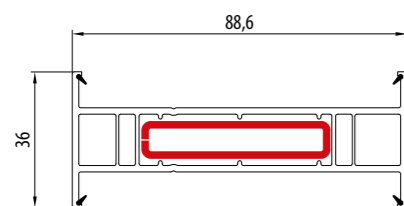

NP8170

2,0	405015-074	lx 0,3	ly 5,2
-----	------------	--------	--------

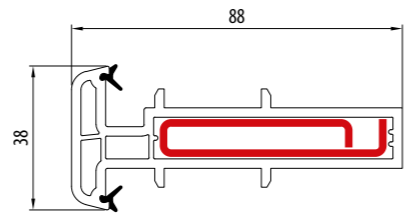

416 272

2,0	415173-074	lx 0,3	ly 8,2
-----	------------	--------	--------

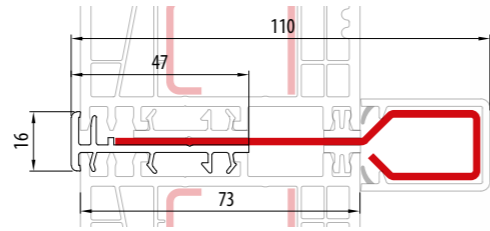

416 264

2,0	VS0140-074	lx 0,8	ly 26,2
-----	------------	--------	---------

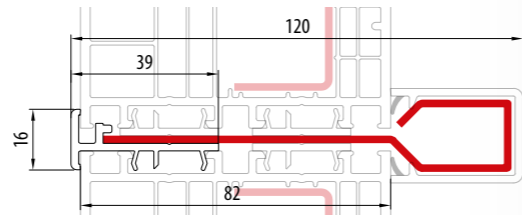

NP8140

2,0	VS8140	lx 0,8	ly 34,0
-----	--------	--------	---------

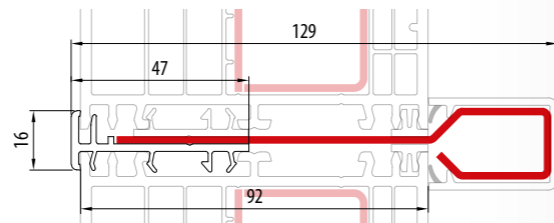

416 264

2,0	415167-074	lx 0,8	ly 40,3
-----	------------	--------	---------

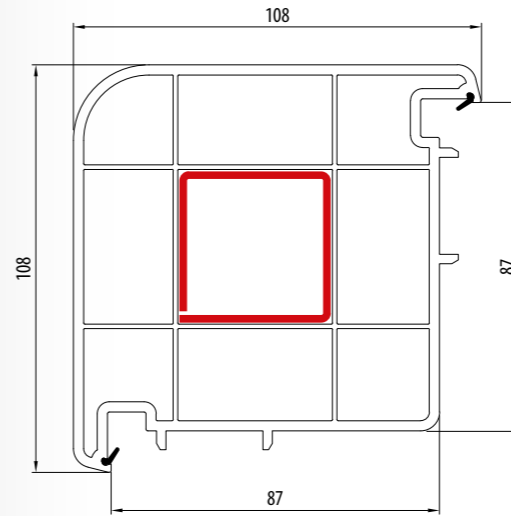

416 210

2,0	405060-074	lx 7,1	ly 7,1
-----	------------	--------	--------

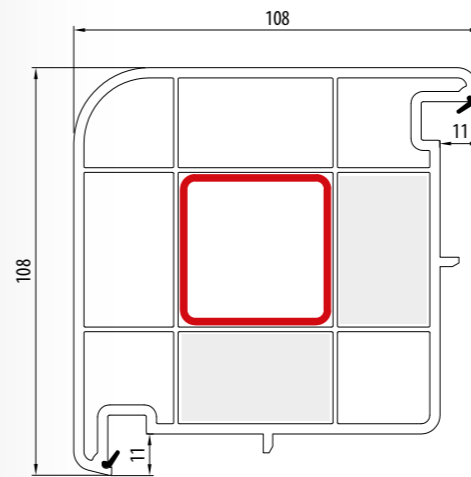

NP0100

2,0	415040-074	lx 7,1	ly 7,1
-----	------------	--------	--------

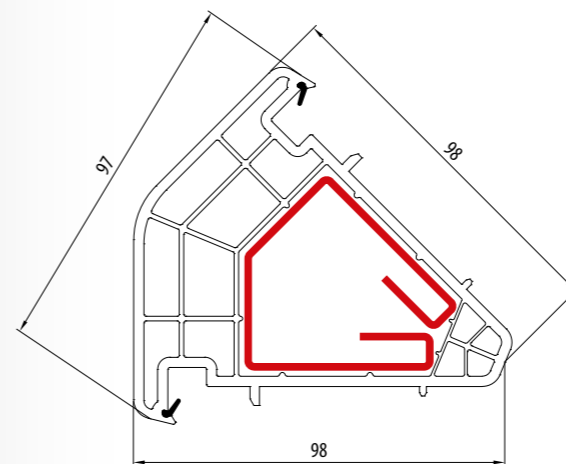

416 240

2,0	415140	lx 10,2	ly 12,9
-----	--------	---------	---------

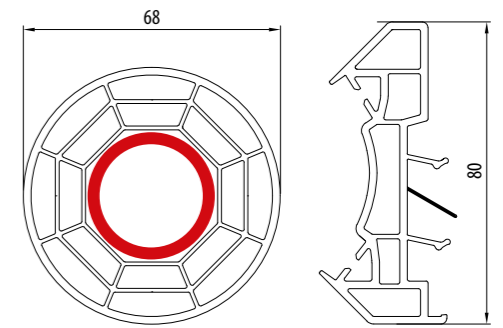

NP0160

3,2	415016	lx 3,6	ly 3,6
-----	--------	--------	--------

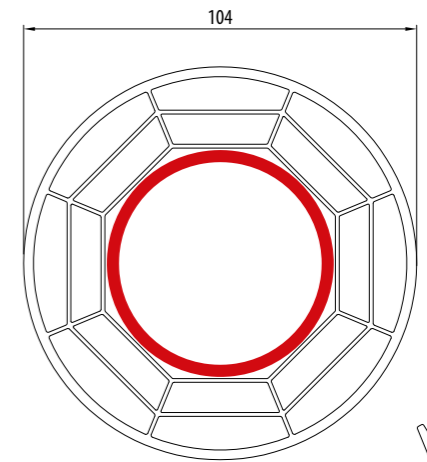

NP8160

3,0	VS8160	lx 21,8	ly 21,8
-----	--------	---------	---------

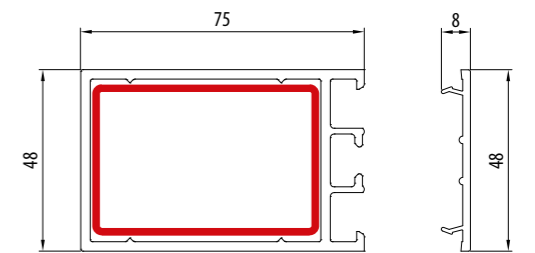

416 269

2,0	AR4630	lx 18,5	ly 9,8
-----	--------	---------	--------

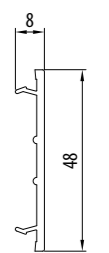

416 311

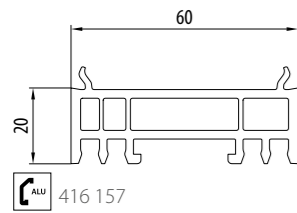

416 157

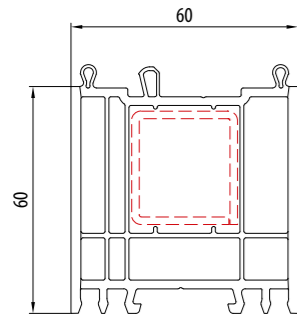

416 168

-	0,0	-	lx 0,0	ly 0,0
□	1,5	415028-073	lx 1,9	ly 2,1

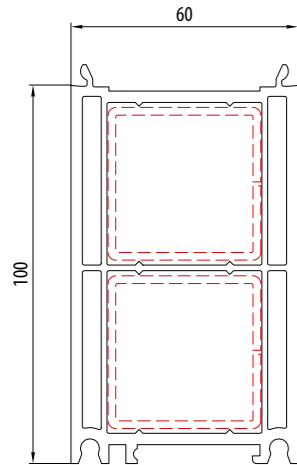

406 176

-	0,0	-	lx 0,0	ly 0,0
□	2,0	405060-074 x 2	lx 14,4	ly 14,2

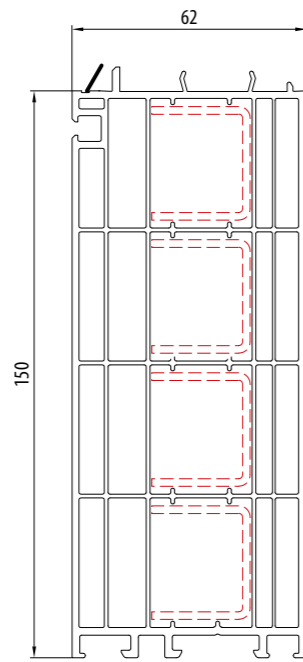

NP8280

-	0,0	-	lx 0,0	ly 0,0
□	2,0	VS8020-074 x 4	lx 9,0	ly 4,2

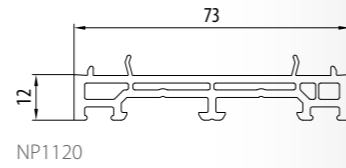

NP1120

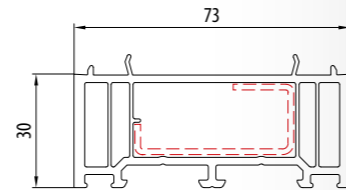

NP1350

-	0,0	-	lx 0,0	ly 0,0
□	1,5	VS1010-073	lx 0,5	ly 2,3

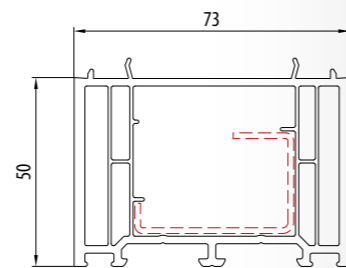

NP1550

-	0,0	-	lx 0,0	ly 0,0
□	1,5	VS1020-073	lx 1,3	ly 2,6

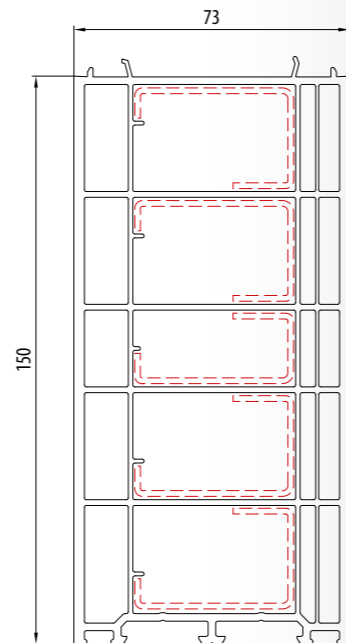

NP3300

-	0,0	-	lx 0,0	ly 0,0
□	1,5	VS1020-073 x 4	lx 5,8	ly 12,7
	1,5	+VS1010-073		

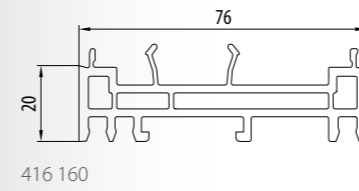

416 160

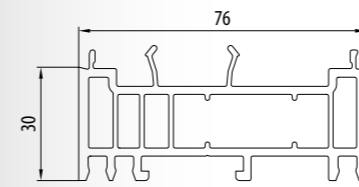

416 163

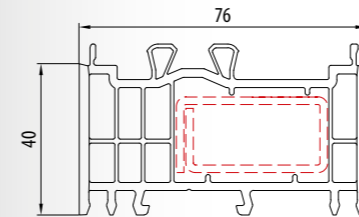

416 167

-	0,0	-	lx 0,0	ly 0,0
□	2,0	415020	lx 1,4	ly 4,9

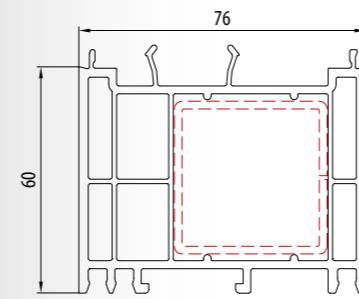

416 170

-	0,0	-	lx 0,0	ly 0,0
□	2,0	405060-074	lx 7,2	ly 7,1

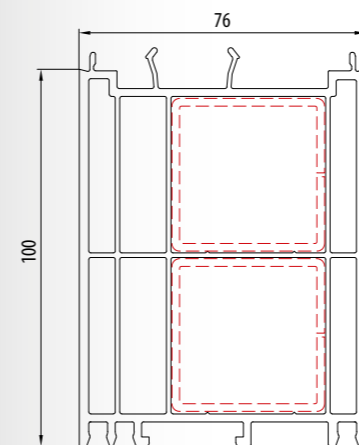

416 176

-	0,0	-	lx 0,0	ly 0,0
□	2,0	405060-074 x 2	lx 14,4	ly 14,2

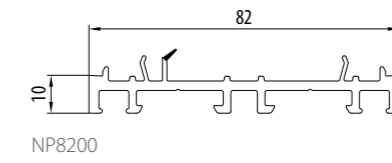

NP8200

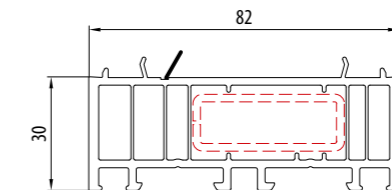

NP8300

-	0,0	-	lx 0,0	ly 0,0
□	2,0	VS4020-074	lx 0,7	ly 3,4

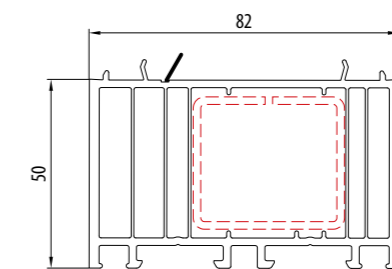

NP8500

-	0,0	-	lx 0,0	ly 0,0
□	1,5	VS3030	lx 3,9	ly 4,9

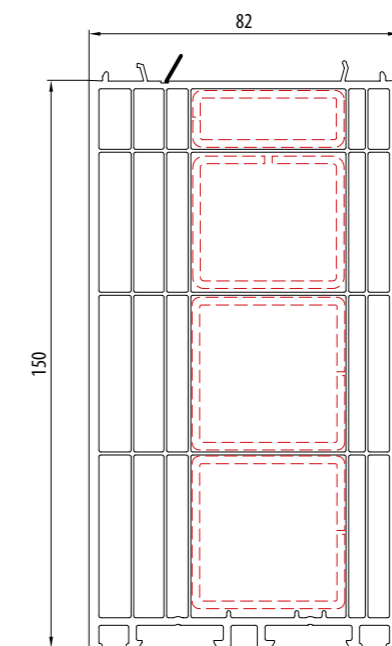

NP8700

-	0,0	-	lx 0,0	ly 0,0
□	1,5	VS4020		
	1,5	+VS3030	lx 20,0	ly 21,5
	2,0	+415040 x 2		

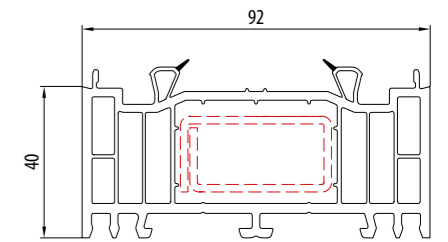

476 164

-	0,0	-	lx 0,0	ly 0,0
□	2,0	415020	lx 1,4	ly 4,9

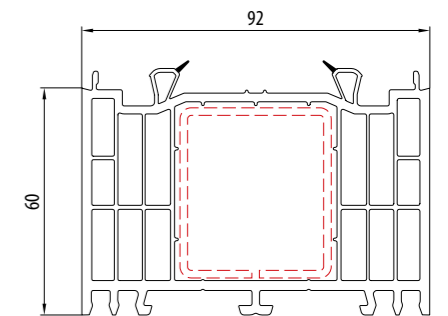

476 170

-	0,0	-	lx 0,0	ly 0,0
□	2,0	215130	lx 7,7	ly 9,1

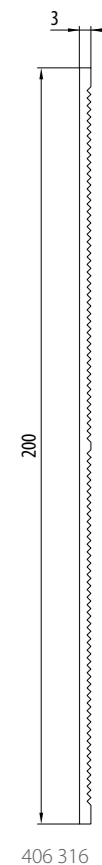
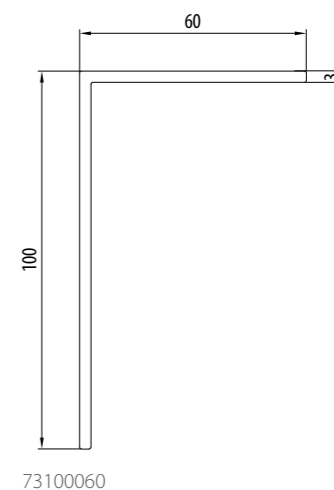
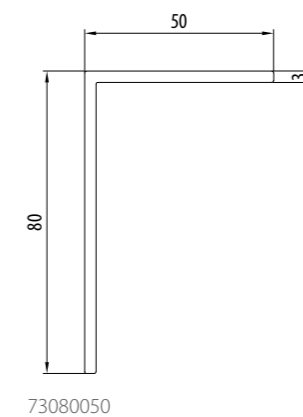
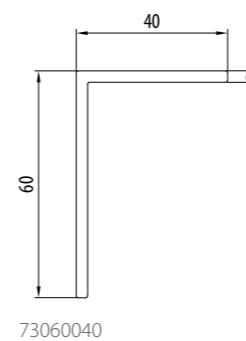
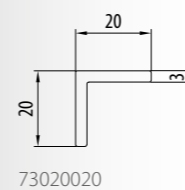
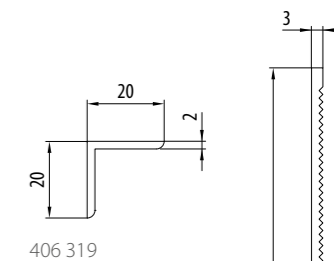
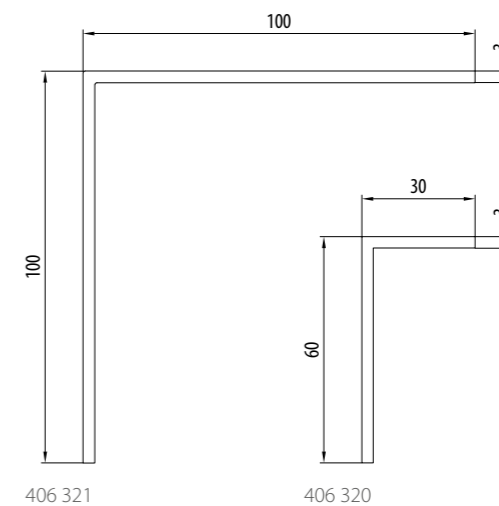
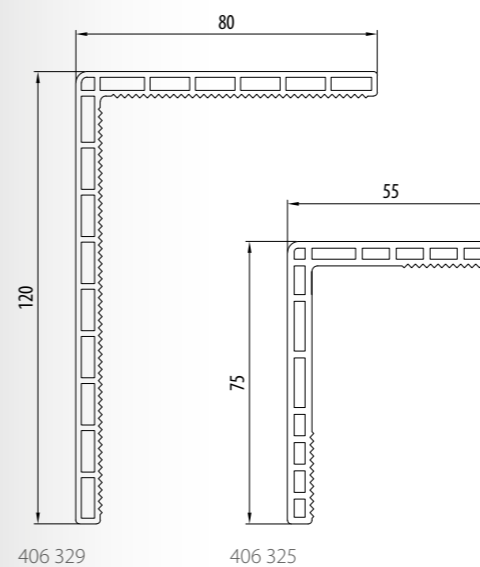
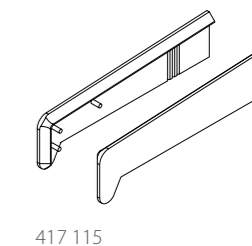
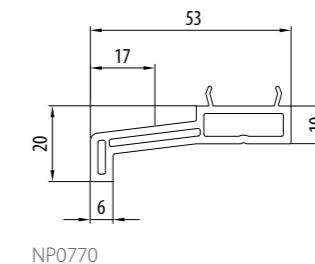
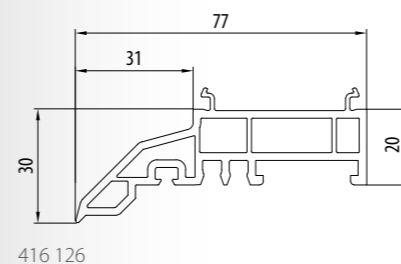
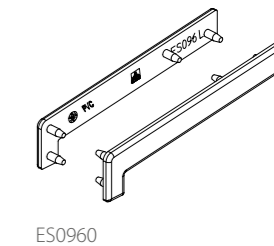
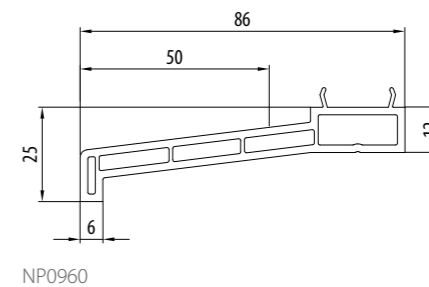
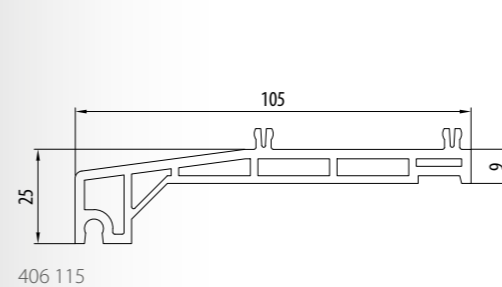
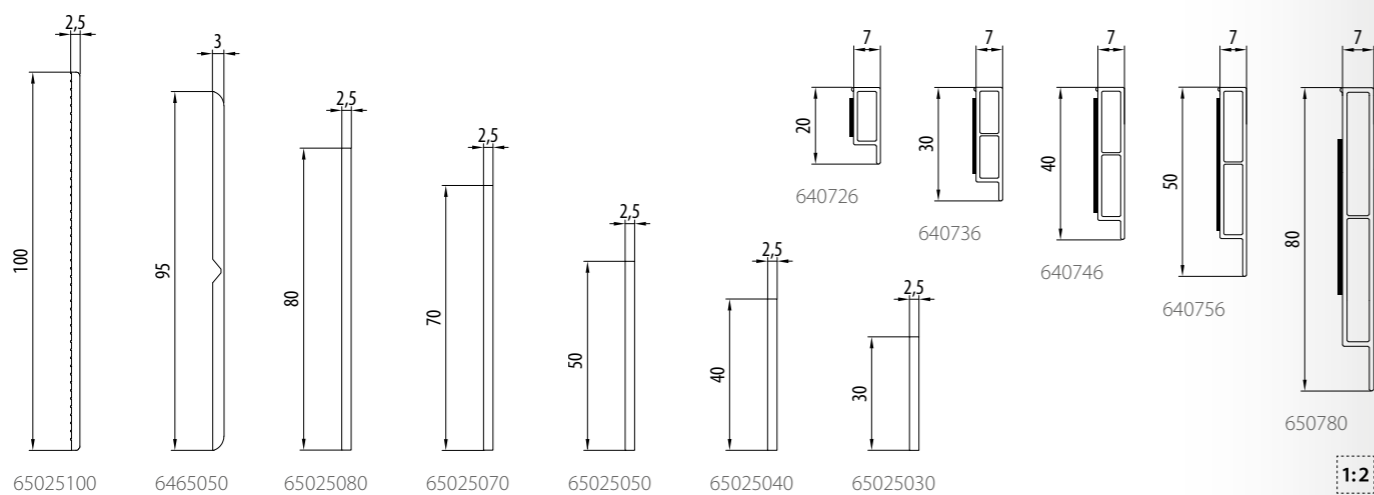
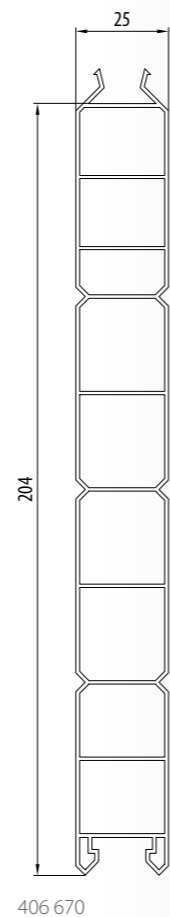
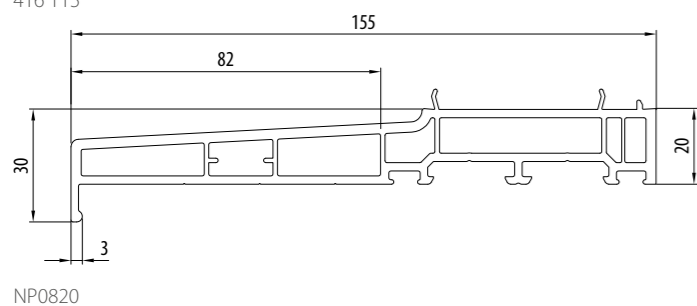
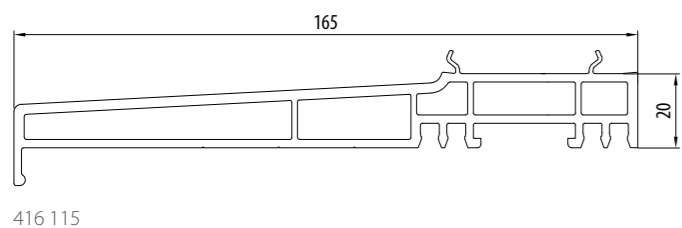
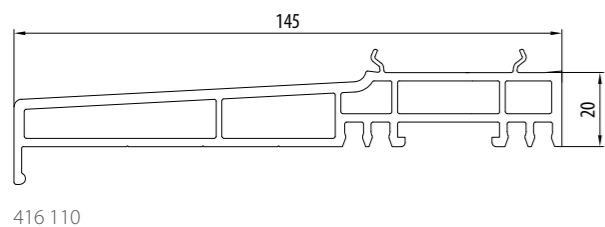
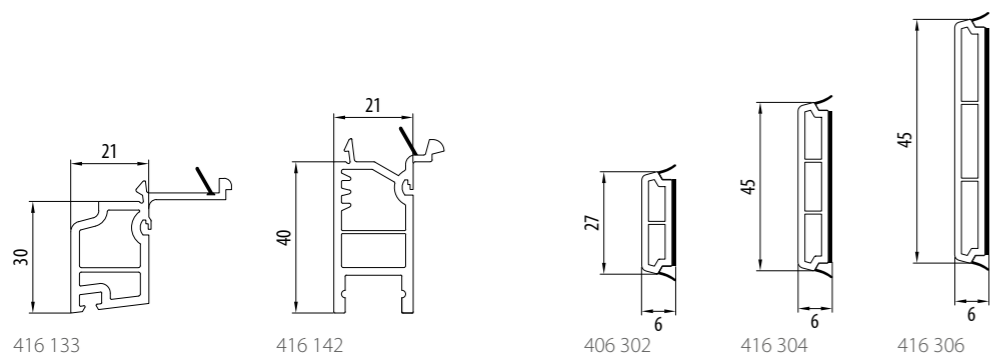
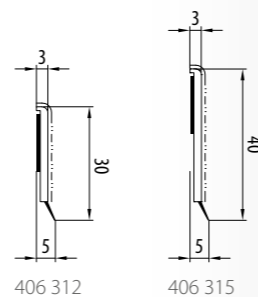
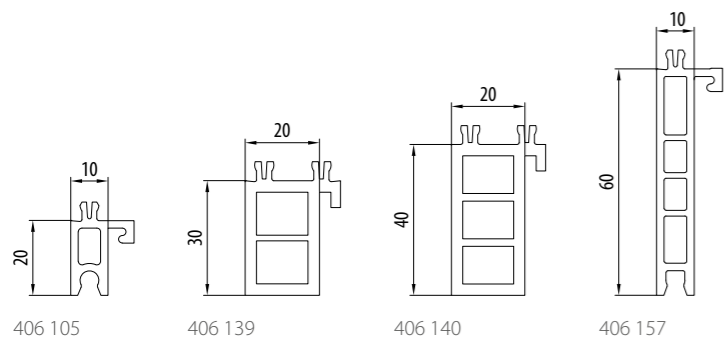



**OKO
SUN**



EKOSUN 70

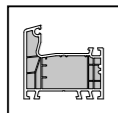

6



2

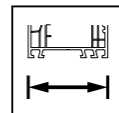

70

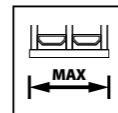

45

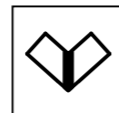

V SUPER SOLUTION

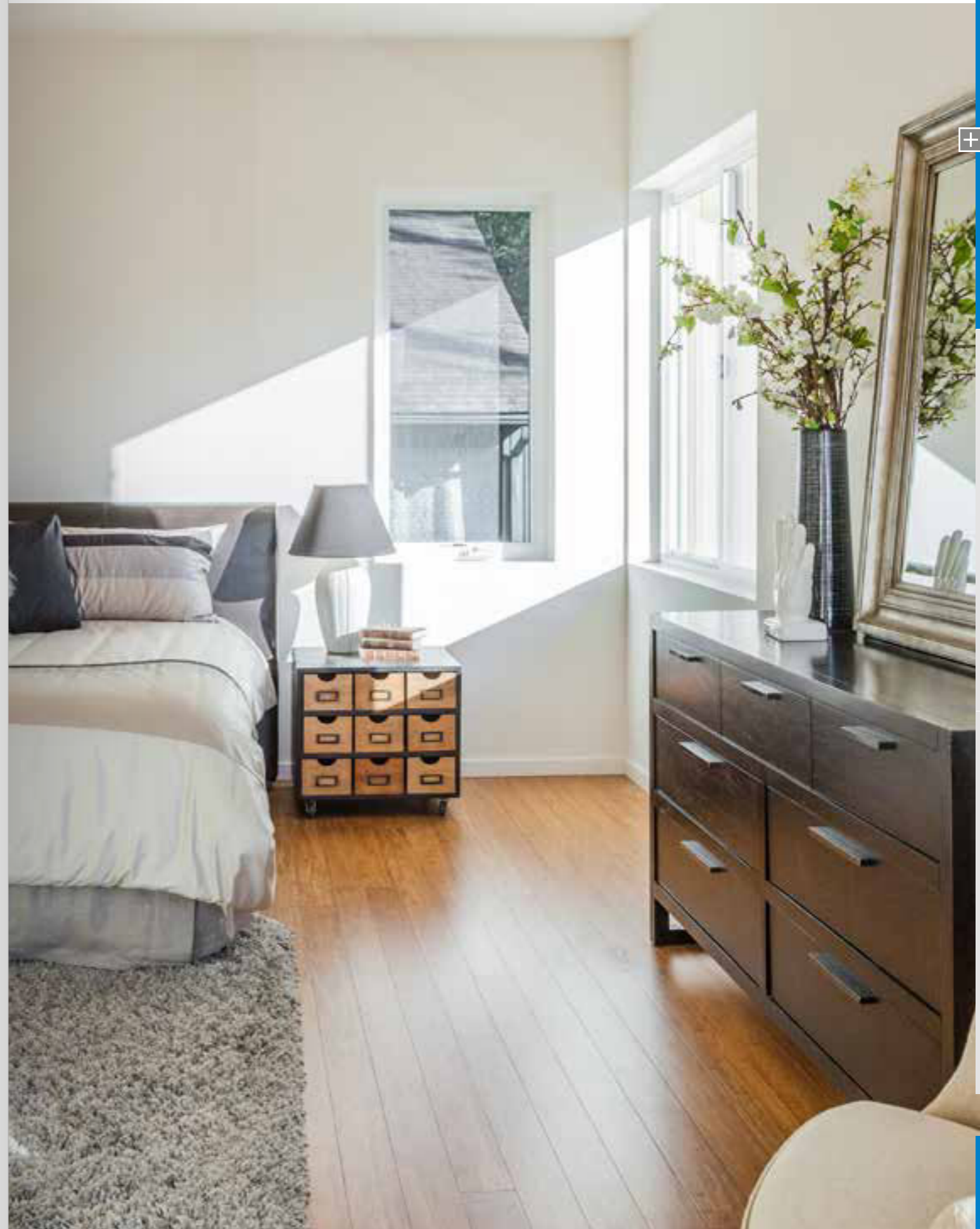

EKOSUN 70

EKOSUN 6

EKOSUN 7

EKOSUN 70

EKOSUN 6

EKOSUN 7

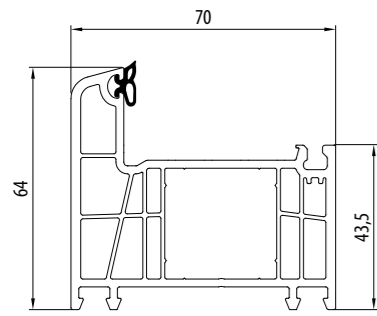

7110

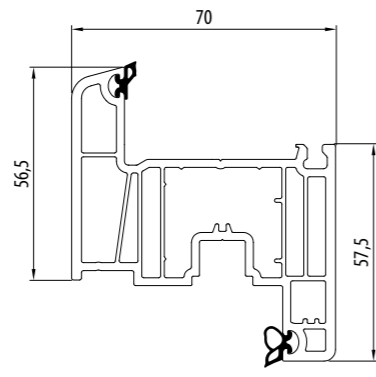

7120

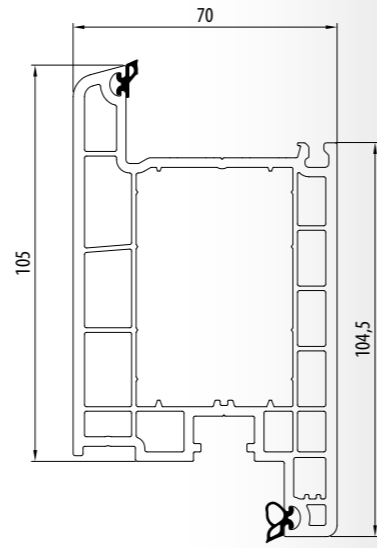

7124

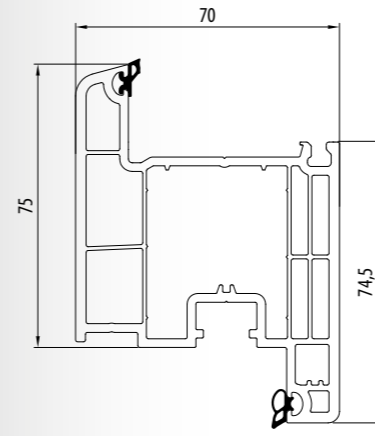

7126

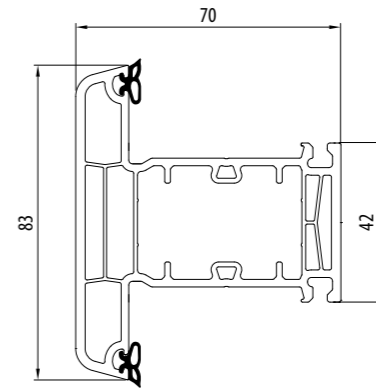

7230

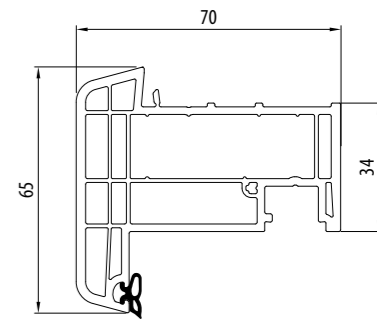

7232

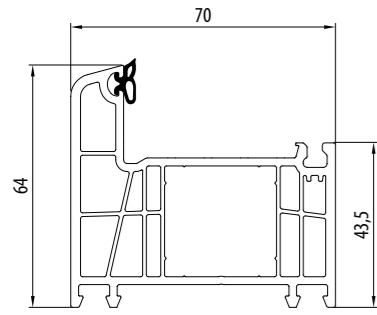

7111

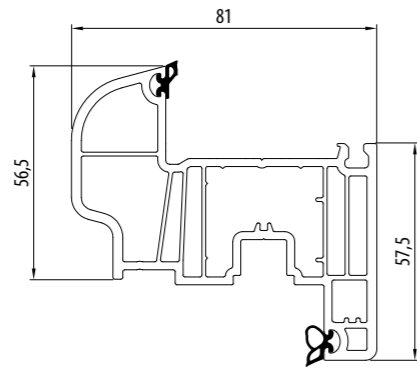

7121

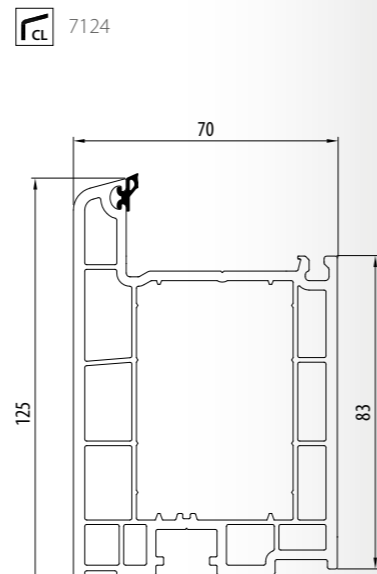

7125

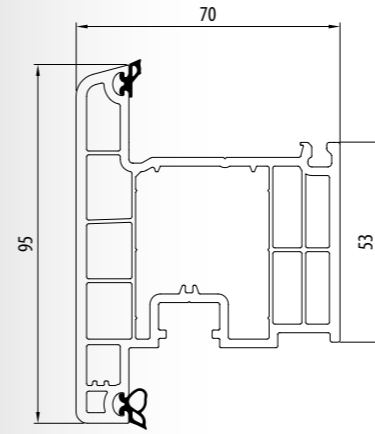

7127

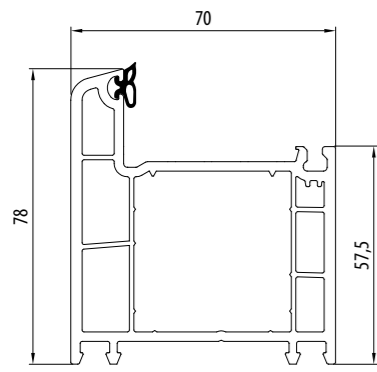

7112

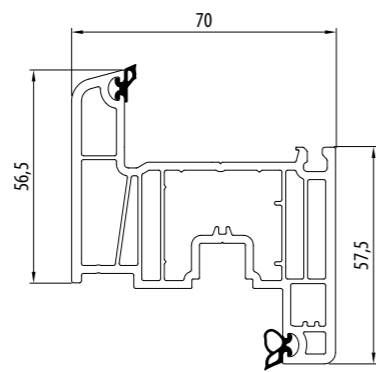

7122

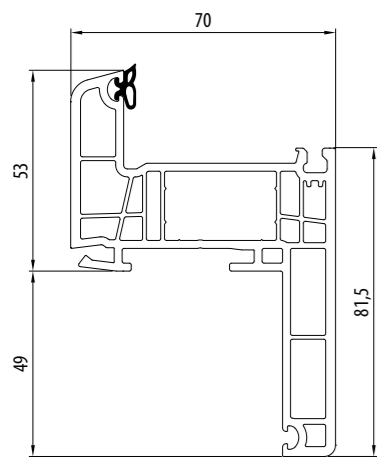

7113

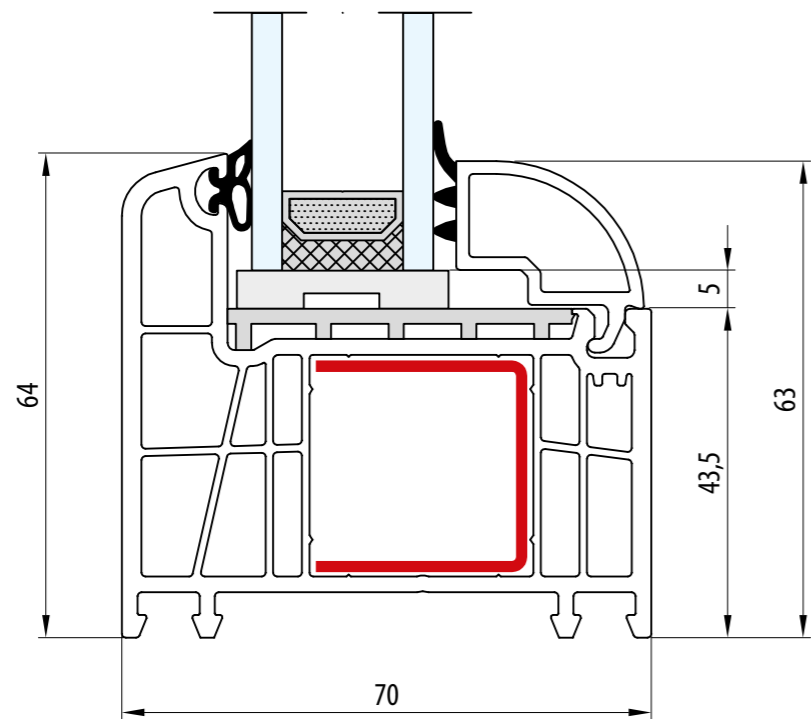

- Rama: 64 mm
- Dormant: 64 mm
- Frame: 64 mm
- Rahmen: 64 mm
- Telaio: 64 mm

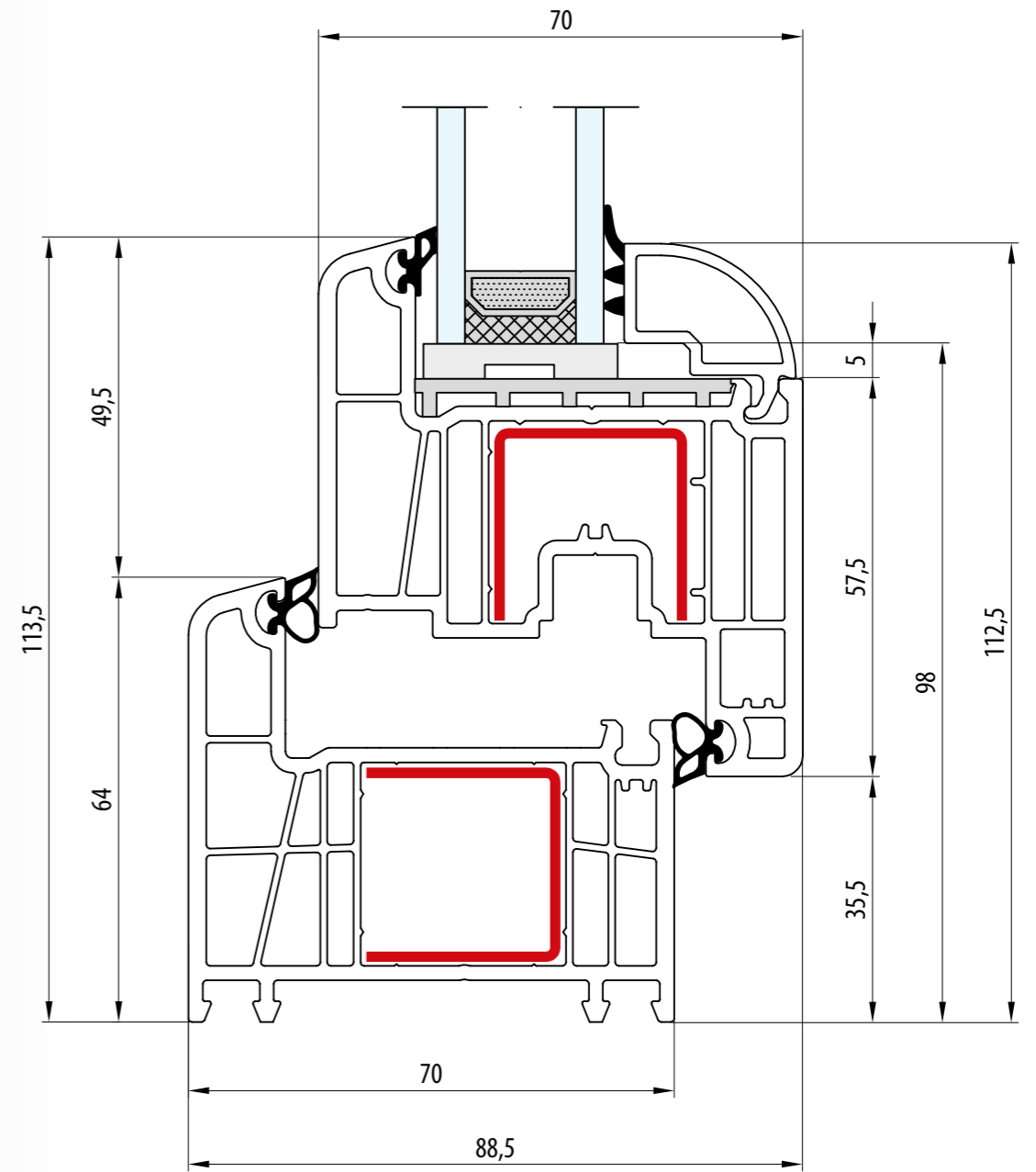
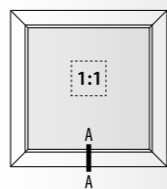

- Rama: 64 mm · Skrzydło: 77 mm
- Dormant: 64 mm · Vantail: 77 mm
- Frame: 64 mm · Sash: 77 mm
- Rahmen: 64 mm · Flügel: 77 mm
- Telaio: 64 mm · Anta: 77 mm

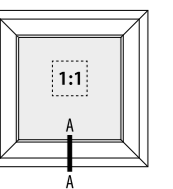

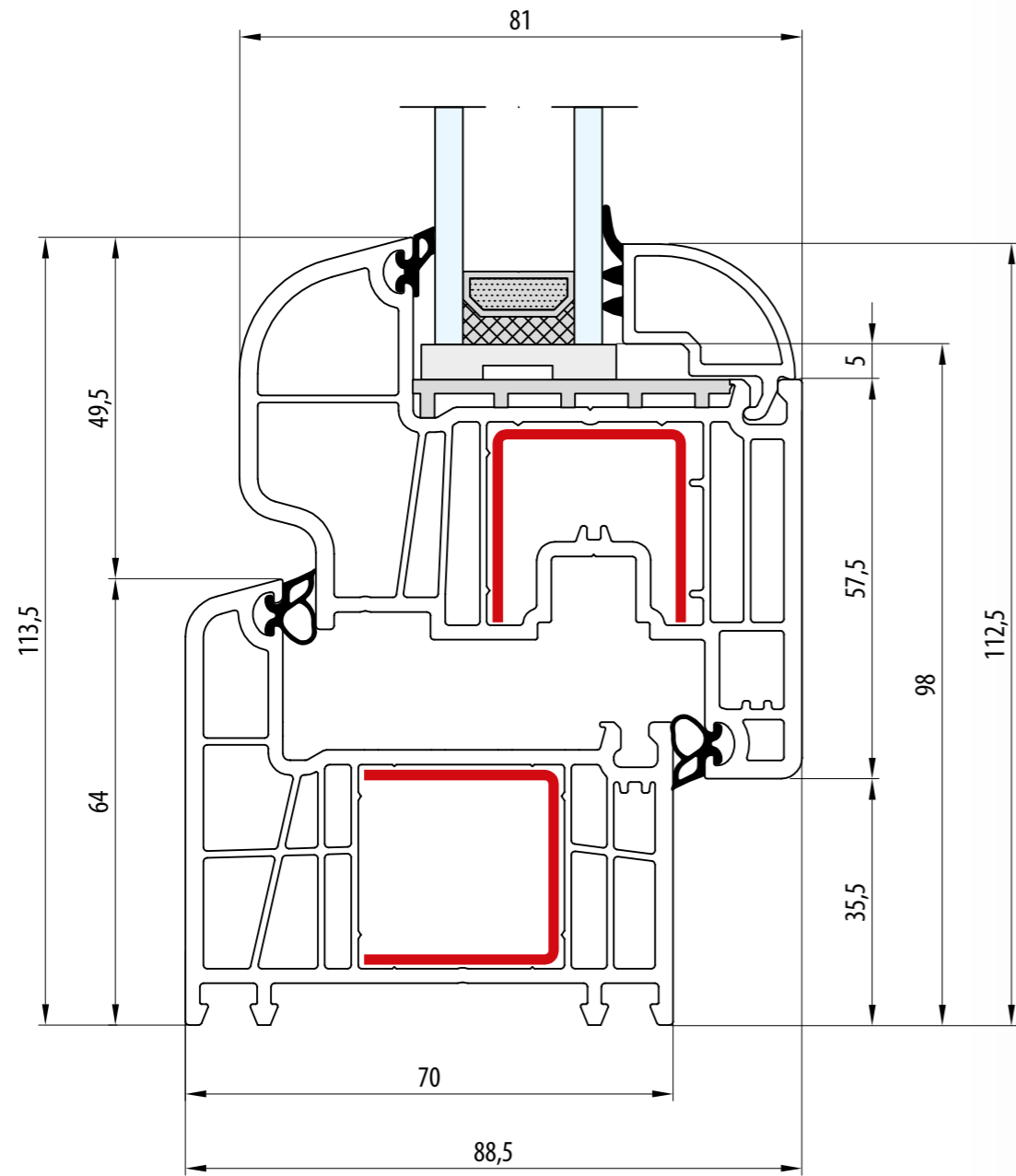

- Rama: 64 mm · Skrzydło: 77 mm
- Dormant: 64 mm · Vantail: 77 mm
- Frame: 64 mm · Sash: 77 mm
- Rahmen: 64 mm · Flügel: 77 mm
- Telaio: 64 mm · Anta: 77 mm

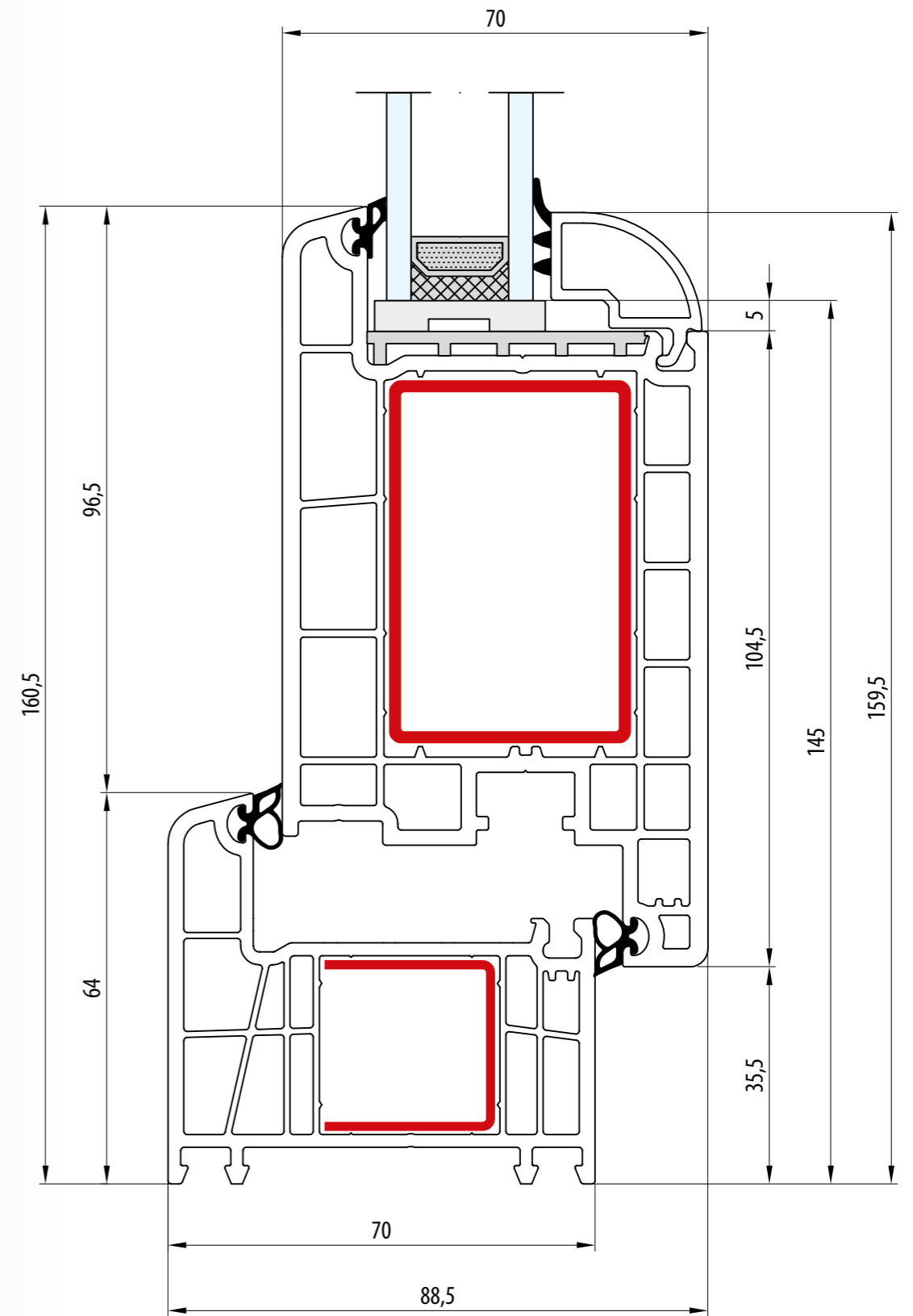
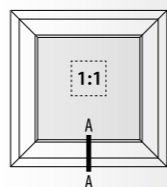

- Rama: 64 mm · Skrzydło: 125 mm
- Dormant: 64 mm · Vantail: 125 mm
- Frame: 64 mm · Sash: 125 mm
- Rahmen: 64 mm · Flügel: 125 mm
- Telaio: 64 mm · Anta: 125 mm

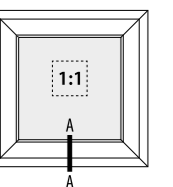

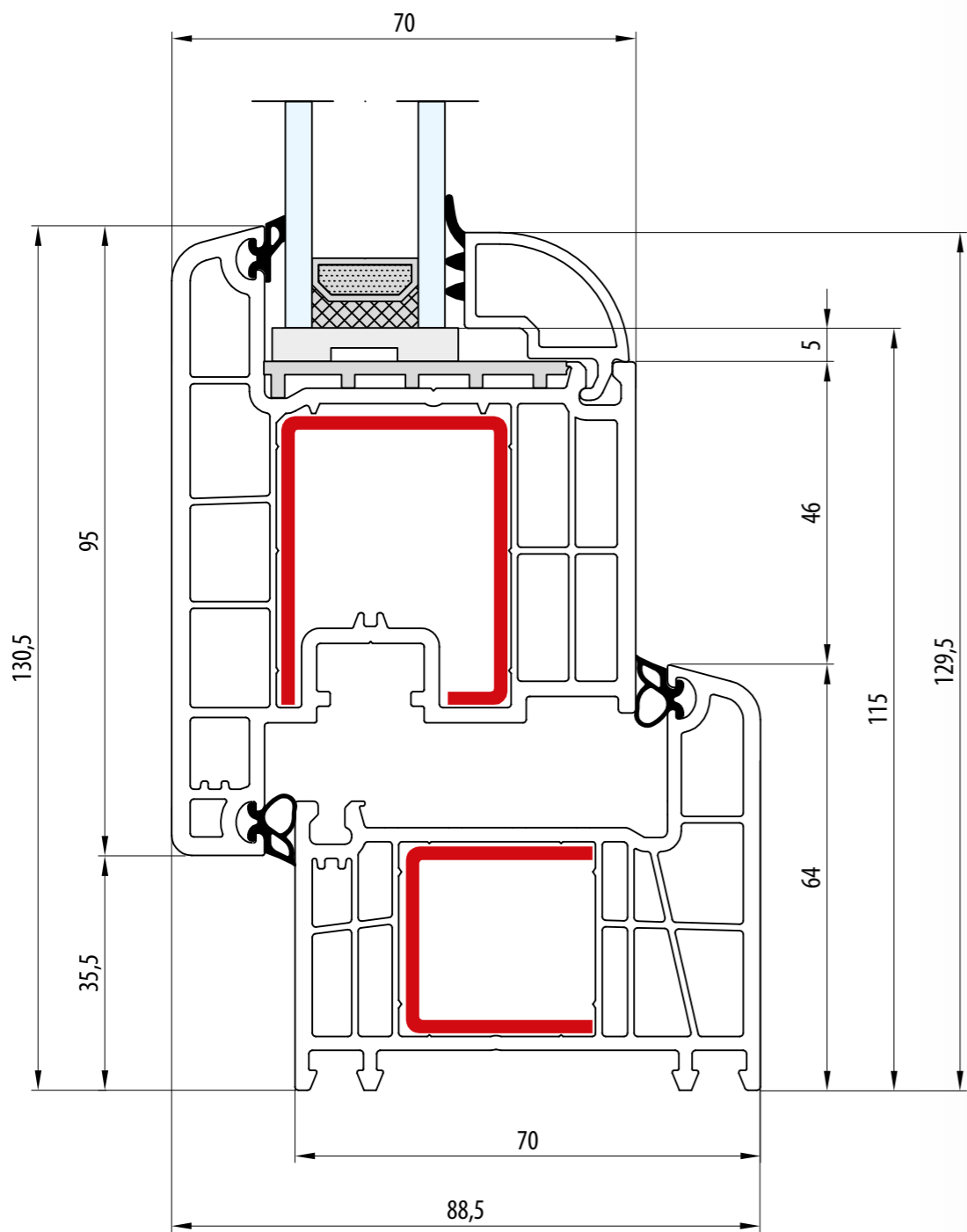

- Rama: 64 mm · Skrzydło: 95 mm
- Dormant: 64 mm · Vantail: 95 mm
- Frame: 64 mm · Sash: 95 mm
- Rahmen: 64 mm · Flügel: 95 mm
- Telaio: 64 mm · Anta: 95 mm

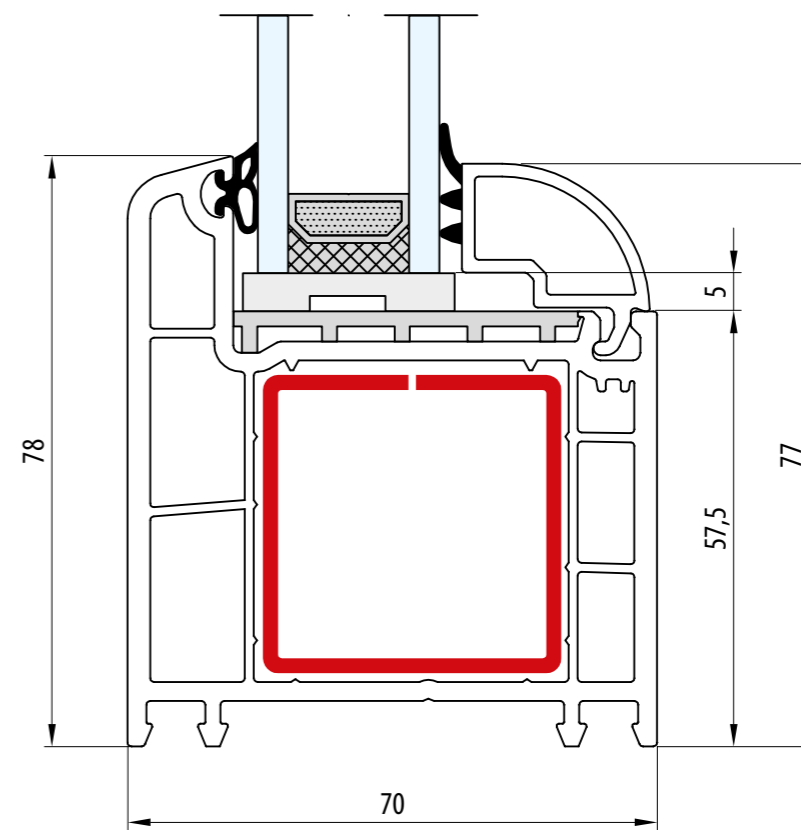
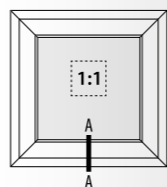

- Rama: 78 mm
- Dormant: 78 mm
- Frame: 78 mm
- Rahmen: 78 mm
- Telaio: 78 mm

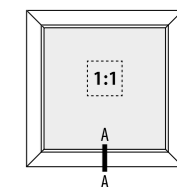

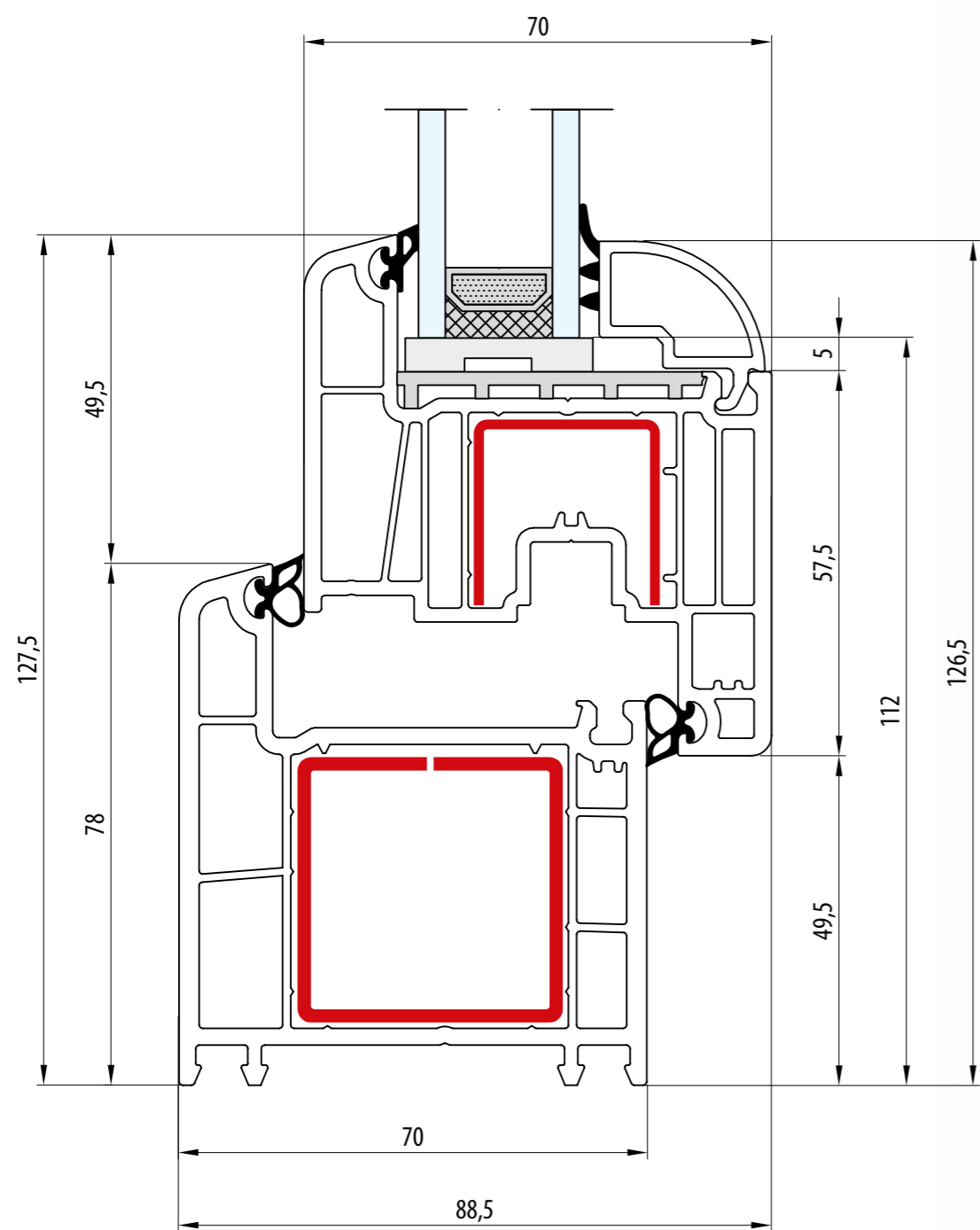

- Rama: 78 mm · Skrzydło: 77 mm
- Dormant: 78 mm · Vantail: 77 mm
- Frame: 78 mm · Sash: 77 mm
- Rahmen: 78 mm · Flügel: 77 mm
- Telaio: 78 mm · Anta: 77 mm

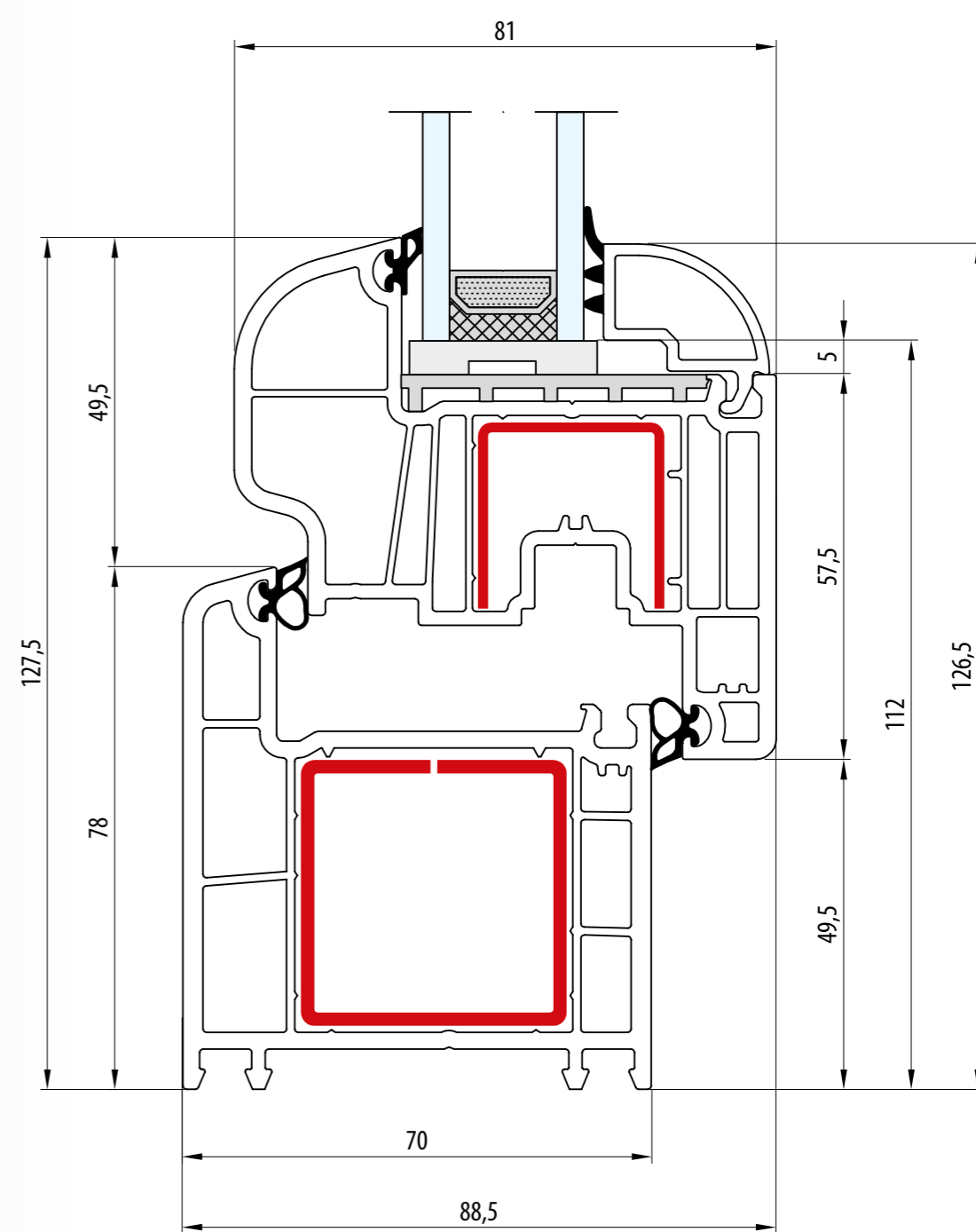
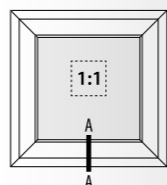

- Rama: 78 mm · Skrzydło: 77 mm
- Dormant: 78 mm · Vantail: 77 mm
- Frame: 78 mm · Sash: 77 mm
- Rahmen: 78 mm · Flügel: 77 mm
- Telaio: 78 mm · Anta: 77 mm

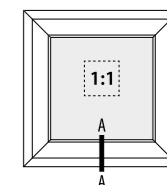

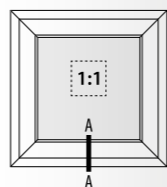
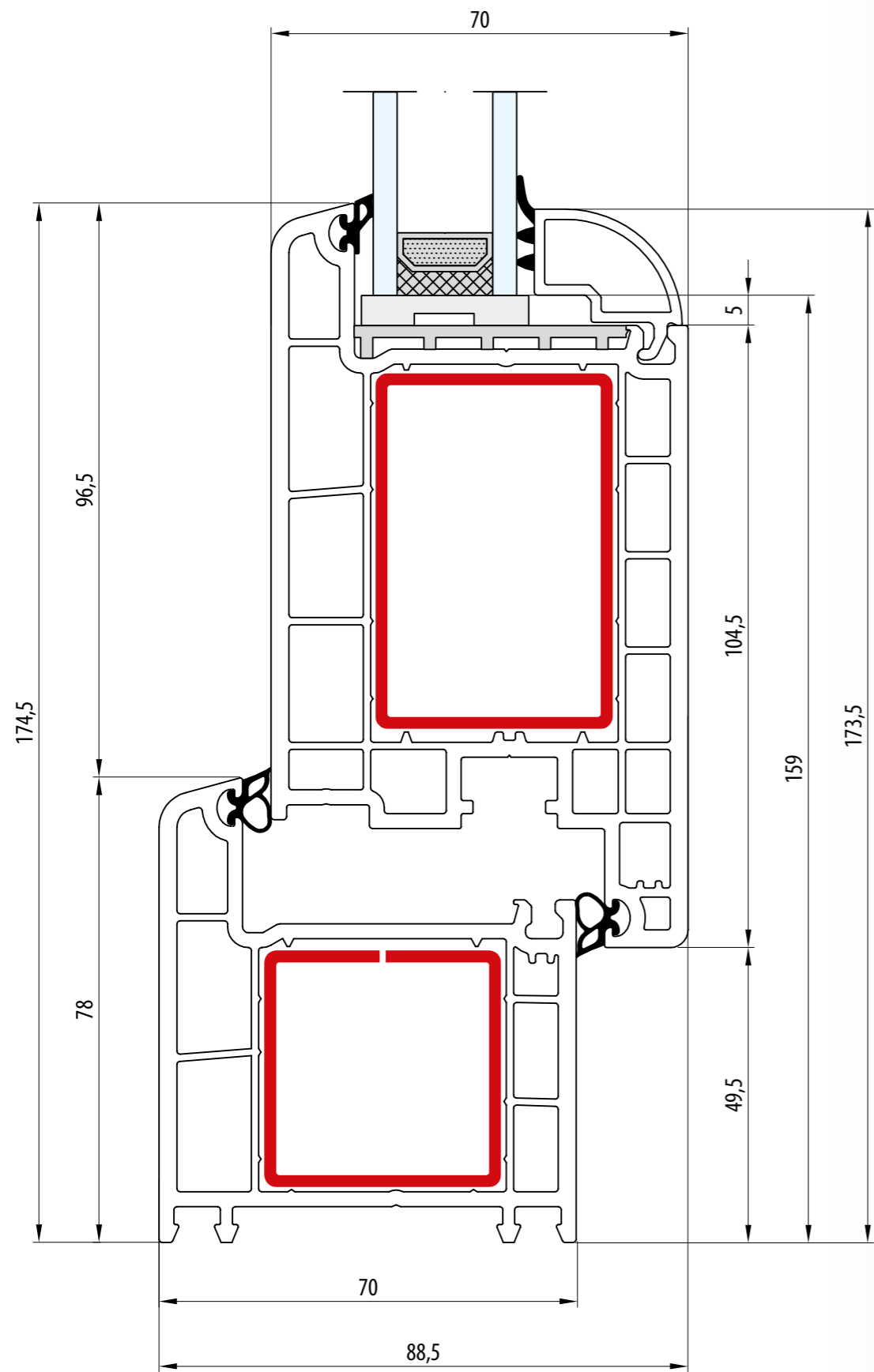

- Rama: 78 mm · Skrzydło: 125 mm
- Dormant: 78 mm · Vantail: 125 mm
- Frame: 78 mm · Sash: 125 mm
- Rahmen: 78 mm · Flügel: 125 mm
- Telaio: 78 mm · Anta: 125 mm

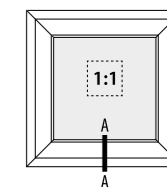
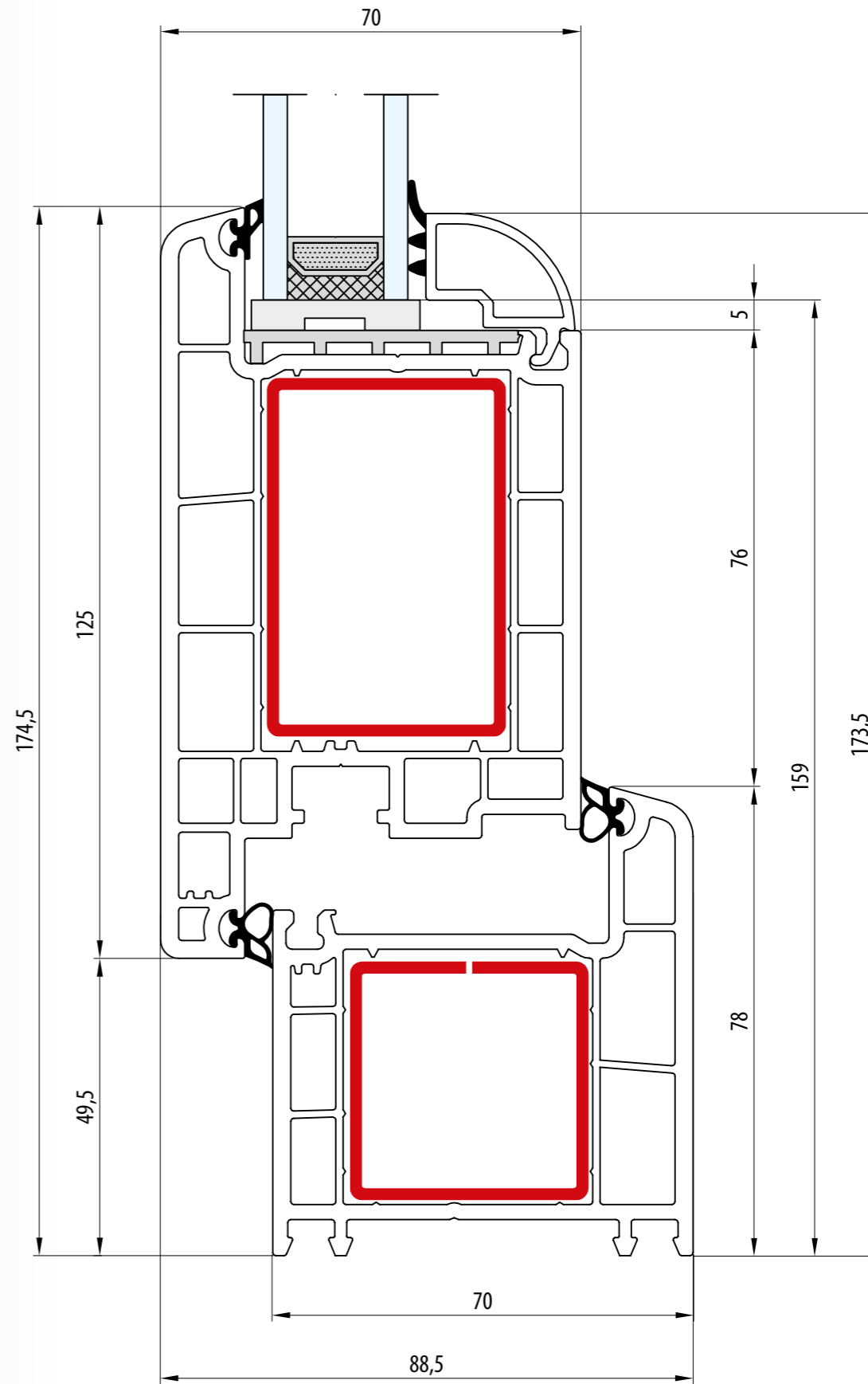

- Rama: 78 mm · Skrzydło: 125 mm
- Dormant: 78 mm · Vantail: 125 mm
- Frame: 78 mm · Sash: 125 mm
- Rahmen: 78 mm · Flügel: 125 mm
- Telaio: 78 mm · Anta: 125 mm

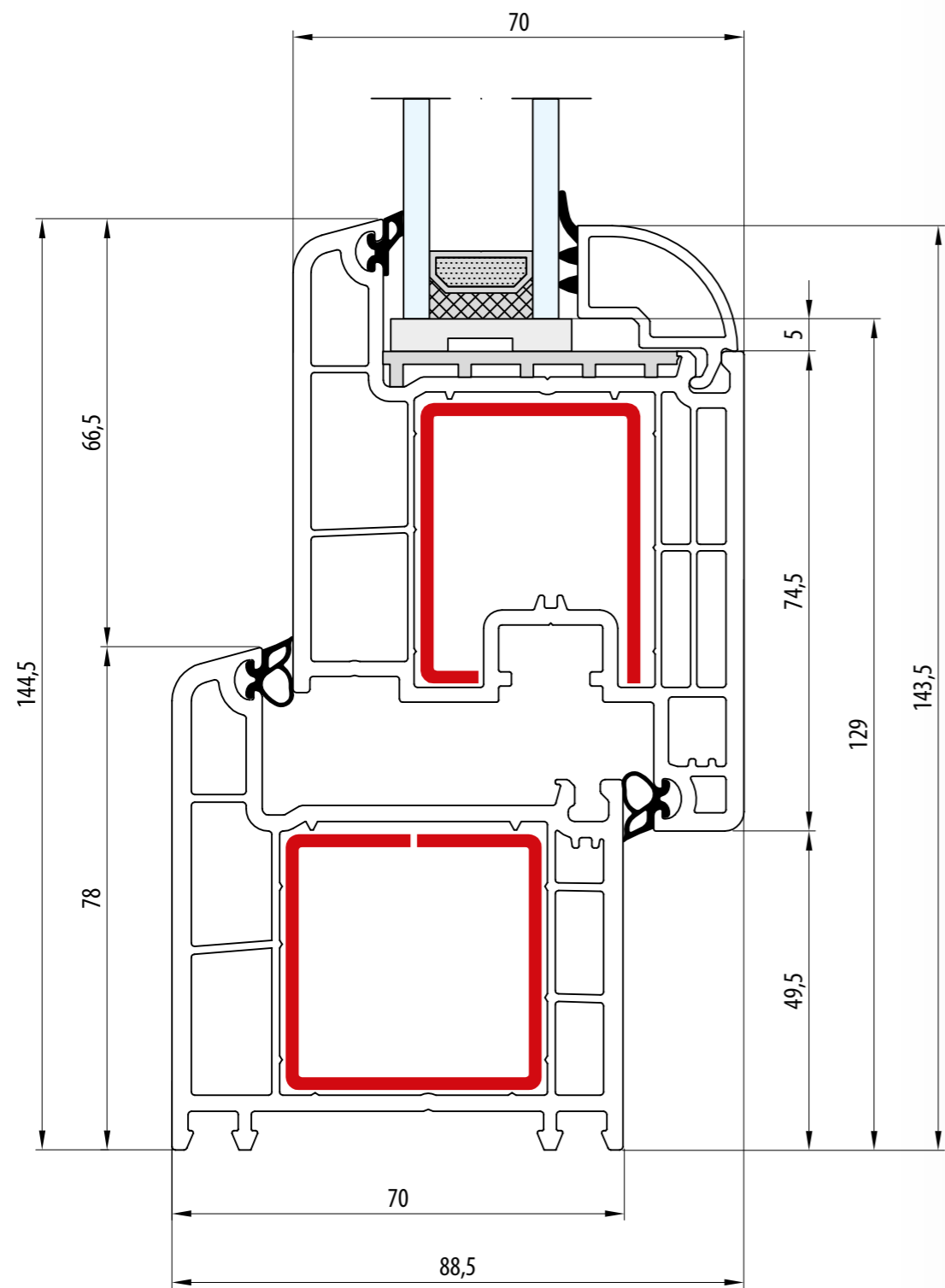

- Rama: 78 mm · Skrzydło: 95 mm
- Dormant: 78 mm · Vantail: 95 mm
- Frame: 78 mm · Sash: 95 mm
- Rahmen: 78 mm · Flügel: 95 mm
- Telaio: 78 mm · Anta: 95 mm

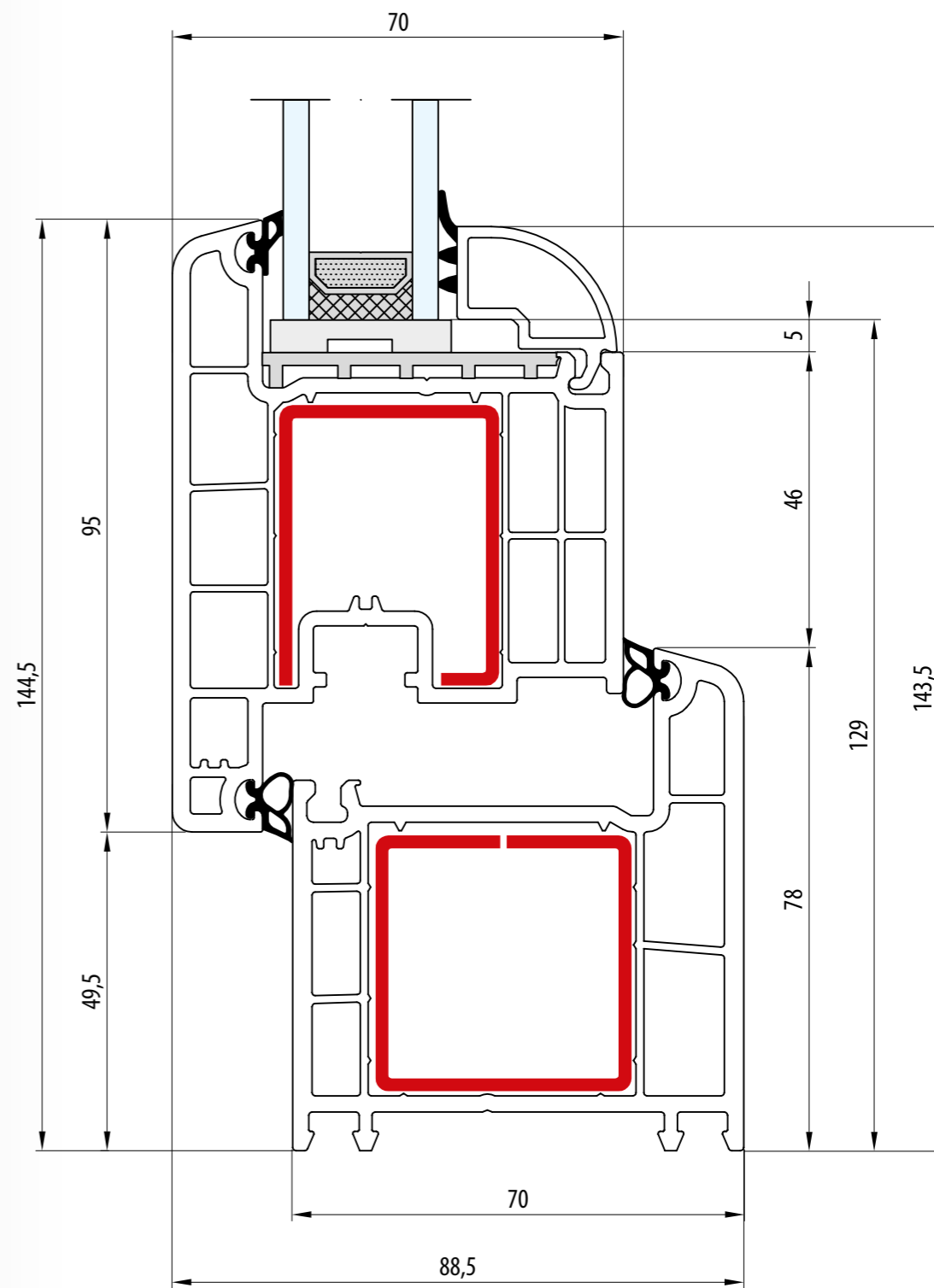
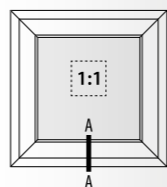

- Rama: 78 mm · Skrzydło: 95 mm
- Dormant: 78 mm · Vantail: 95 mm
- Frame: 78 mm · Sash: 95 mm
- Rahmen: 78 mm · Flügel: 95 mm
- Telaio: 78 mm · Anta: 95 mm

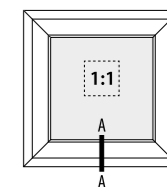

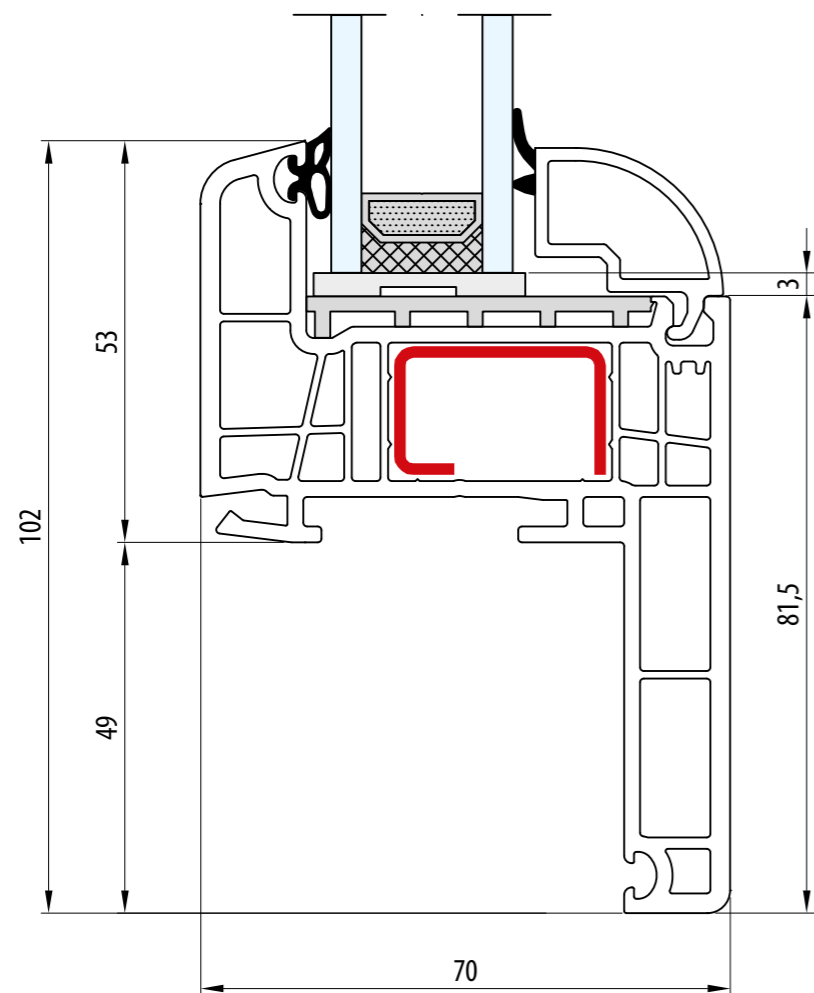

- RENOWACJA - Pletwa: 49 mm · Rama: 53 mm
- RÉNOVATION - Lip: 49 mm · Dormant: 53 mm
- RENOVATION - Strip: 49 mm · Frame: 53 mm
- RENOVIERUNG - Flosse: 49 mm · Rahmen: 53 mm
- RINNOVAZIONE - Aletta da: 49 mm · Telaio: 53 mm

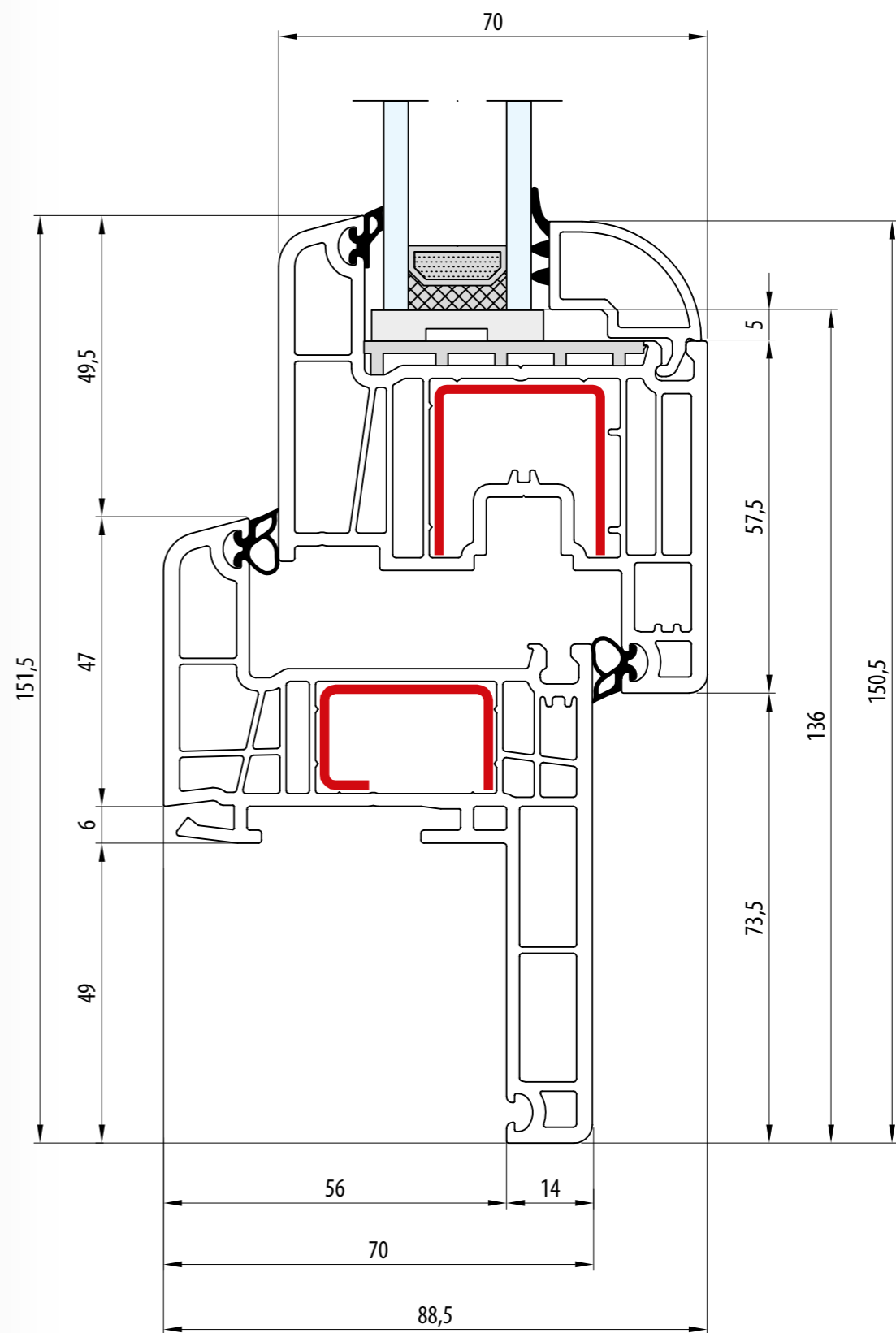
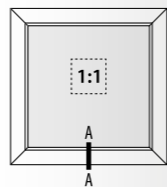

- RENOWACJA - Pletwa: 49 mm · Rama: 53 mm · Skrzydło: 77 mm
- RÉNOVATION - Lip: 49 mm · Dormant: 53 mm · Vantail: 77 mm
- RENOVATION - Strip: 49 mm · Frame: 53 mm · Sash: 77 mm
- RENOVIERUNG - Flosse: 49 mm · Rahmen: 53 mm · Flügel: 77 mm
- RINNOVAZIONE - Aletta da: 49 mm · Telaio: 53 mm · Anta: 77 mm

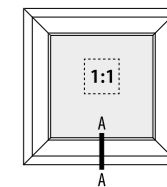

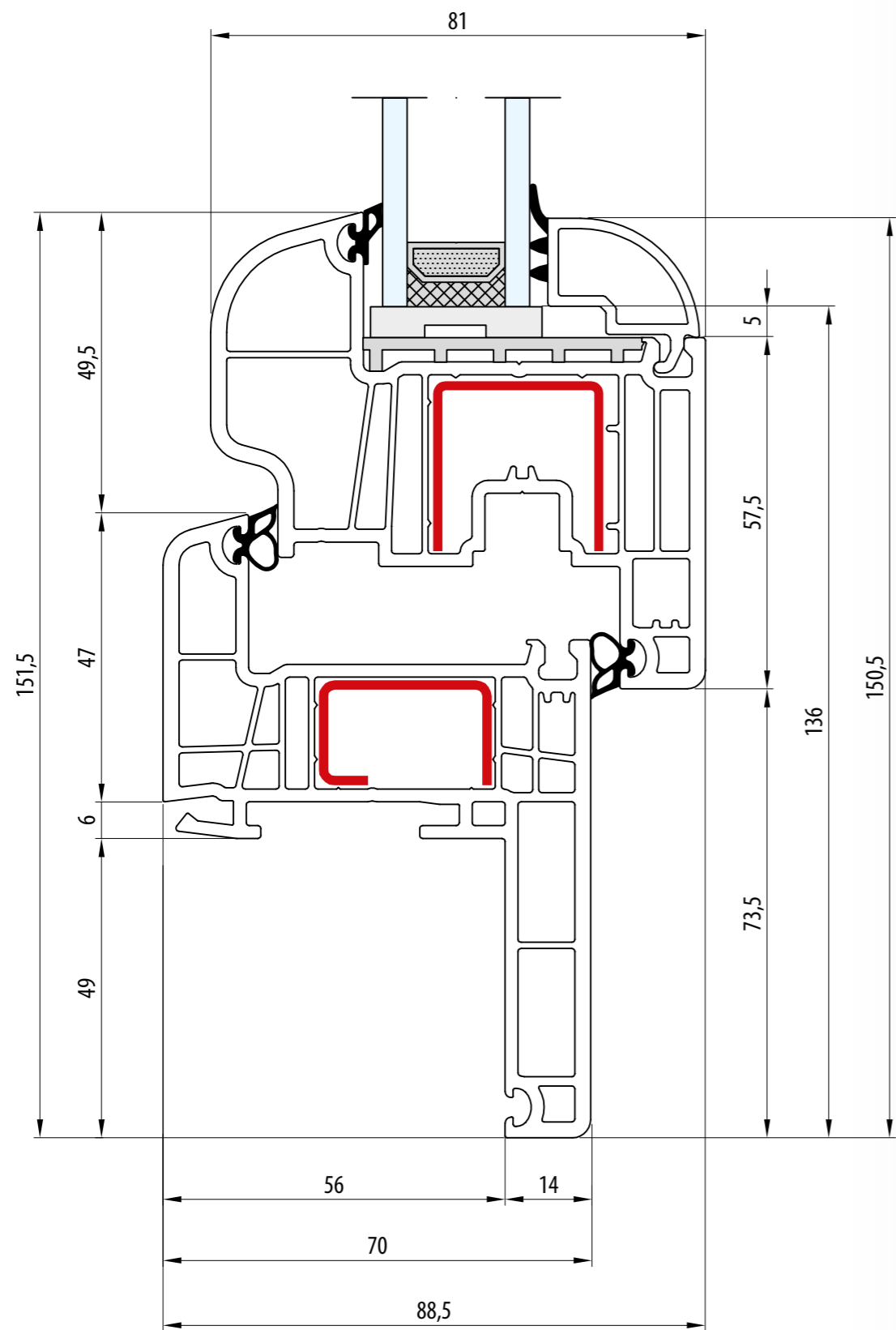

- RENOWACJA - Pletwa: 49 mm · Rama: 53 mm · Skrzydło: 77 mm
- RÉNOVATION - Lip: 49 mm · Dormant: 53 mm · Vantail: 77 mm
- RENOVATION - Strip: 49 mm · Frame: 53 mm · Sash: 77 mm
- RENOVIERUNG - Flosse: 49 mm · Rahmen: 53 mm · Flügel: 77 mm
- RINNOVAZIONE - Aletta da: 49 mm · Telaio: 53 mm · Anta: 77 mm

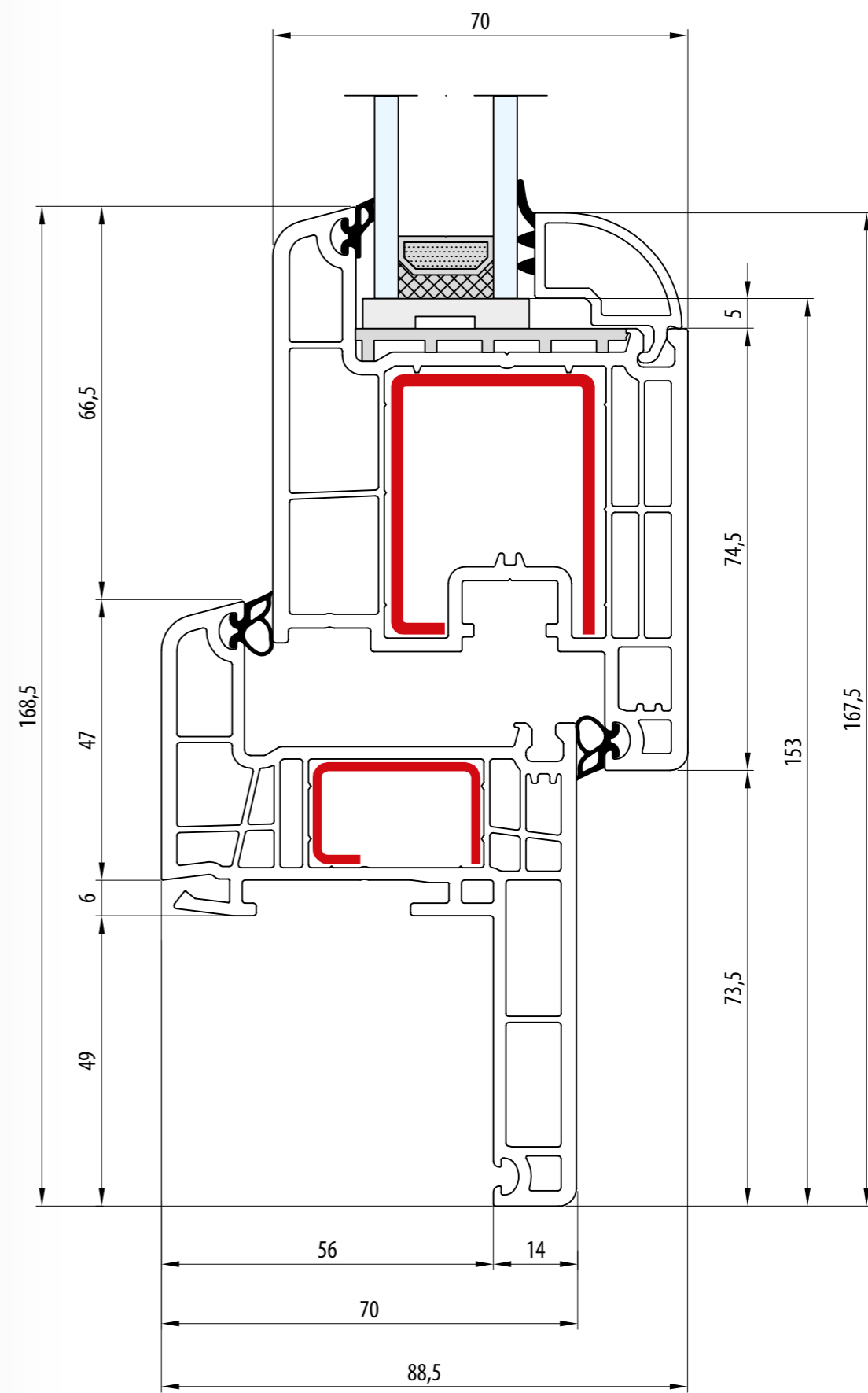
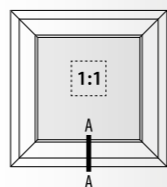

- RENOWACJA - Pletwa: 49 mm · Rama: 53 mm · Skrzydło: 95 mm
- RÉNOVATION - Lip: 49 mm · Dormant: 53 mm · Vantail: 95 mm
- RENOVATION - Strip: 49 mm · Frame: 53 mm · Sash: 95 mm
- RENOVIERUNG - Flosse: 49 mm · Rahmen: 53 mm · Flügel: 95 mm
- RINNOVAZIONE - Aletta da: 49 mm · Telaio: 53 mm · Anta: 95 mm

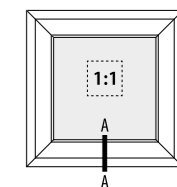

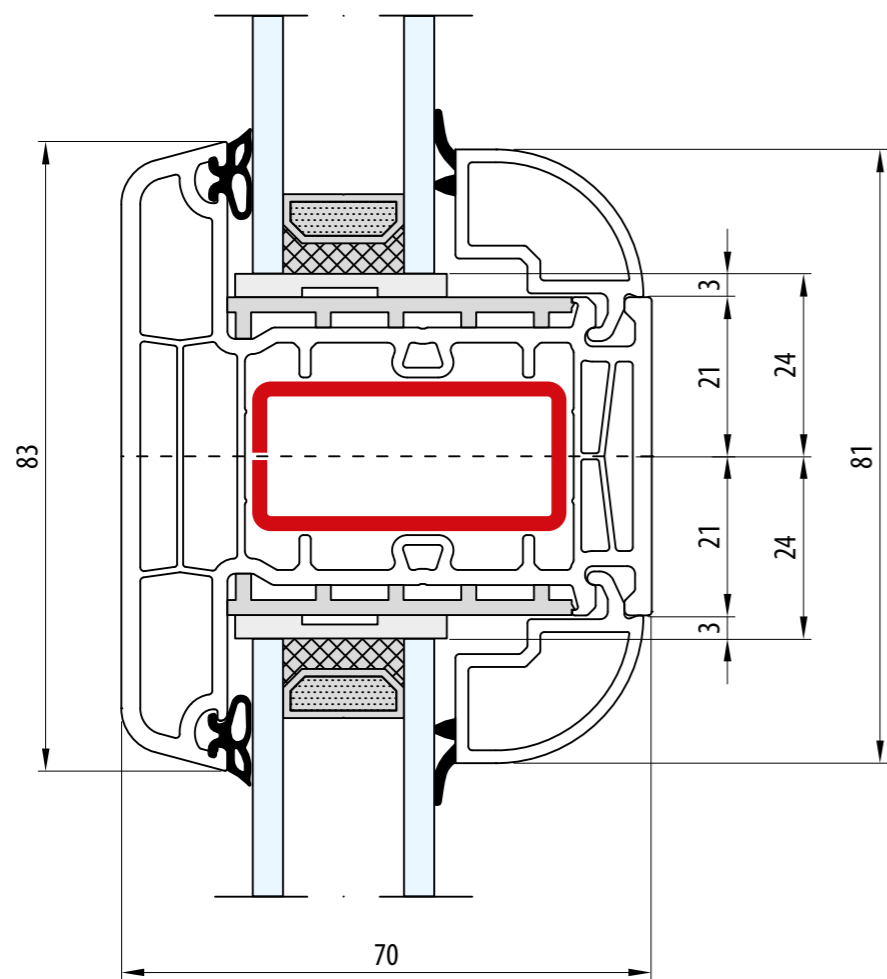

- Słupek stalowy: 83 mm
- Meneau fixe: 83 mm
- Fix post: 83 mm
- Festem Pfahl: 83 mm
- Montante fisso: 83 mm

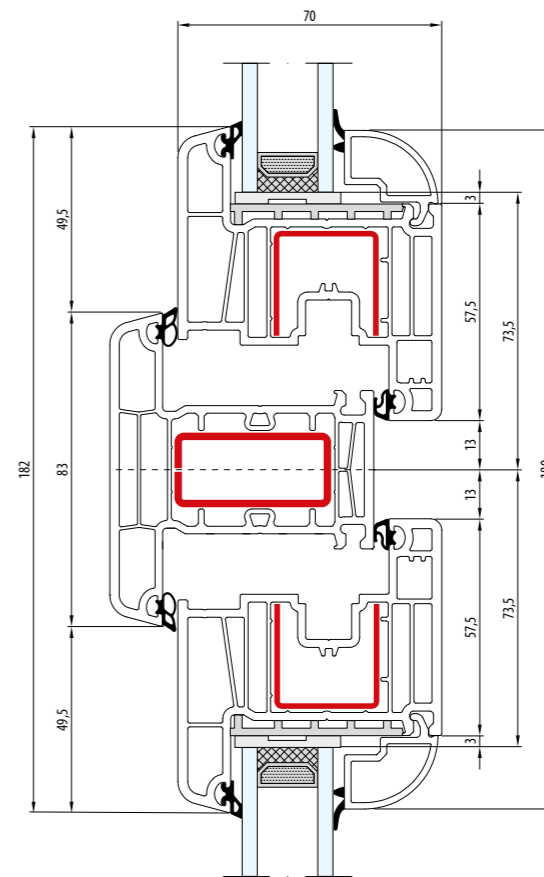
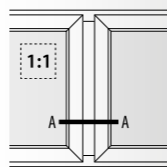

- Słupek stalowy: 83 mm · Skrzydło: 77 mm
- Meneau fixe: 83 mm · Vantail: 77 mm
- Fix post: 83 mm · Sash: 77 mm
- Festem Pfahl: 83 mm · Flügel: 77 mm
- Montante fisso: 83 mm · Anta: 77 mm

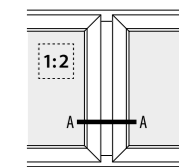

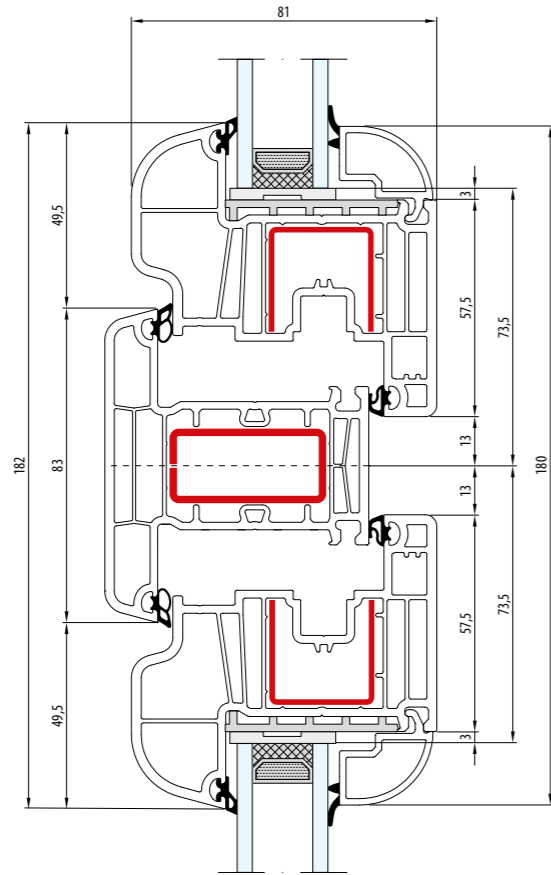

- Słupek stały: 83 mm · Skrzydło: 77 mm
- Meneau fixe: 83 mm · Vantail: 77 mm
- Fix post: 83 mm · Sash: 77 mm
- Festem Pfahl: 83 mm · Flügel: 77 mm
- Montante fisso: 83 mm · Anta: 77 mm

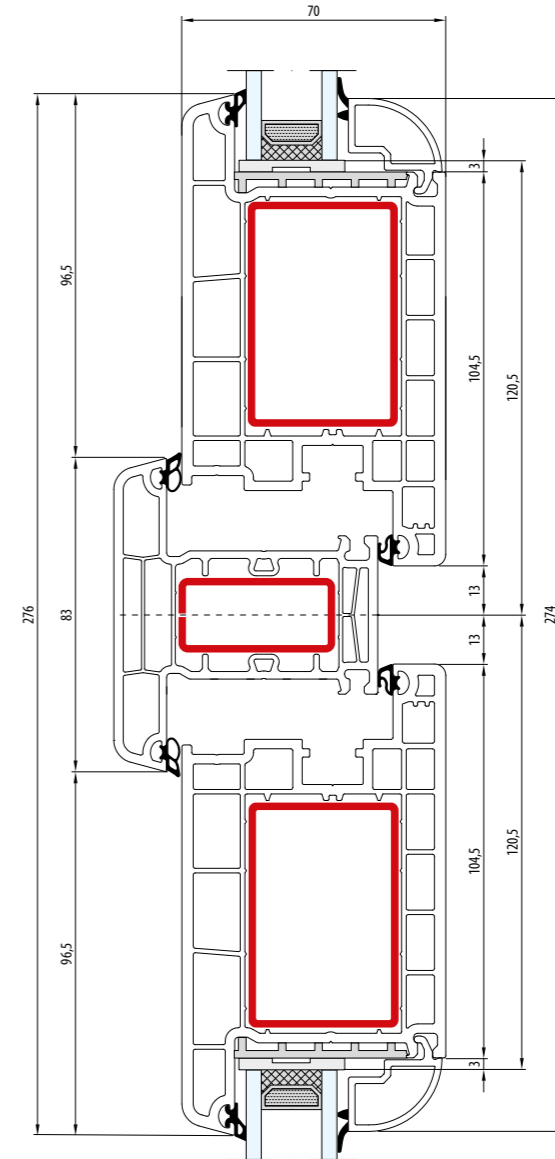
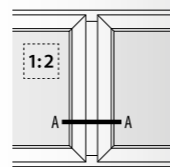

- Słupek stały: 83 mm · Skrzydło: 125 mm
- Meneau fixe: 83 mm · Vantail: 125 mm
- Fix post: 83 mm · Sash: 125 mm
- Festem Pfahl: 83 mm · Flügel: 125 mm
- Montante fisso: 83 mm · Anta: 125 mm

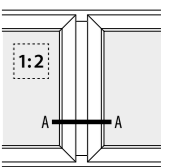

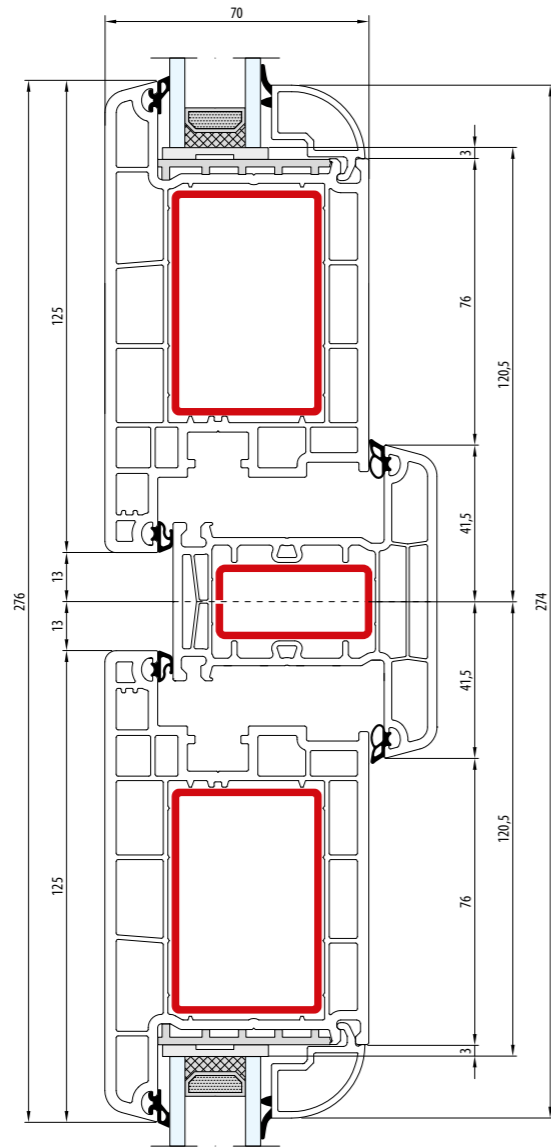

- Słupek stały: 83 mm · Skrzydło: 125 mm
- Meneau fixe: 83 mm · Vantail: 125 mm
- Fix post: 83 mm · Sash: 125 mm
- Festem Pfahl: 83 mm · Flügel: 125 mm
- Montante fisso: 83 mm · Anta: 125 mm

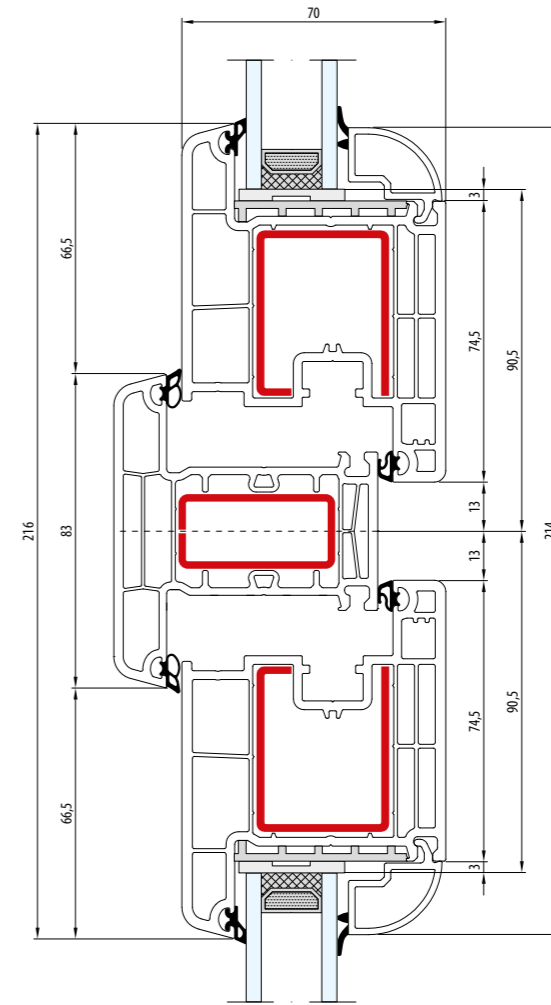
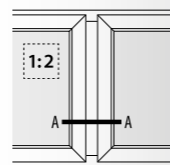

- Słupek stały: 83 mm · Skrzydło: 95 mm
- Meneau fixe: 83 mm · Vantail: 95 mm
- Fix post: 83 mm · Sash: 95 mm
- Festem Pfahl: 83 mm · Flügel: 95 mm
- Montante fisso: 83 mm · Anta: 95 mm

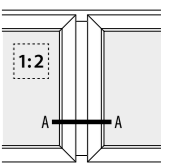

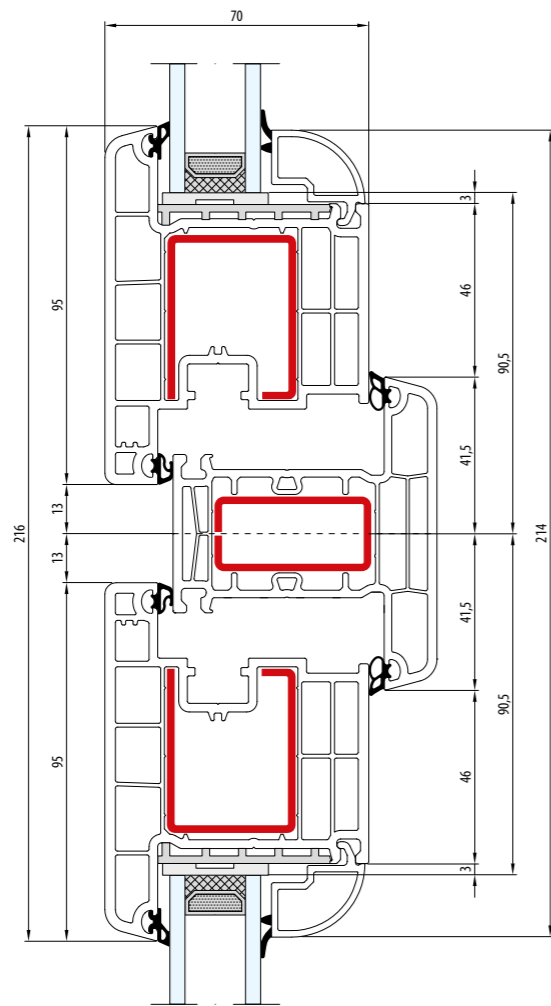

- Słupek stały: 83 mm · Skrzydło: 95 mm
- Meneau fixe: 83 mm · Vantail: 95 mm
- Fix post: 83 mm · Sash: 95 mm
- Festem Pfahl: 83 mm · Flügel: 95 mm
- Montante fisso: 83 mm · Anta: 95 mm

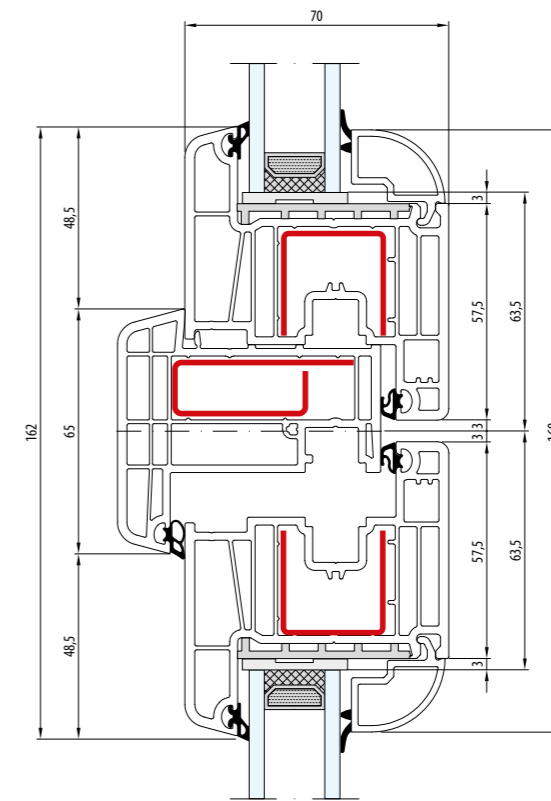
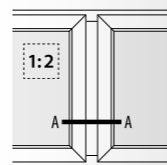

- Słupek ruchomy: 65 mm · Skrzydło: 77 mm
- Meneau mobile: 65 mm · Vantail: 77 mm
- Movable post: 65 mm · Sash: 77 mm
- Stulp: 65 mm · Flügel: 77 mm
- Montante mobile: 65 mm · Anta: 77 mm

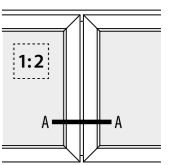

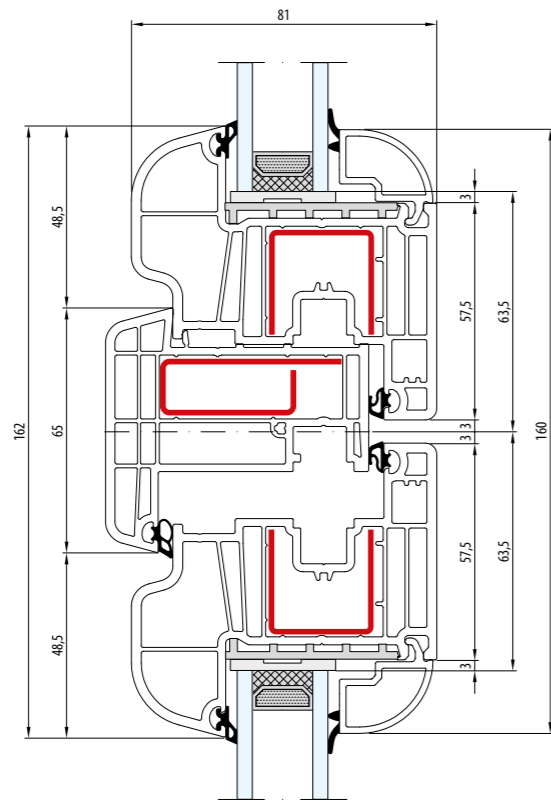

- Słupek ruchomy: 65 mm · Skrzydło: 77 mm
- Meneau mobile: 65 mm · Vantail: 77 mm
- Movable post: 65 mm · Sash: 77 mm
- Stulp: 65 mm · Flügel: 77 mm
- Montante mobile: 65 mm · Anta: 77 mm

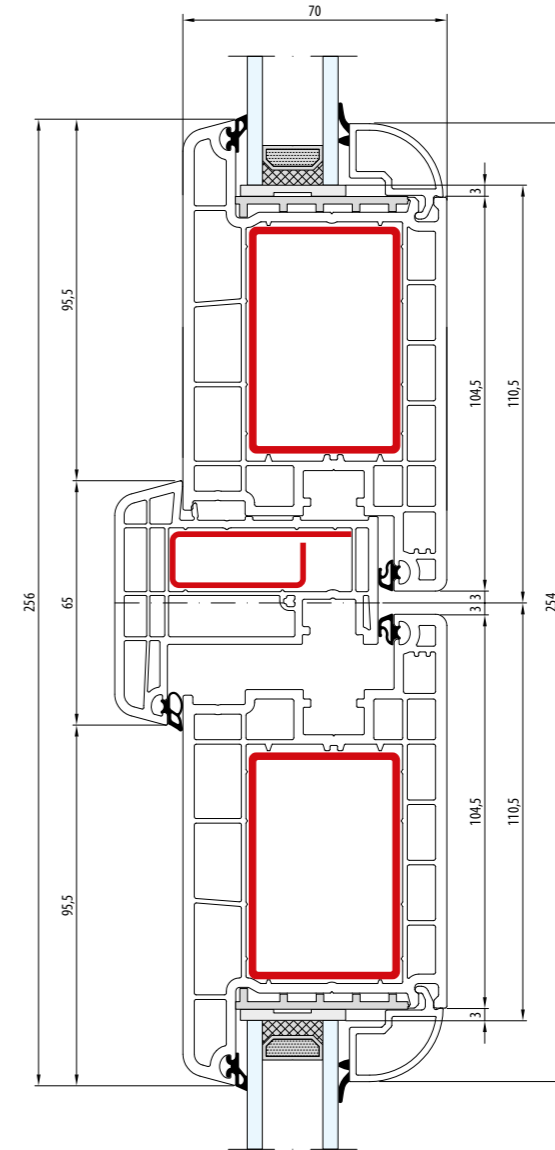
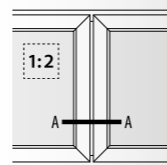

- Słupek ruchomy: 65 mm · Skrzydło: 125 mm
- Meneau mobile: 65 mm · Vantail: 125 mm
- Movable post: 65 mm · Sash: 125 mm
- Stulp: 65 mm · Flügel: 125 mm
- Montante mobile: 65 mm · Anta: 125 mm

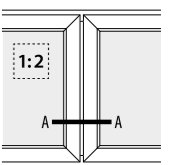

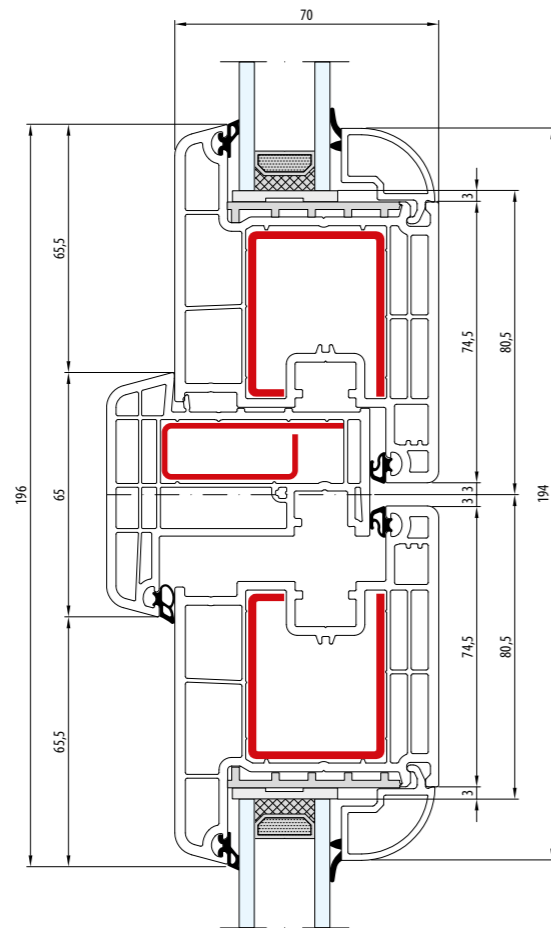

- Słupek ruchomy: 65 mm · Skrzydło: 95 mm
- Meneau mobile: 65 mm · Vantail: 95 mm
- Movable post: 65 mm · Sash: 95 mm
- Stulp: 65 mm · Flügel: 95 mm
- Montante mobile: 65 mm · Anta: 95 mm

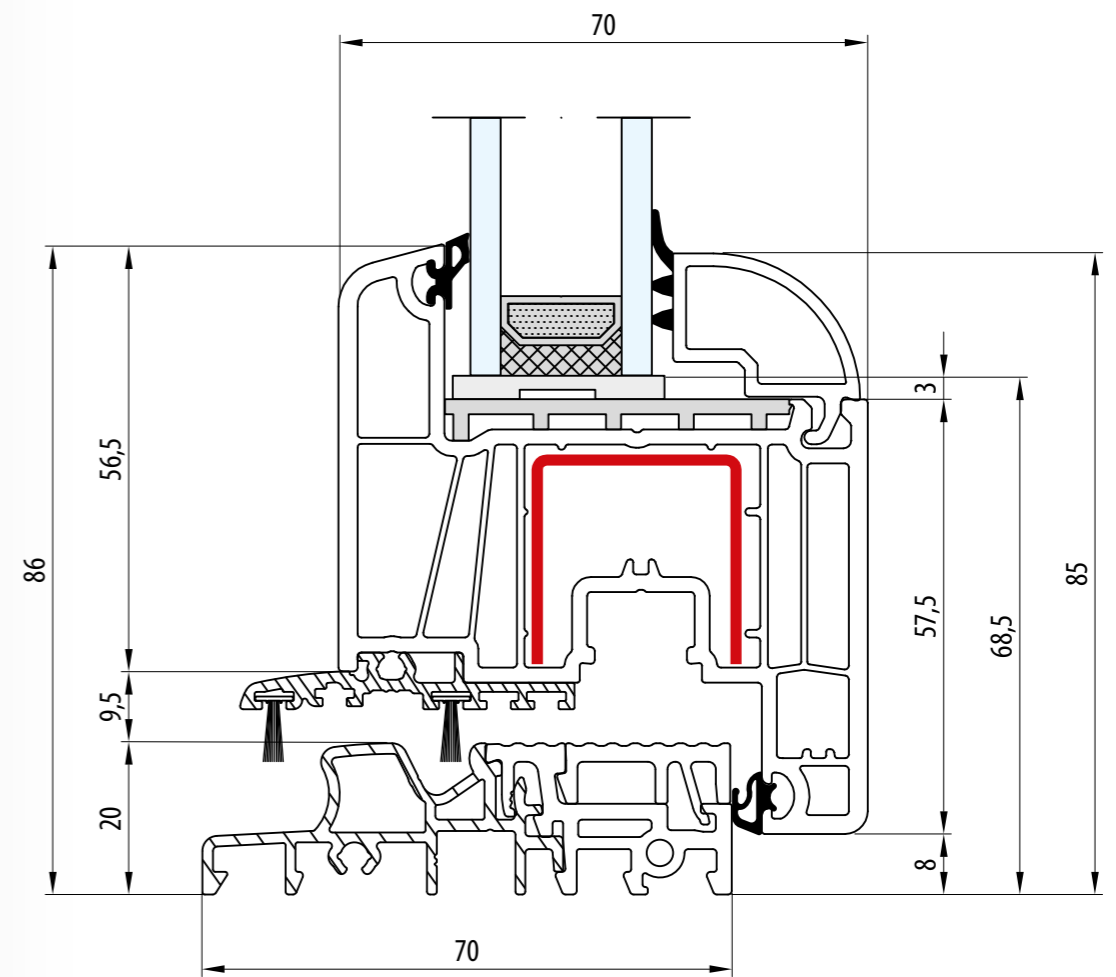
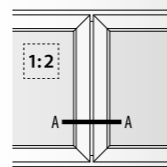

- Próg: 20 mm · Skrzydło: 77 mm
- Seuil: 20 mm · Vantail: 77 mm
- Threshold: 20 mm · Sash: 77 mm
- Schwelle: 20 mm · Flügel: 77 mm
- Soglia: 20 mm · Anta: 77 mm

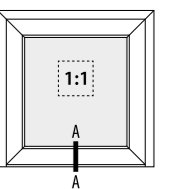

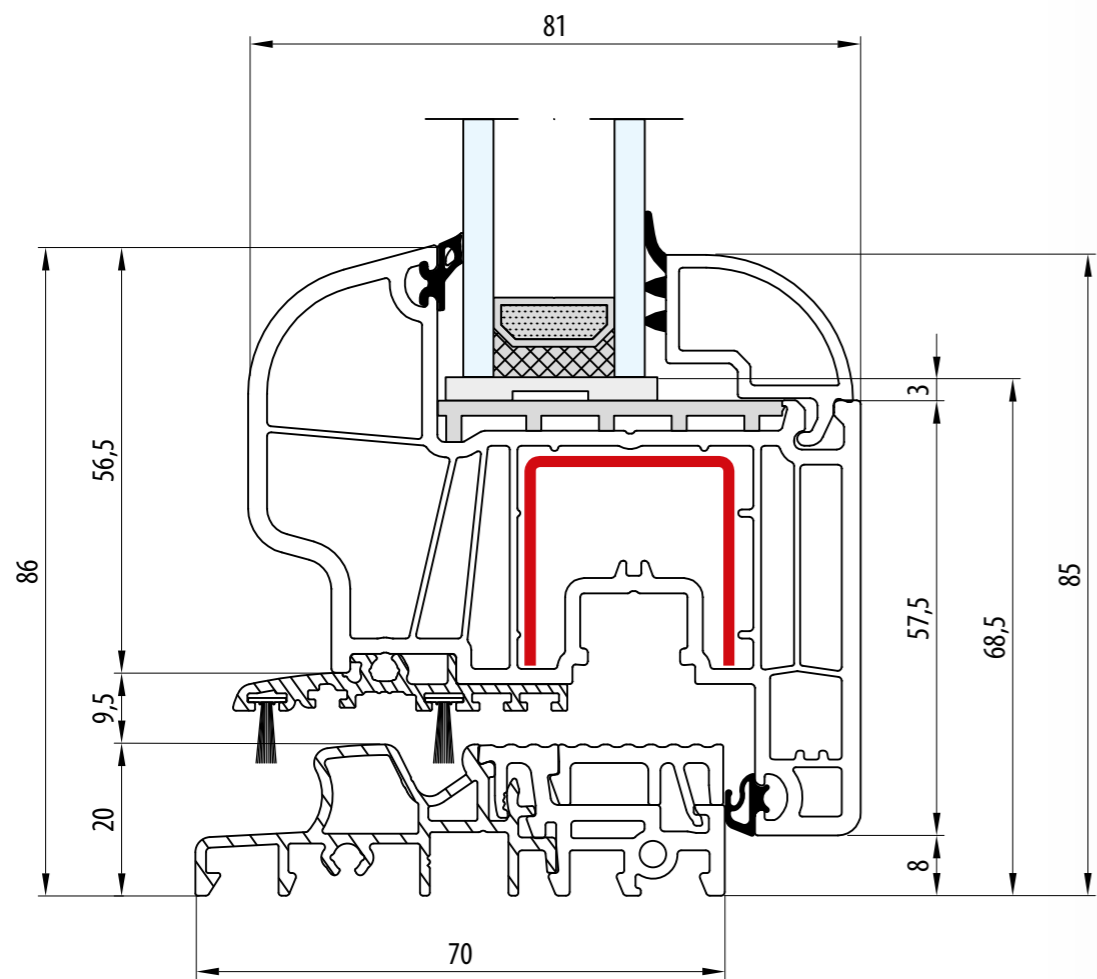

- Próg: 20 mm · Skrzydło: 77 mm
- Seuil: 20 mm · Vantail: 77 mm
- Threshold: 20 mm · Sash: 77 mm
- Schwelle: 20 mm · Flügel: 77 mm
- Soglia: 20 mm · Anta: 77 mm

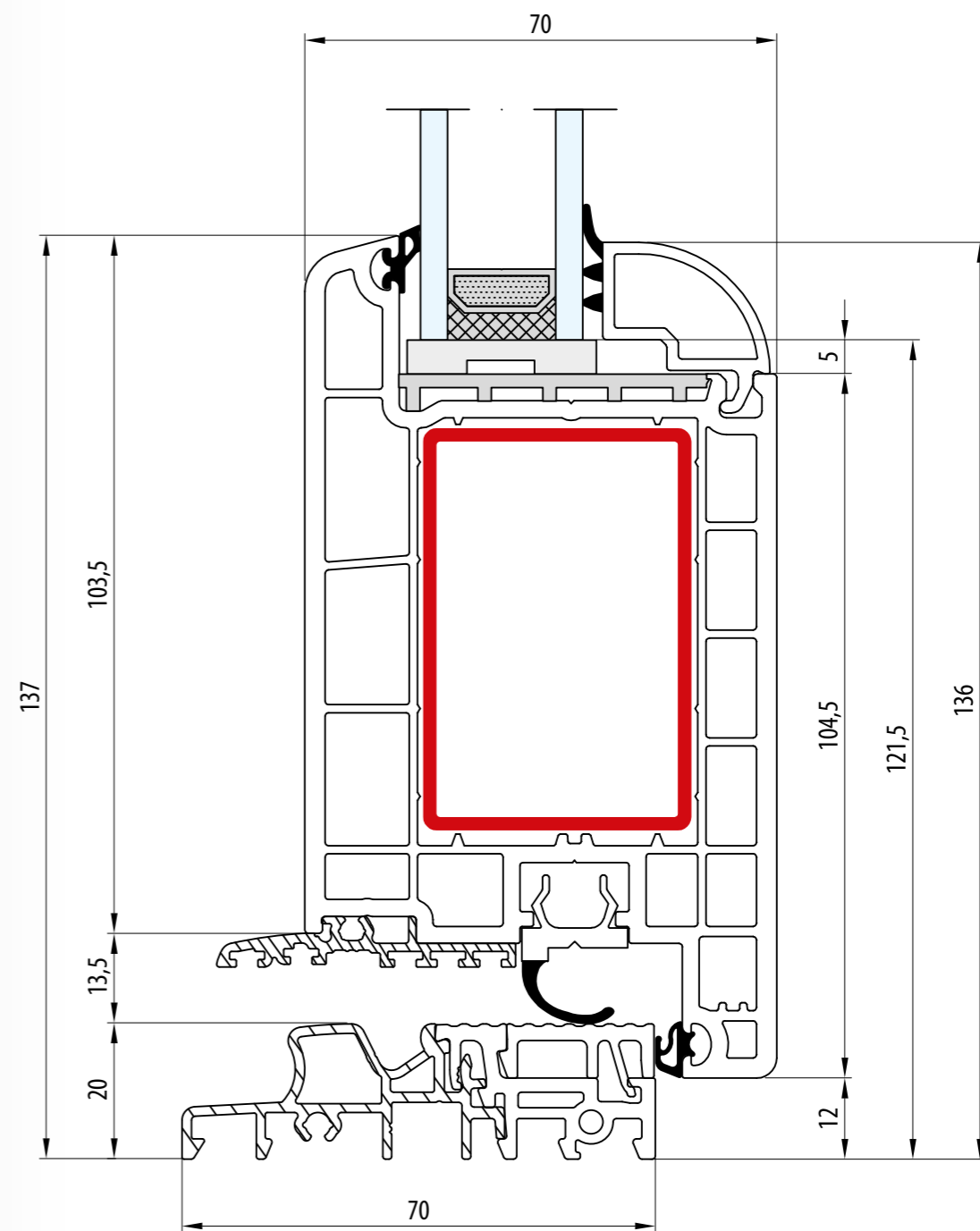
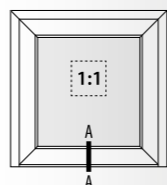

- Próg: 20 mm · Skrzydło: 125 mm
- Seuil: 20 mm · Vantail: 125 mm
- Threshold: 20 mm · Sash: 125 mm
- Schwelle: 20 mm · Flügel: 125 mm
- Soglia: 20 mm · Anta: 125 mm

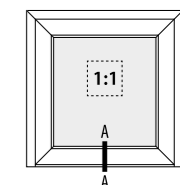

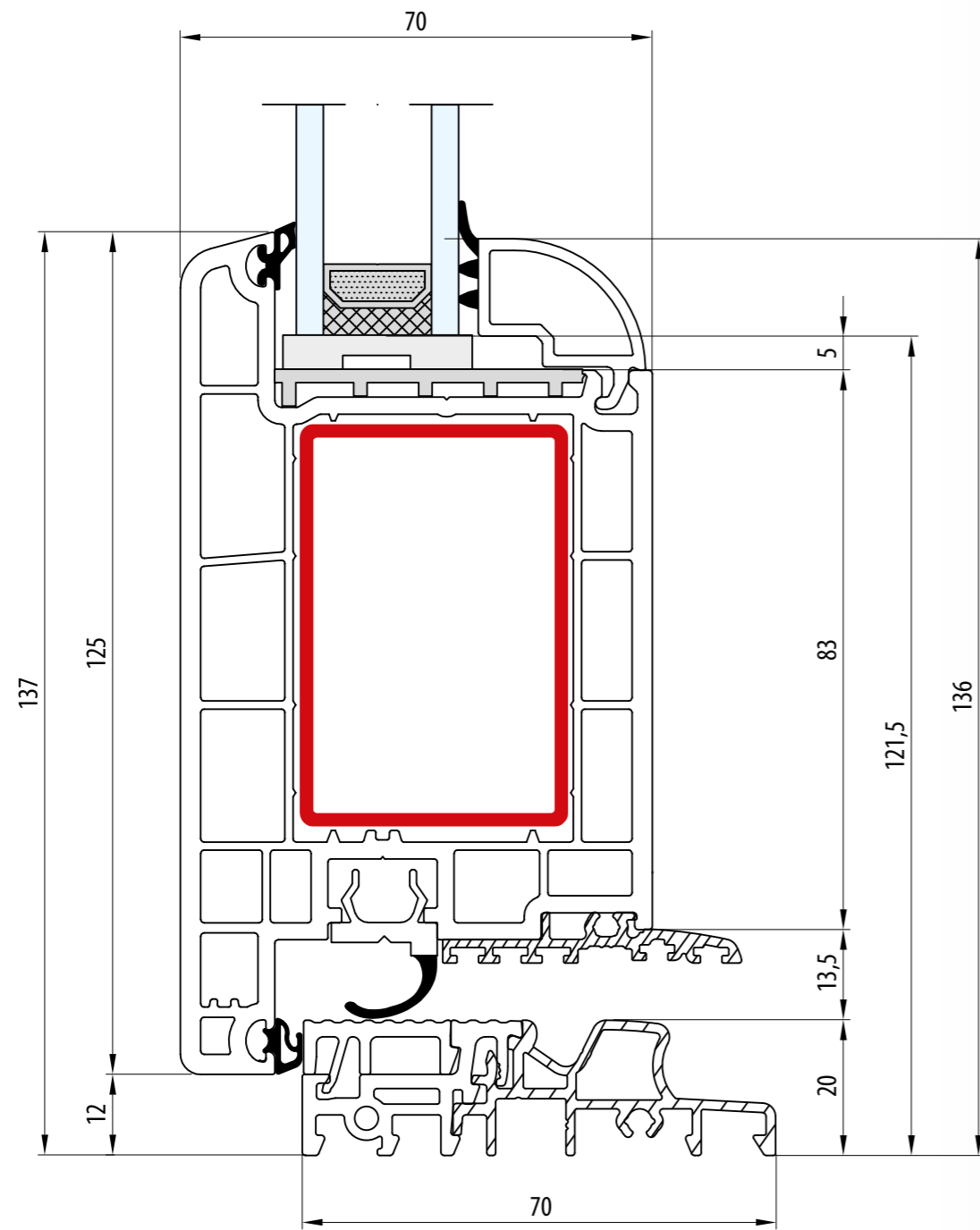

- Próg: 20 mm · Skrzydło: 125 mm
- Seuil: 20 mm · Vantail: 125 mm
- Threshold: 20 mm · Sash: 125 mm
- Schwelle: 20 mm · Flügel: 125 mm
- Soglia: 20 mm · Anta: 125 mm

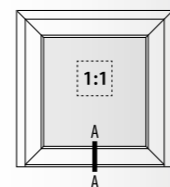

EKOSUN 6

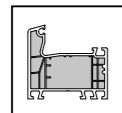

6



2

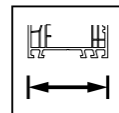

81

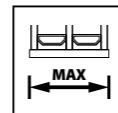

55

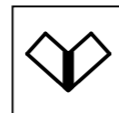

V SUPER SOLUTION



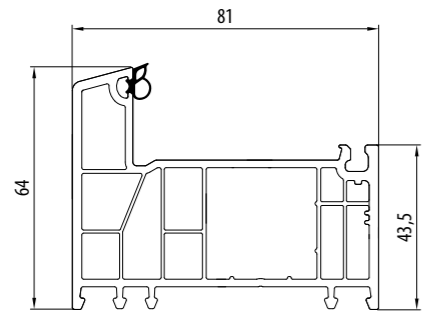

8210

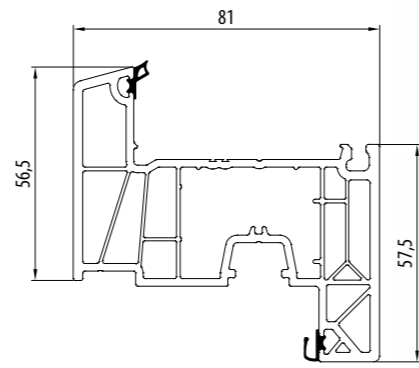

8220

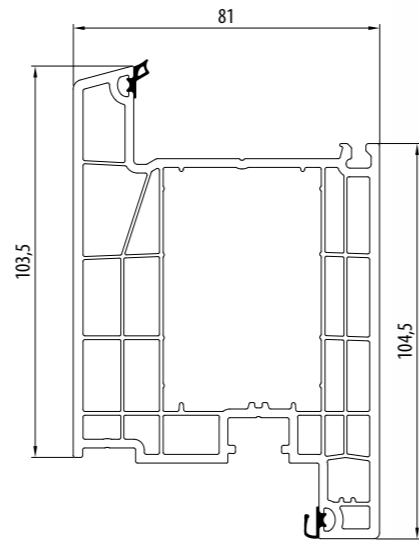

8224

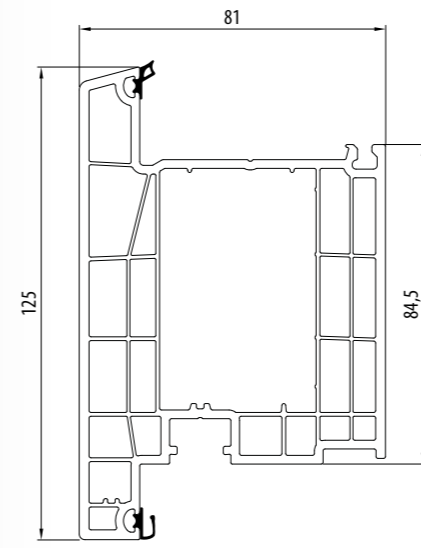

8225

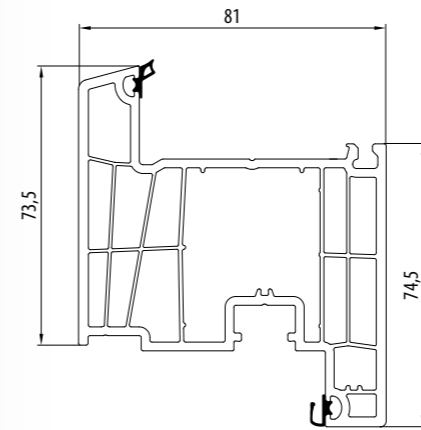

8226

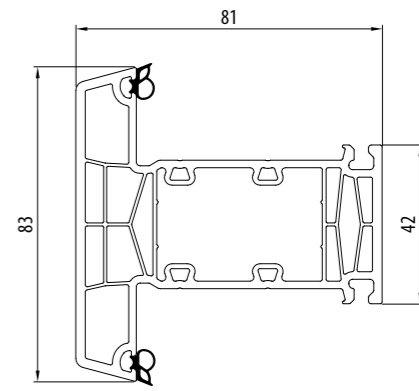

8230

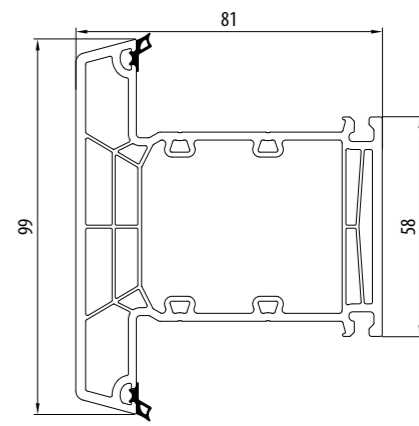

8236

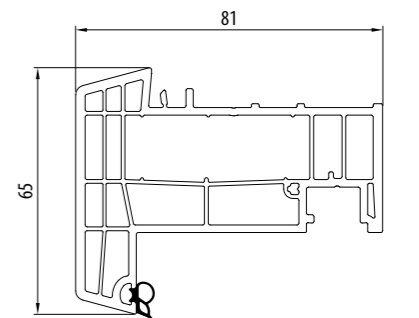

8232

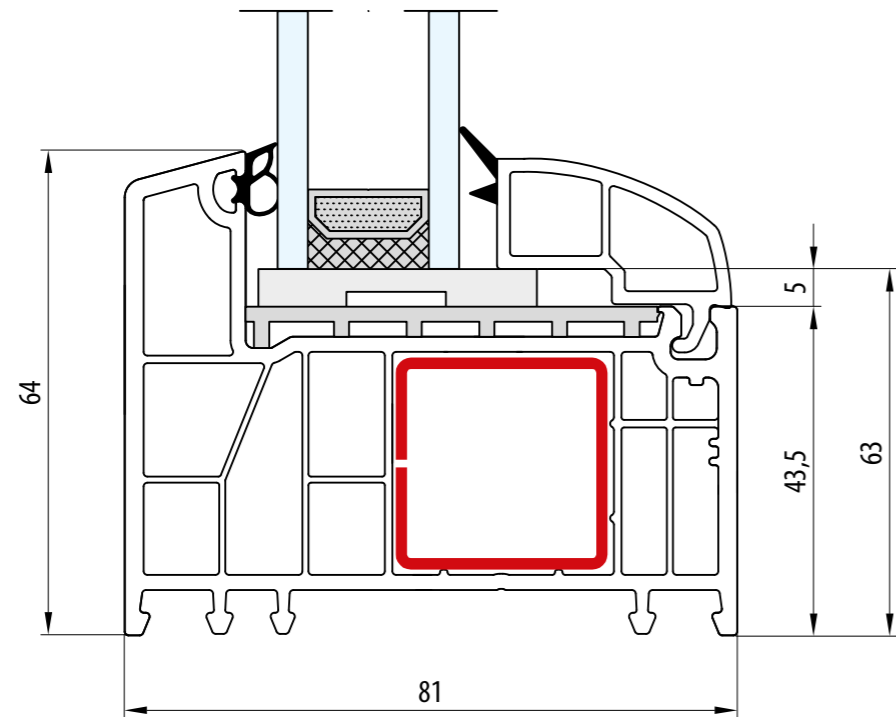

- Rama: 64 mm
- Dormant: 64 mm
- Frame: 64 mm
- Rahmen: 64 mm
- Telaio: 64 mm

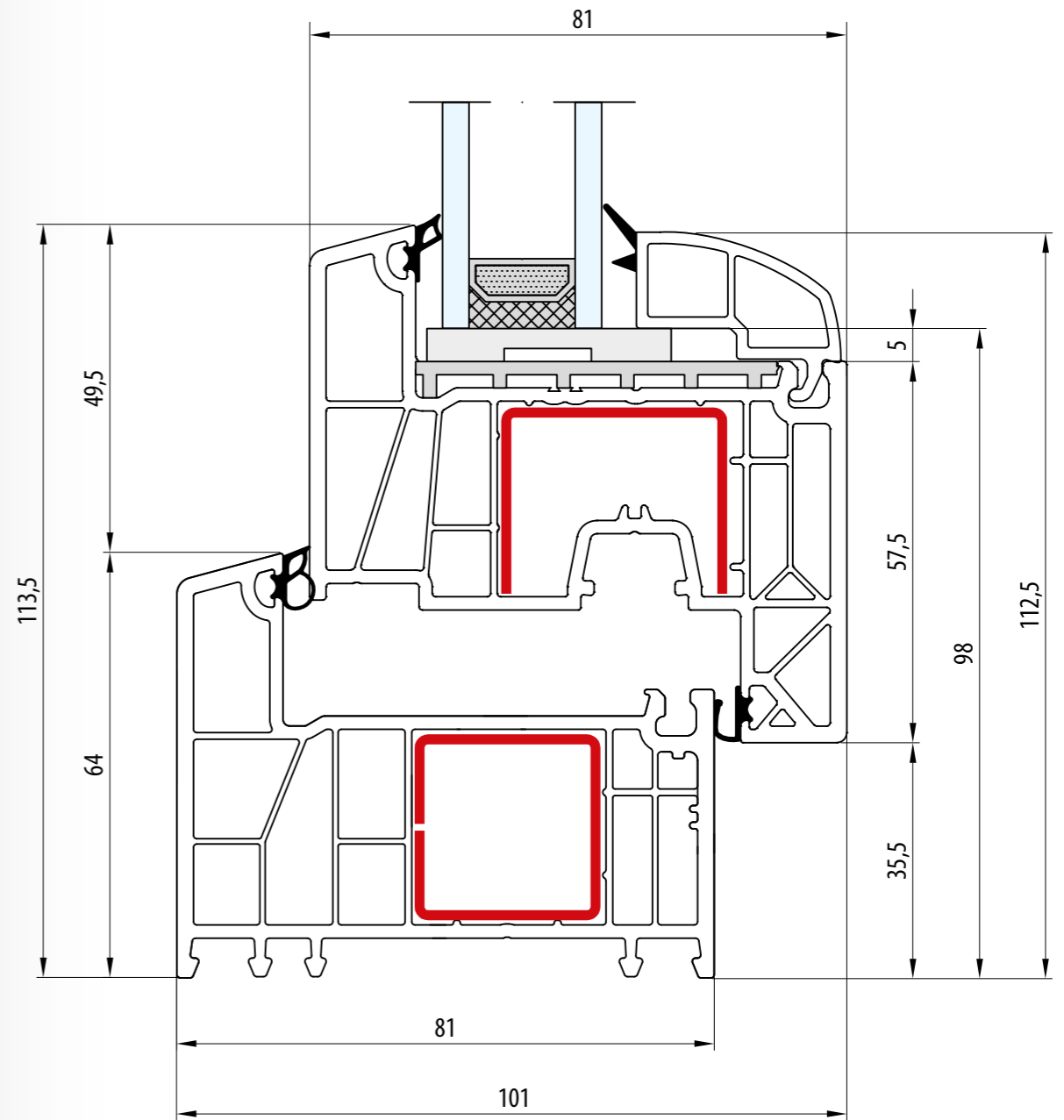
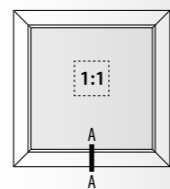

- Rama: 64 mm · Skrzydło: 77 mm
- Dormant: 64 mm · Vantail: 77 mm
- Frame: 64 mm · Sash: 77 mm
- Rahmen: 64 mm · Flügel: 77 mm
- Telaio: 64 mm · Anta: 77 mm

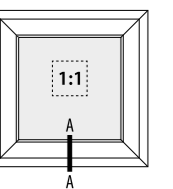

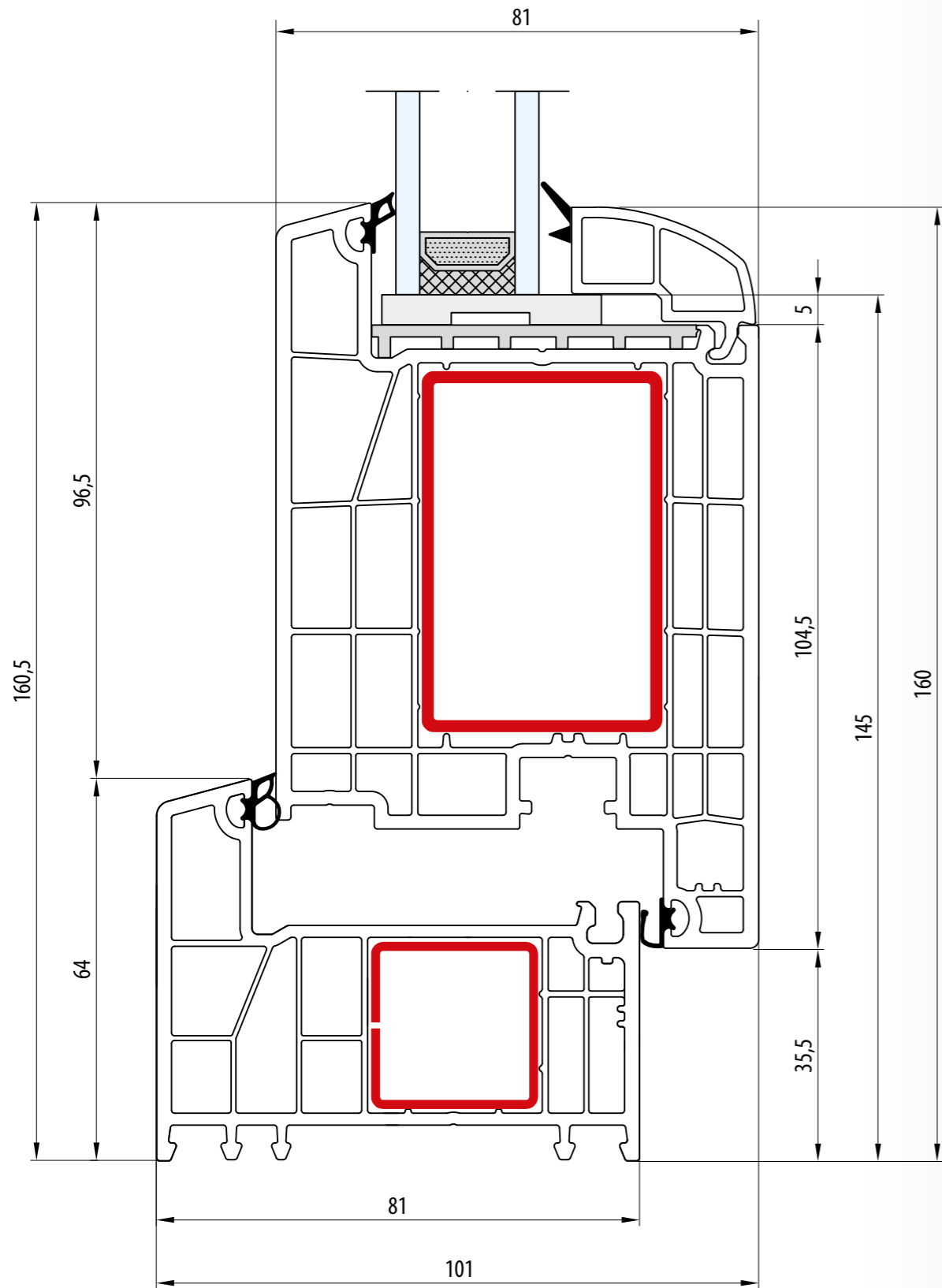

- Rama: 64 mm · Skrzydło: 125 mm
- Dormant: 64 mm · Vantail: 125 mm
- Frame: 64 mm · Sash: 125 mm
- Rahmen: 64 mm · Flügel: 125 mm
- Telaio: 64 mm · Anta: 125 mm

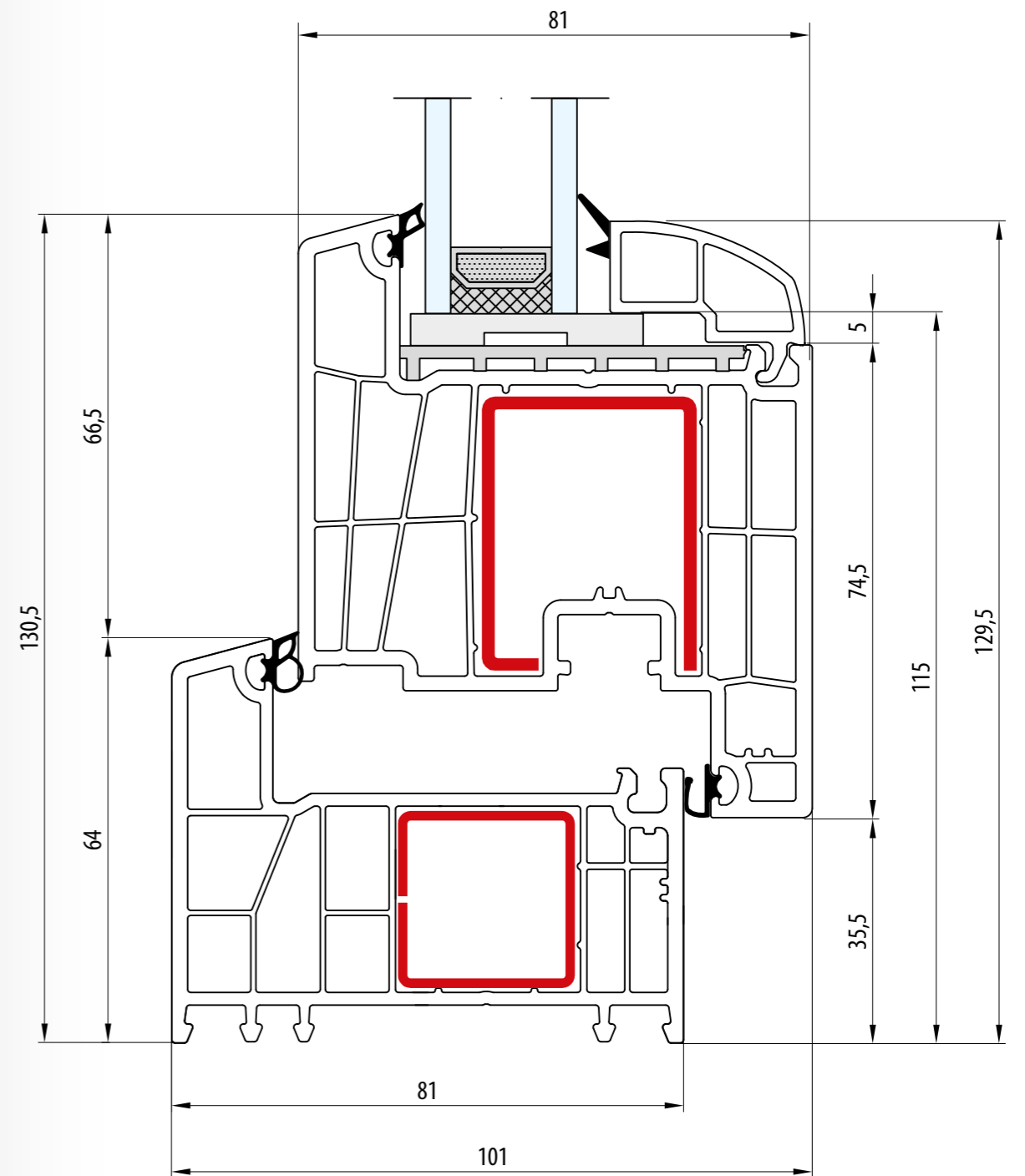
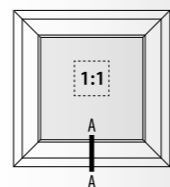

- Rama: 64 mm · Skrzydło: 95 mm
- Dormant: 64 mm · Vantail: 95 mm
- Frame: 64 mm · Sash: 95 mm
- Rahmen: 64 mm · Flügel: 95 mm
- Telaio: 64 mm · Anta: 95 mm

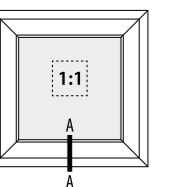

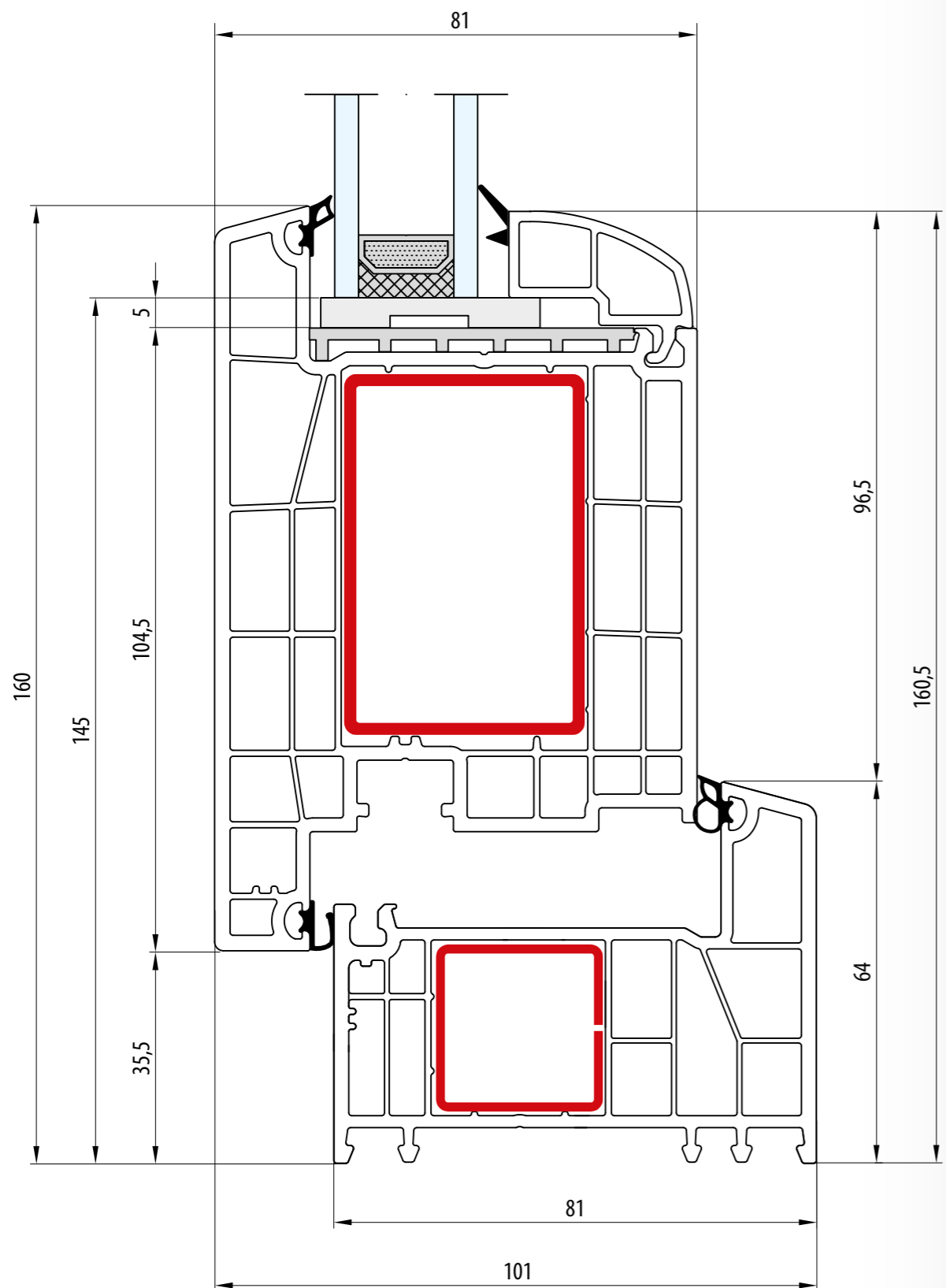

- Rama: 64 mm · Skrzydło: 125 mm
- Dormant: 64 mm · Vantail: 125 mm
- Frame: 64 mm · Sash: 125 mm
- Rahmen: 64 mm · Flügel: 125 mm
- Telaio: 64 mm · Anta: 125 mm

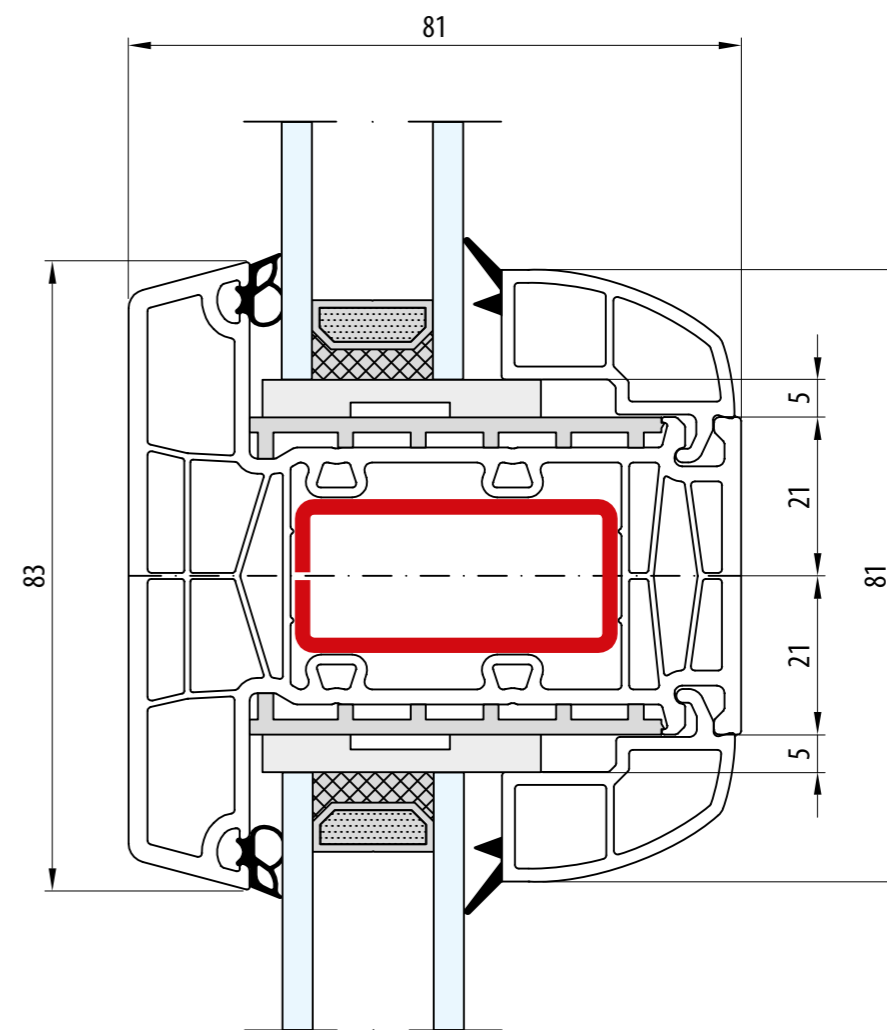
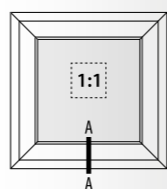

- Słupek staly: 83 mm
- Meneau fixe: 83 mm
- Fix post: 83 mm
- Festem Pfahl: 83 mm
- Montante fisso: 83 mm

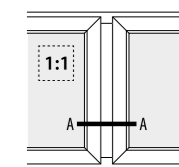

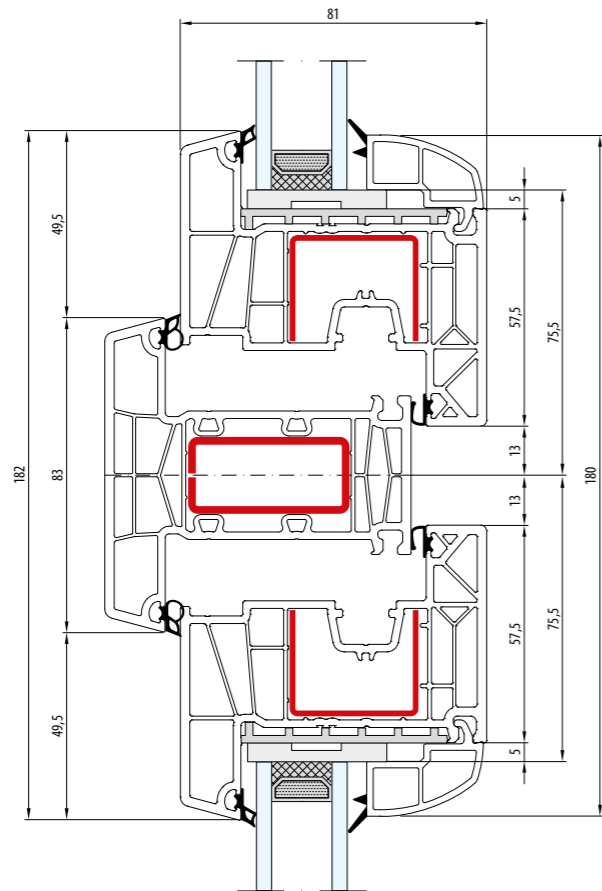



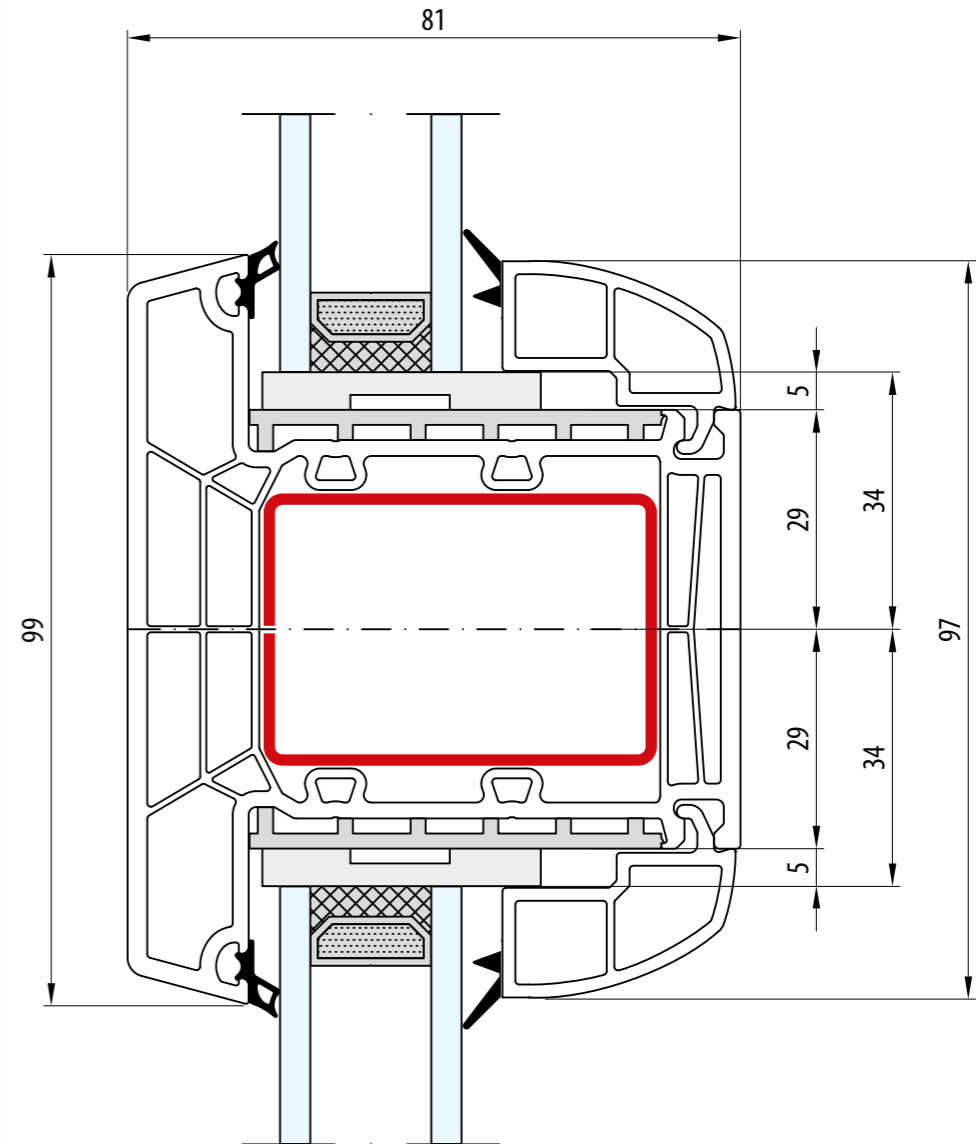
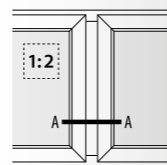

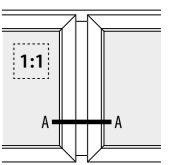

- Słupek stalowy: 83 mm · Skrzydło: 77 mm
- Meneau fixe: 83 mm · Vantail: 77 mm
- Fix post: 83 mm · Sash: 77 mm
- Festem Pfahl: 83 mm · Flügel: 77 mm
- Montante fisso: 83 mm · Anta: 77 mm

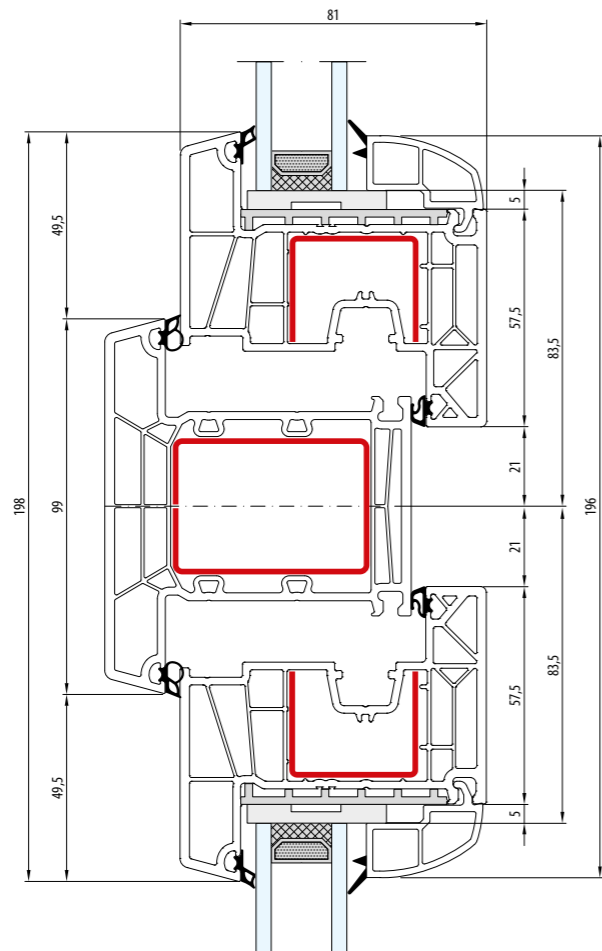







- Słupek stalowy: 99 mm
- Meneau fixe: 99 mm
- Fix post: 99 mm
- Festem Pfahl: 99 mm
- Montante fisso: 99 mm

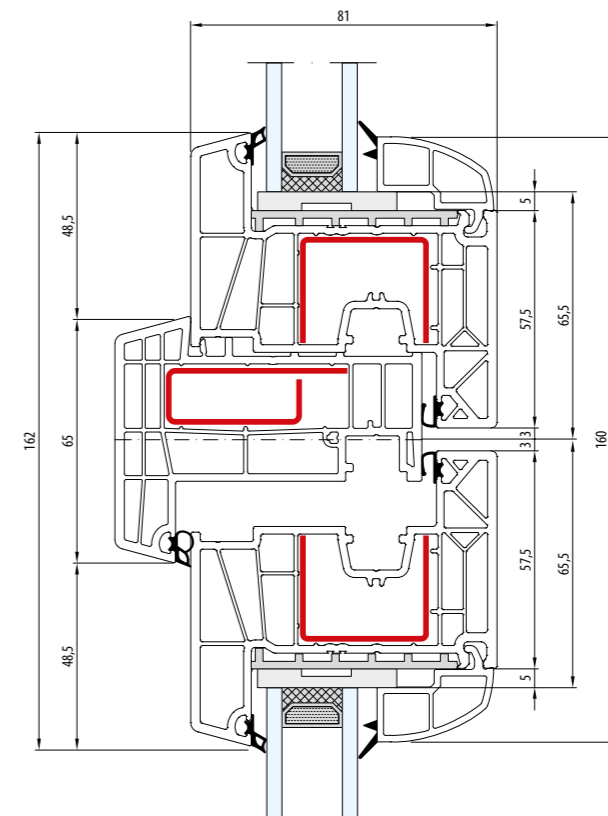
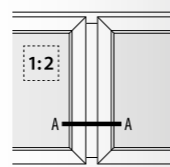



-  Słupek stały: 99 mm · Skrzydło: 77 mm
-  Meneau fixe: 99 mm · Vantail: 77 mm
-  Fix post: 99 mm · Sash: 77 mm
-  Festem Pfahl: 99 mm · Flügel: 77 mm
-  Montante fisso: 99 mm · Anta: 77 mm



-  Słupek ruchomy: 65 mm · Skrzydło: 77 mm
-  Meneau mobile: 65 mm · Vantail: 77 mm
-  Movable post: 65 mm · Sash: 77 mm
-  Stulp: 65 mm · Flügel: 77 mm
-  Montante mobile: 65 mm · Anta: 77 mm

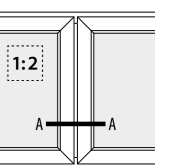

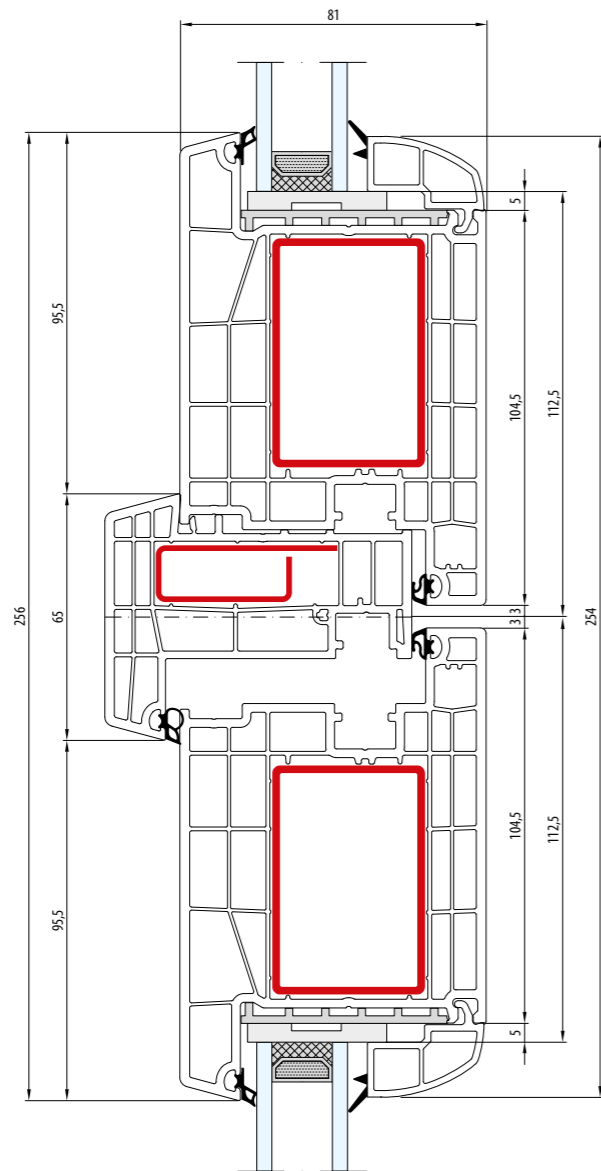

- Słupek ruchomy: 65 mm · Skrzydło: 125 mm
- Meneau mobile: 65 mm · Vantail: 125 mm
- Movable post: 65 mm · Sash: 125 mm
- Stulp: 65 mm · Flügel: 125 mm
- Montante mobile: 65 mm · Anta: 125 mm

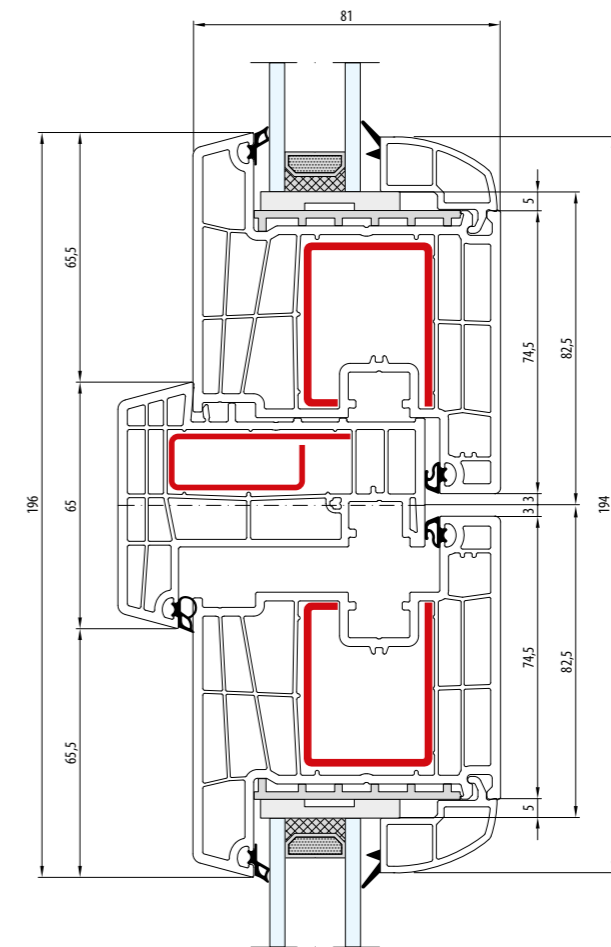
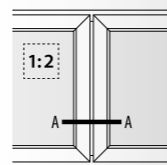

- Słupek ruchomy: 65 mm · Skrzydło: 95 mm
- Meneau mobile: 65 mm · Vantail: 95 mm
- Movable post: 65 mm · Sash: 95 mm
- Stulp: 65 mm · Flügel: 95 mm
- Montante mobile: 65 mm · Anta: 95 mm

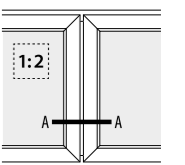

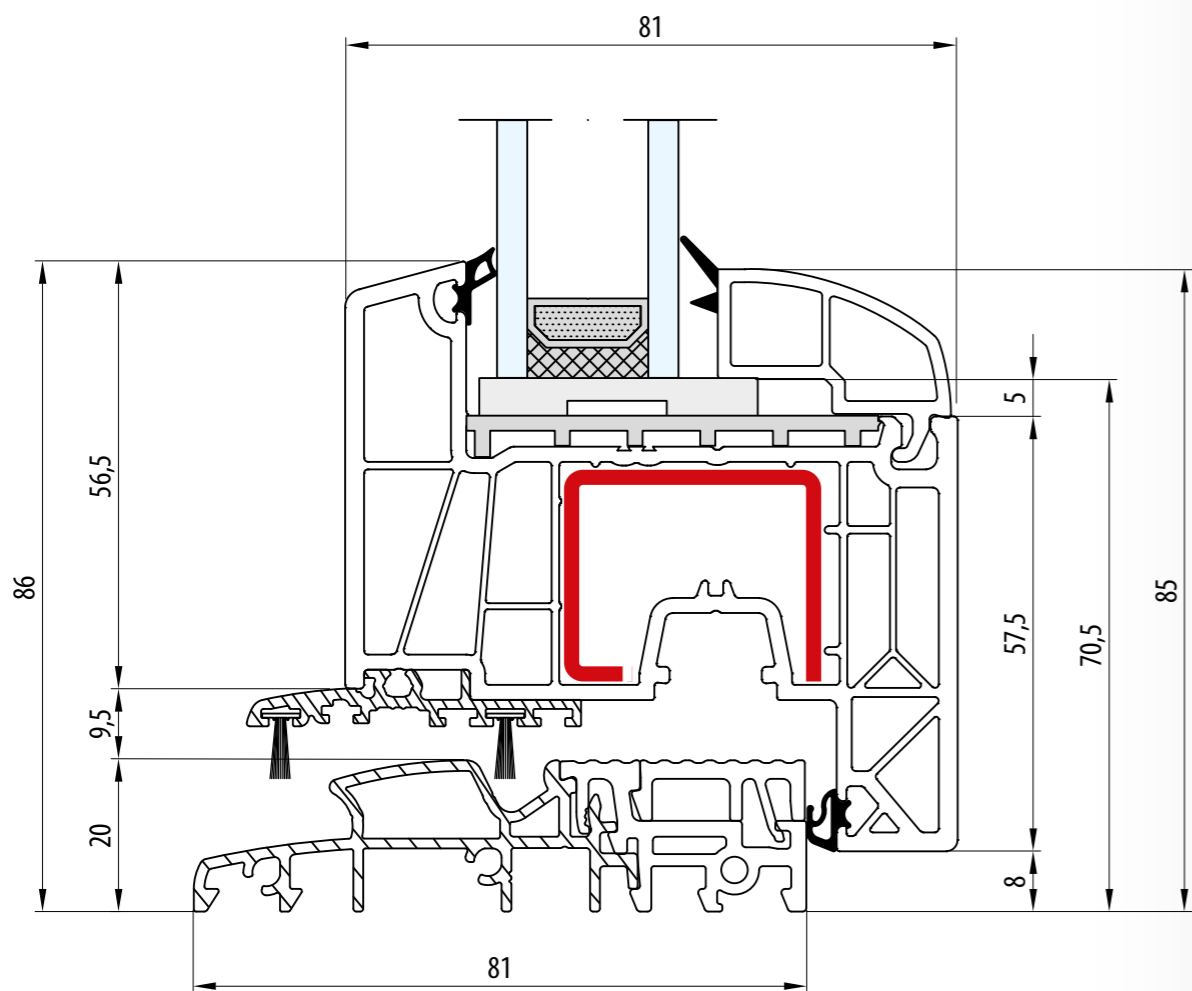

- Próg: 20 mm · Skrzydło: 77 mm
- Seuil: 20 mm · Vantail: 77 mm
- Threshold: 20 mm · Sash: 77 mm
- Schwelle: 20 mm · Flügel: 77 mm
- Soglia: 20 mm · Anta: 77 mm

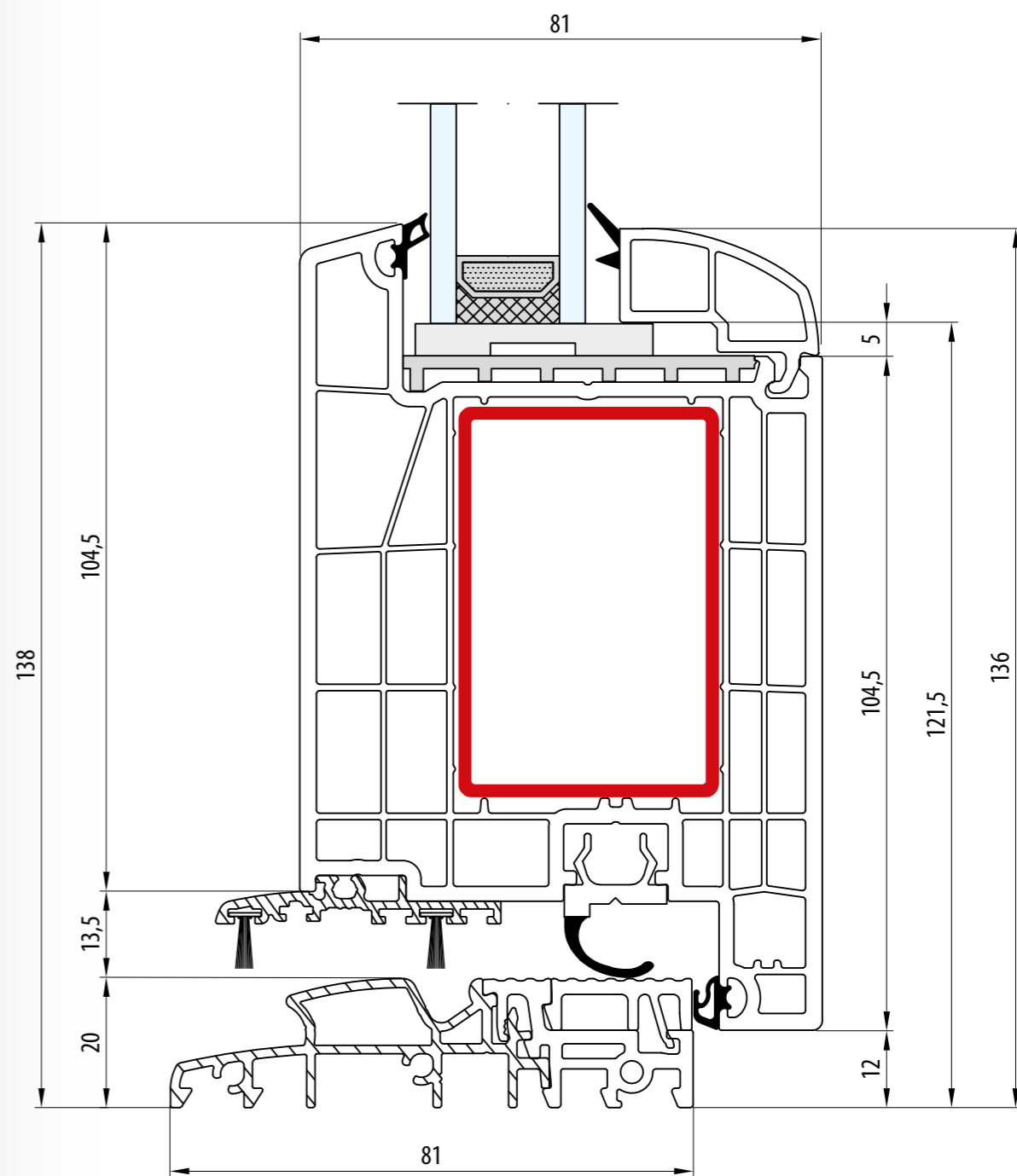
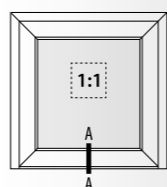

- Próg: 20 mm · Skrzydło: 125 mm
- Seuil: 20 mm · Vantail: 125 mm
- Threshold: 20 mm · Sash: 125 mm
- Schwelle: 20 mm · Flügel: 125 mm
- Soglia: 20 mm · Anta: 125 mm

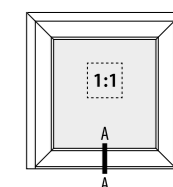

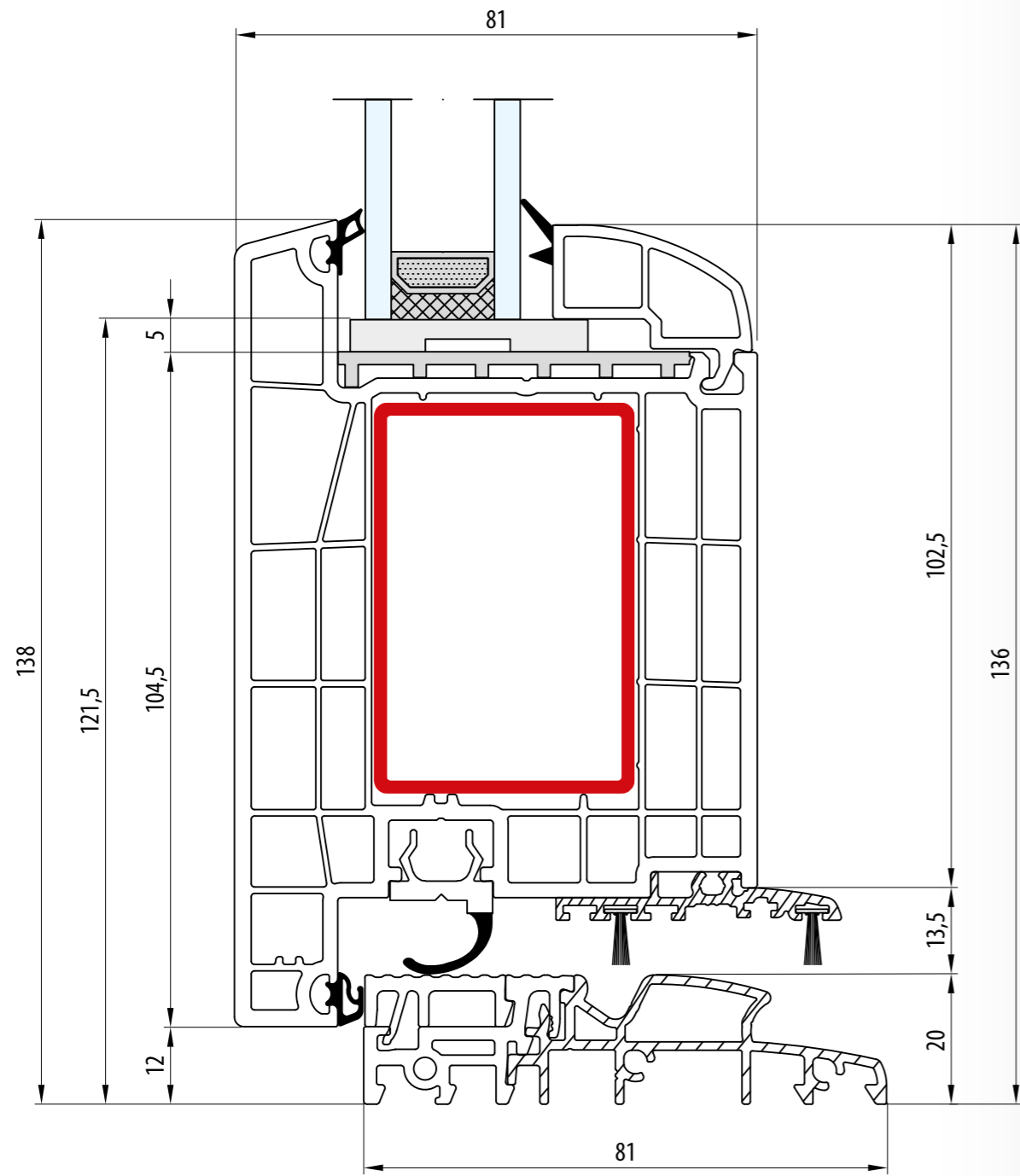

- Próg: 20 mm · Skrzydło: 125 mm
- Seuil: 20 mm · Vantail: 125 mm
- Threshold: 20 mm · Sash: 125 mm
- Schwelle: 20 mm · Flügel: 125 mm
- Soglia: 20 mm · Anta: 125 mm

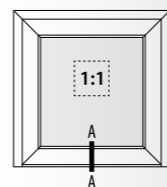

EKOSUN 7

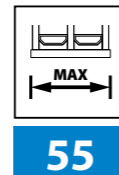
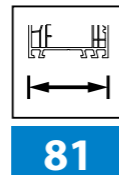
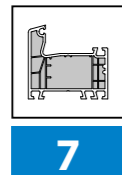

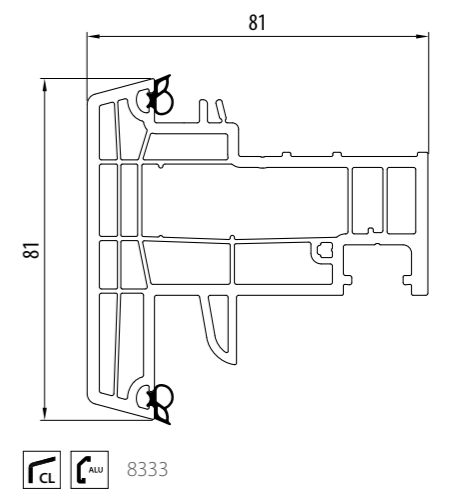
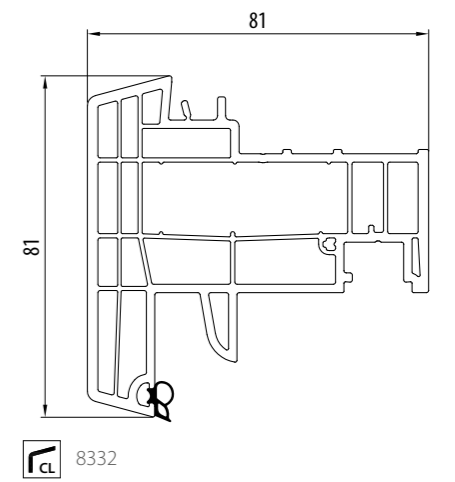
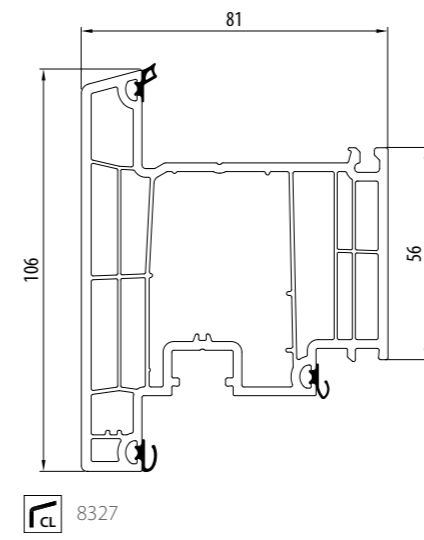
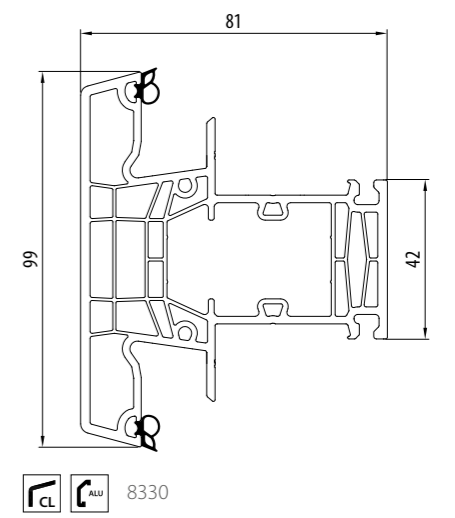
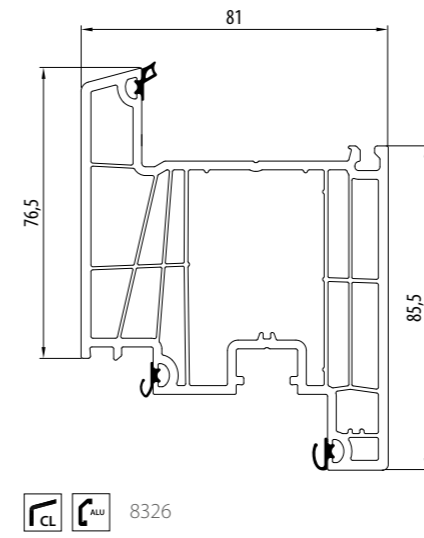
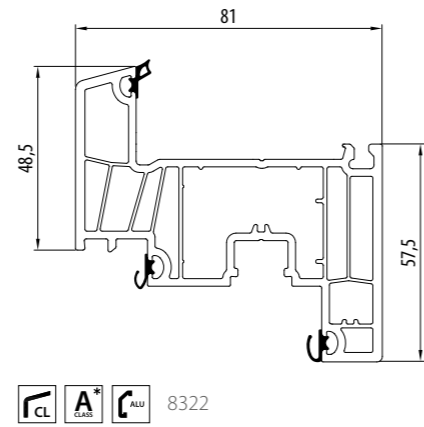
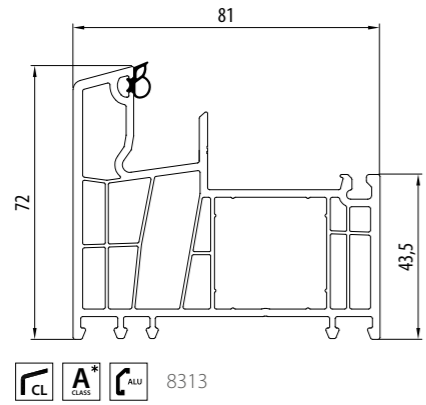
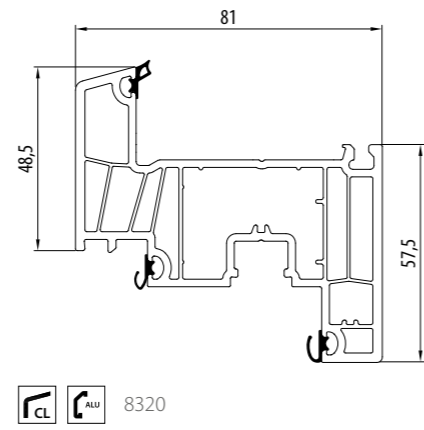
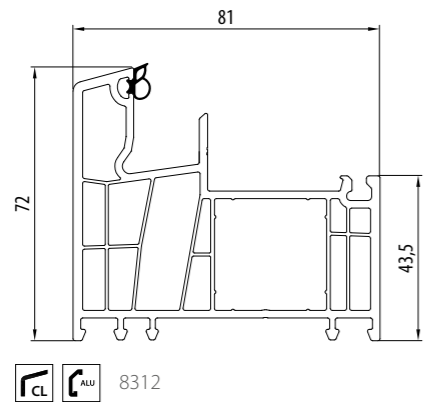

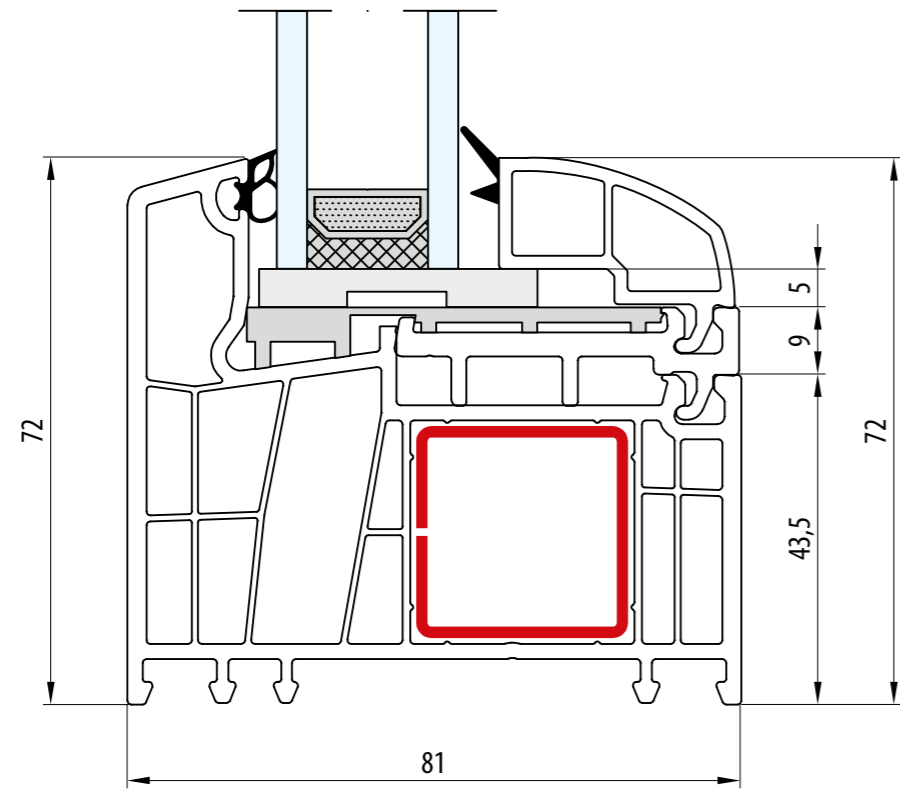

- Rama: 72 mm
- Dormant: 72 mm
- Frame: 72 mm
- Rahmen: 72 mm
- Telaio: 72 mm

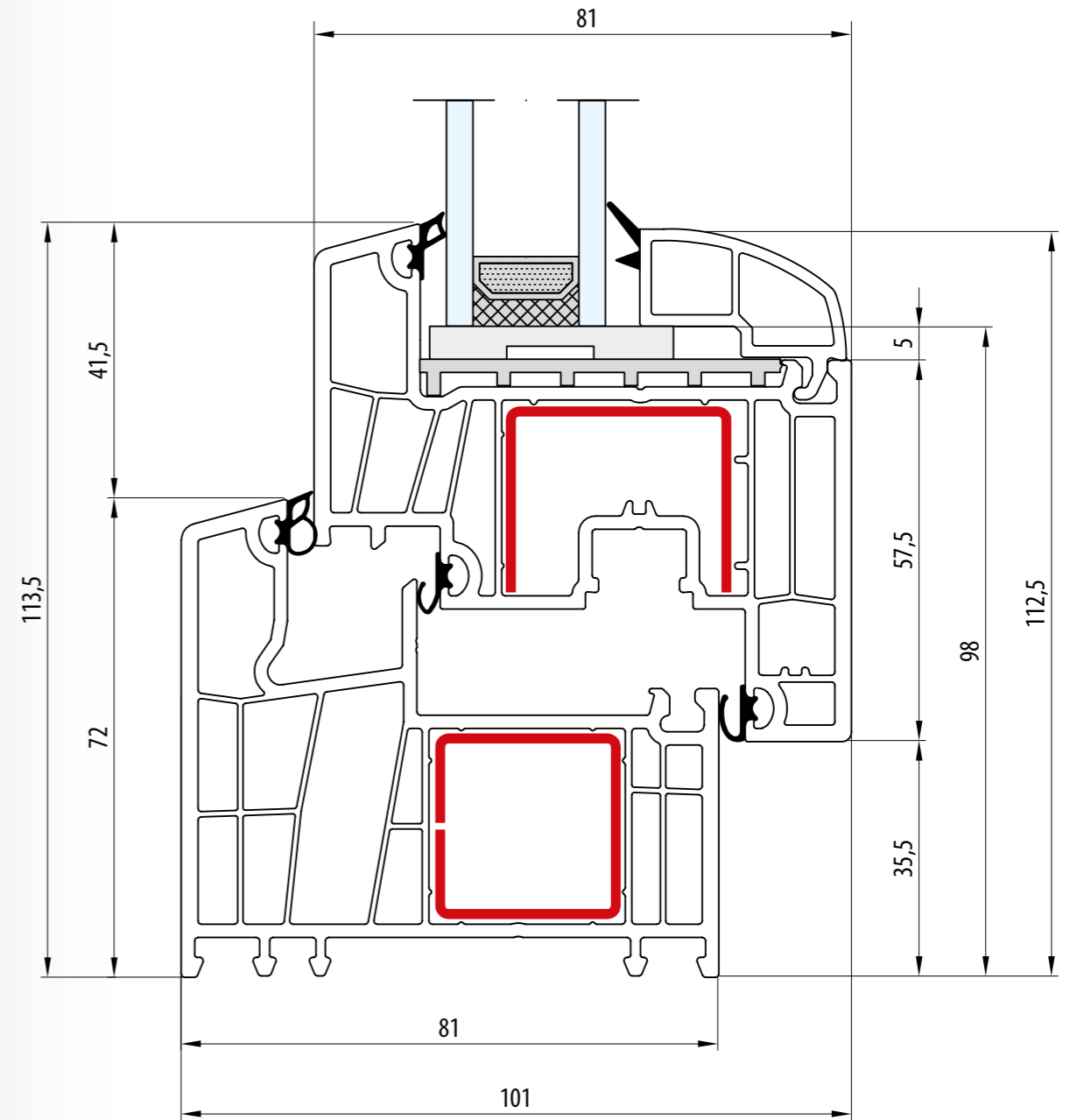
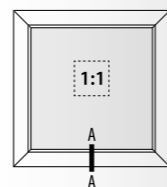

- Rama: 72 mm · Skrzydło: 77 mm
- Dormant: 72 mm · Vantail: 77 mm
- Frame: 72 mm · Sash: 77 mm
- Rahmen: 72 mm · Flügel: 77 mm
- Telaio: 72 mm · Anta: 77 mm

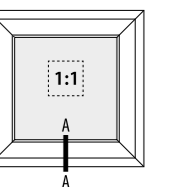

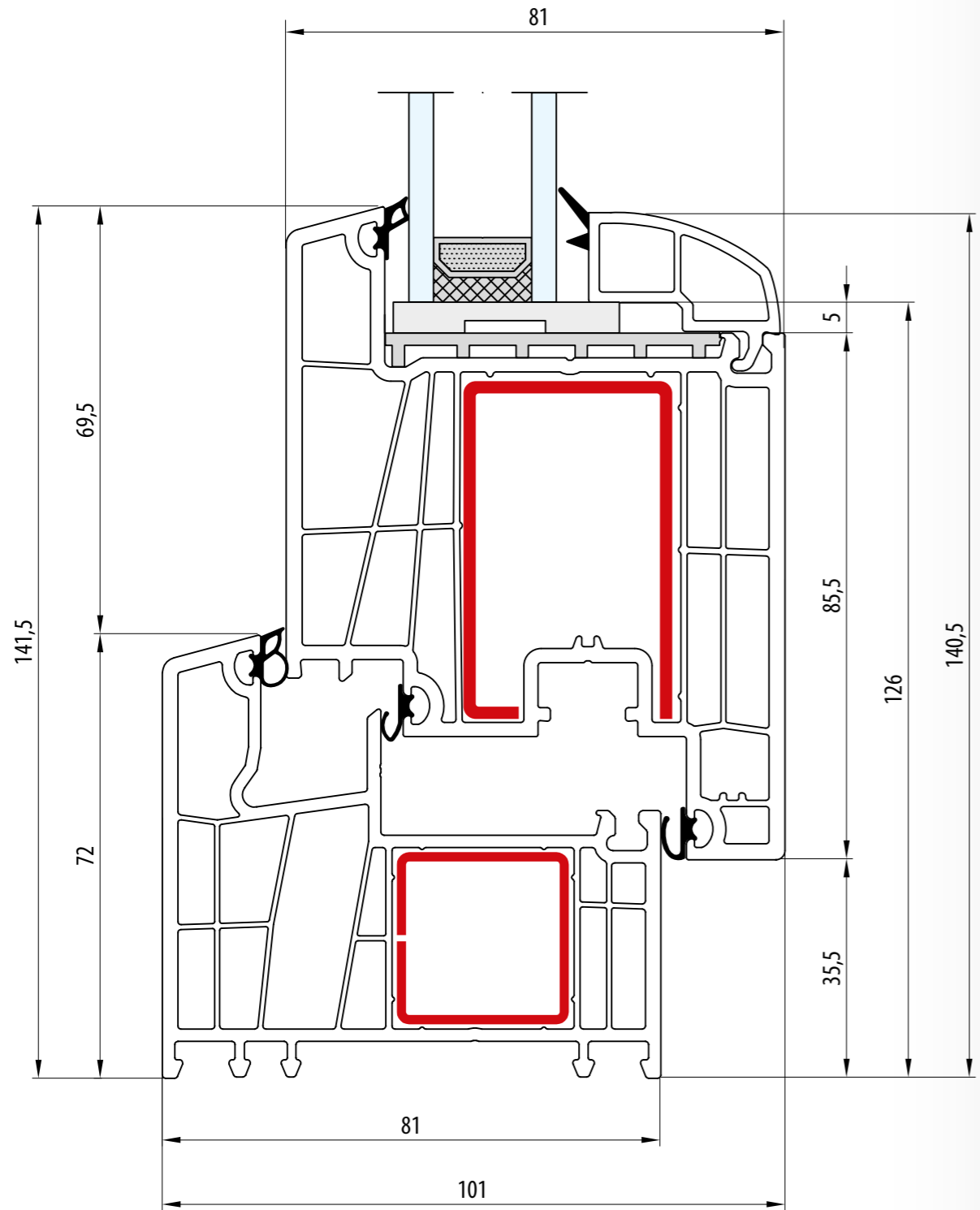

- Rama: 72 mm · Skrzydło: 106 mm
- Dormant: 72 mm · Vantail: 106 mm
- Frame: 72 mm · Sash: 106 mm
- Rahmen: 72 mm · Flügel: 106 mm
- Telaio: 72 mm · Anta: 106 mm

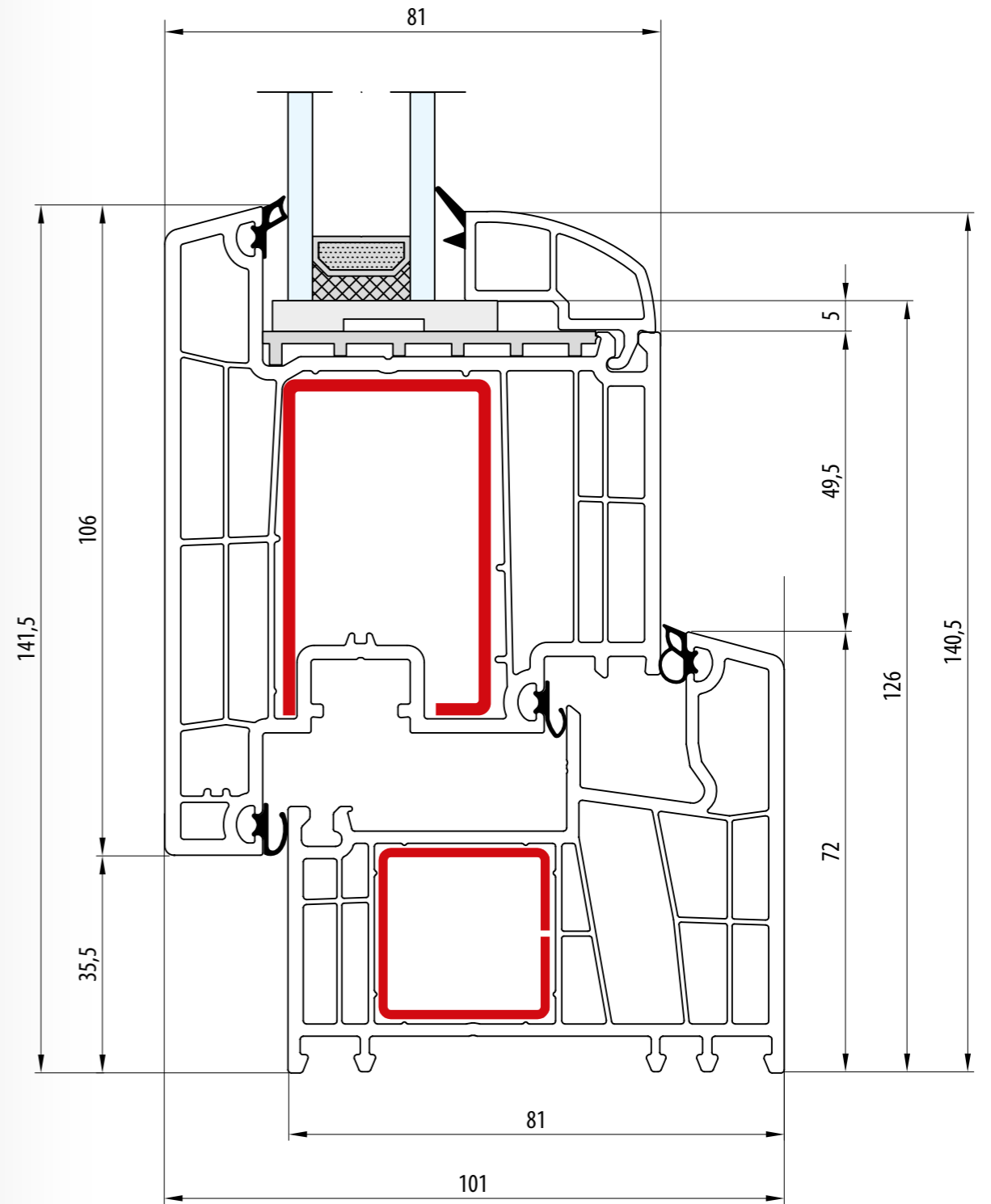
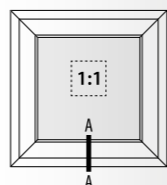

- Rama: 72 mm · Skrzydło: 106 mm
- Dormant: 72 mm · Vantail: 106 mm
- Frame: 72 mm · Sash: 106 mm
- Rahmen: 72 mm · Flügel: 106 mm
- Telaio: 72 mm · Anta: 106 mm

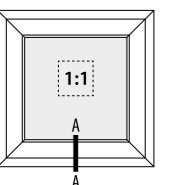

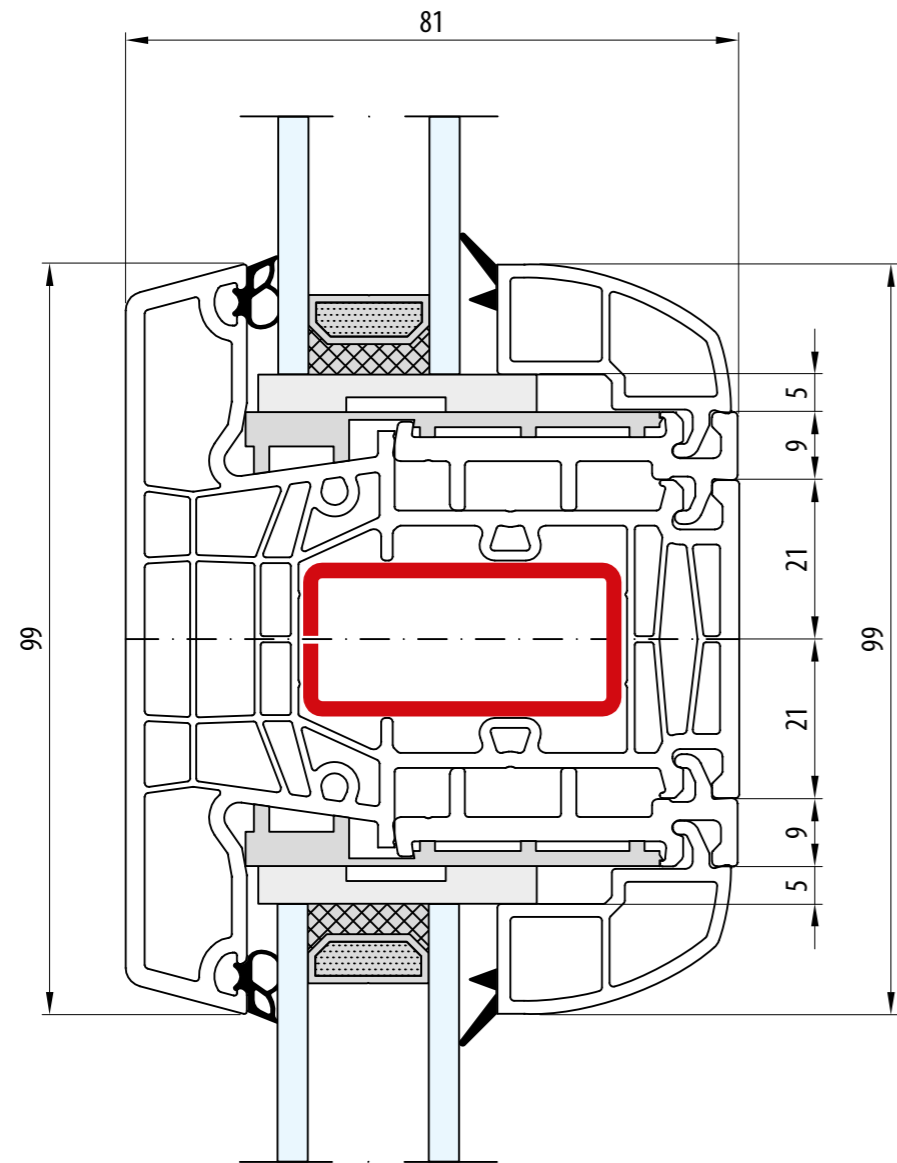

- Słupek stalowy: 99 mm
- Meneau fixe: 99 mm
- Fix post: 99 mm
- Festem Pfahl: 99 mm
- Montante fisso: 99 mm

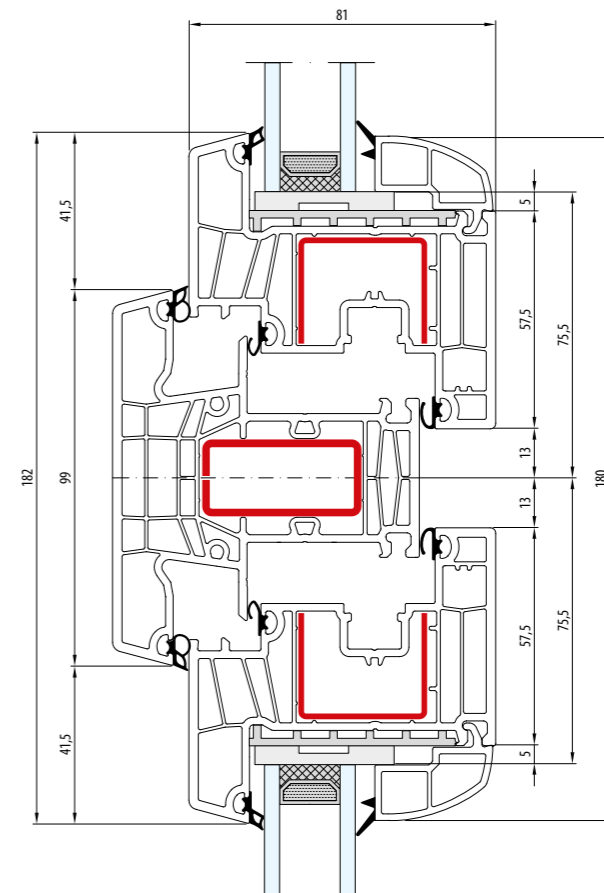
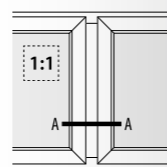

- Słupek stalowy: 99 mm · Skrzydło: 77 mm
- Meneau fixe: 99 mm · Vantail: 77 mm
- Fix post: 99 mm · Sash: 77 mm
- Festem Pfahl: 99 mm · Flügel: 77 mm
- Montante fisso: 99 mm · Anta: 77 mm

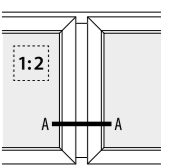

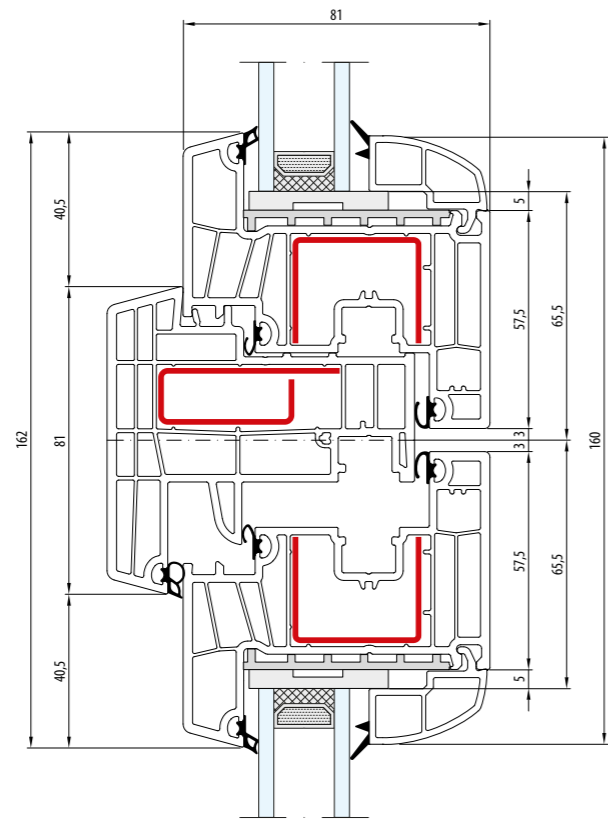

- Słupek ruchomy: 81 mm · Skrzydło: 77 mm
- Meneau mobile: 81 mm · Vantail: 77 mm
- Movable post: 81 mm · Sash: 77 mm
- Stulp: 81 mm · Flügel: 77 mm
- Montante mobile: 81 mm · Anta: 77 mm

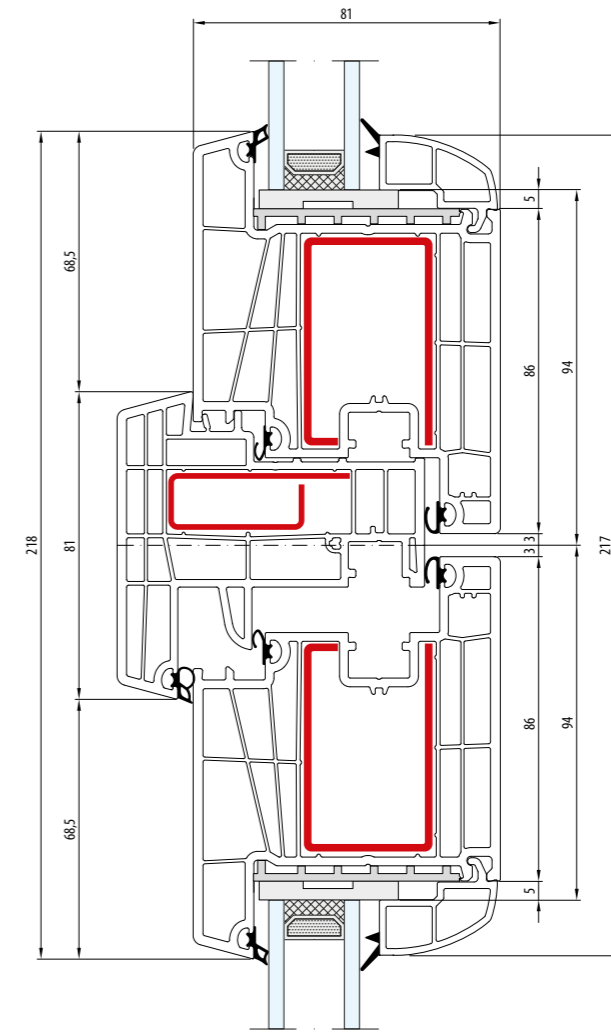
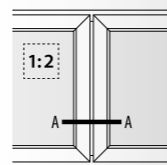

- Słupek ruchomy: 81 mm · Skrzydło: 106 mm
- Meneau mobile: 81 mm · Vantail: 106 mm
- Movable post: 81 mm · Sash: 106 mm
- Stulp: 81 mm · Flügel: 106 mm
- Montante mobile: 81 mm · Anta: 106 mm

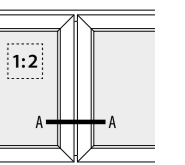

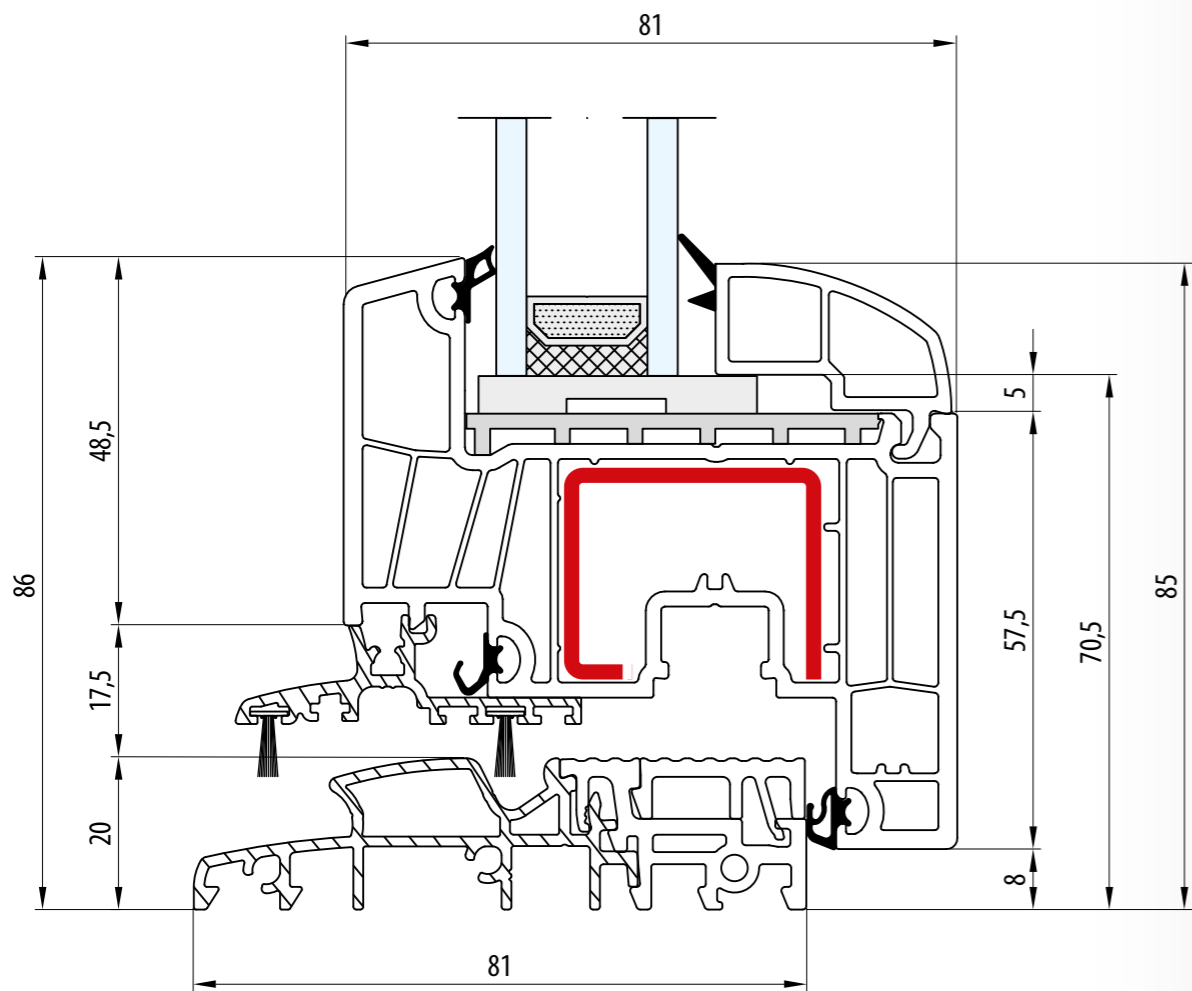

- Próg: 20 mm · Skrzydło: 77 mm
- Seuil: 20 mm · Vantail: 77 mm
- Threshold: 20 mm · Sash: 77 mm
- Schwelle: 20 mm · Flügel: 77 mm
- Soglia: 20 mm · Anta: 77 mm

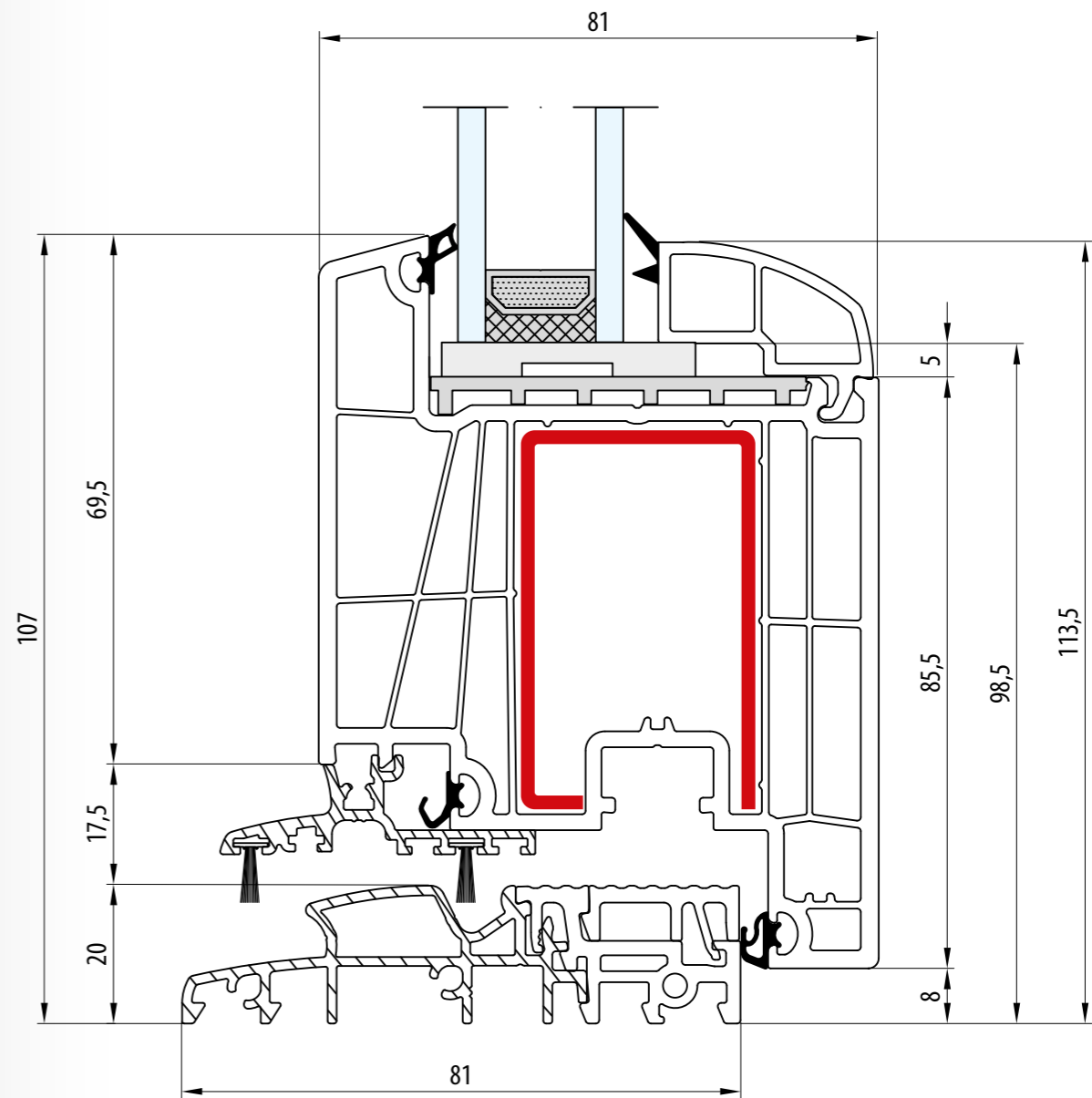
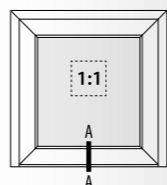

- Próg: 20 mm · Skrzydło: 106 mm
- Seuil: 20 mm · Vantail: 106 mm
- Threshold: 20 mm · Sash: 106 mm
- Schwelle: 20 mm · Flügel: 106 mm
- Soglia: 20 mm · Anta: 106 mm

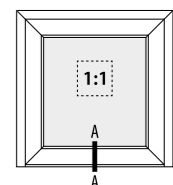

HST EKOSUN

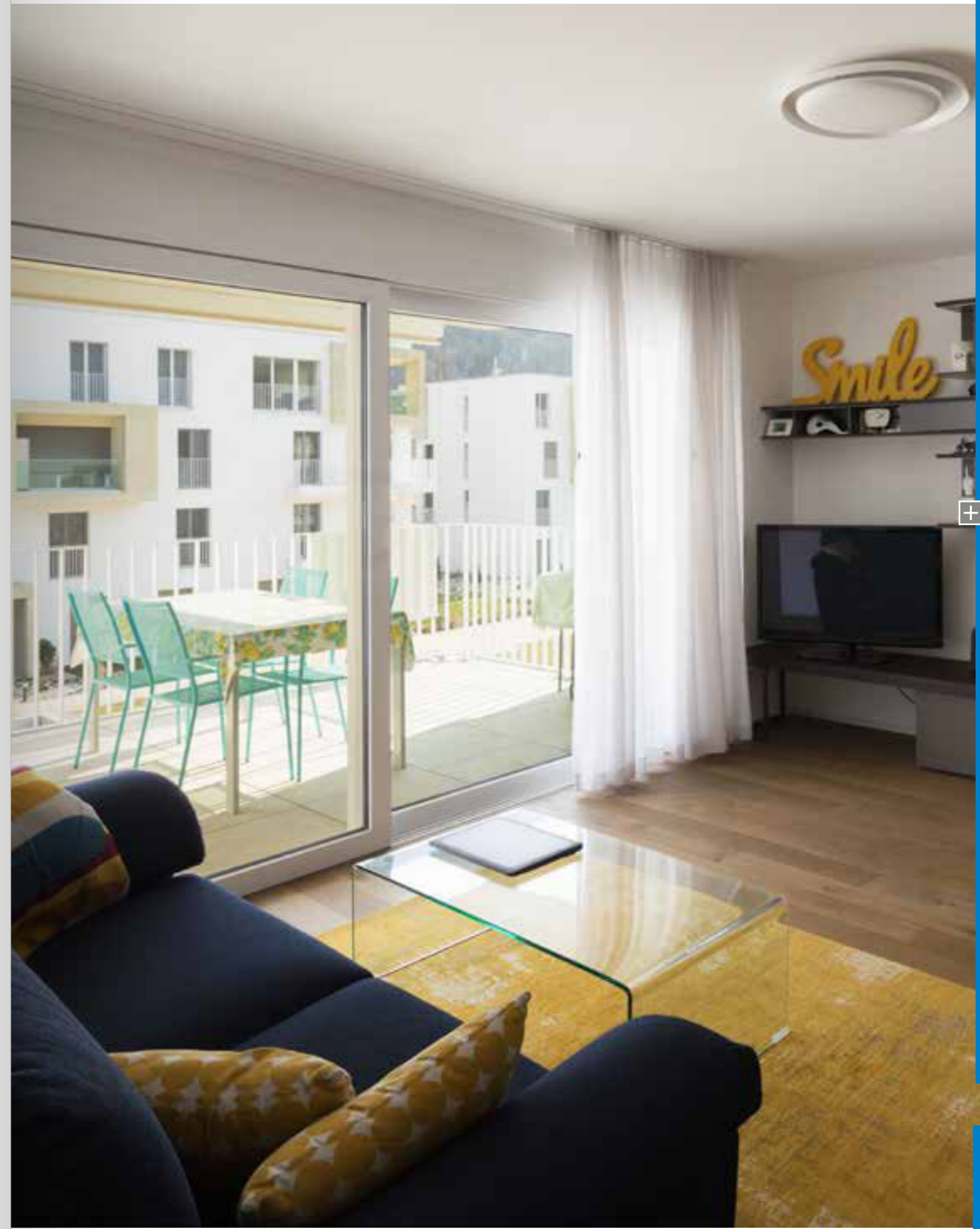
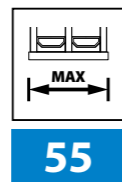
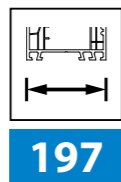
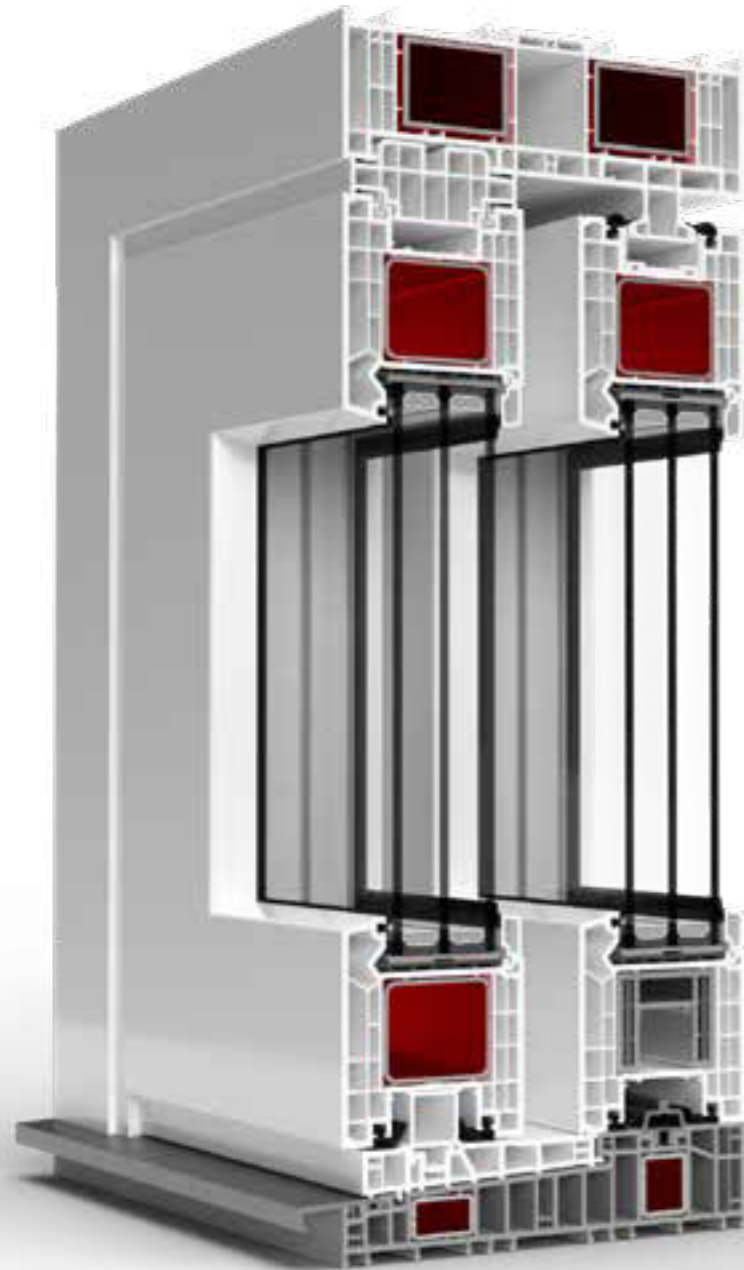

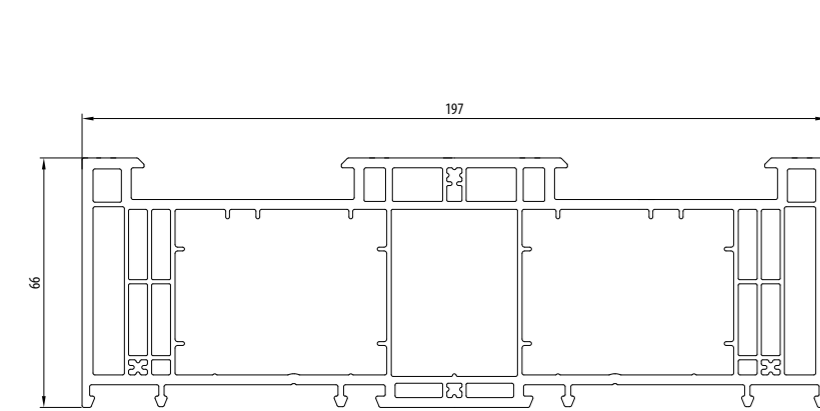

8510

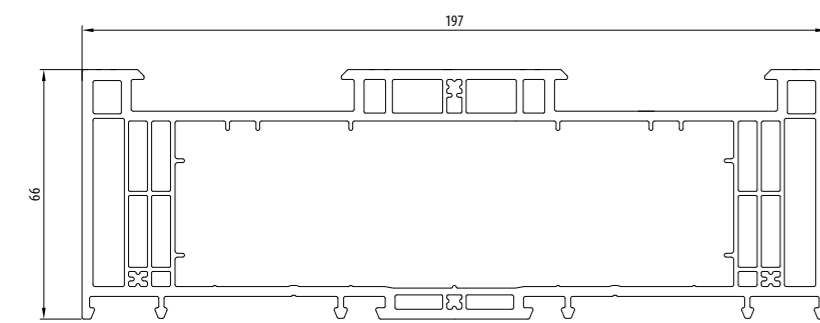

8511

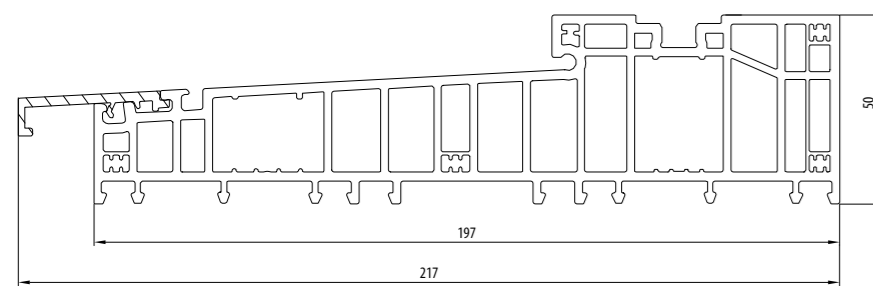

Inspiro

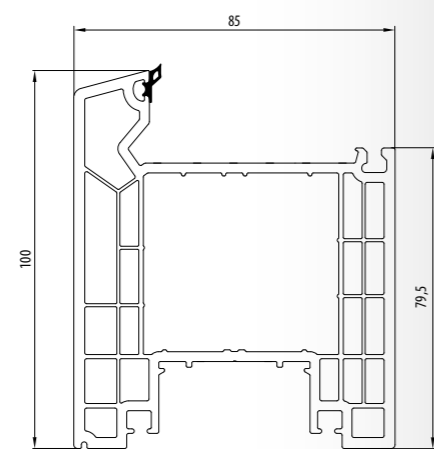

8520

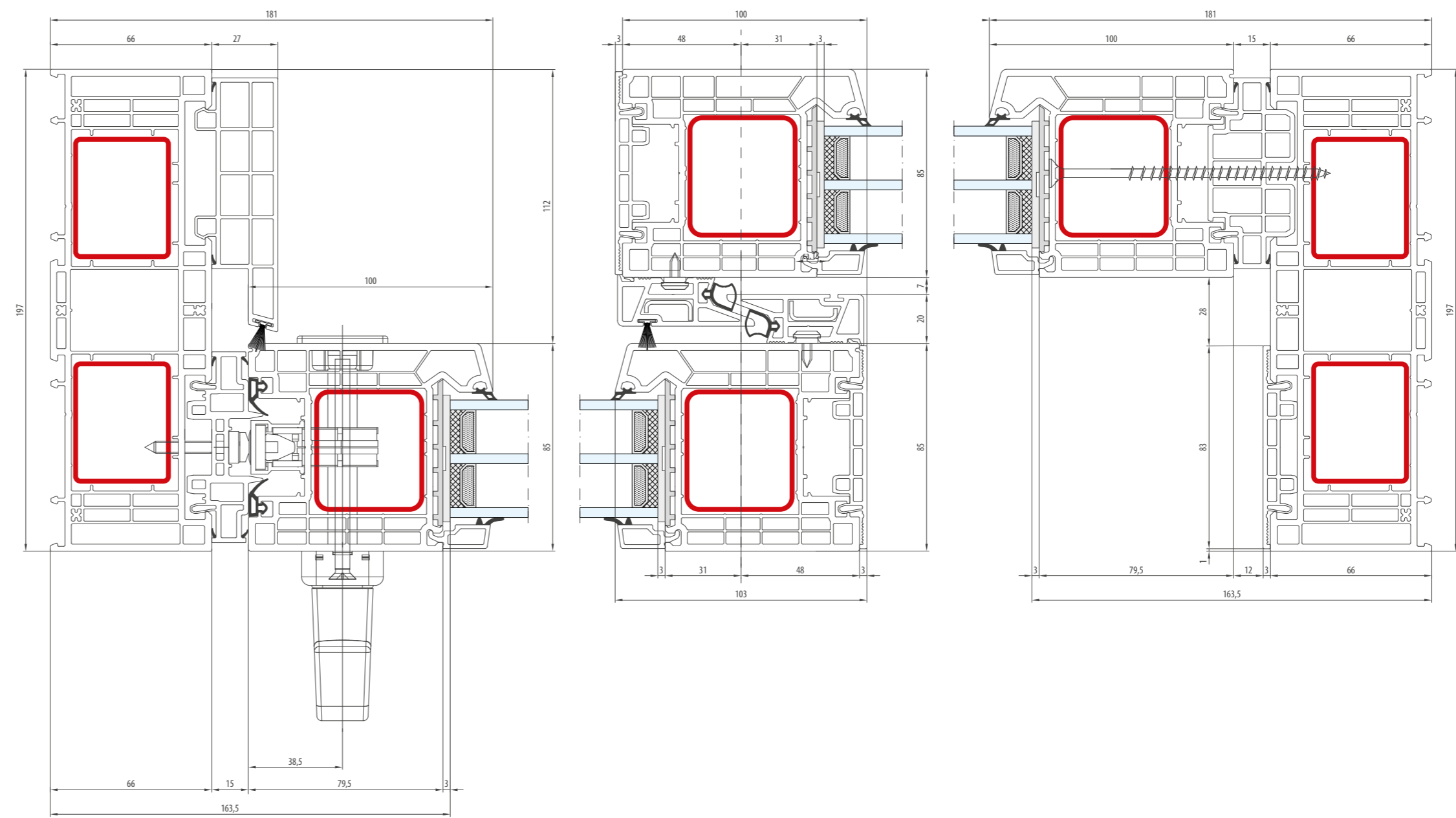

- Schemat A - Przekrój poziomy · Rama: 66 mm · Skrzydło: 100 mm
- Schéma A - Coupe horizontale · Dormant: 66 mm · Vantail: 100 mm
- Schema A - Doorsnede horizontaal · Frame: 66 mm · Sash: 100 mm
- Schema A - Wagerechter Schnitt · Rahmen: 66 mm · Flügel: 100 mm
- Schema A - Sezione orizzontale · Telaio: 66 mm · Anta: 100 mm

1:2

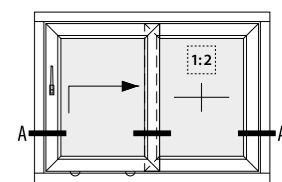

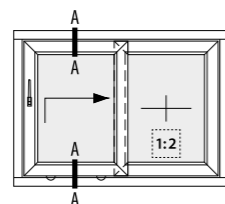
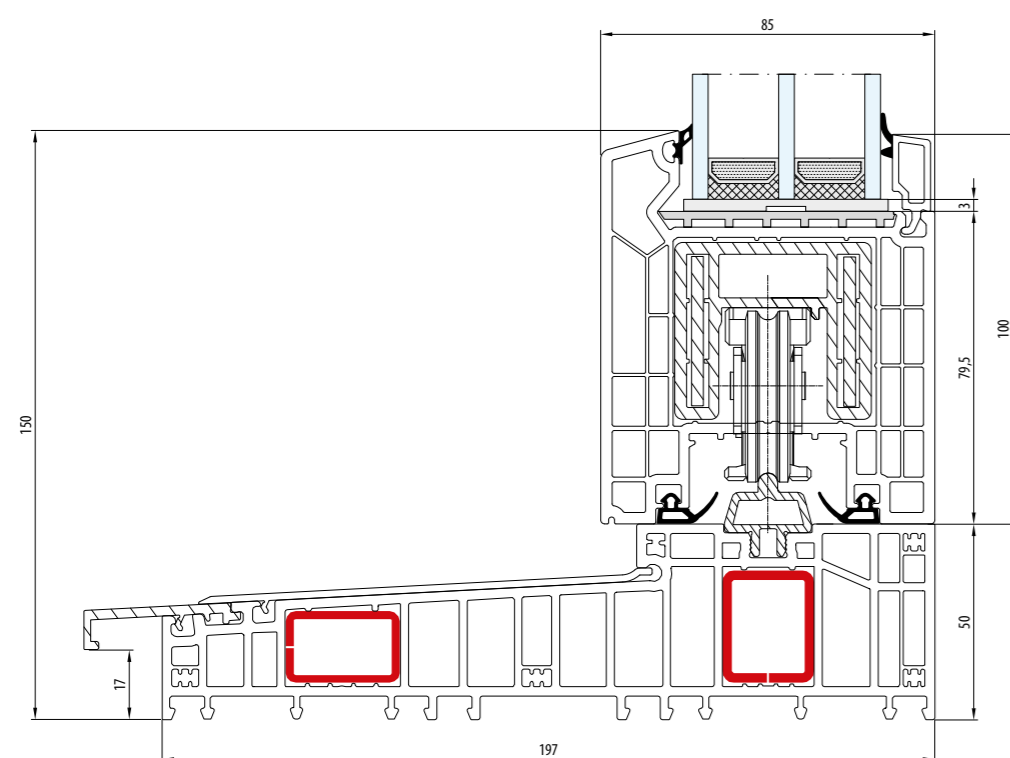
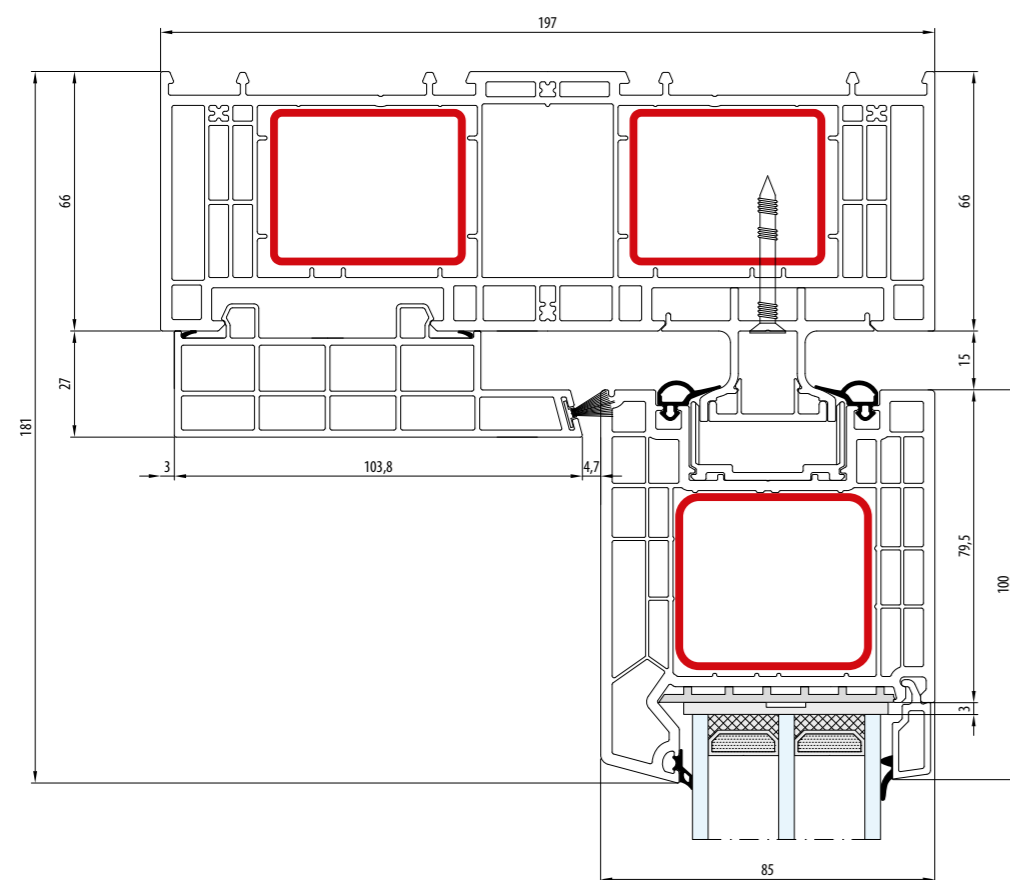

- Schemat A - Przekrój pionowy · Próg: 50 mm · Skrzydło: 100 mm
- Schéma A - Coupe verticale · Seuil: 50 mm · Vantail: 100 mm
- Schema A - Doorsnede verticaal · Doorstep: 50 mm · Sash: 100 mm
- Schema A - Senkrechter Schnitt · Schwelle: 50 mm · Flügel: 100 mm
- Schema A - Sezione verticale · Soglia: 50 mm · Anta: 100 mm

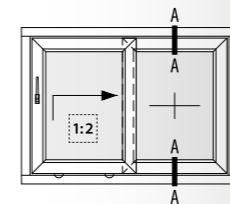
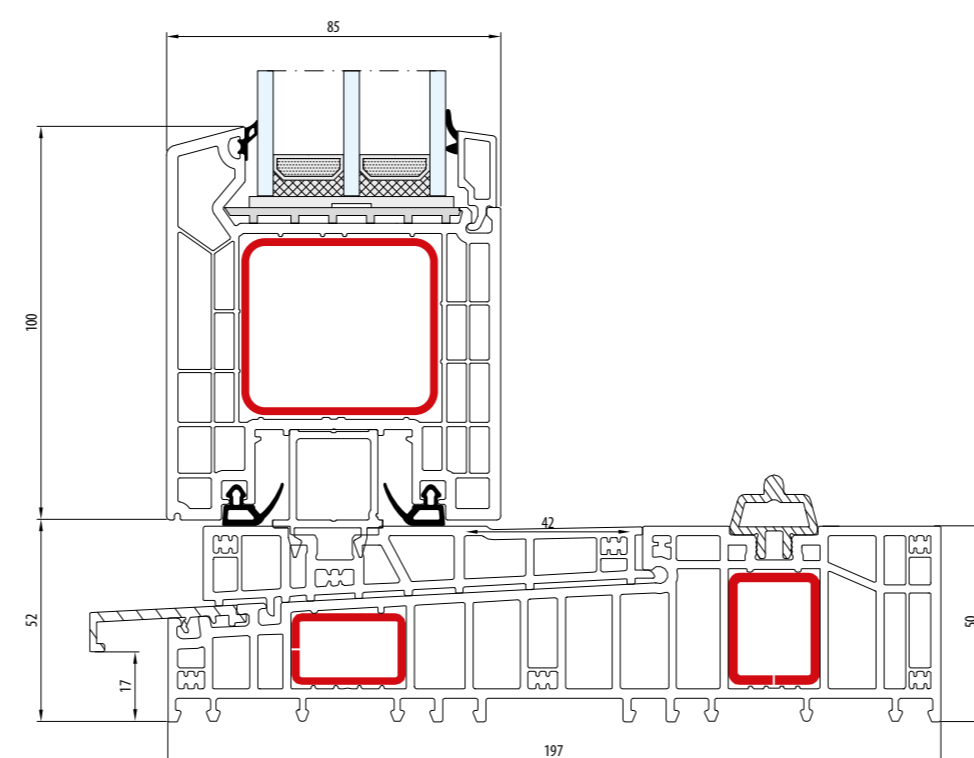
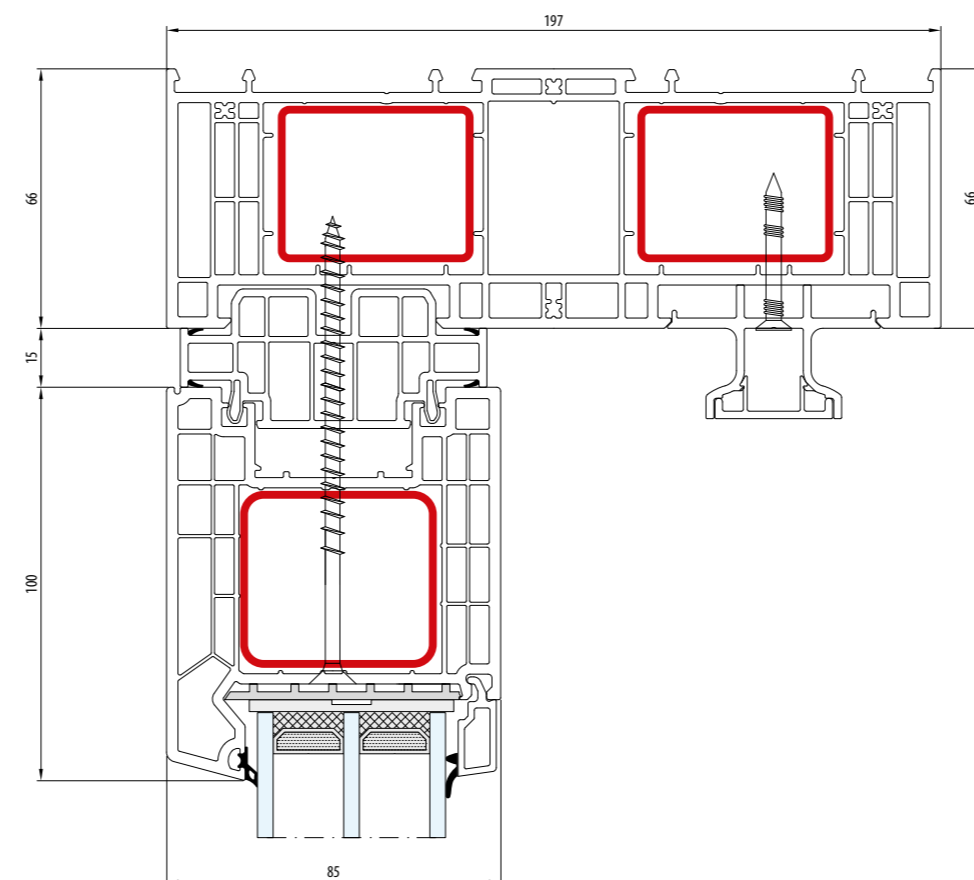

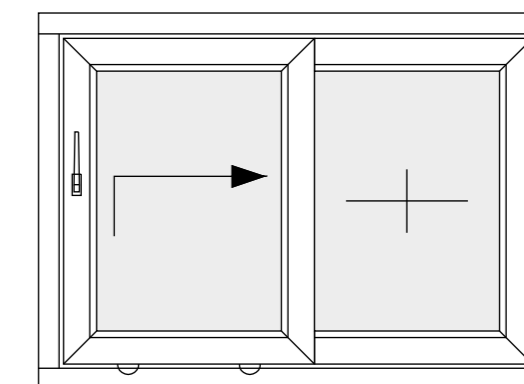

- Schemat A - Przekrój pionowy · Próg: 50 mm · Skrzydło: 100 mm
- Schéma A - Coupe verticale · Seuil: 50 mm · Vantail: 100 mm
- Schema A - Doorsnede verticaal · Doorstep: 50 mm · Sash: 100 mm
- Schema A - Senkrechter Schnitt · Schwelle: 50 mm · Flügel: 100 mm
- Schema A - Sezione verticale · Soglia: 50 mm · Anta: 100 mm

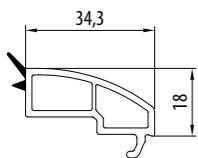
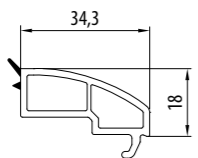
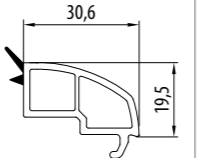
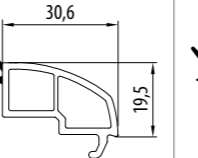
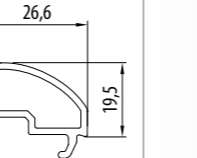
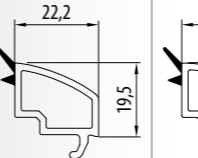
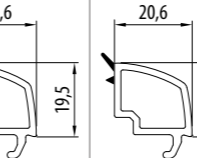
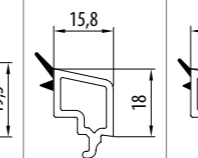
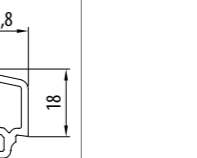
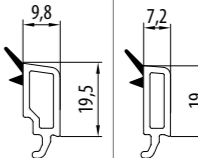
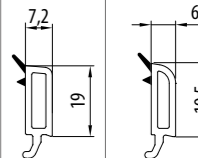

A

- Schemat
- Schéma
- Schema
- Schema
- Schema

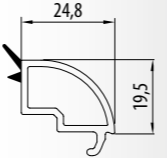
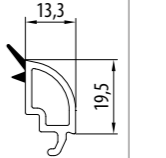
d [mm]							d [mm]										
EkoSun 70						23 - 24 - 25	26 - 27			32 - 33		35 - 36 - 37	38 - 39 - 40	41	42 - 43	44 - 45	
EkoSun 6 EkoSun 7 EkoSun HST	23 - 24	25 - 26	27 - 28	29 - 30	31 - 32	33 - 34	35 - 36	37 - 38	39 - 40	41 - 42	43 - 44	45 - 46	47 - 48	49 - 50	51 - 52	53 - 54 - 55	
																	
	6145	6245	7146	7246	7148		7149	7147	7247	6140	6240		7145	6143	6243	7244	
																	
						7140						7143					

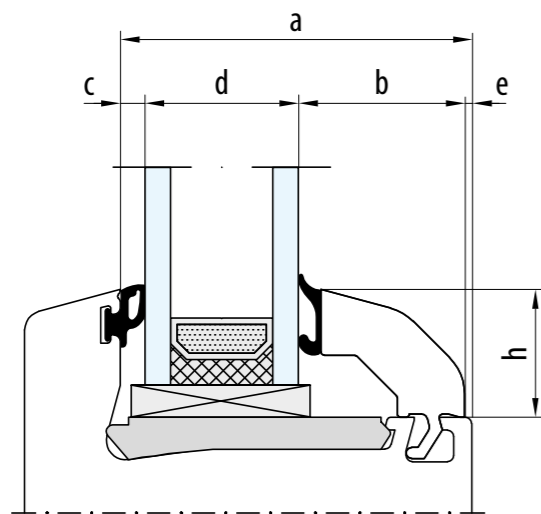

$$b = a - c - d - e$$

	a [mm]	c [mm]	e [mm]
EkoSun 70	56	4	1
EkoSun 6 EkoSun 7 EkoSun HST	65	4	1

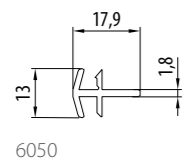

6050

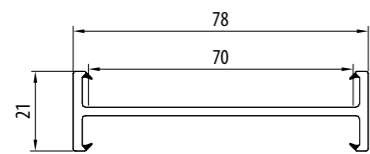

7050

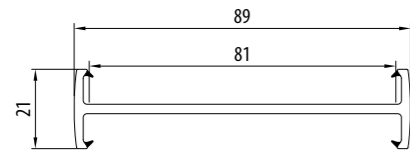

8150

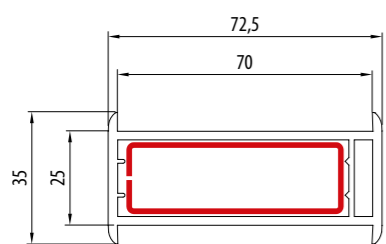

7153

1,5 | 90-227-10 | lx 1,4 | ly 8,7

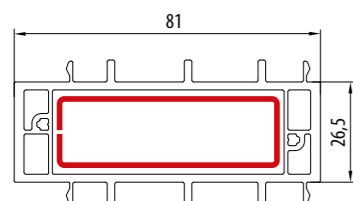

8153

1,5 | 90-227-10 | lx 1,4 | ly 8,7

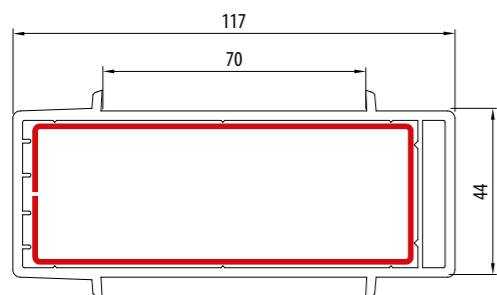

7056

1,5 | 90-230-10 | lx 10,3 | ly 48,5

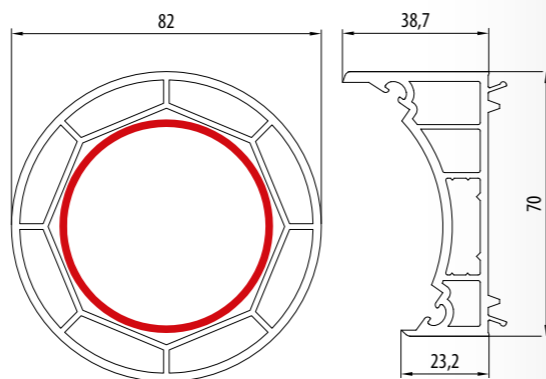

7054

2,0 | 90-228-10 | lx 12,3 | ly 12,3

7055

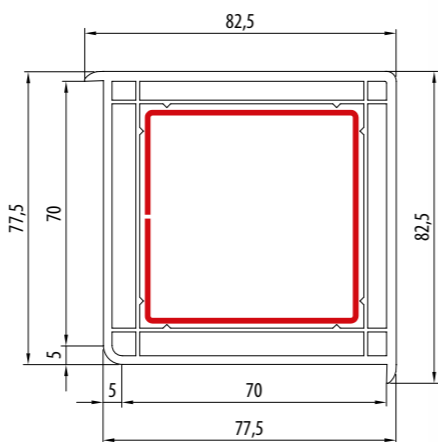

7052

1,5 | 90-225-10 | lx 16,0 | ly 15,8

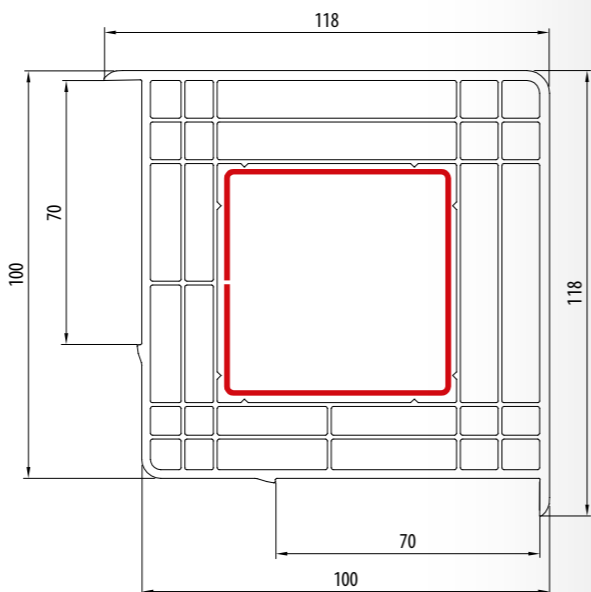

9152

1,5 | 90-225-10 | lx 16,0 | ly 15,8

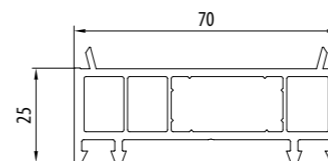

7058

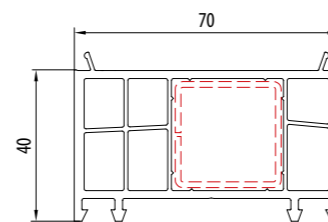

7051

0,0 | - | lx 0,0 | ly 0,0
1,5 | 90-101-10 | lx 1,8 | ly 1,7

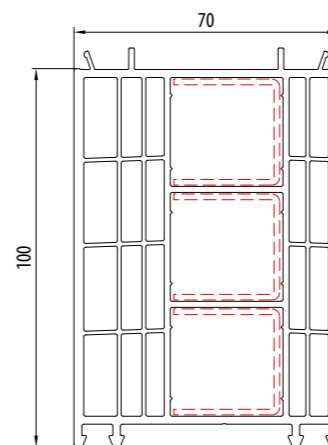

7159

0,0 | - | lx 0,0 | ly 0,0
1,5 | 90-100-10x3 | lx 4,9 | ly 2,9

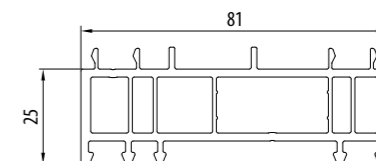

8158

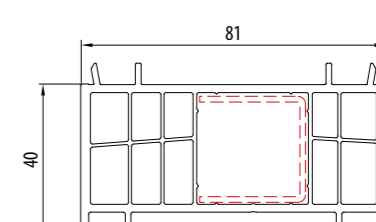

8151

0,0 | - | lx 0,0 | ly 0,0
1,5 | 90-100-10 | lx 1,6 | ly 0,9

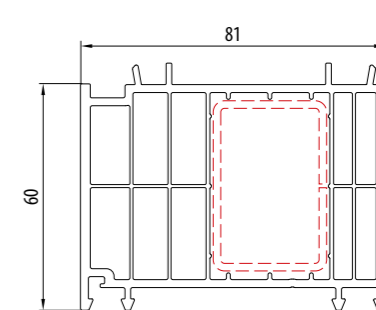

8157

0,0 | - | lx 0,0 | ly 0,0
2,0 | 90-247-10 | lx 7,5 | ly 3,9

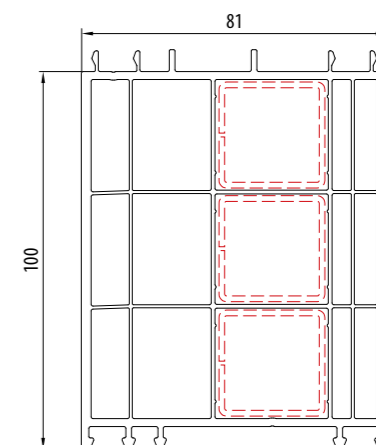

8159

0,0 | - | lx 0,0 | ly 0,0
1,5 | 90-101-10x3 | lx 5,4 | ly 5,3



INNOVATION MIT SYSTEM

S 9000

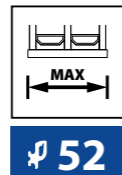
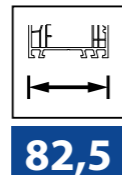
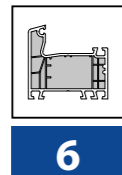

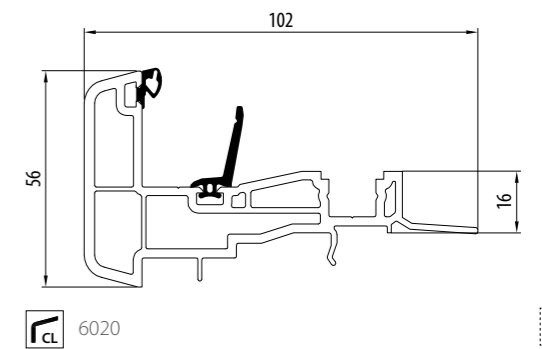
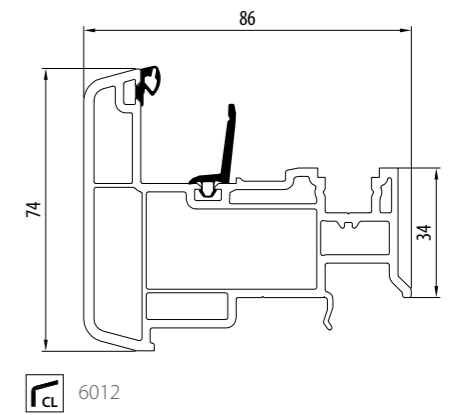
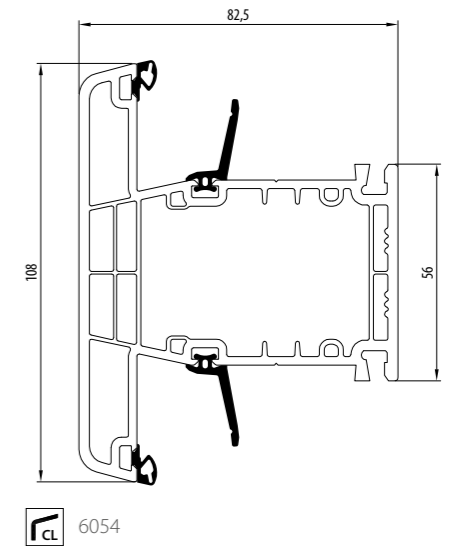
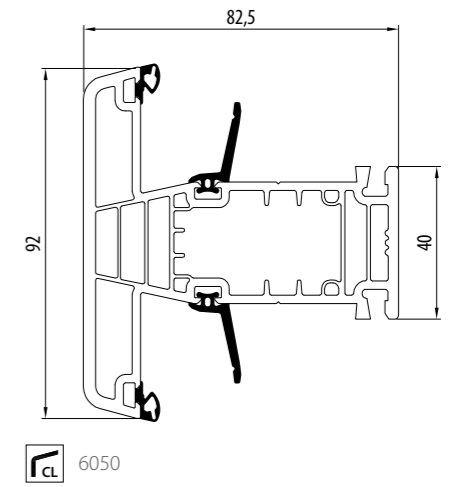
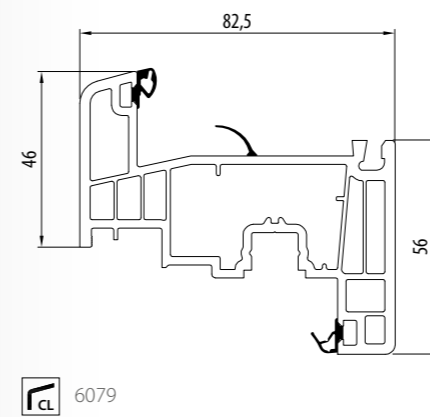
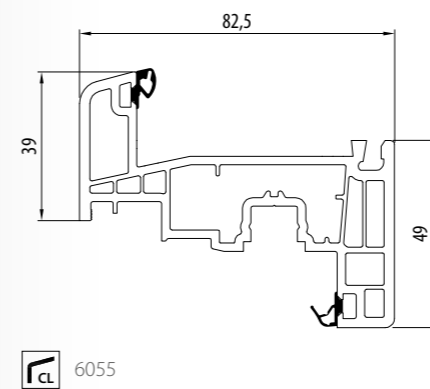
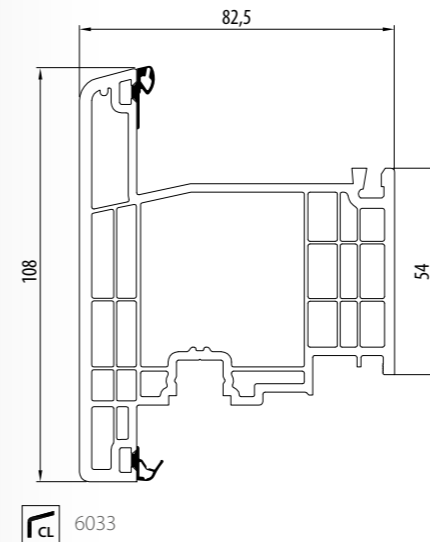
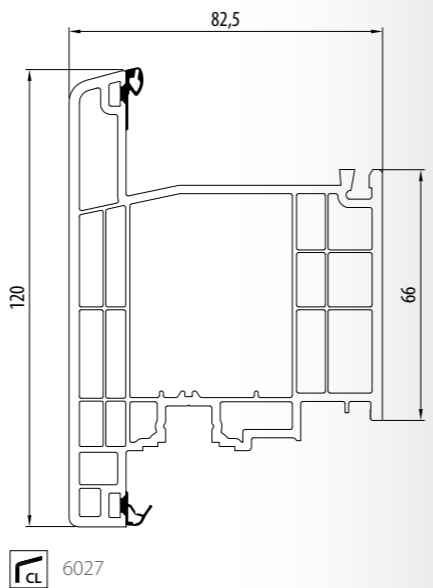
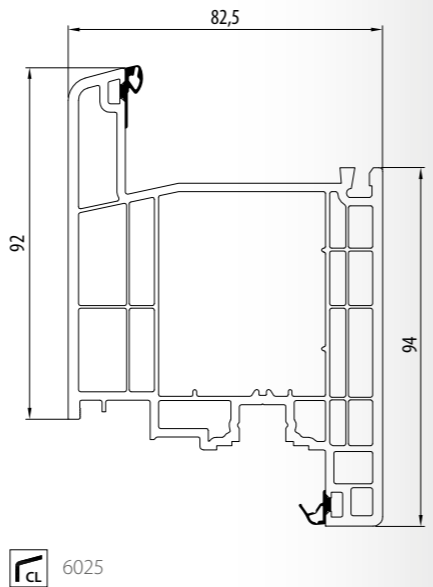
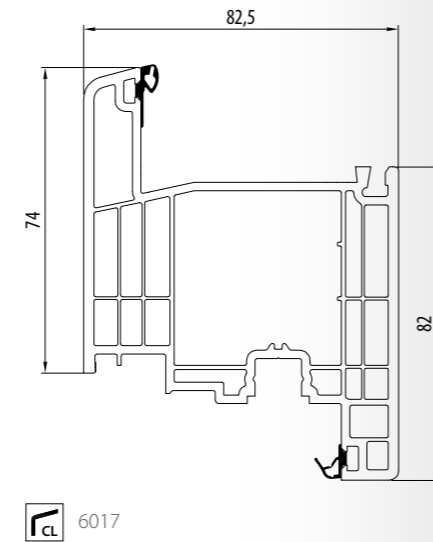
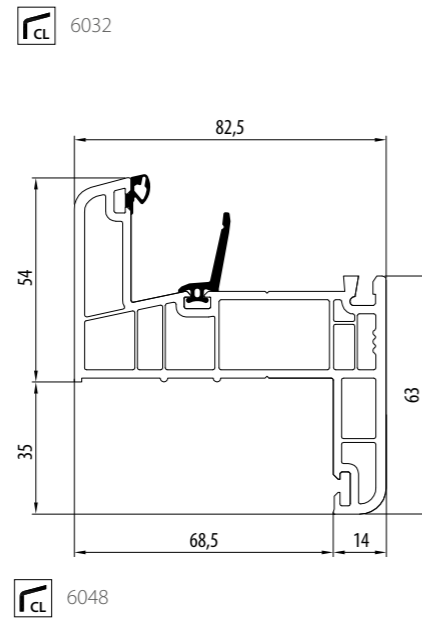
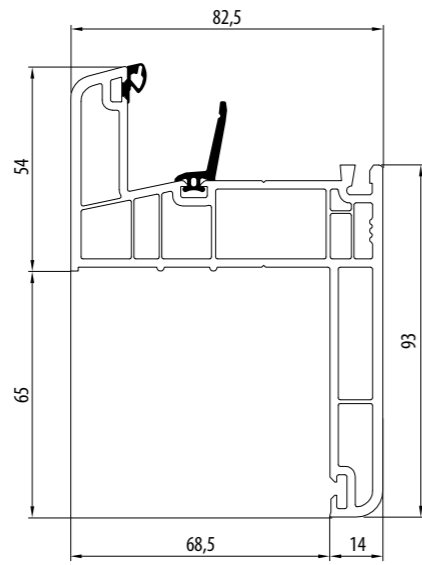
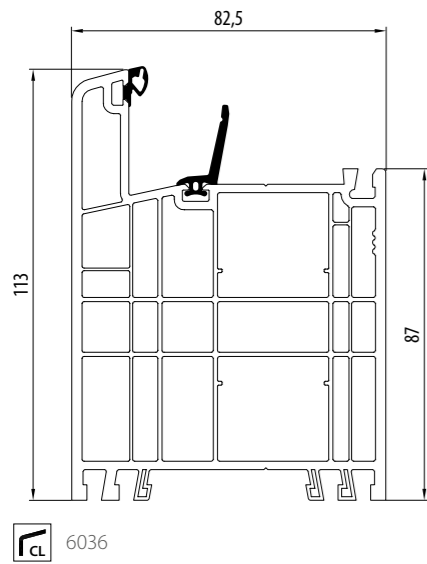
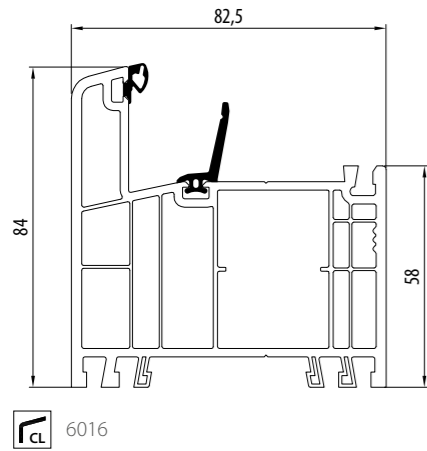
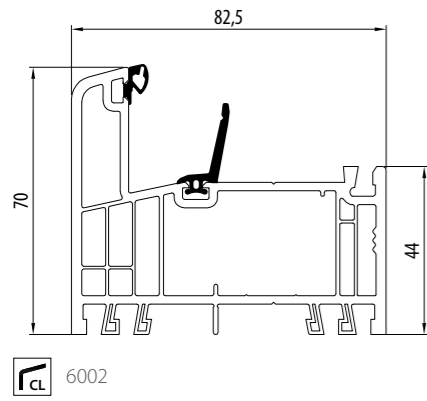

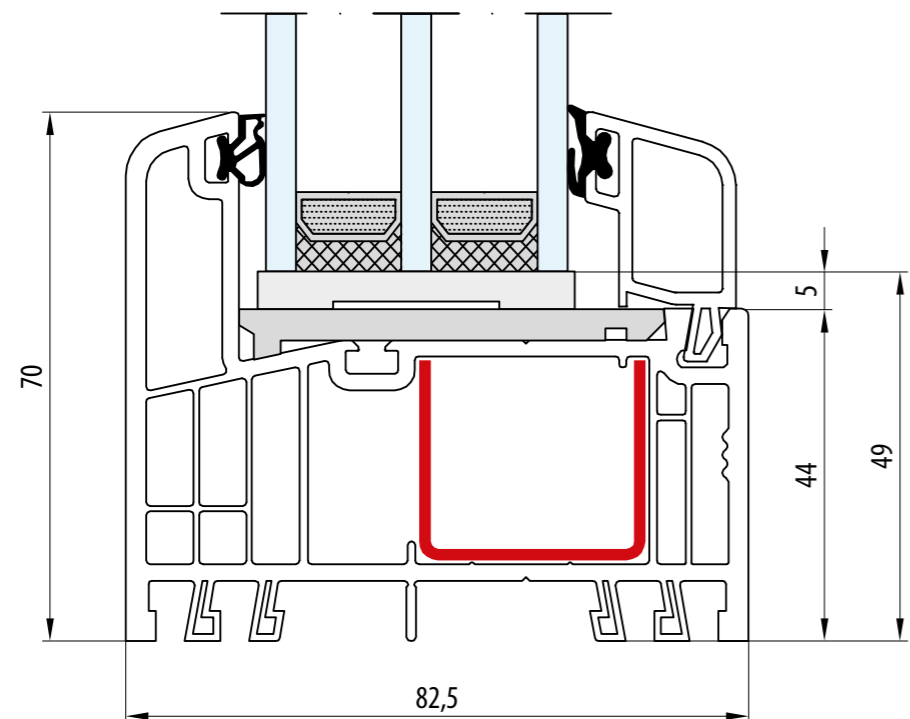

- Rama: 70 mm
- Dormant: 70 mm
- Frame: 70 mm
- Rahmen: 70 mm
- Telaio: 70 mm

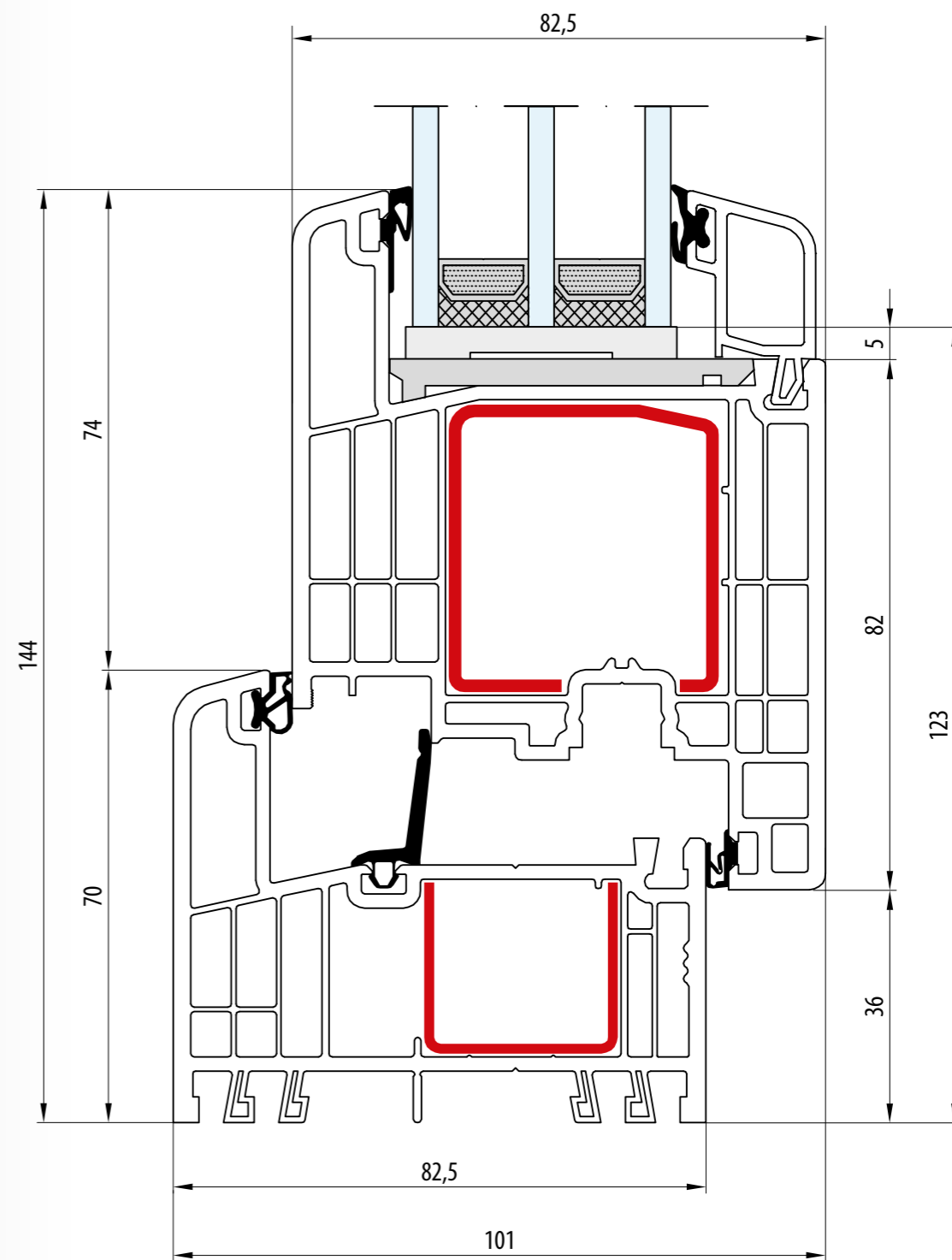
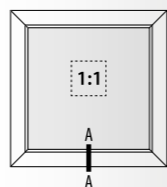

- Rama: 70 mm · Skrzydło: 108 mm
- Dormant: 70 mm · Vantail: 108 mm
- Frame: 70 mm · Sash: 108 mm
- Rahmen: 70 mm · Flügel: 108 mm
- Telaio: 70 mm · Anta: 108 mm

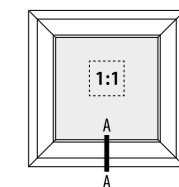

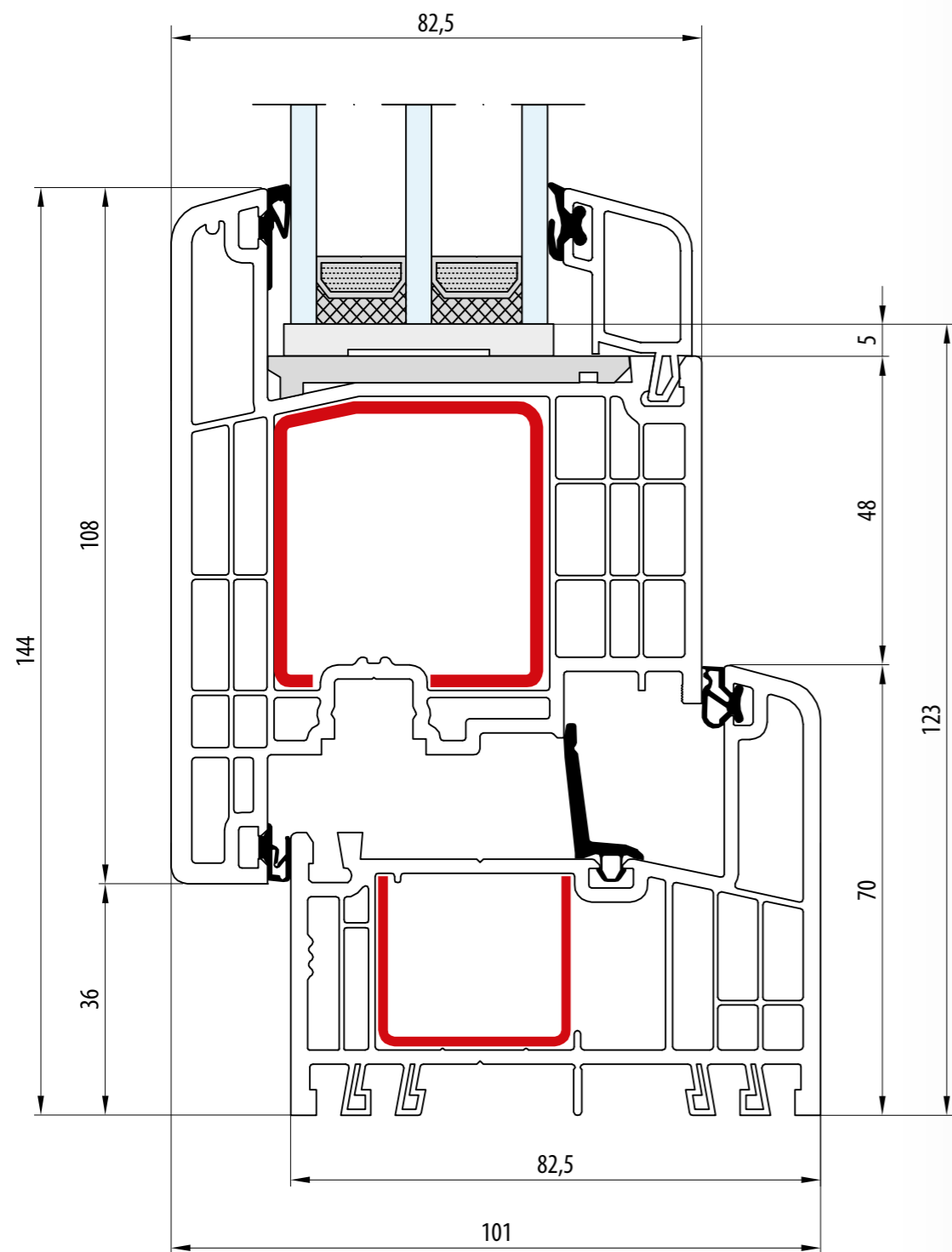

- Rama: 70 mm · Skrzydło: 108 mm
- Dormant: 70 mm · Vantail: 108 mm
- Frame: 70 mm · Sash: 108 mm
- Rahmen: 70 mm · Flügel: 108 mm
- Telaio: 70 mm · Anta: 108 mm

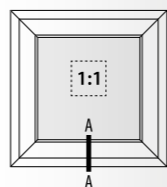

STV

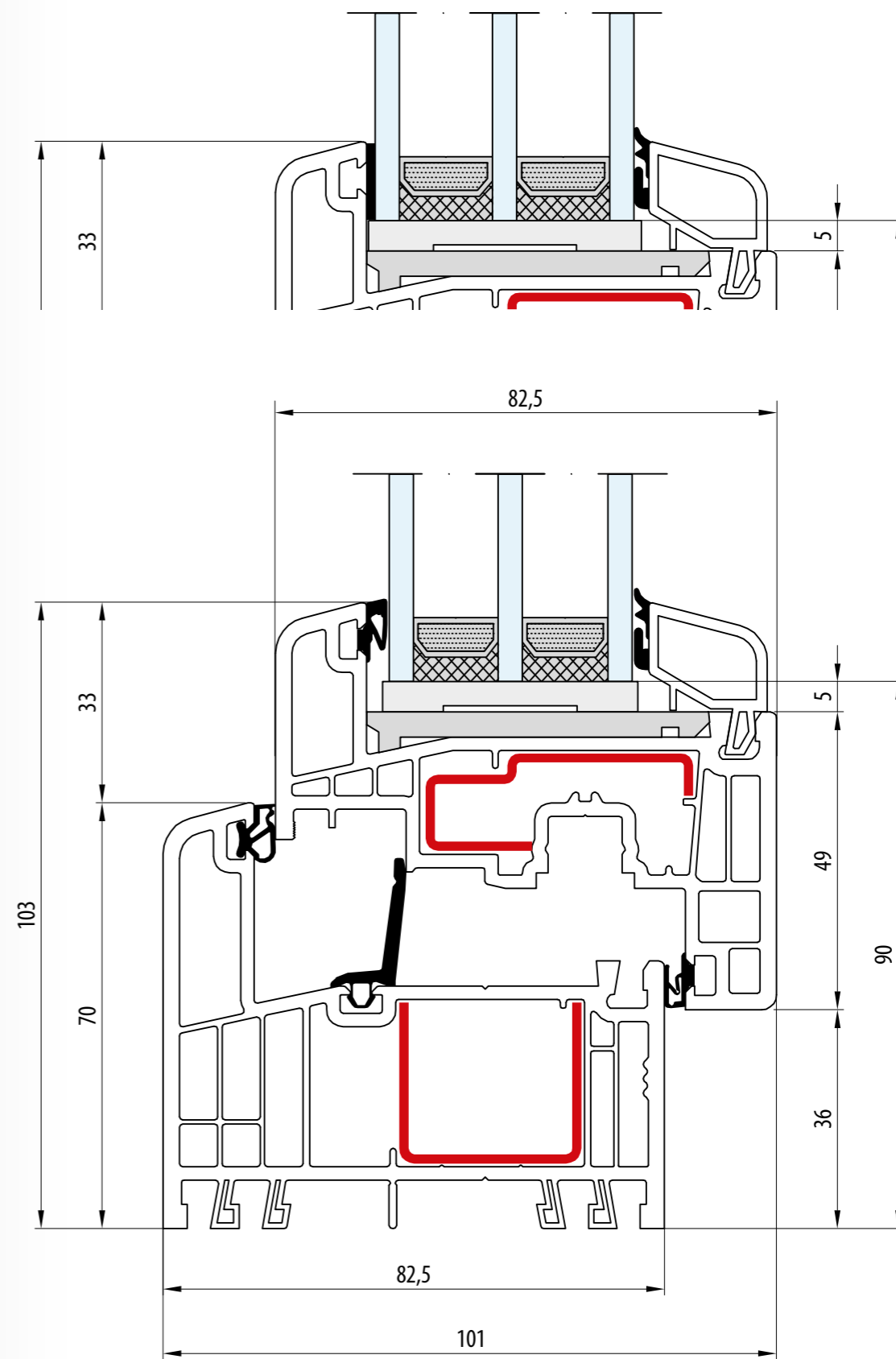

- Rama: 70 mm · Skrzydło: 67 mm
- Dormant: 70 mm · Vantail: 67 mm
- Frame: 70 mm · Sash: 67 mm
- Rahmen: 70 mm · Flügel: 67 mm
- Telaio: 70 mm · Anta: 67 mm

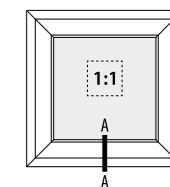



STV

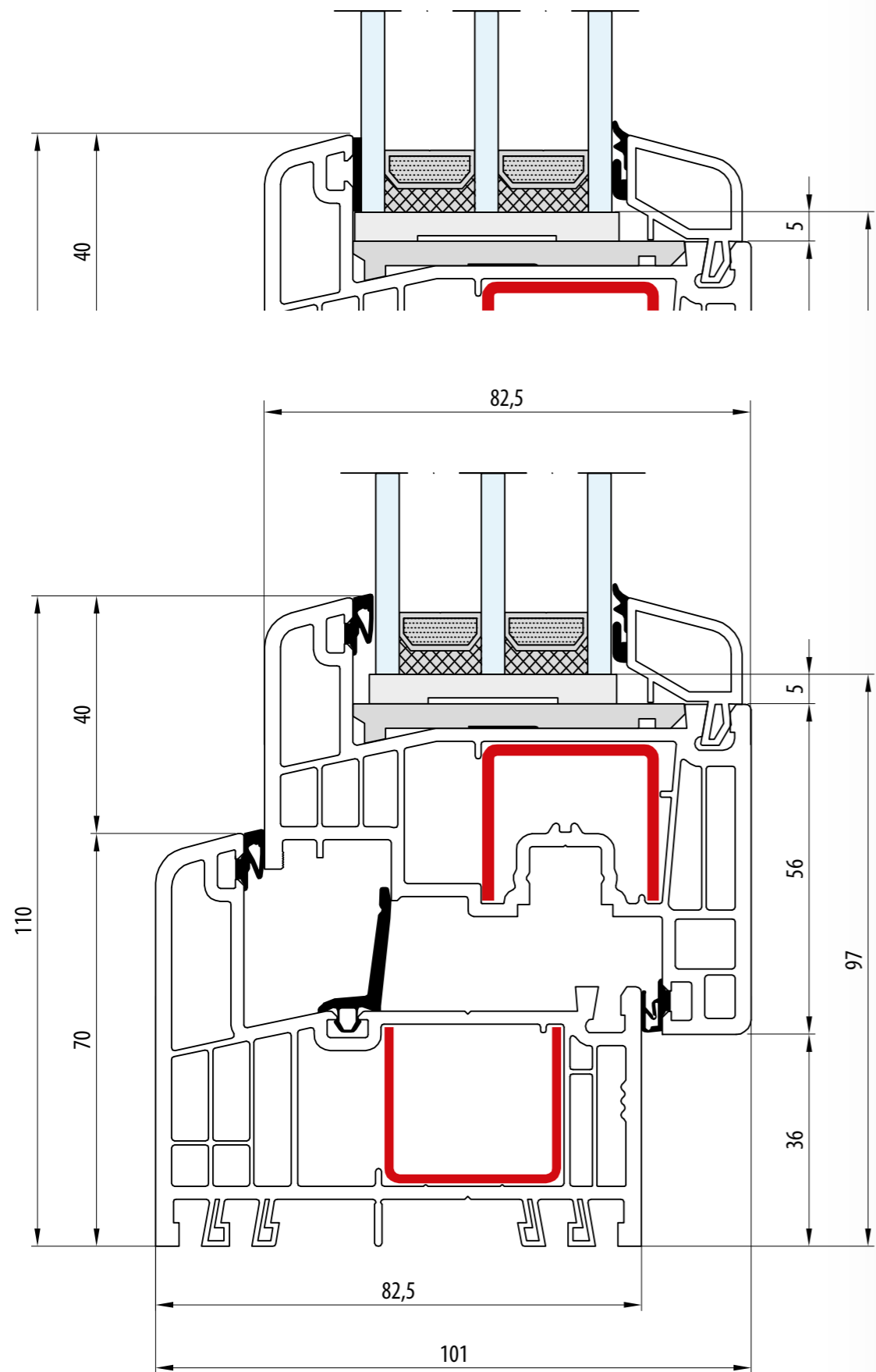

- Rama: 70 mm · Skrzydło: 74 mm
- Dormant: 70 mm · Vantail: 74 mm
- Frame: 70 mm · Sash: 74 mm
- Rahmen: 70 mm · Flügel: 74 mm
- Telaio: 70 mm · Anta: 74 mm

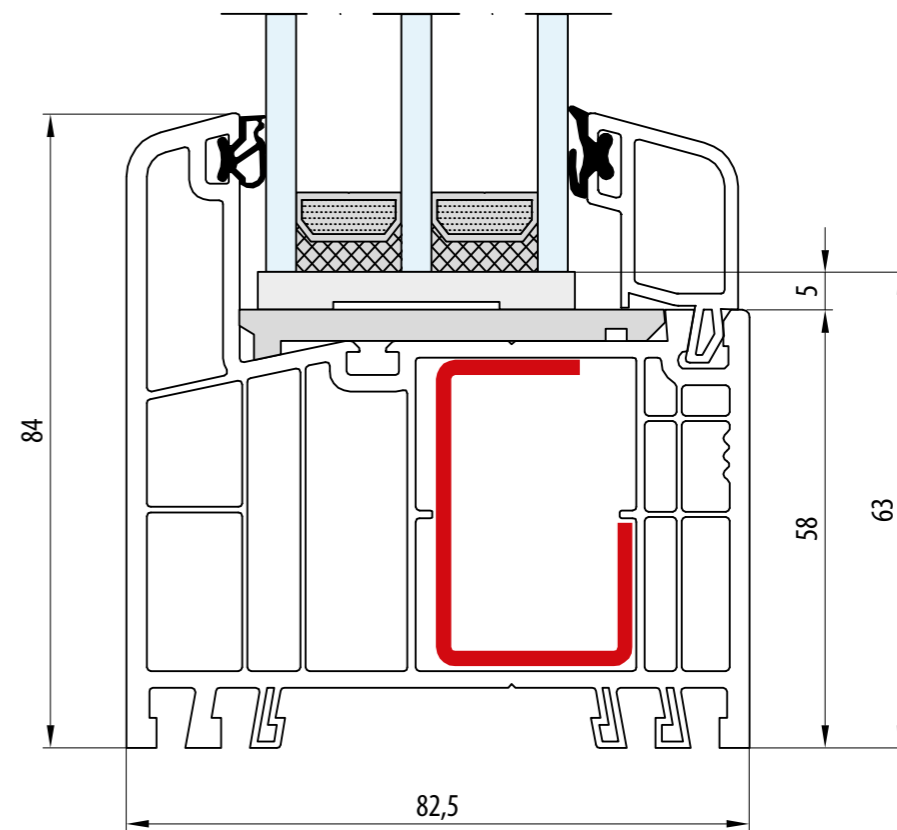
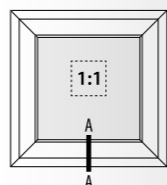

- Rama: 84 mm
- Dormant: 84 mm
- Frame: 84 mm
- Rahmen: 84 mm
- Telaio: 84 mm

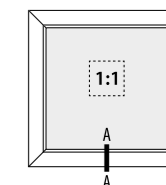

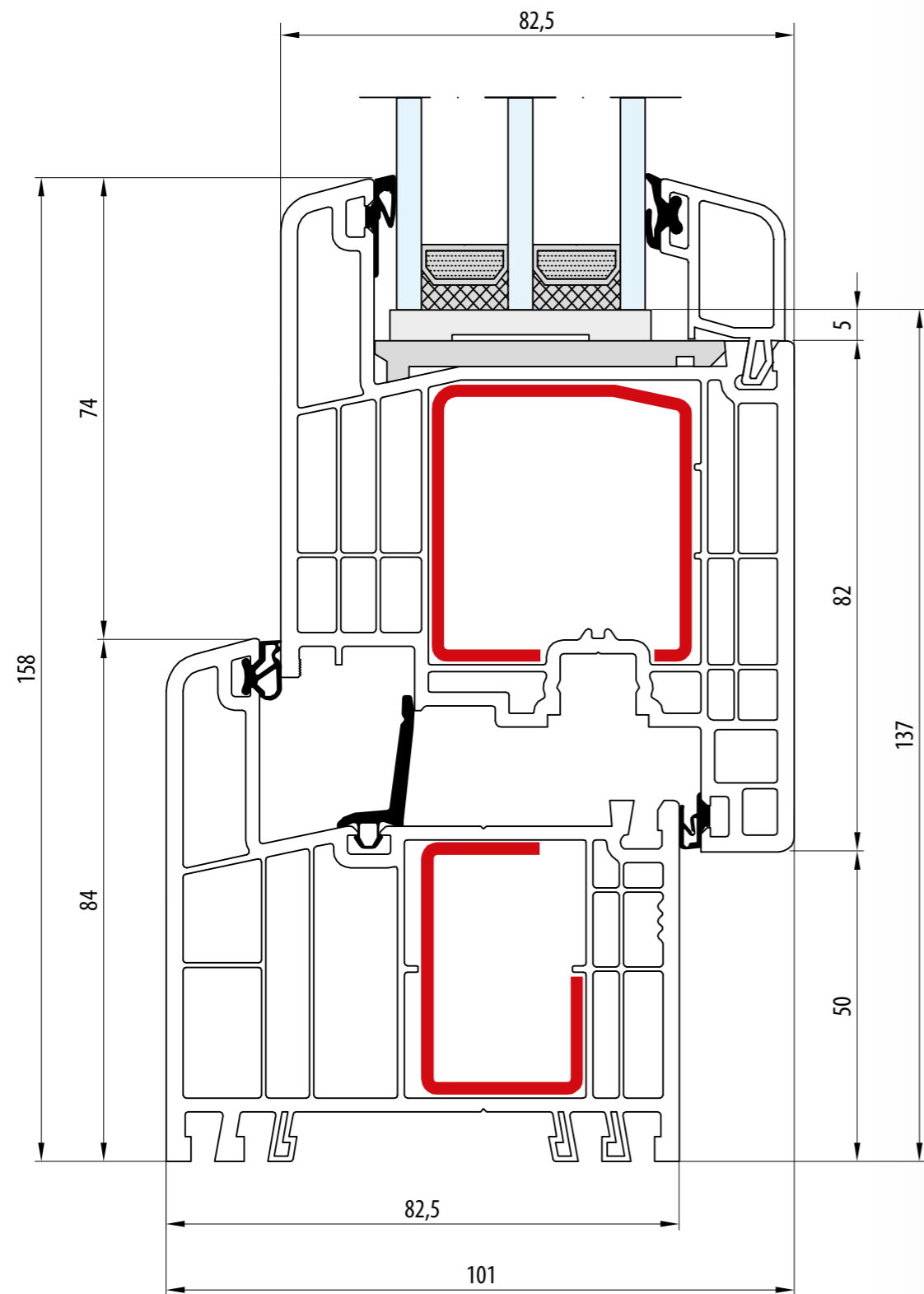

- Rama: 84 mm · Skrzydło: 108 mm
- Dormant: 84 mm · Vantail: 108 mm
- Frame: 84 mm · Sash: 108 mm
- Rahmen: 84 mm · Flügel: 108 mm
- Telaio: 84 mm · Anta: 108 mm

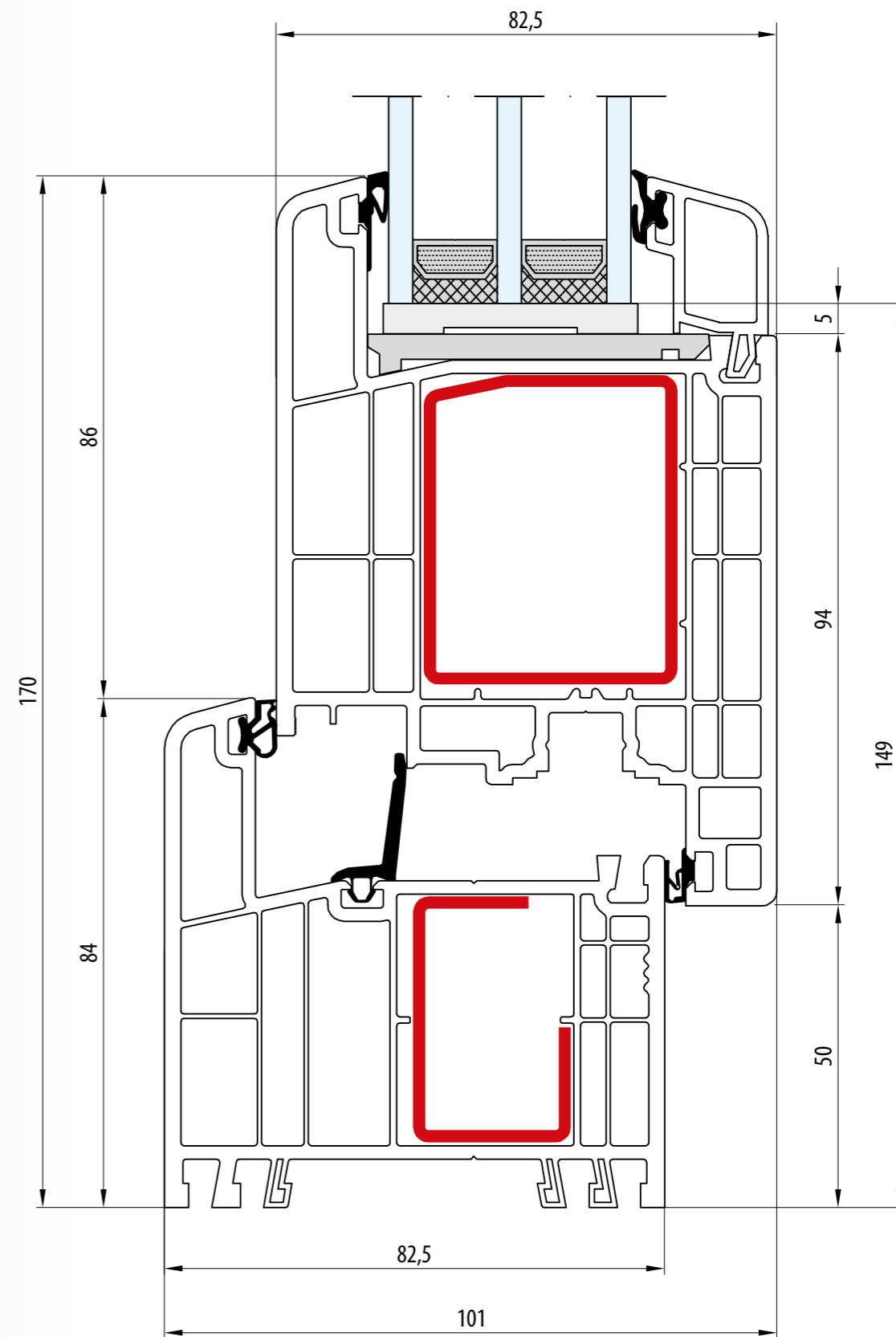
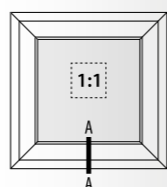

- Rama: 84 mm · Skrzydło: 120 mm
- Dormant: 84 mm · Vantail: 120 mm
- Frame: 84 mm · Sash: 120 mm
- Rahmen: 84 mm · Flügel: 120 mm
- Telaio: 84 mm · Anta: 120 mm

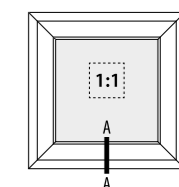

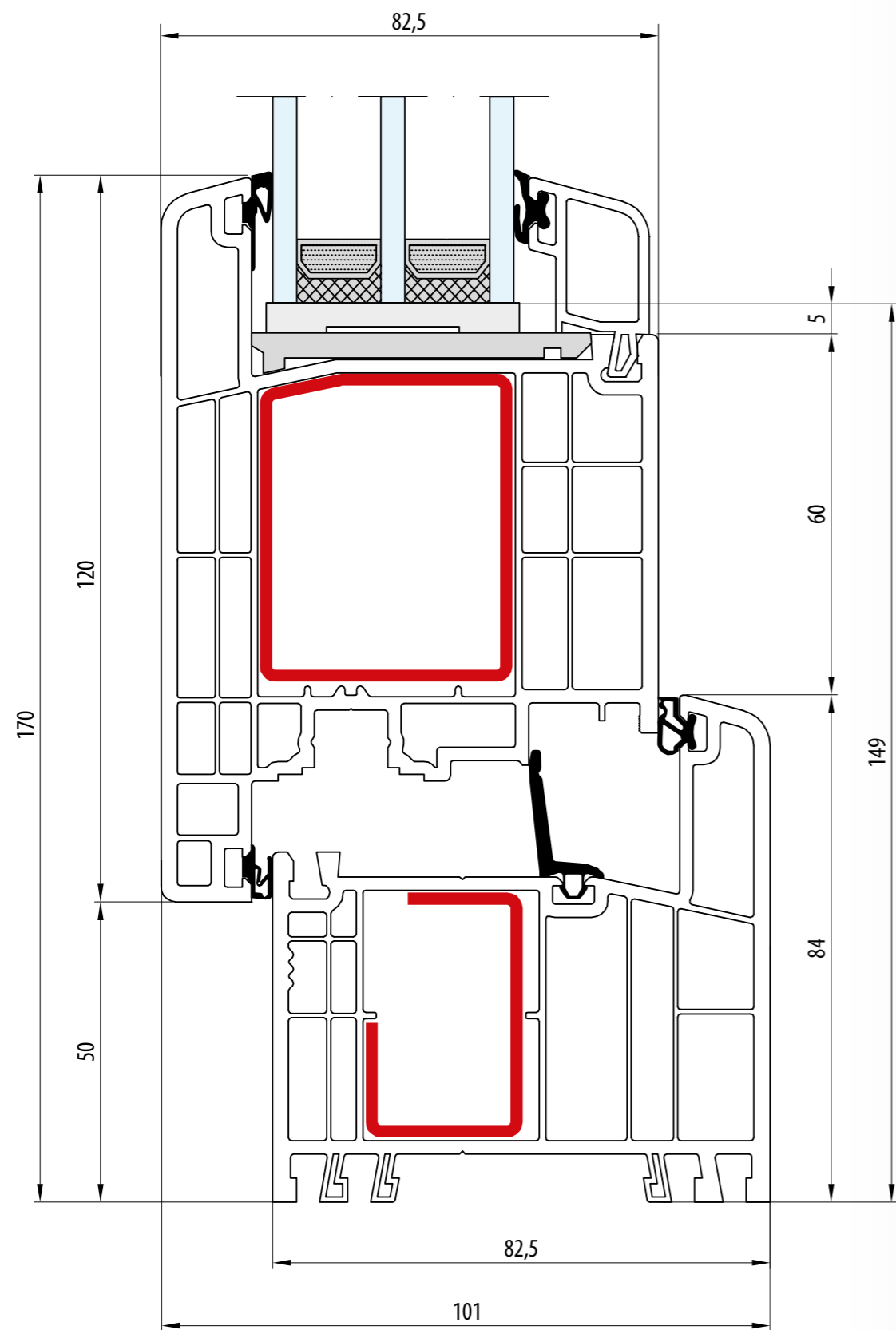

- Rama: 84 mm · Skrzydło: 120 mm
- Dormant: 84 mm · Vantail: 120 mm
- Frame: 84 mm · Sash: 120 mm
- Rahmen: 84 mm · Flügel: 120 mm
- Telaio: 84 mm · Anta: 120 mm

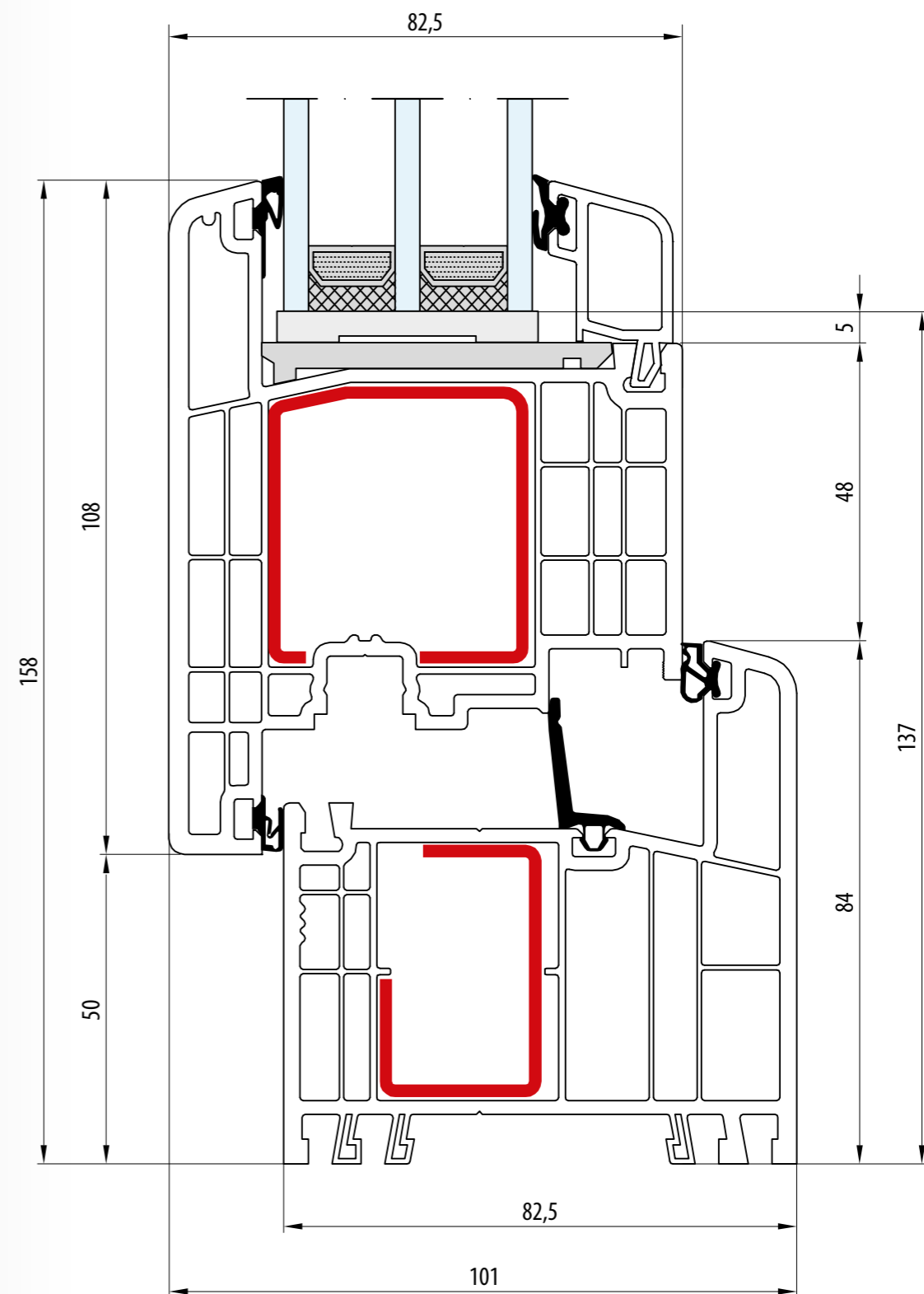
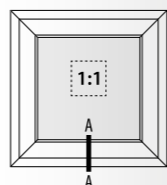

- Rama: 84 mm · Skrzydło: 108 mm
- Dormant: 84 mm · Vantail: 108 mm
- Frame: 84 mm · Sash: 108 mm
- Rahmen: 84 mm · Flügel: 108 mm
- Telaio: 84 mm · Anta: 108 mm

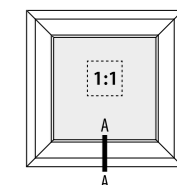



STV

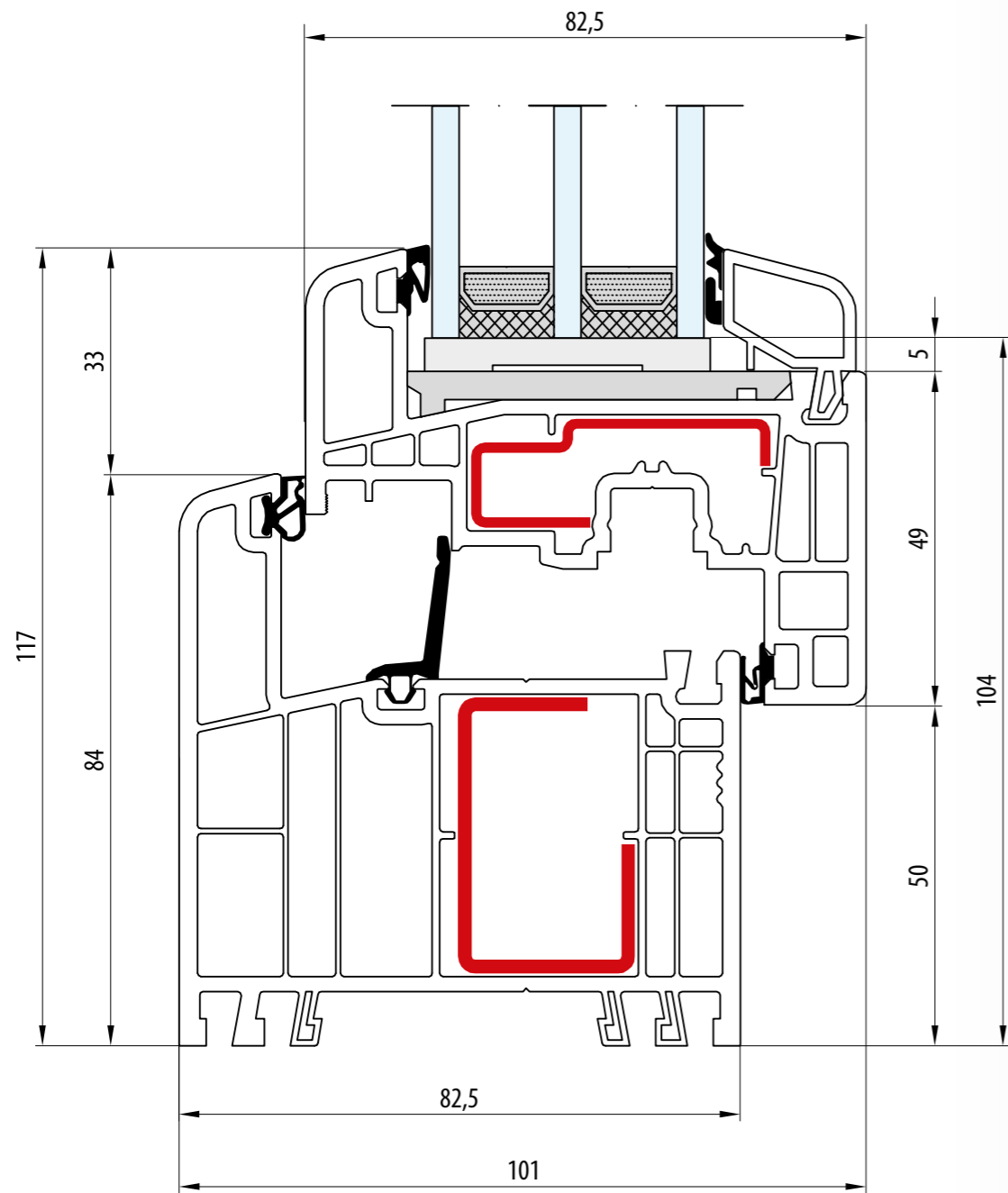
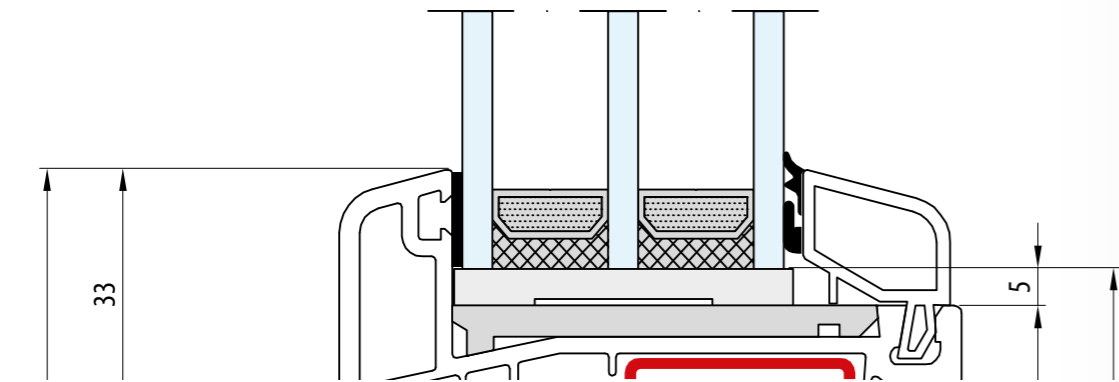

- Rama: 84 mm · Skrzydło: 67 mm
- Dormant: 84 mm · Vantail: 67 mm
- Frame: 84 mm · Sash: 67 mm
- Rahmen: 84 mm · Flügel: 67 mm
- Telaio: 84 mm · Anta: 67 mm

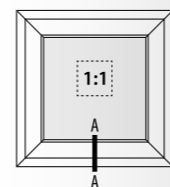

STV

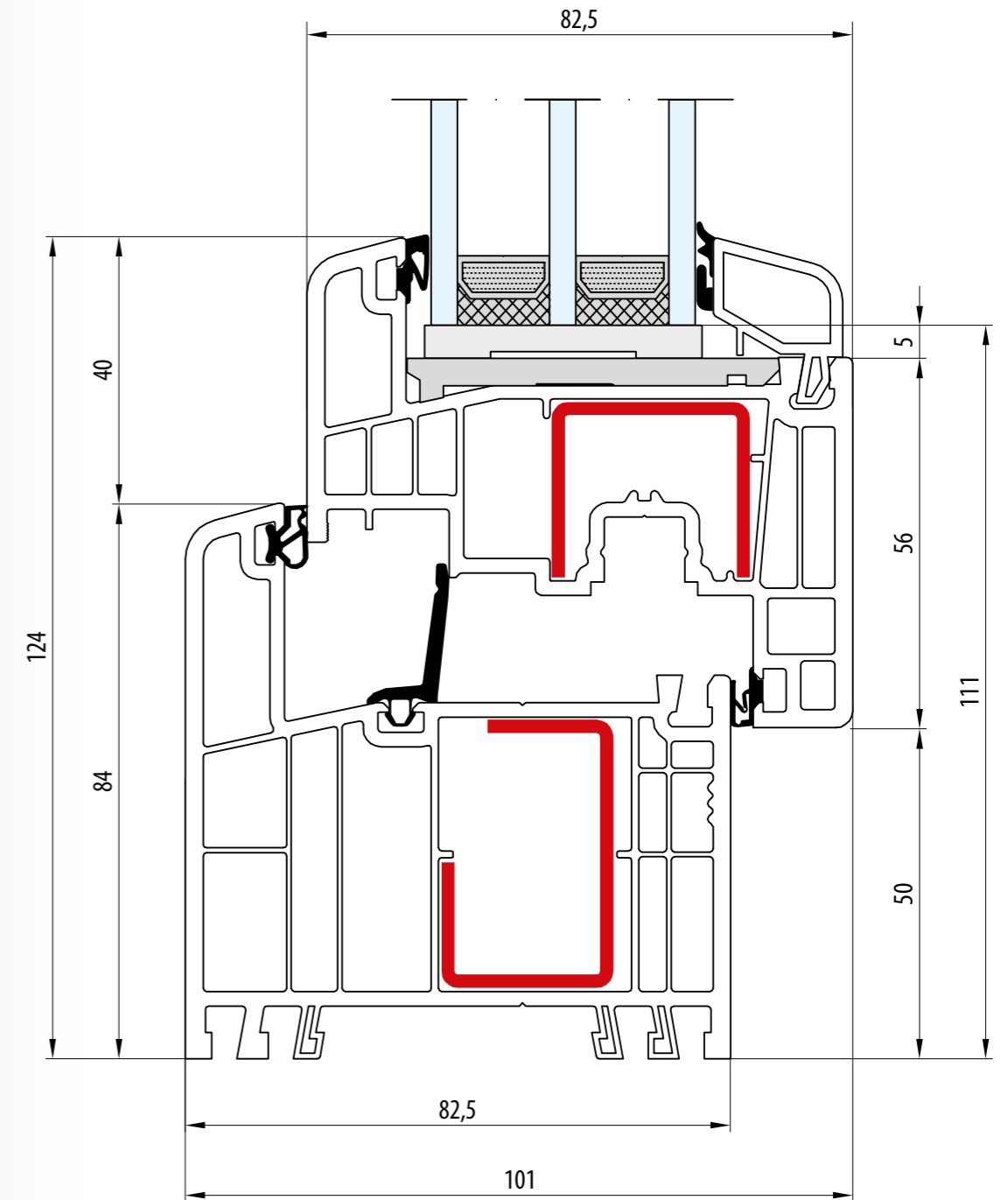
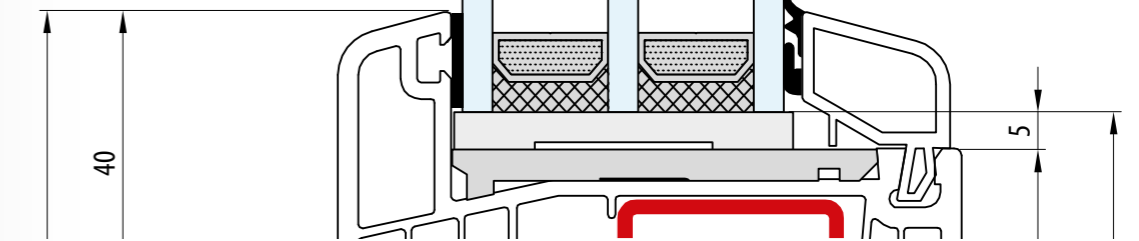

- Rama: 84 mm · Skrzydło: 74 mm
- Dormant: 84 mm · Vantail: 74 mm
- Frame: 84 mm · Sash: 74 mm
- Rahmen: 84 mm · Flügel: 74 mm
- Telaio: 84 mm · Anta: 74 mm

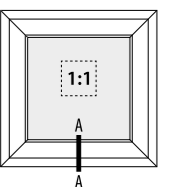

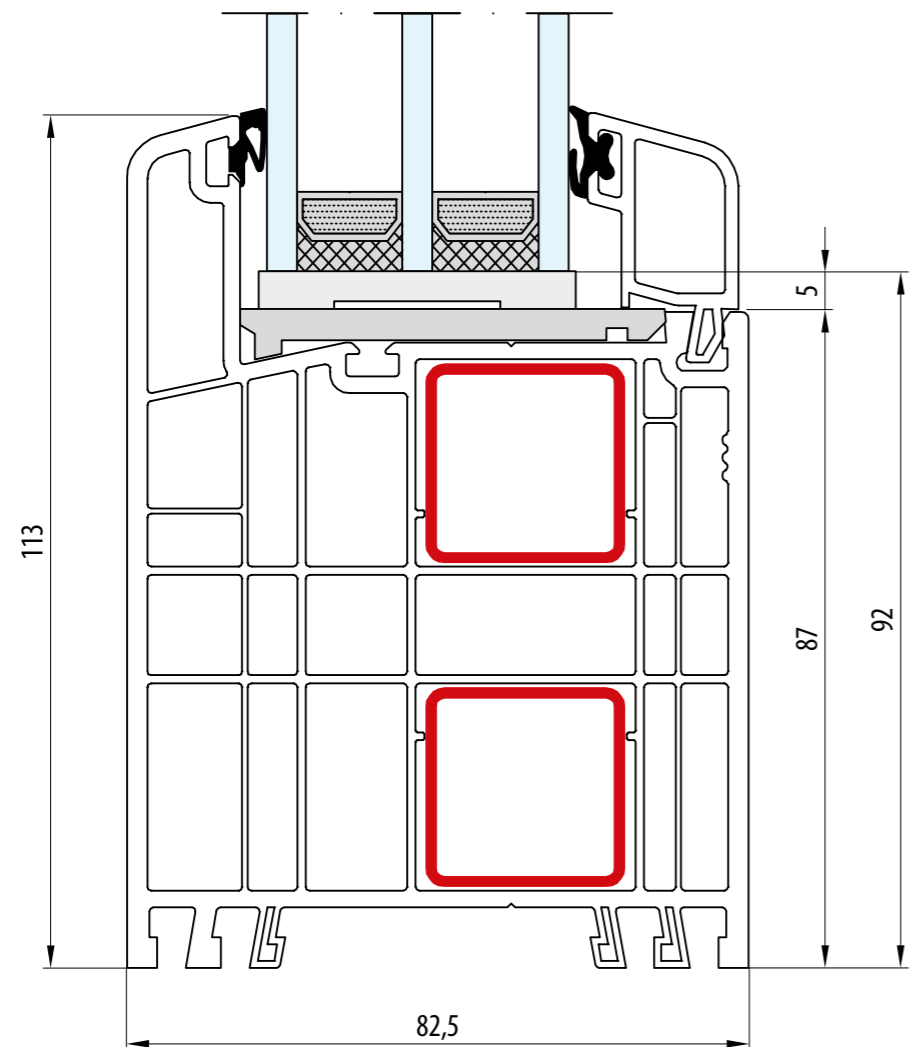

- Rama: 113 mm
- Dormant: 113 mm
- Frame: 113 mm
- Rahmen: 113 mm
- Telaio: 113 mm

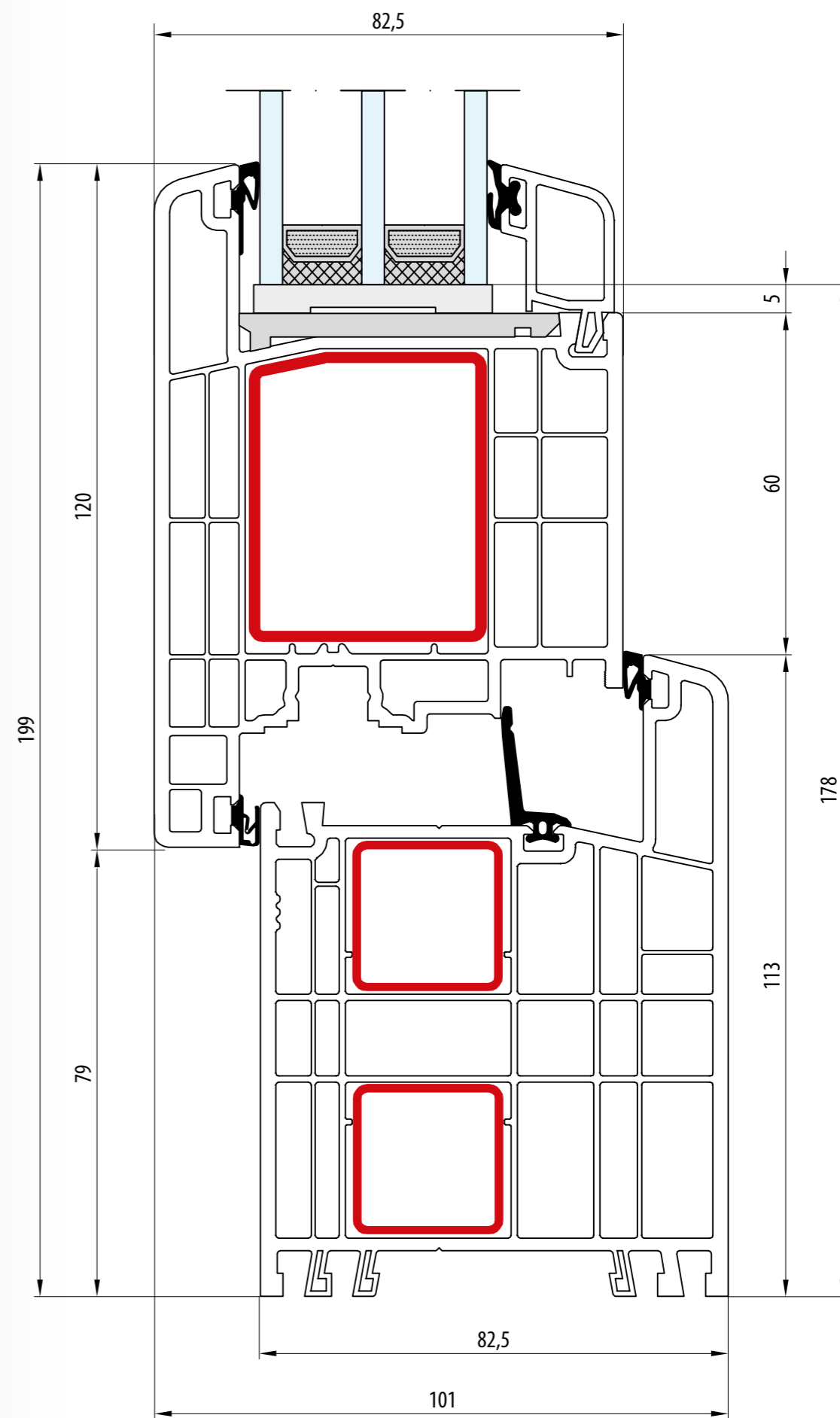
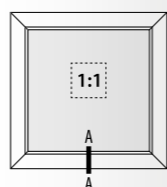

- Rama: 113 mm - Skrzydło: 120 mm
- Dormant: 113 mm - Vantail: 120 mm
- Frame: 113 mm - Sash: 120 mm
- Rahmen: 113 mm - Flügel: 120 mm
- Telaio: 113 mm - Anta: 120 mm

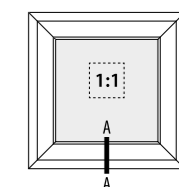

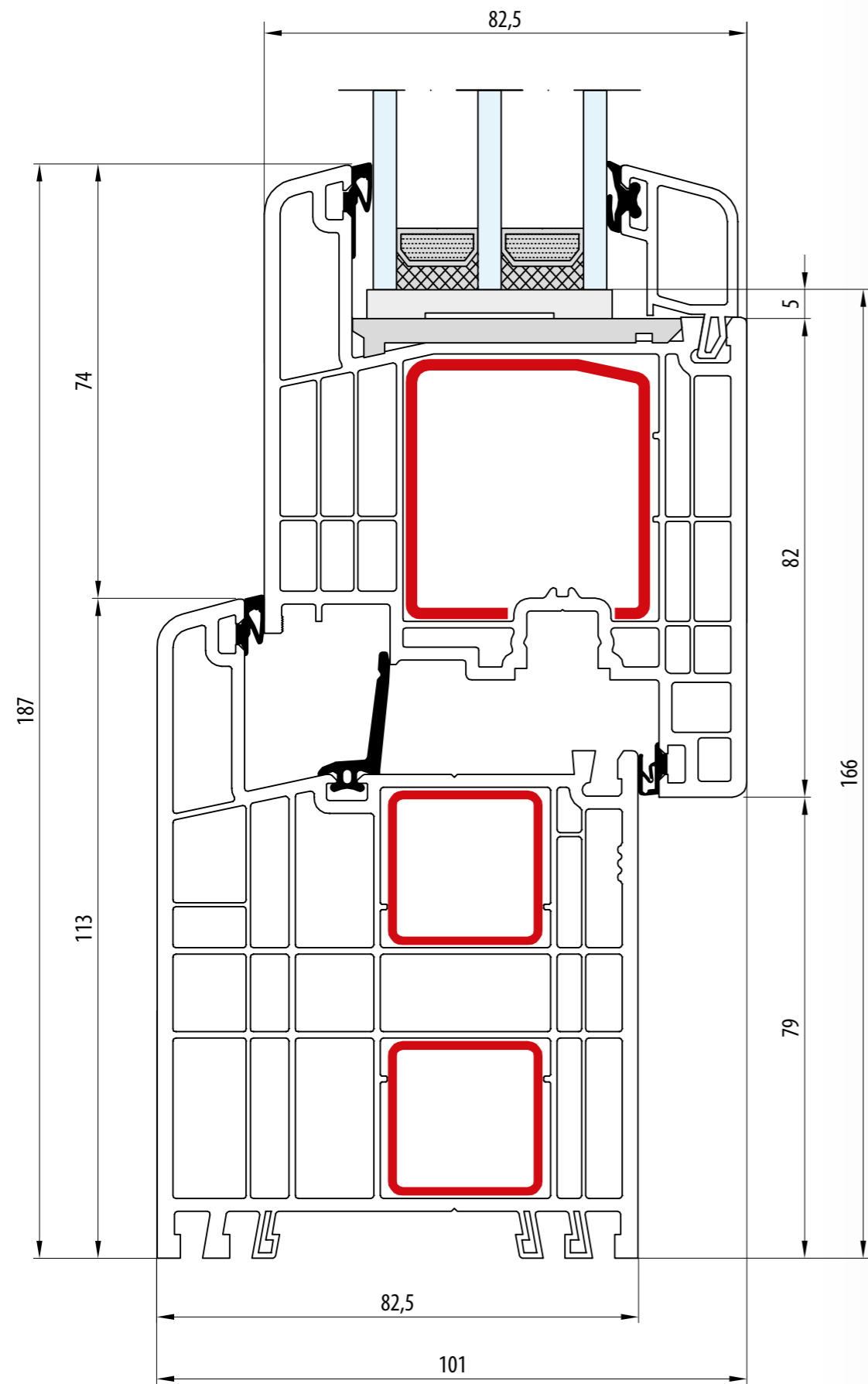

- Rama: 113 mm · Skrzydło: 108 mm
- Dormant: 113 mm · Vantail: 108 mm
- Frame: 113 mm · Sash: 108 mm
- Rahmen: 113 mm · Flügel: 108 mm
- Telaio: 113 mm · Anta: 108 mm

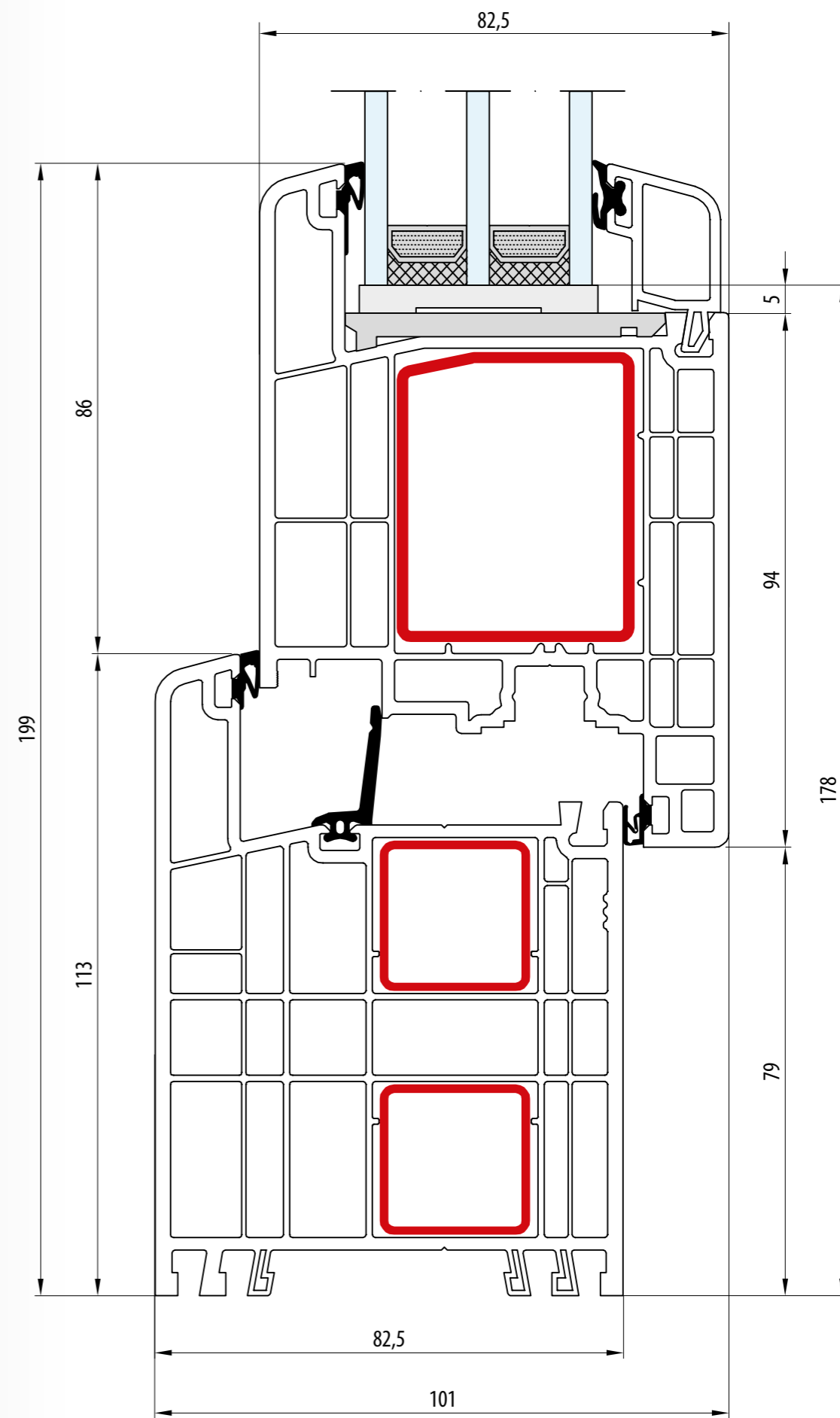
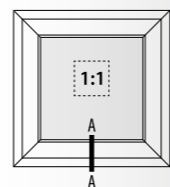

- Rama: 113 mm · Skrzydło: 120 mm
- Dormant: 113 mm · Vantail: 120 mm
- Frame: 113 mm · Sash: 120 mm
- Rahmen: 113 mm · Flügel: 120 mm
- Telaio: 113 mm · Anta: 120 mm

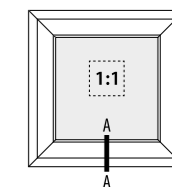

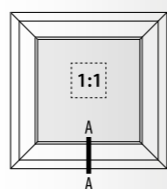
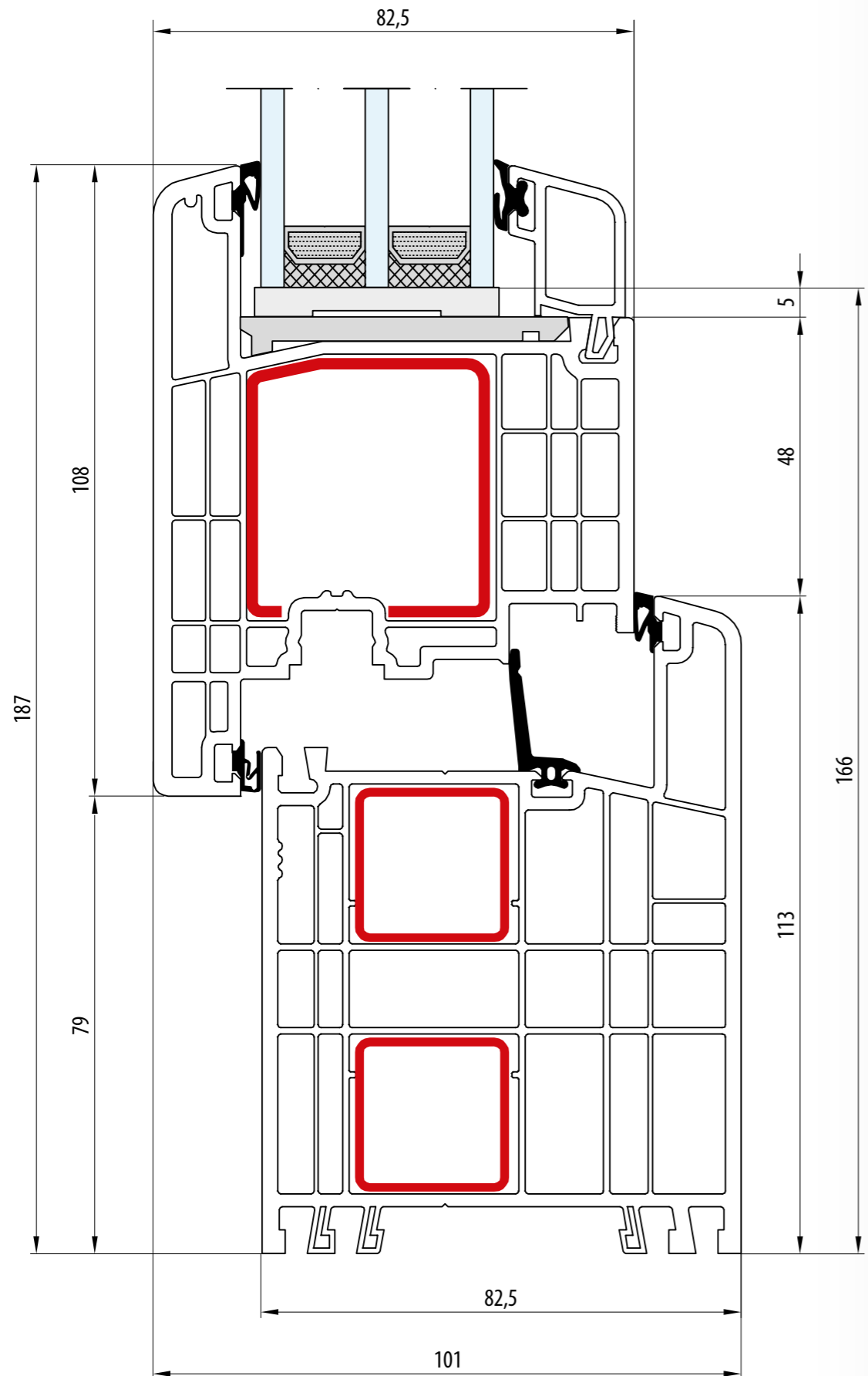

- Rama: 113 mm · Skrzydło: 108 mm
- Dormant: 113 mm · Vantail: 108 mm
- Frame: 113 mm · Sash: 108 mm
- Rahmen: 113 mm · Flügel: 108 mm
- Telaio: 113 mm · Anta: 108 mm

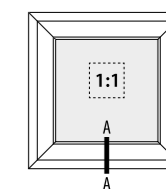
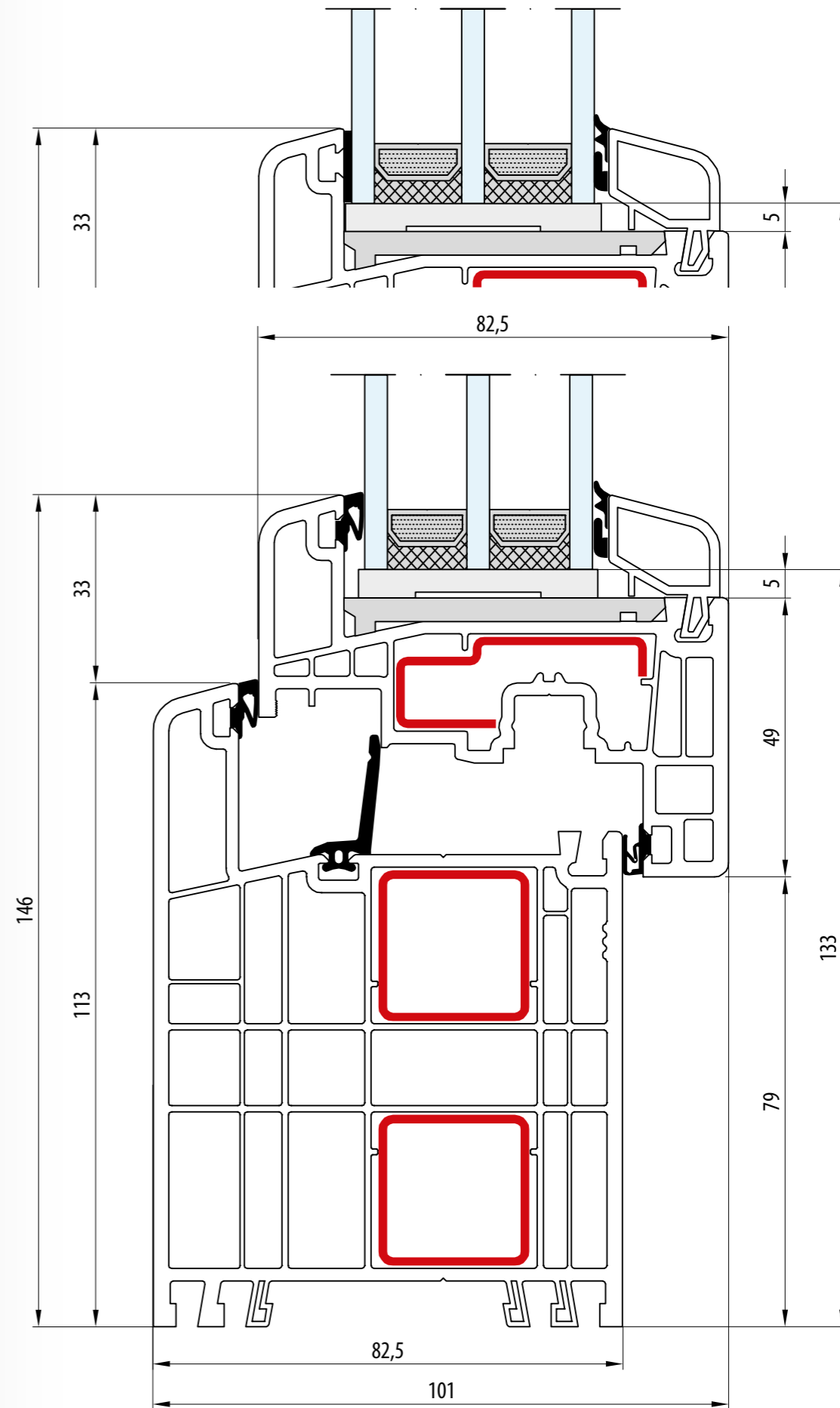

- Rama: 113 mm · Skrzydło: 67 mm
- Dormant: 113 mm · Vantail: 67 mm
- Frame: 113 mm · Sash: 67 mm
- Rahmen: 113 mm · Flügel: 67 mm
- Telaio: 113 mm · Anta: 67 mm





STV

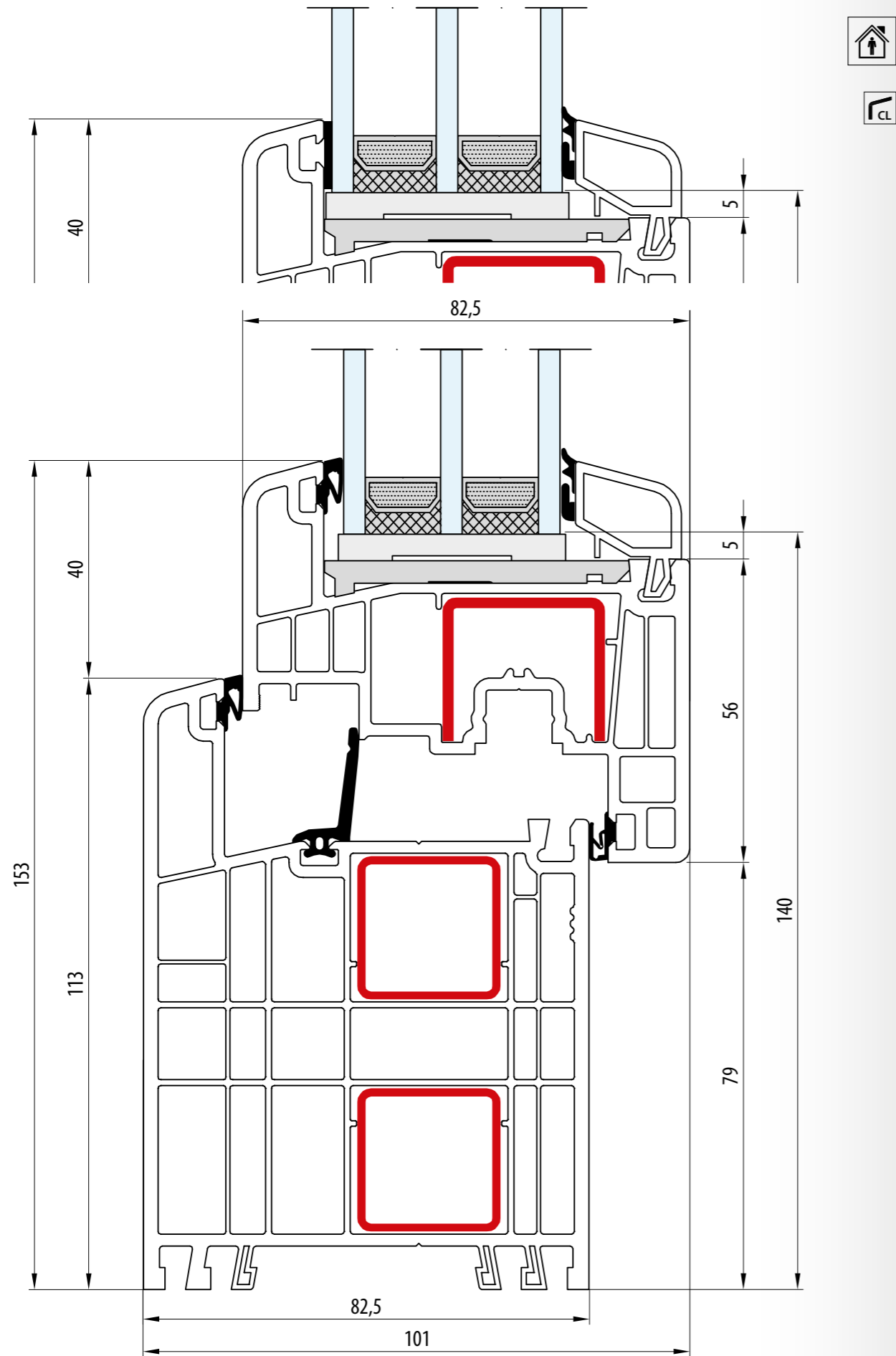

- Rama: 113 mm · Skrzydło: 74 mm
- Dormant: 113 mm · Vantail: 74 mm
- Frame: 113 mm · Sash: 74 mm
- Rahmen: 113 mm · Flügel: 74 mm
- Telaio: 113 mm · Anta: 74 mm

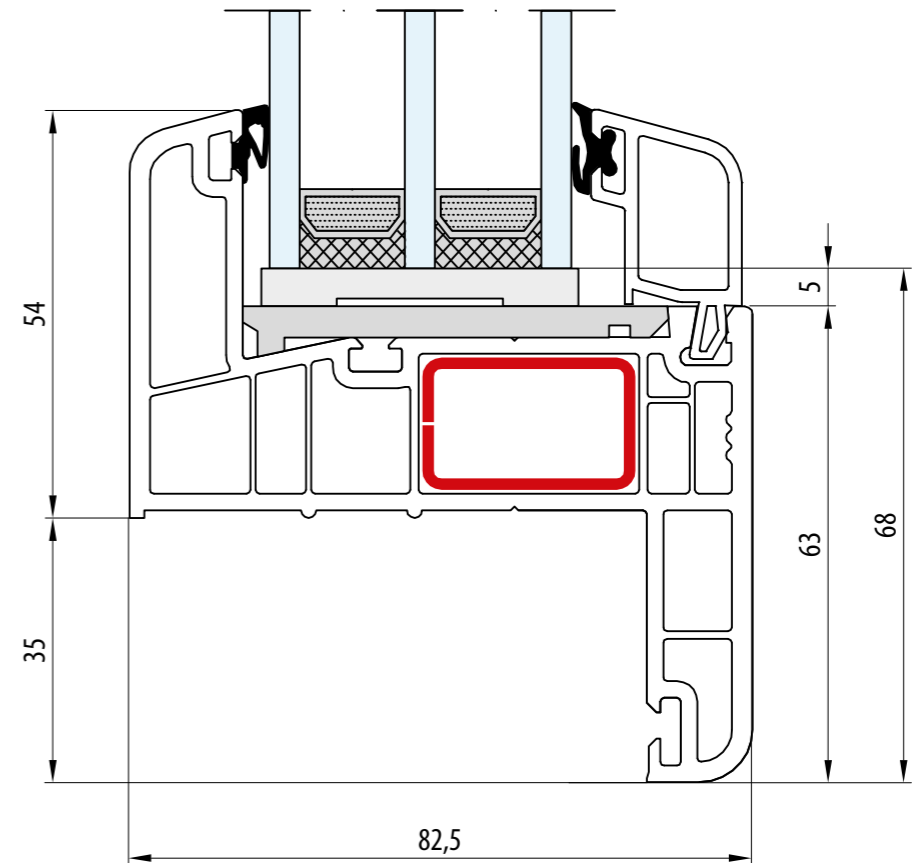
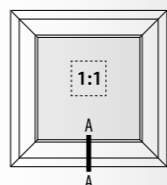

- RENOWACJA - Pletwa: 35 mm · Rama: 54 mm
- RÉNOVATION - Lip: 35 mm · Dormant: 54 mm
- RENOVATION - Strip: 35 mm · Frame: 54 mm
- RENOVIERUNG - Flosse: 35 mm · Rahmen: 54 mm
- RINNOVAZIONE - Aletta da: 35 mm · Telaio: 54 mm

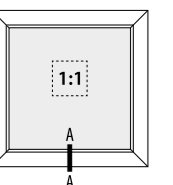

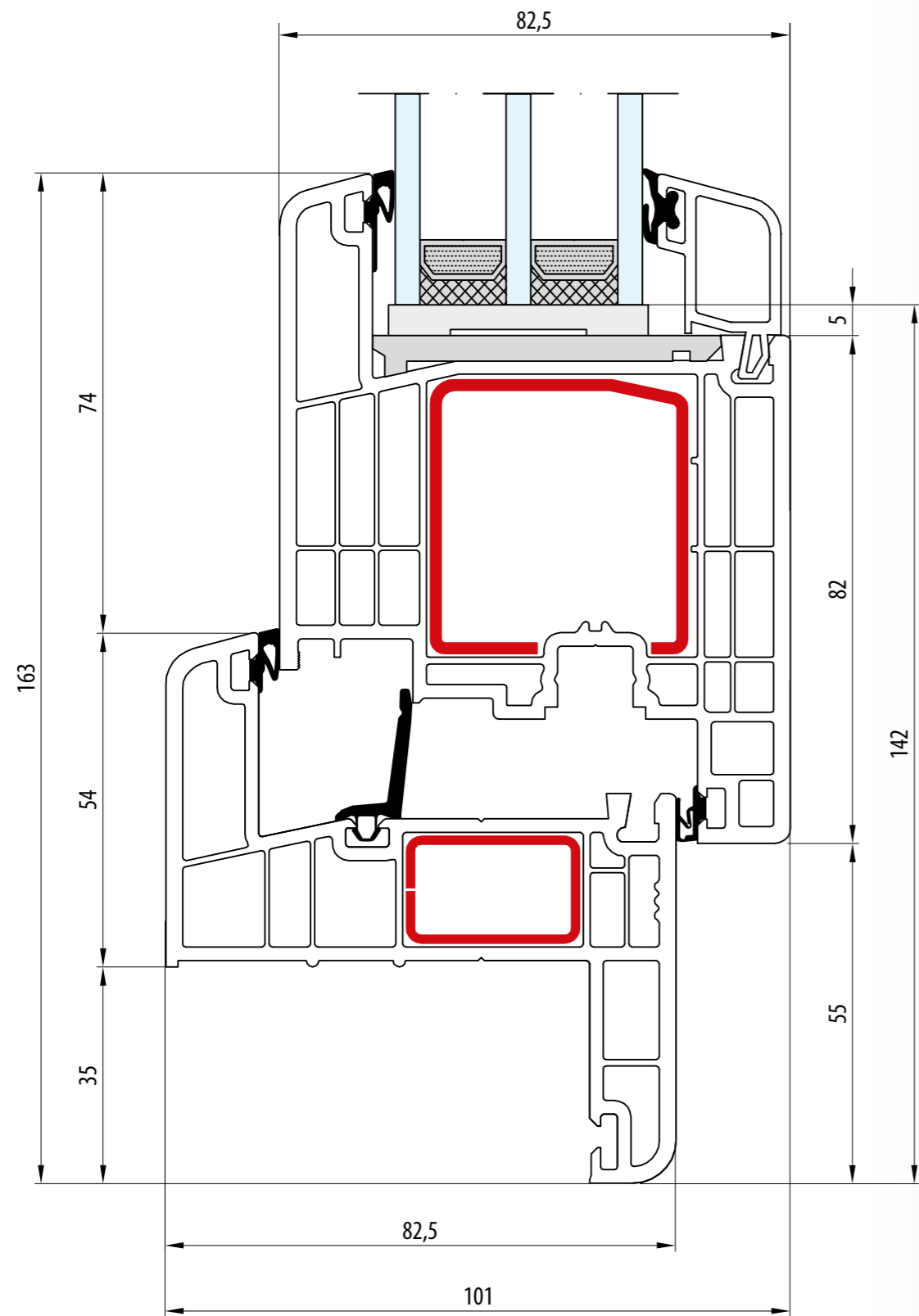

- RENOWACJA - Pletwa: 35 mm · Rama: 54 mm · Skrzydło: 108 mm
- RÉNOVATION - Lip: 35 mm · Dormant: 54 mm · Vantail: 108 mm
- RENOVATION - Strip: 35 mm · Frame: 54 mm · Sash: 108 mm
- RENOVIERUNG - Flosse: 35 mm · Rahmen: 54 mm · Flügel: 108 mm
- RINNOVAZIONE - Aletta da: 35 mm · Telaio: 54 mm · Anta: 108 mm

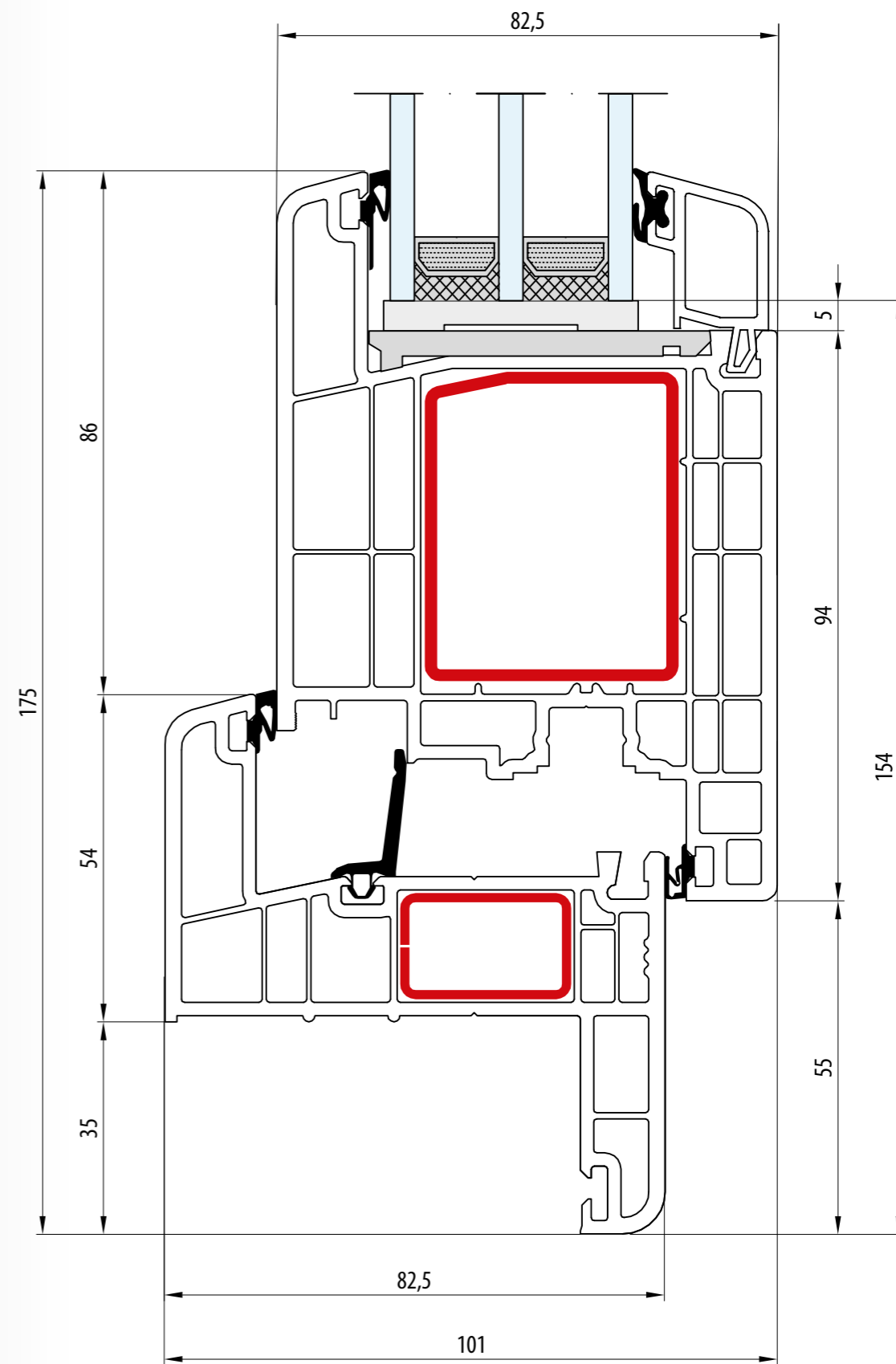
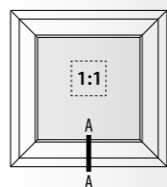

- RENOWACJA - Pletwa: 35 mm · Rama: 54 mm · Skrzydło: 120 mm
- RÉNOVATION - Lip: 35 mm · Dormant: 54 mm · Vantail: 120 mm
- RENOVATION - Strip: 35 mm · Frame: 54 mm · Sash: 120 mm
- RENOVIERUNG - Flosse: 35 mm · Rahmen: 54 mm · Flügel: 120 mm
- RINNOVAZIONE - Aletta da: 35 mm · Telaio: 54 mm · Anta: 120 mm

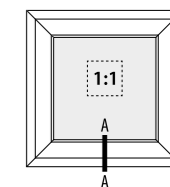



STV

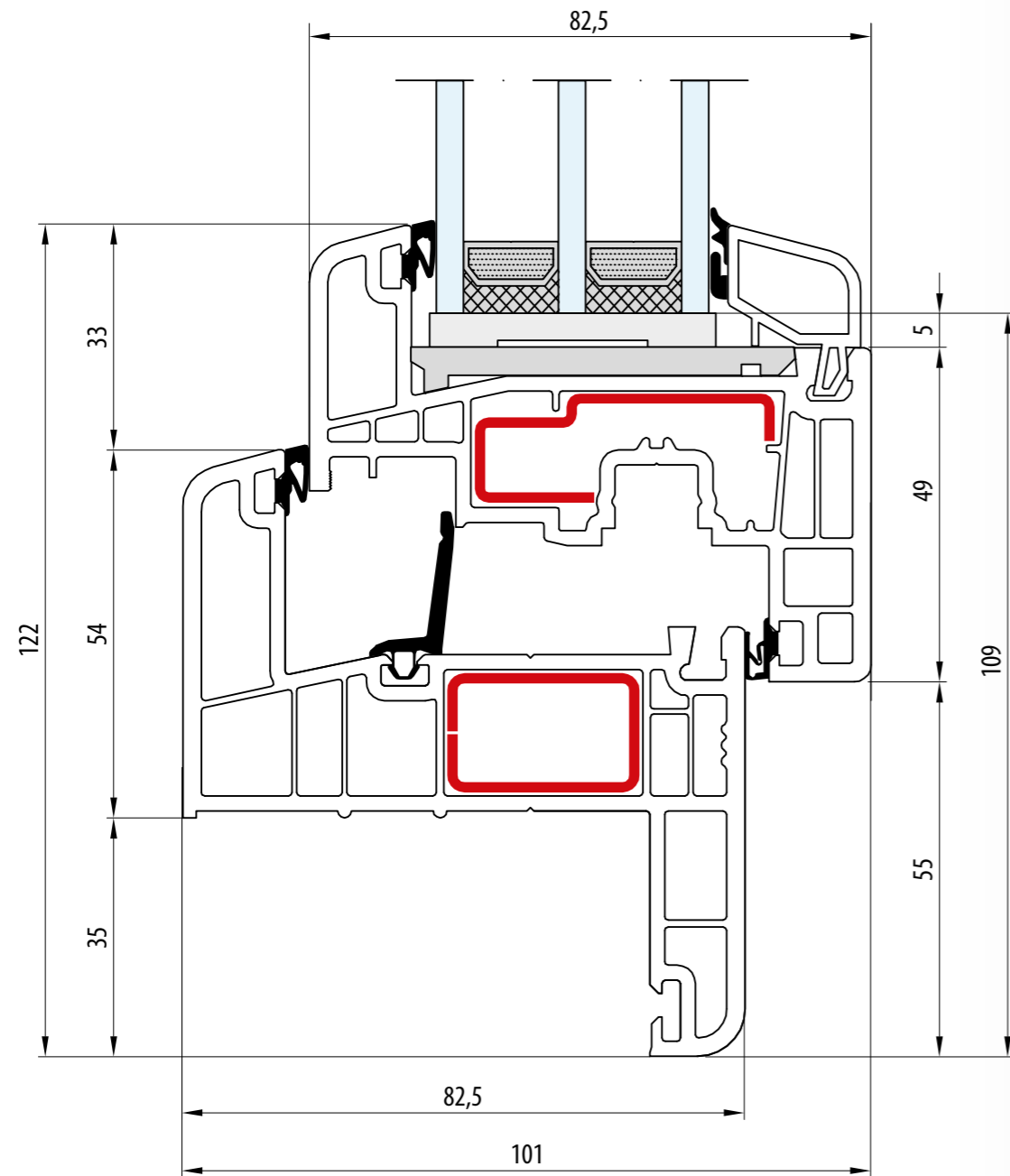
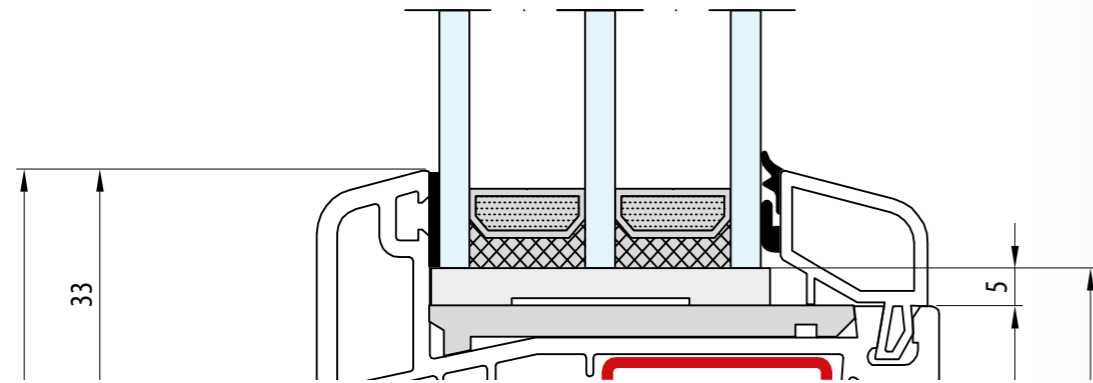

- RENOWACJA - Pletwa: 35 mm · Rama: 54 mm · Skrzydło: 67 mm
- RÉNOVATION - Lip: 35 mm · Dormant: 54 mm · Vantail: 67 mm
- RENOVATION - Strip: 35 mm · Frame: 54 mm · Sash: 67 mm
- RENOVIERUNG - Flosse: 35 mm · Rahmen: 54 mm · Flügel: 67 mm
- RINNOVAZIONE - Aletta da: 35 mm · Telaio: 54 mm · Anta: 67 mm

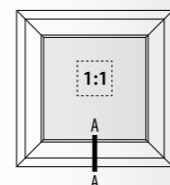

STV

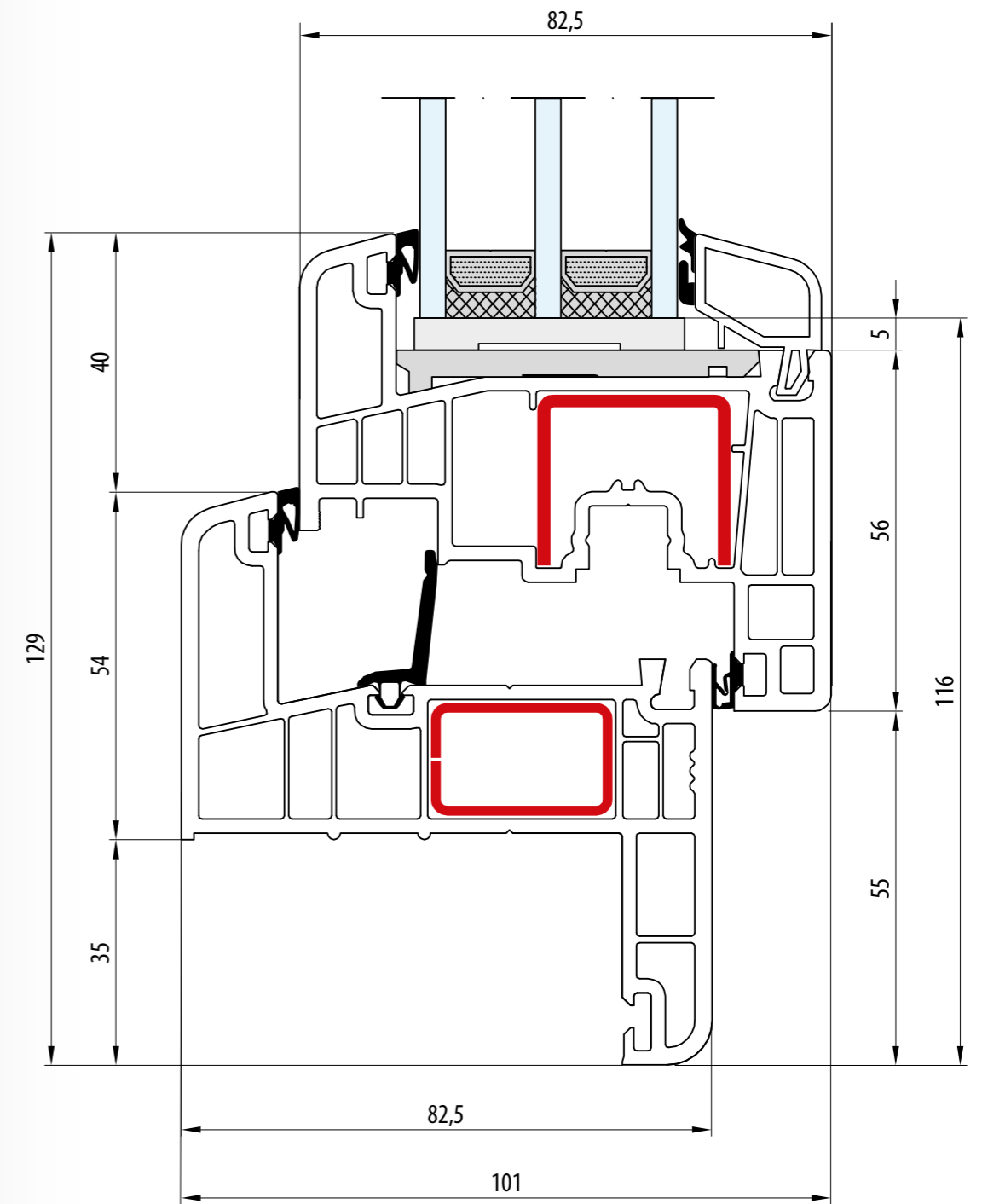
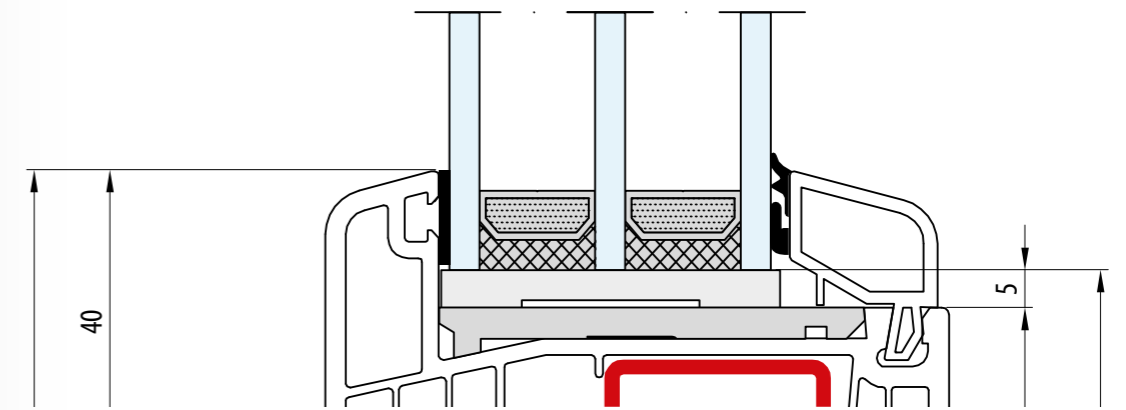

- RENOWACJA - Pletwa: 35 mm · Rama: 54 mm · Skrzydło: 74 mm
- RÉNOVATION - Lip: 35 mm · Dormant: 54 mm · Vantail: 74 mm
- RENOVATION - Strip: 35 mm · Frame: 54 mm · Sash: 74 mm
- RENOVIERUNG - Flosse: 35 mm · Rahmen: 54 mm · Flügel: 74 mm
- RINNOVAZIONE - Aletta da: 35 mm · Telaio: 54 mm · Anta: 74 mm

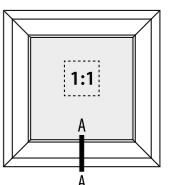

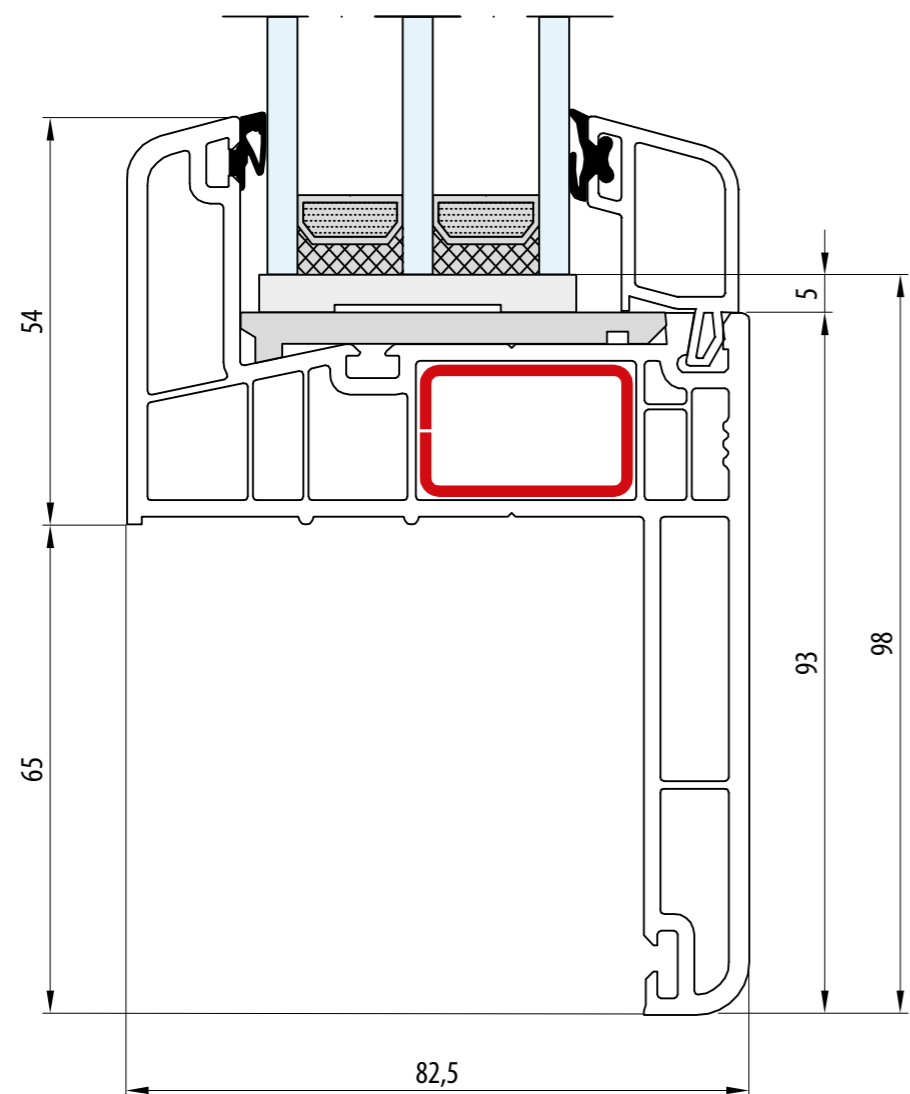

- RENOWACJA - Pletwa: 65 mm · Rama: 54 mm
- RÉNOVATION - Lip: 65 mm · Dormant: 54 mm
- RENOVATION - Strip: 65 mm · Frame: 54 mm
- RENOVIERUNG - Flosse: 65 mm · Rahmen: 54 mm
- RINNOVAZIONE - Aletta da: 65 mm · Telaio: 54 mm

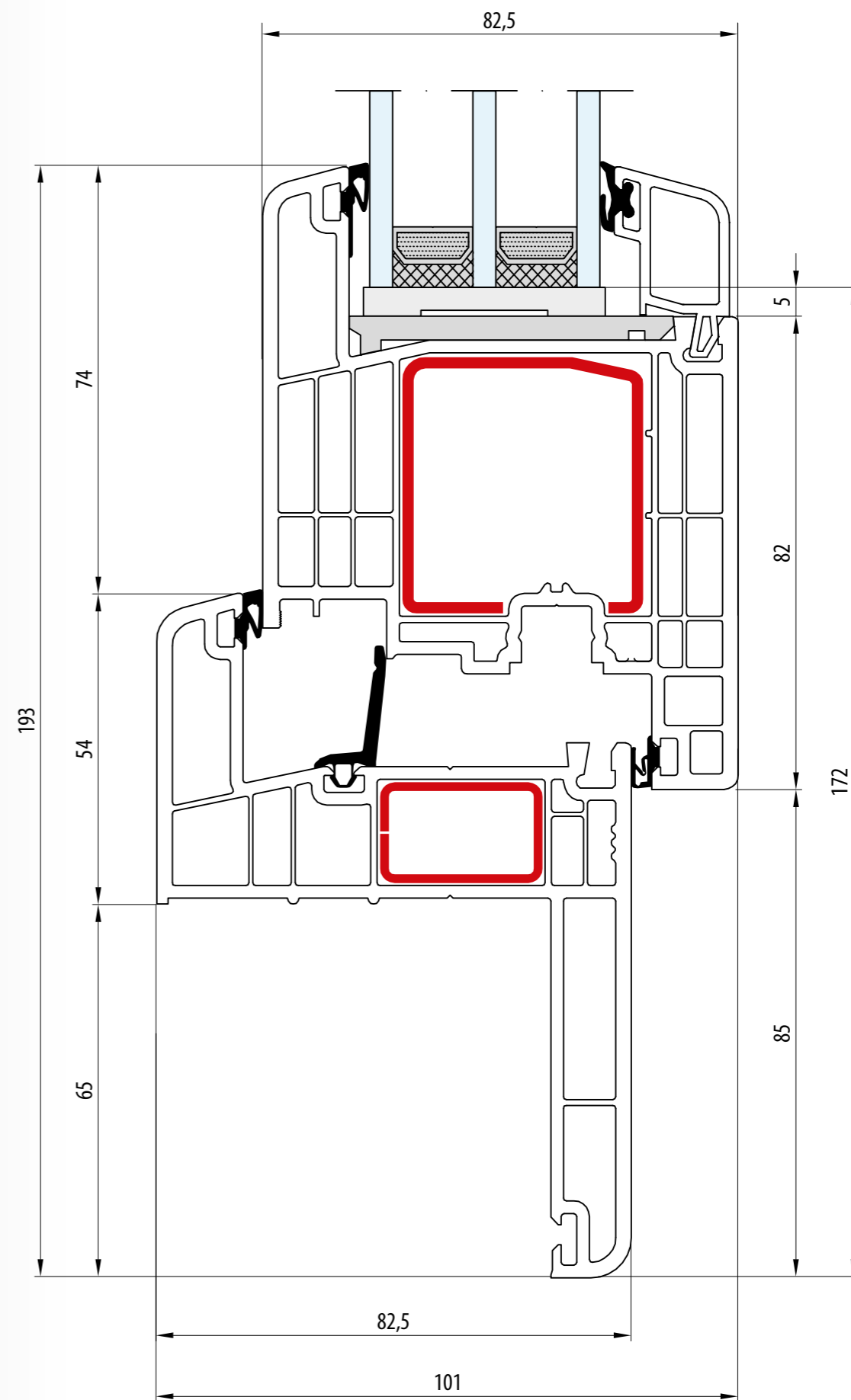
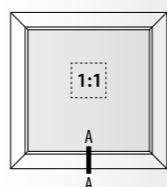

- RENOWACJA - Pletwa: 65 mm · Rama: 54 mm · Skrzydło: 108 mm
- RÉNOVATION - Lip: 65 mm · Dormant: 54 mm · Vantail: 108 mm
- RENOVATION - Strip: 65 mm · Frame: 54 mm · Sash: 108 mm
- RENOVIERUNG - Flosse: 65 mm · Rahmen: 54 mm · Flügel: 108 mm
- RINNOVAZIONE - Aletta da: 65 mm · Telaio: 54 mm · Anta: 108 mm

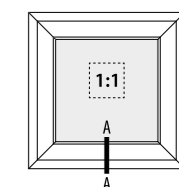

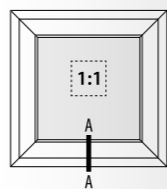
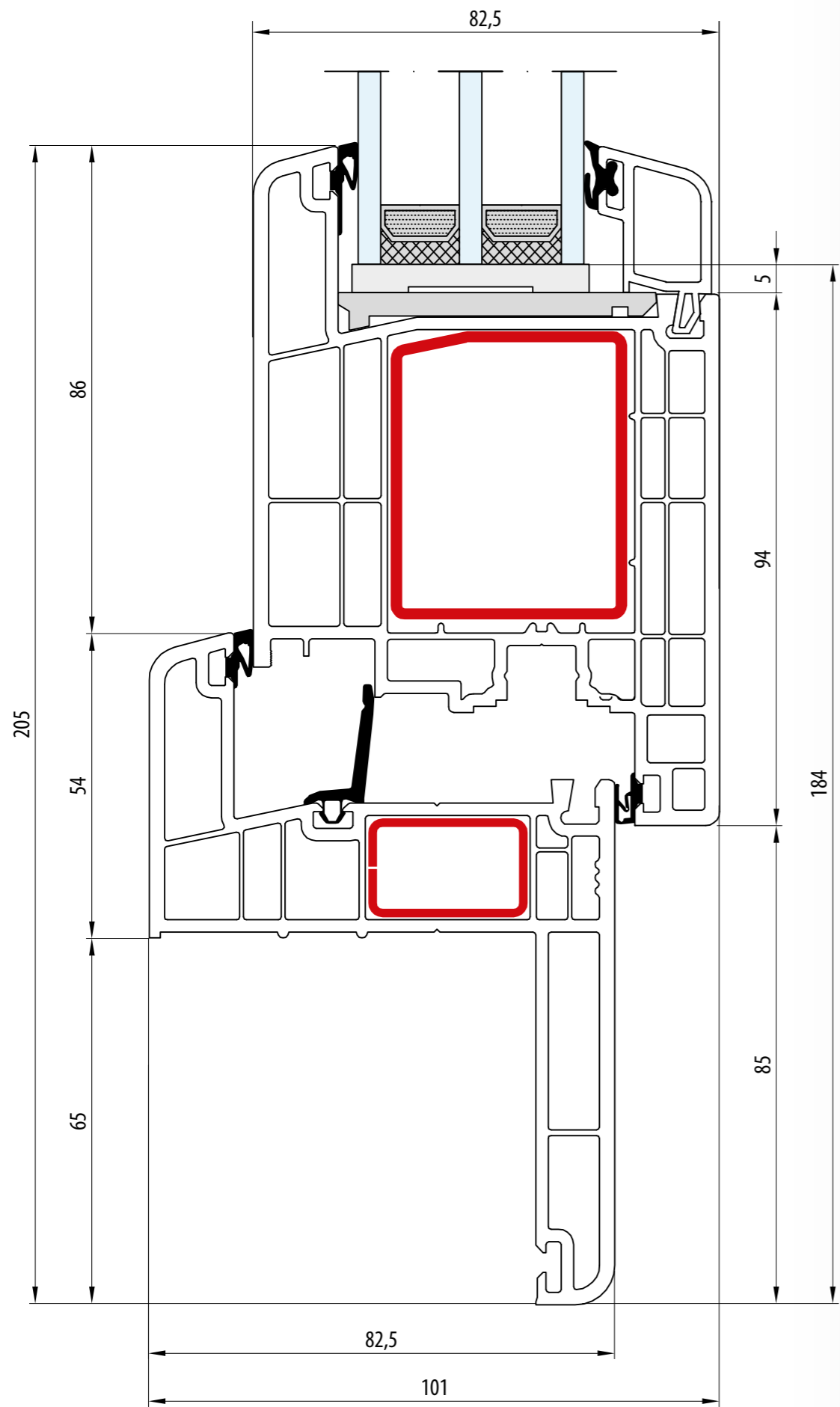

- RENOWACJA - Pletwa: 65 mm · Rama: 54 mm · Skrzydło: 120 mm
- RÉNOVATION - Lip: 65 mm · Dormant: 54 mm · Vantail: 120 mm
- RENOVATION - Strip: 65 mm · Frame: 54 mm · Sash: 120 mm
- RENOVIERUNG - Flosse: 65 mm · Rahmen: 54 mm · Flügel: 120 mm
- RINNOVAZIONE - Aletta da: 65 mm · Telaio: 54 mm · Anta: 120 mm



STV

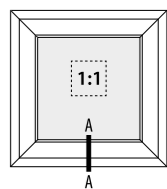
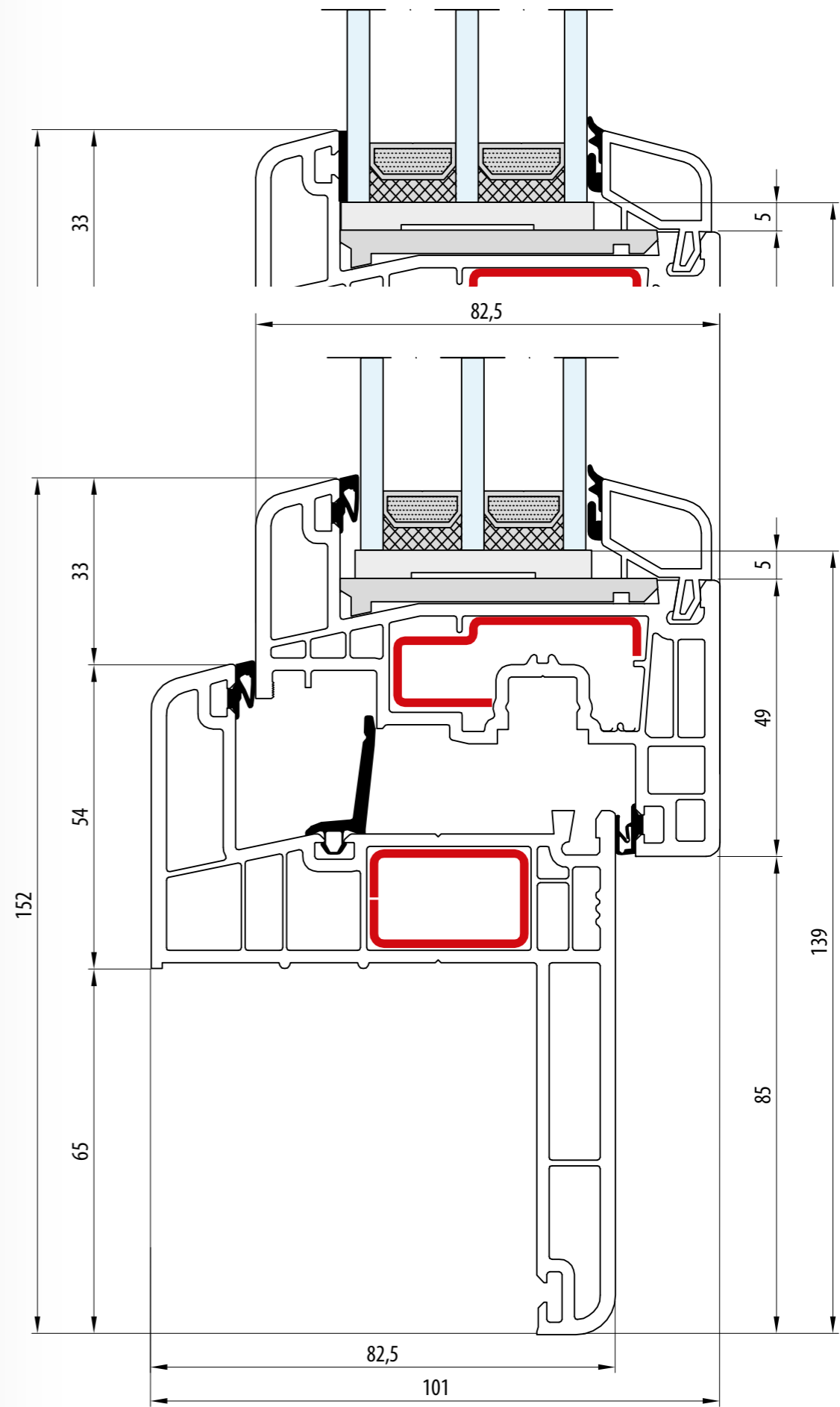

- RENOWACJA - Pletwa: 65 mm · Rama: 54 mm · Skrzydło: 67 mm
- RÉNOVATION - Lip: 65 mm · Dormant: 54 mm · Vantail: 67 mm
- RENOVATION - Strip: 65 mm · Frame: 54 mm · Sash: 67 mm
- RENOVIERUNG - Flosse: 65 mm · Rahmen: 54 mm · Flügel: 67 mm
- RINNOVAZIONE - Aletta da: 65 mm · Telaio: 54 mm · Anta: 67 mm



STV

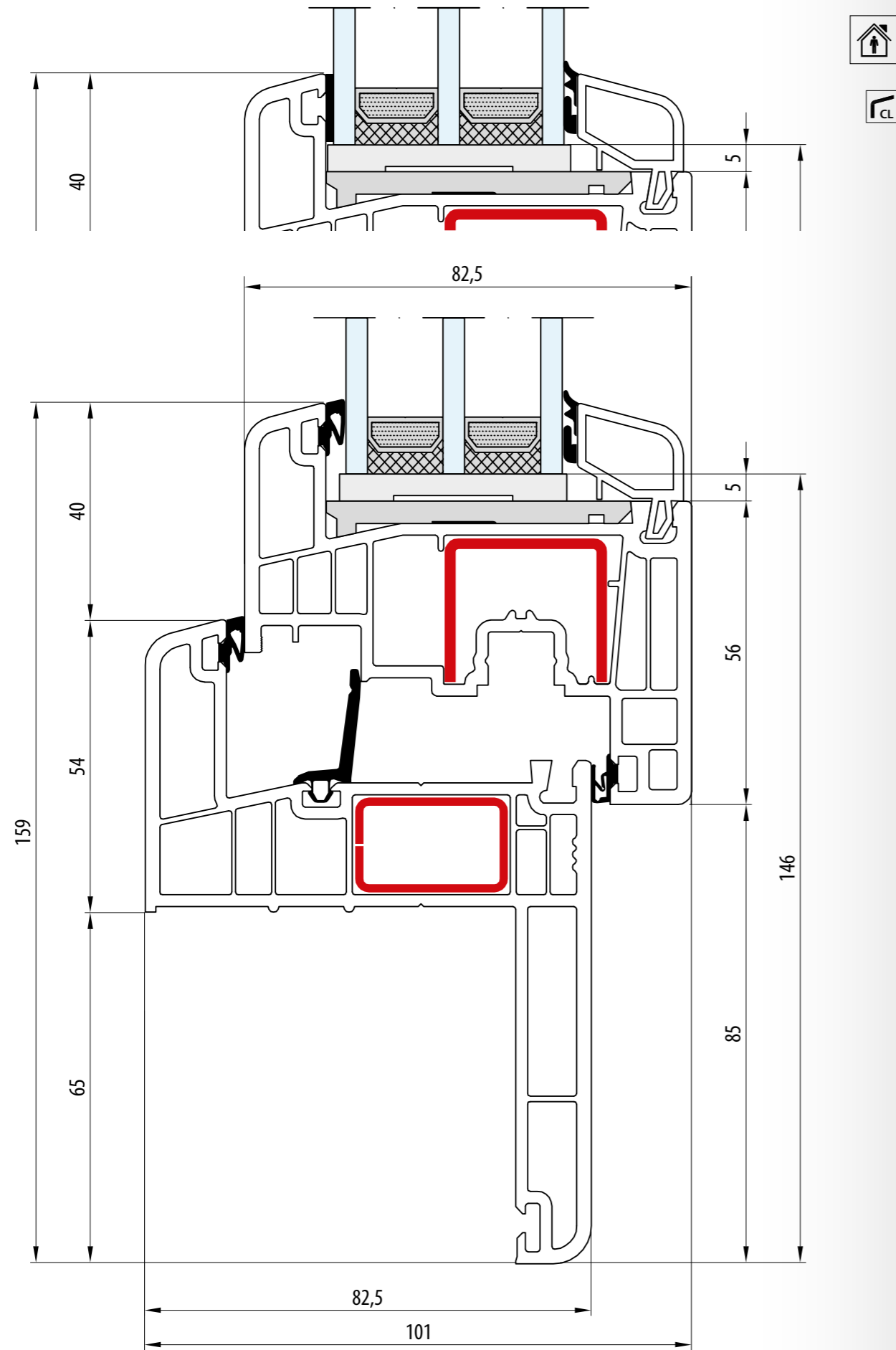

- RENOWACJA - Pletwa: 65 mm · Rama: 54 mm · Skrzydło: 74 mm
- RÉNOVATION - Lip: 65 mm · Dormant: 54 mm · Vantail: 74 mm
- RENOVATION - Strip: 65 mm · Frame: 54 mm · Sash: 74 mm
- RENOVIERUNG - Flosse: 65 mm · Rahmen: 54 mm · Flügel: 74 mm
- RINNOVAZIONE - Aletta da: 65 mm · Telaio: 54 mm · Anta: 74 mm

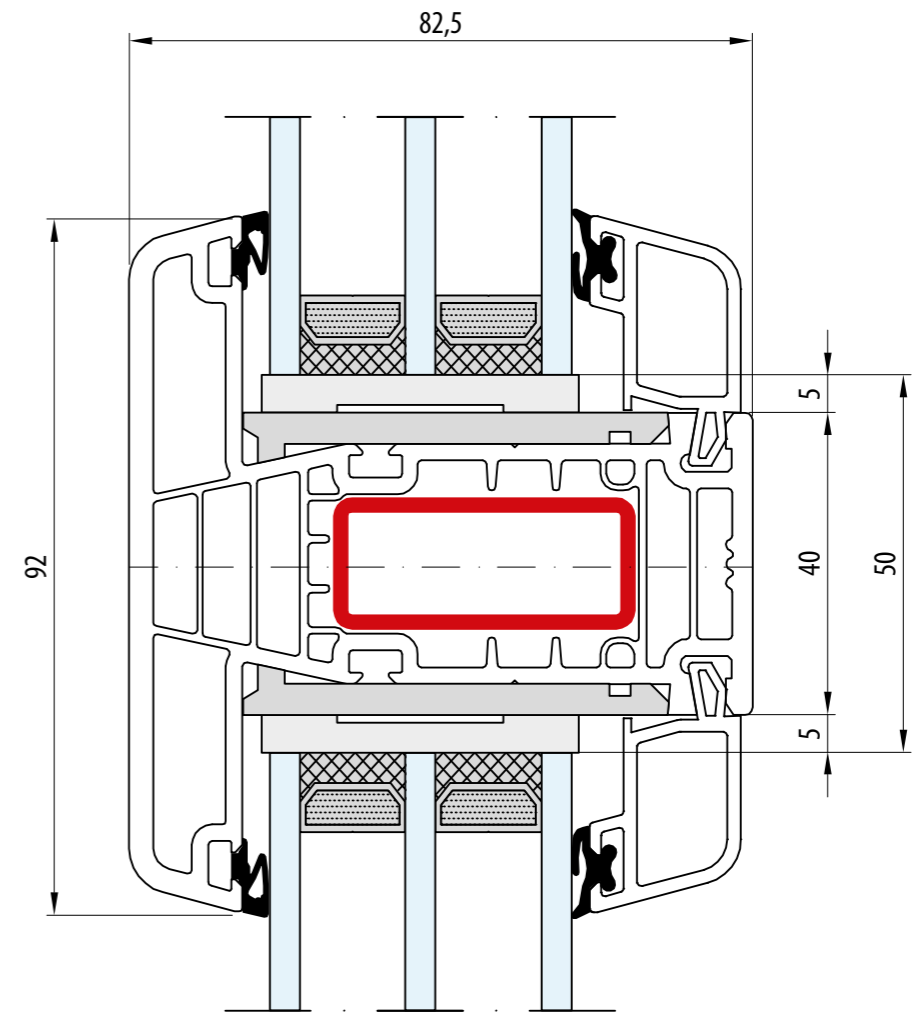
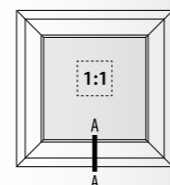

- Słupek stalowy: 92 mm
- Meneau fixe: 92 mm
- Fix post: 92 mm
- Festem Pfahl: 92 mm
- Montante fisso: 92 mm

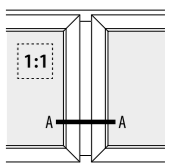



STV

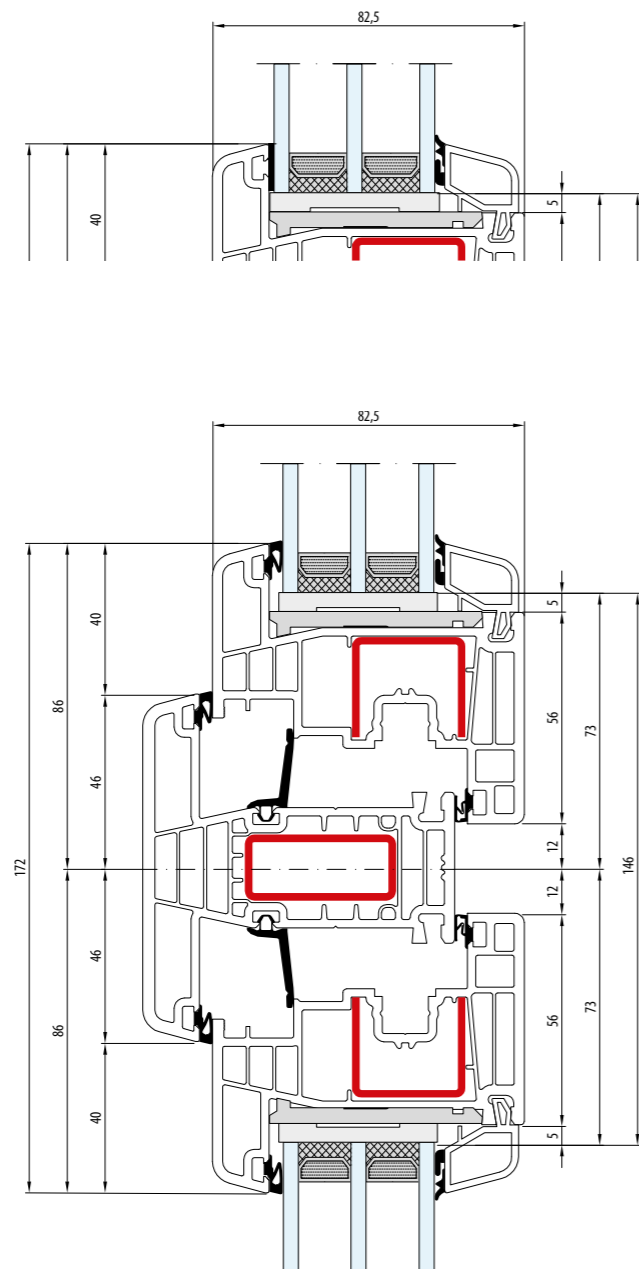

- Słupek stalowy: 92 mm · Skrzydło: 74 mm
- Meneau fixe: 92 mm · Vantail: 74 mm
- Fix post: 92 mm · Sash: 74 mm
- Festem Pfahl: 92 mm · Flügel: 74 mm
- Montante fisso: 92 mm · Anta: 74 mm

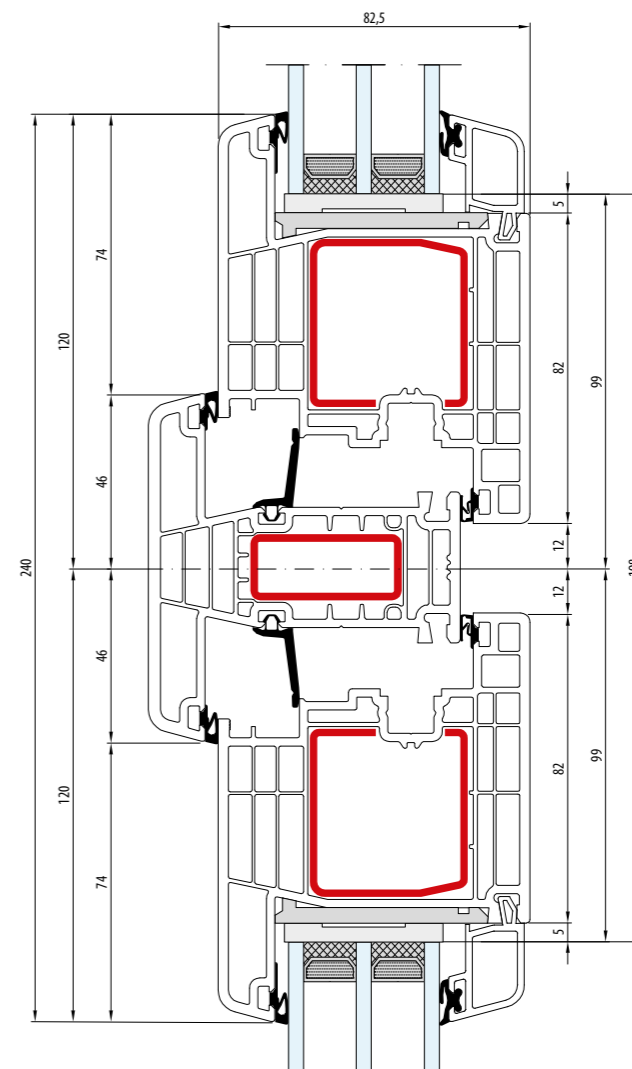
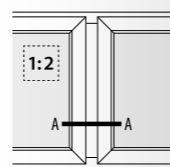

- Słupek stalowy: 92 mm · Skrzydło: 108 mm
- Meneau fixe: 92 mm · Vantail: 108 mm
- Fix post: 92 mm · Sash: 108 mm
- Festem Pfahl: 92 mm · Flügel: 108 mm
- Montante fisso: 92 mm · Anta: 108 mm

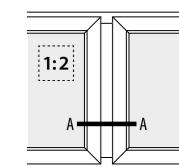

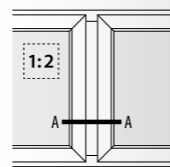
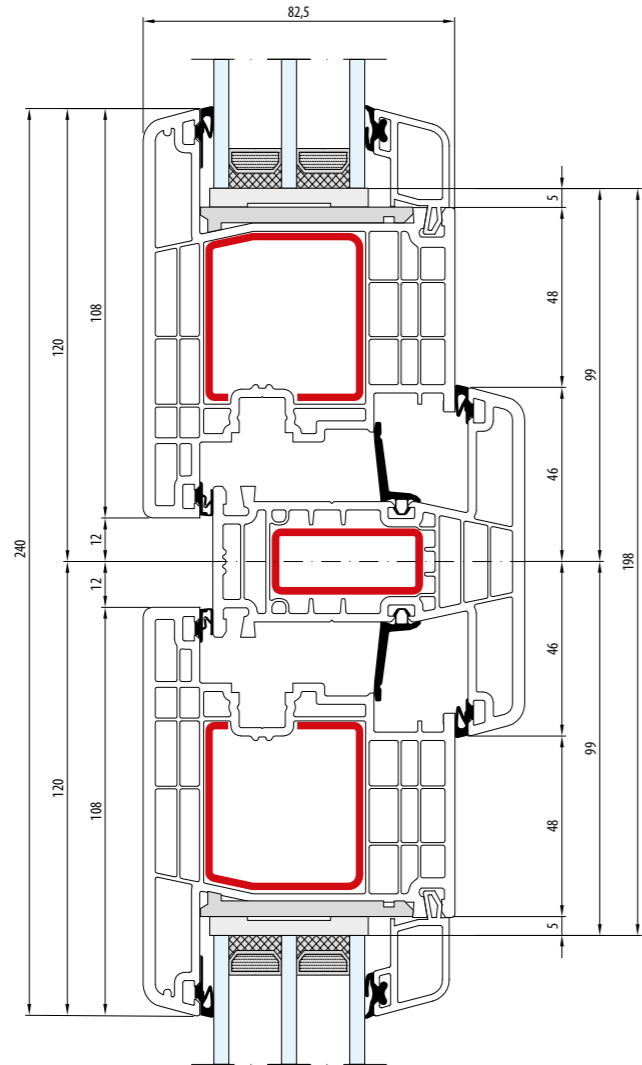

- Słupek stały: 92 mm · Skrzydło: 108 mm
- Meneau fixe: 92 mm · Vantail: 108 mm
- Fix post: 92 mm · Sash: 108 mm
- Festem Pfahl: 92 mm · Flügel: 108 mm
- Montante fisso: 92 mm · Anta: 108 mm





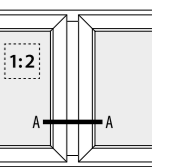
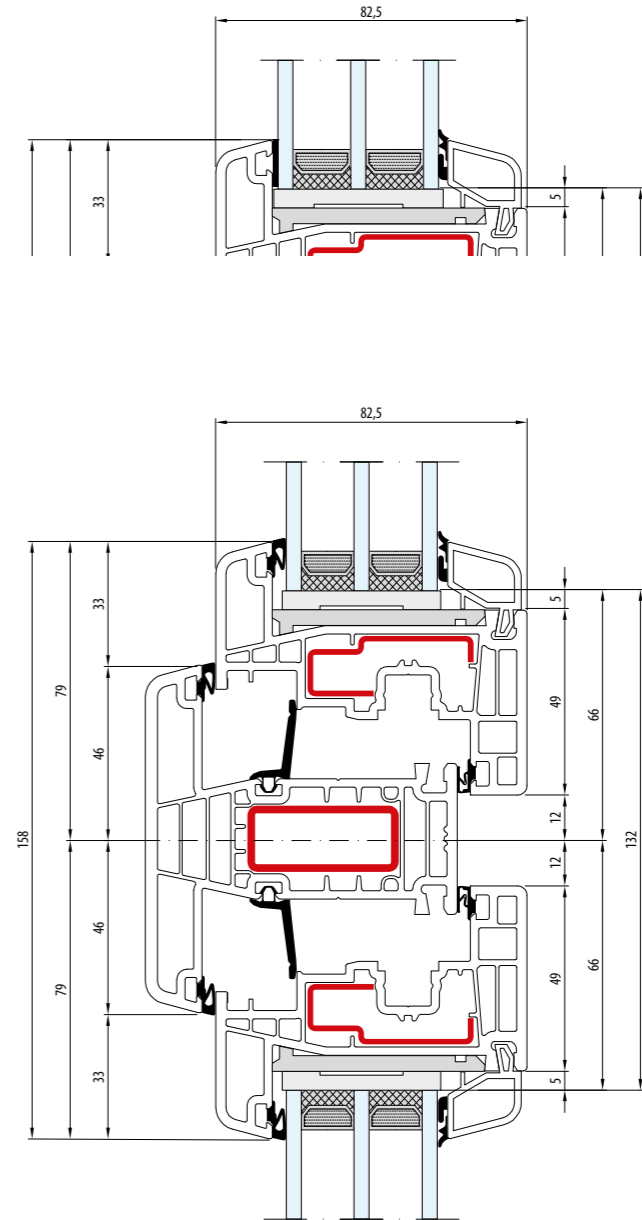



STV

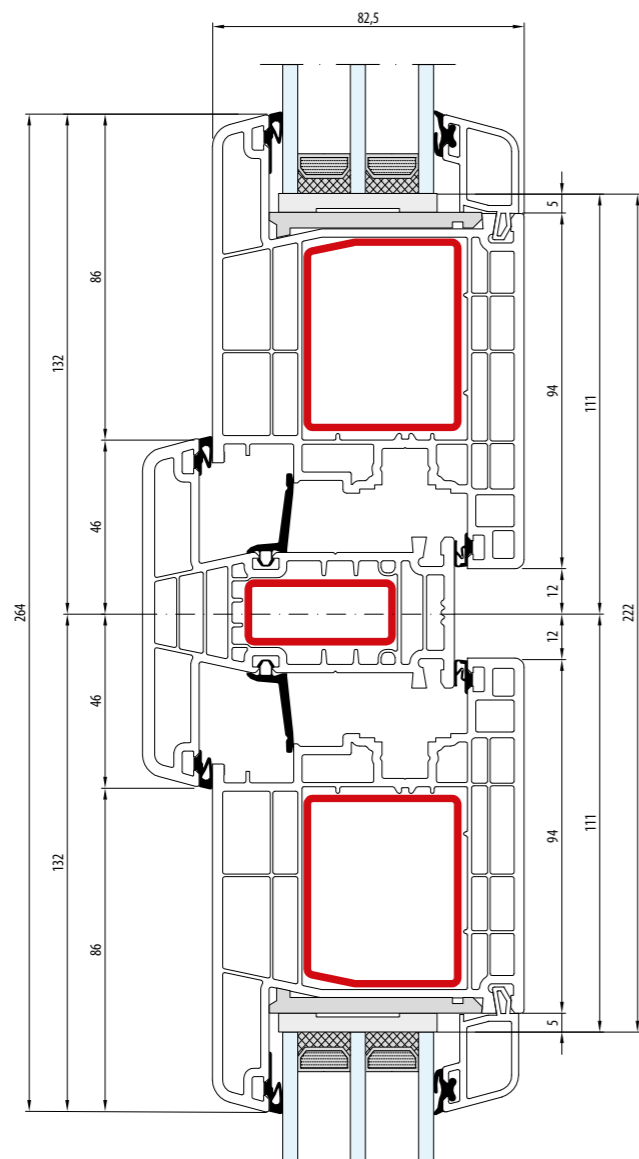

- Słupek stały: 108 mm · Skrzydło: 67 mm
- Meneau fixe: 108 mm · Vantail: 67 mm
- Fix post: 108 mm · Sash: 67 mm
- Festem Pfahl: 108 mm · Flügel: 67 mm
- Montante fisso: 108 mm · Anta: 67 mm





-  Słupek stalowy: 92 mm · Skrzydło: 120 mm
-  Meneau fixe: 92 mm · Vantail: 120 mm
-  Fix post: 92 mm · Sash: 120 mm
-  Festem Pfahl: 92 mm · Flügel: 120 mm
-  Montante fisso: 92 mm · Anta: 120 mm

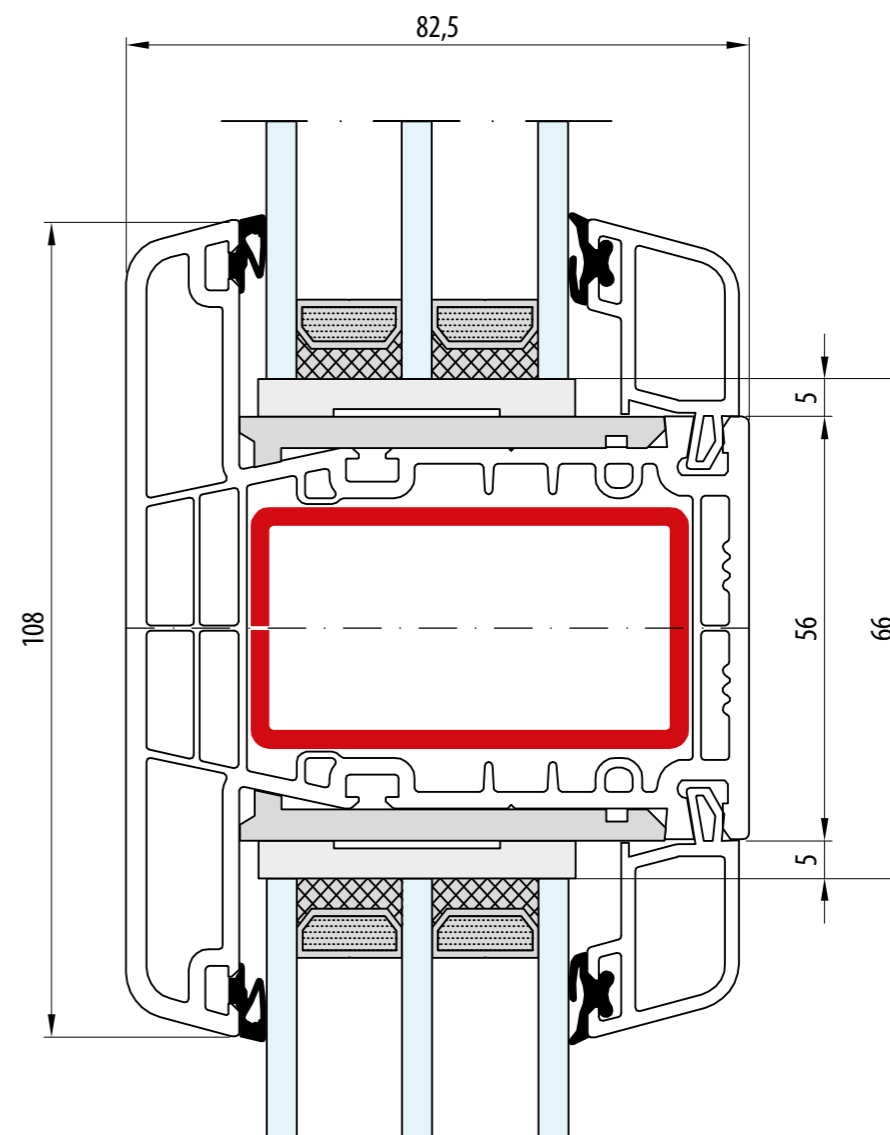
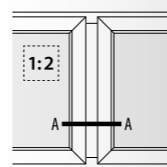

-  Słupek stalowy: 108 mm
-  Meneau fixe: 108 mm
-  Fix post: 108 mm
-  Festem Pfahl: 108 mm
-  Montante fisso: 108 mm

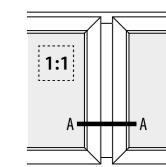



STV

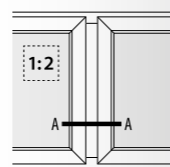
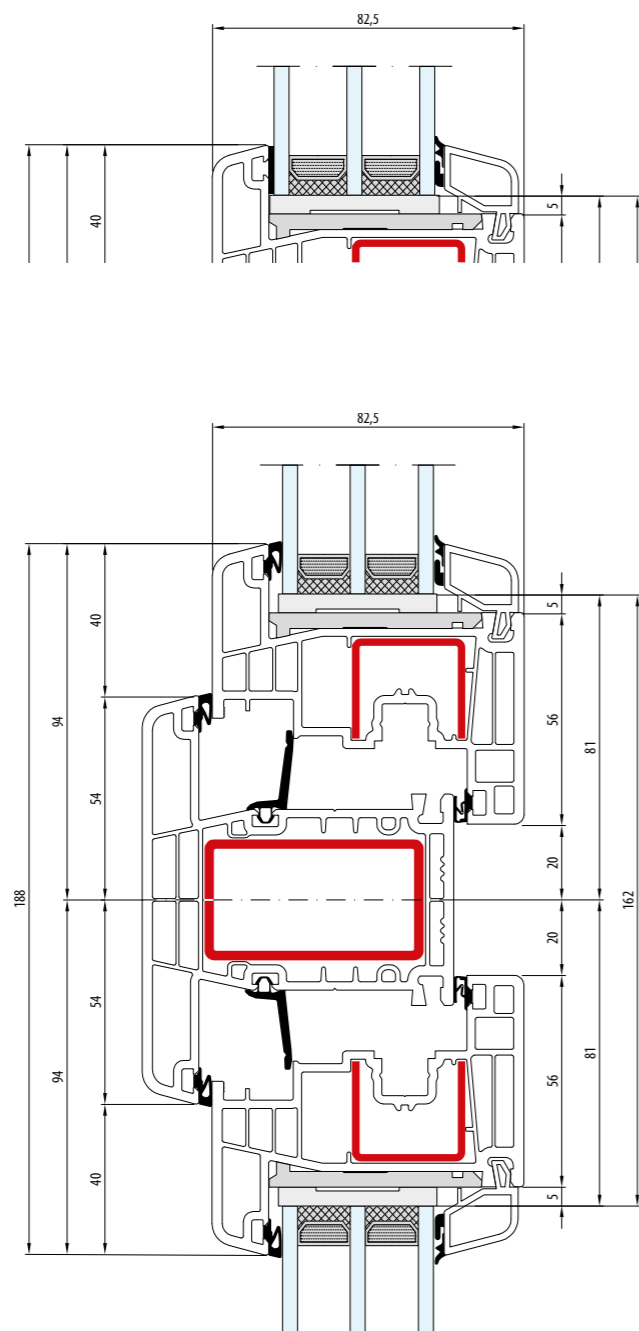

- Słupek stały: 108 mm · Skrzydło: 74 mm
- Meneau fixe: 108 mm · Vantail: 74 mm
- Fix post: 108 mm · Sash: 74 mm
- Festem Pfahl: 108 mm · Flügel: 74 mm
- Montante fisso: 108 mm · Anta: 74 mm

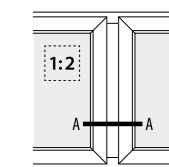
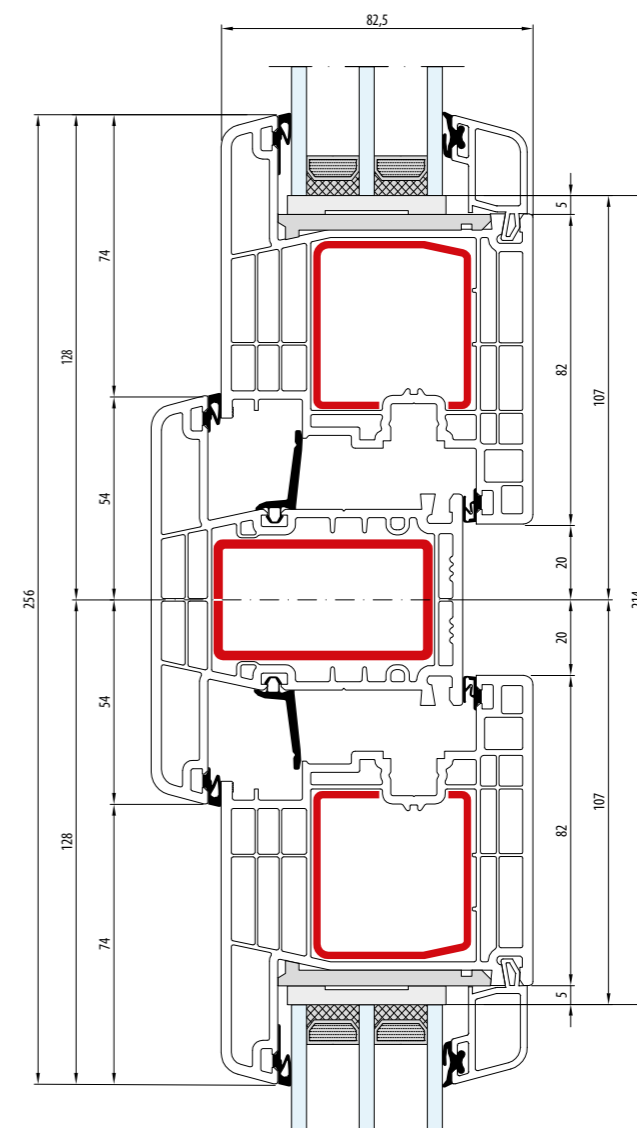

- Słupek stały: 108 mm · Skrzydło: 108 mm
- Meneau fixe: 108 mm · Vantail: 108 mm
- Fix post: 108 mm · Sash: 108 mm
- Festem Pfahl: 108 mm · Flügel: 108 mm
- Montante fisso: 108 mm · Anta: 108 mm



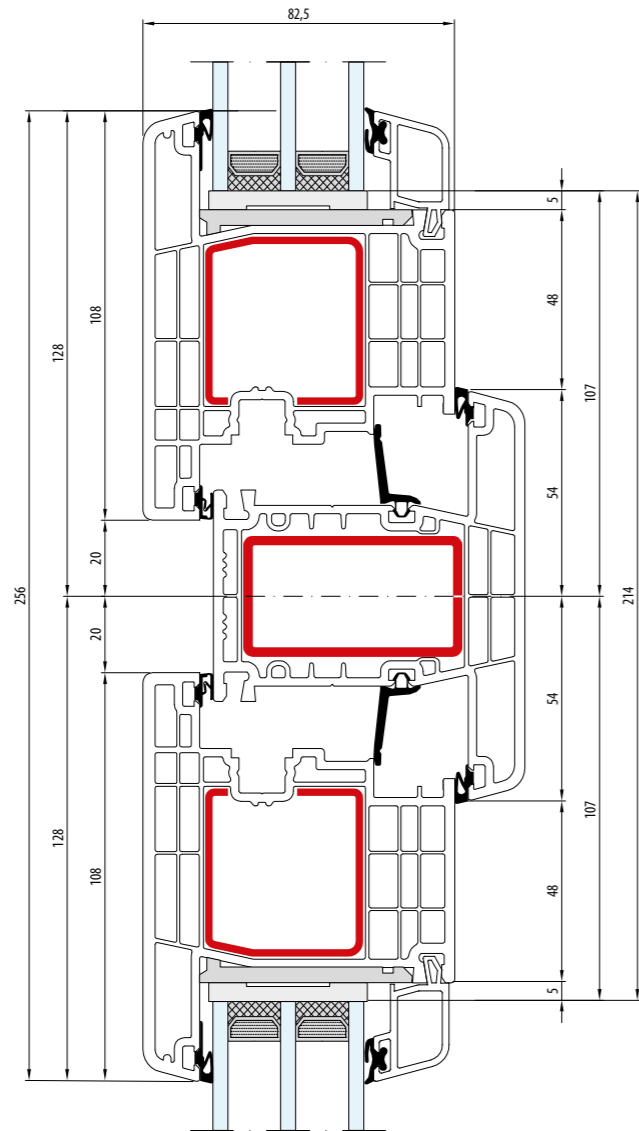

- Słupek stały: 108 mm · Skrzydło: 108 mm
- Meneau fixe: 108 mm · Vantail: 108 mm
- Fix post: 108 mm · Sash: 108 mm
- Festem Pfahl: 108 mm · Flügel: 108 mm
- Montante fisso: 108 mm · Anta: 108 mm

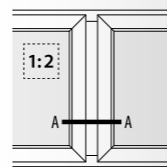

STV

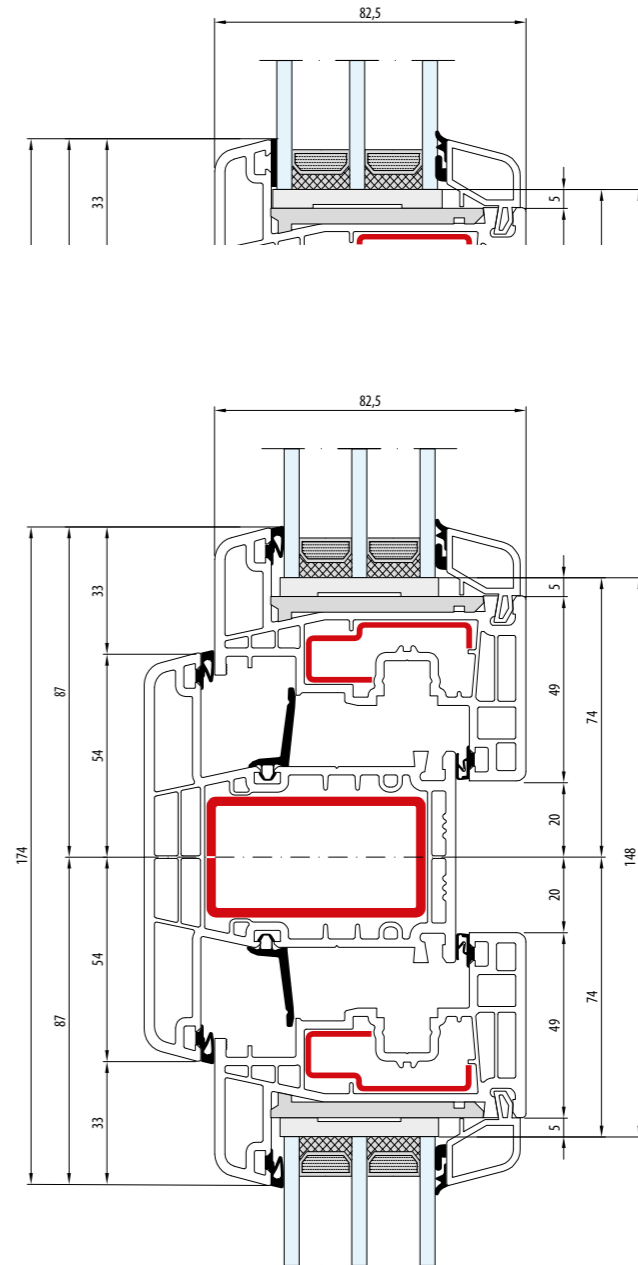

- Słupek stały: 108 mm · Skrzydło: 67 mm
- Meneau fixe: 108 mm · Vantail: 67 mm
- Fix post: 108 mm · Sash: 67 mm
- Festem Pfahl: 108 mm · Flügel: 67 mm
- Montante fisso: 108 mm · Anta: 67 mm

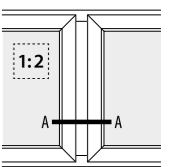

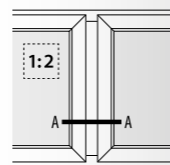
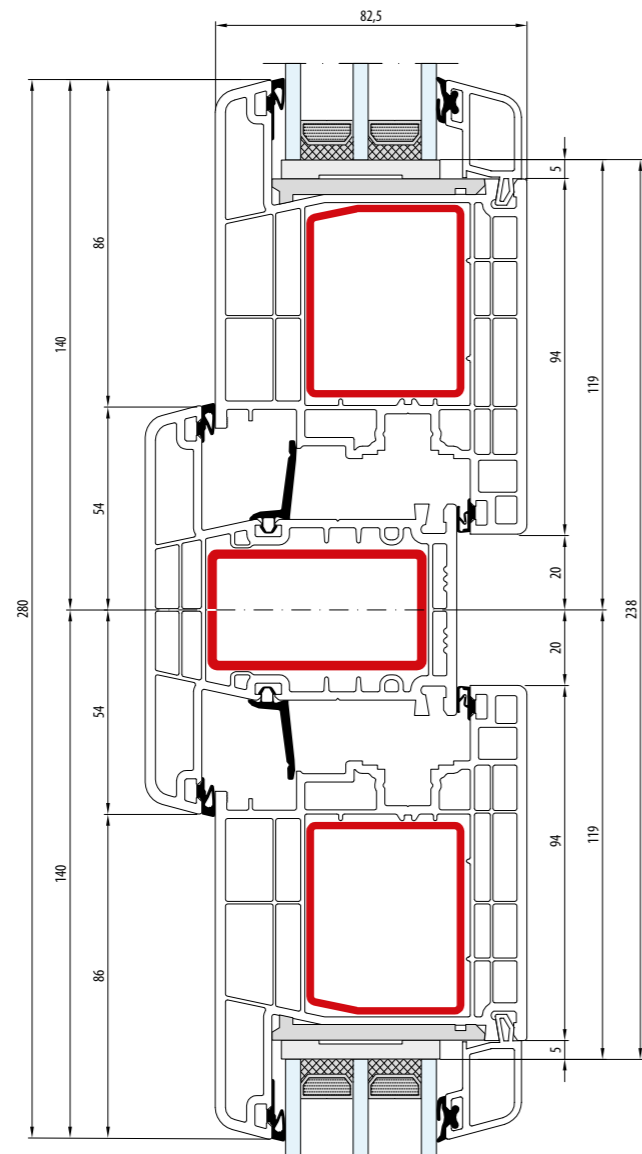

- Słupek stały: 108 mm · Skrzydło: 120 mm
- Meneau fixe: 108 mm · Vantail: 120 mm
- Fix post: 108 mm · Sash: 120 mm
- Festem Pfahl: 108 mm · Flügel: 120 mm
- Montante fisso: 108 mm · Anta: 120 mm

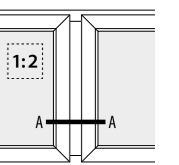
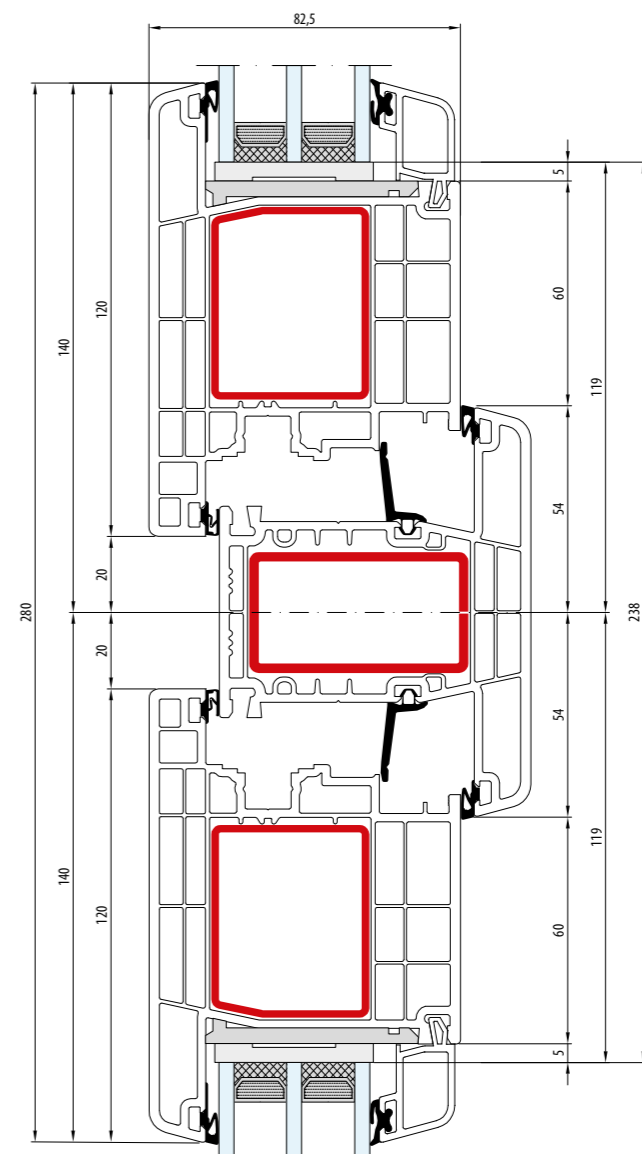

- Słupek stały: 108 mm · Skrzydło: 120 mm
- Meneau fixe: 108 mm · Vantail: 120 mm
- Fix post: 108 mm · Sash: 120 mm
- Festem Pfahl: 108 mm · Flügel: 120 mm
- Montante fisso: 108 mm · Anta: 120 mm





STV

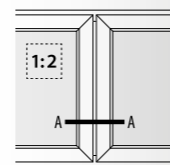
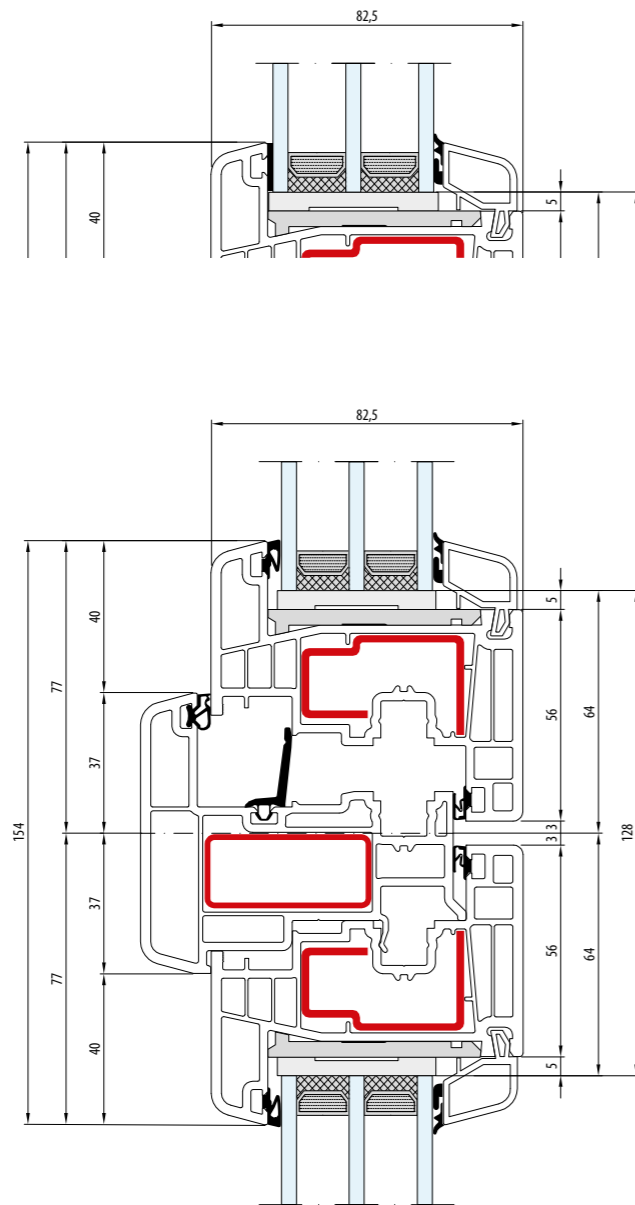

- Słupek ruchomy: 74 mm · Skrzydło: 74 mm
- Meneau mobile: 74 mm · Vantail: 74 mm
- Movable post: 74 mm · Sash: 74 mm
- Stulp: 74 mm · Flügel: 74 mm
- Montante mobile: 74 mm · Anta: 74 mm

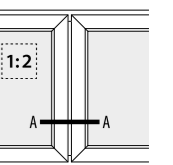
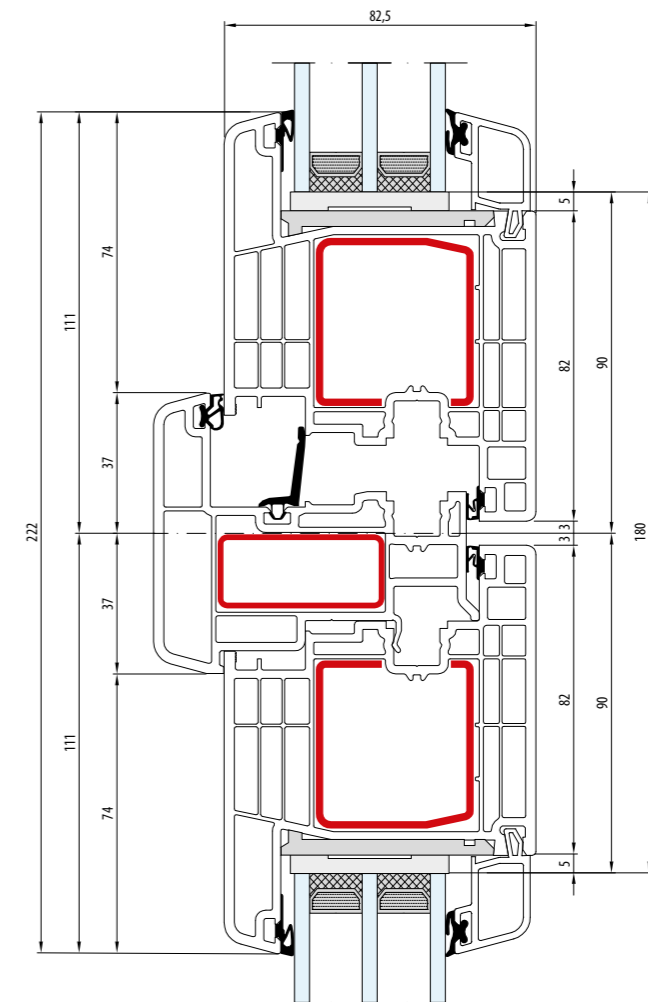

- Słupek ruchomy: 74 mm · Skrzydło: 108 mm
- Meneau mobile: 74 mm · Vantail: 108 mm
- Movable post: 74 mm · Sash: 108 mm
- Stulp: 74 mm · Flügel: 108 mm
- Montante mobile: 74 mm · Anta: 108 mm

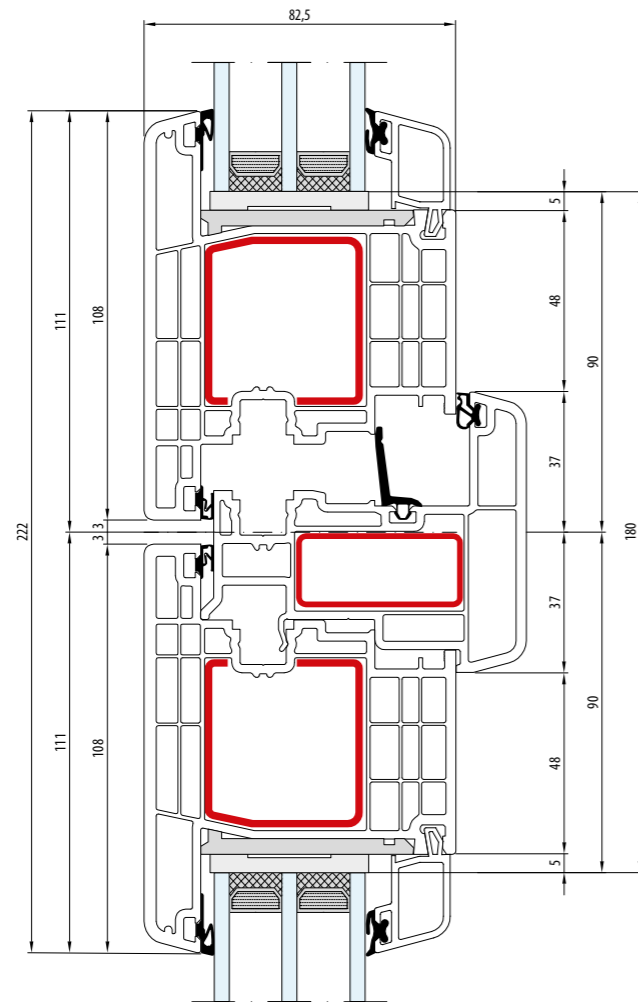

- Słupek ruchomy: 74 mm · Skrzydło: 108 mm
- Meneau mobile: 74 mm · Vantail: 108 mm
- Movable post: 74 mm · Sash: 108 mm
- Stulp: 74 mm · Flügel: 108 mm
- Montante mobile: 74 mm · Anta: 108 mm

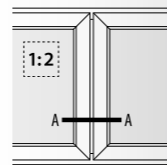



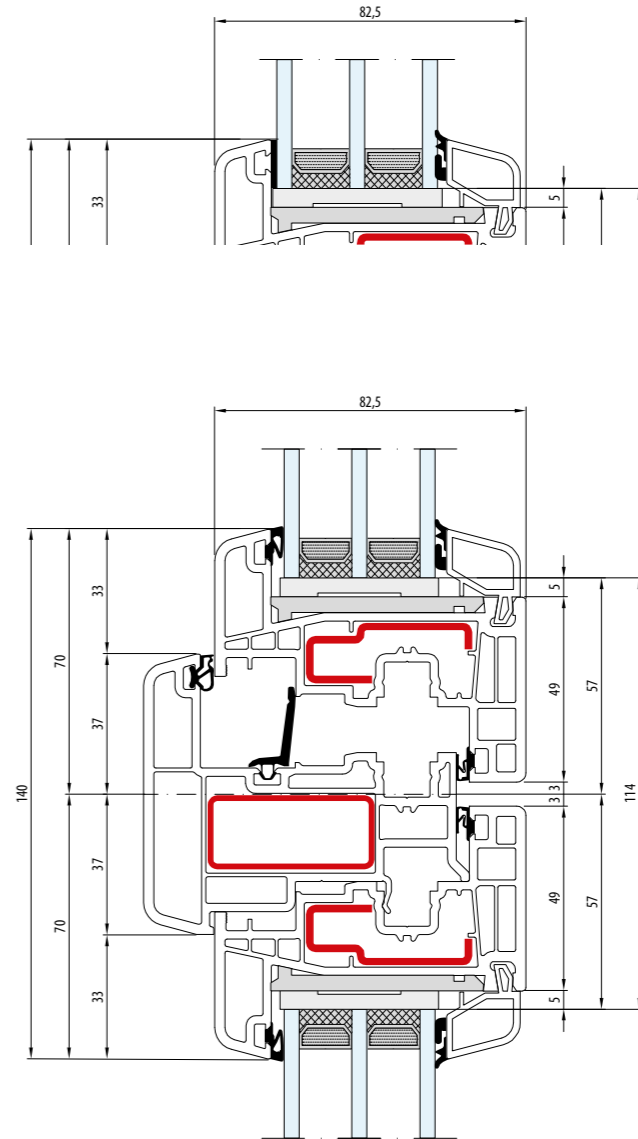

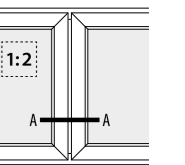

STV

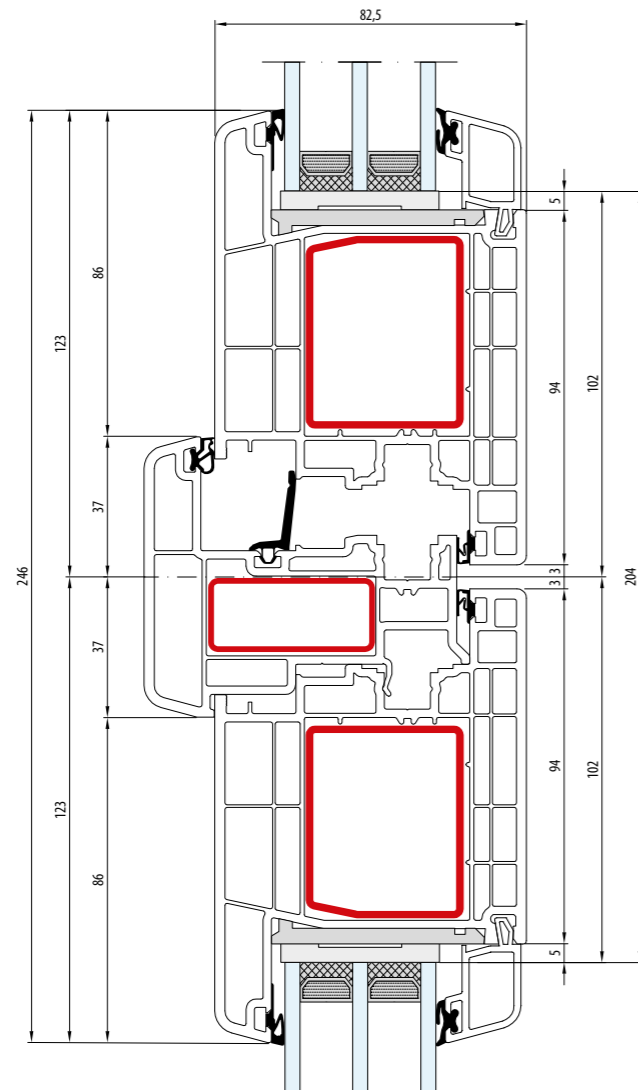







- Słupek ruchomy: 74 mm · Skrzydło: 67 mm
- Meneau mobile: 74 mm · Vantail: 67 mm
- Movable post: 74 mm · Sash: 67 mm
- Stulp: 74 mm · Flügel: 67 mm
- Montante mobile: 74 mm · Anta: 67 mm

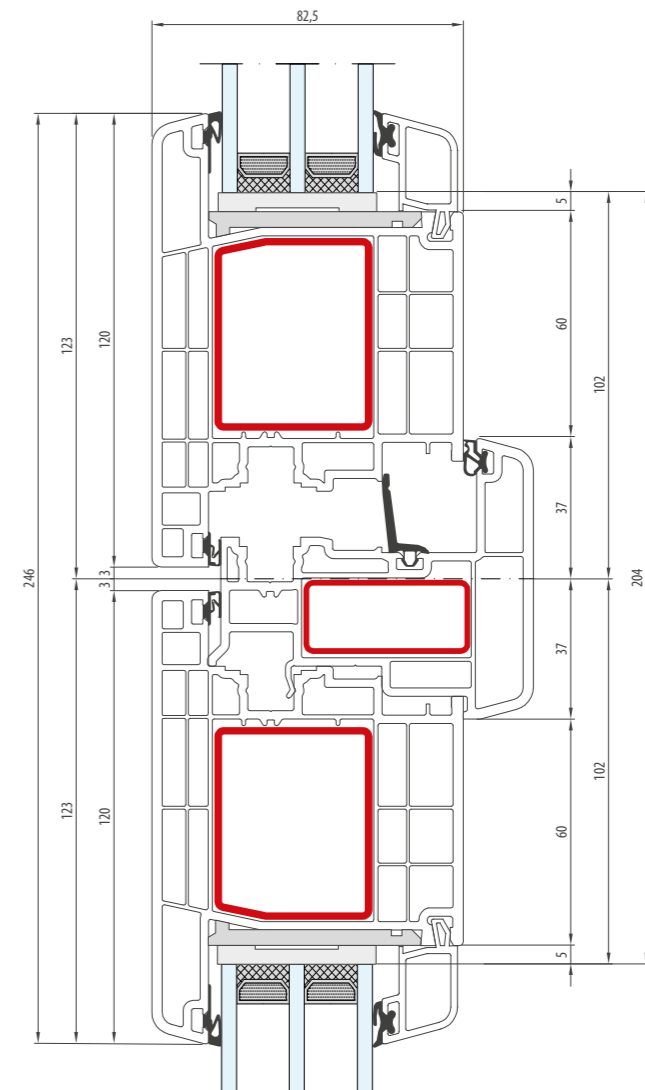
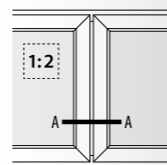



-  Słupek ruchomy: 74 mm · Skrzydło: 120 mm
-  Meneau mobile: 74 mm · Vantail: 120 mm
-  Movable post: 74 mm · Sash: 120 mm
-  Stulp: 74 mm · Flügel: 120 mm
-  Montante mobile: 74 mm · Anta: 120 mm



-  Słupek ruchomy: 74 mm · Skrzydło: 120 mm
-  Meneau mobile: 74 mm · Vantail: 120 mm
-  Movable post: 74 mm · Sash: 120 mm
-  Stulp: 74 mm · Flügel: 120 mm
-  Montante mobile: 74 mm · Anta: 120 mm

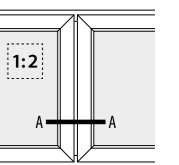



STV

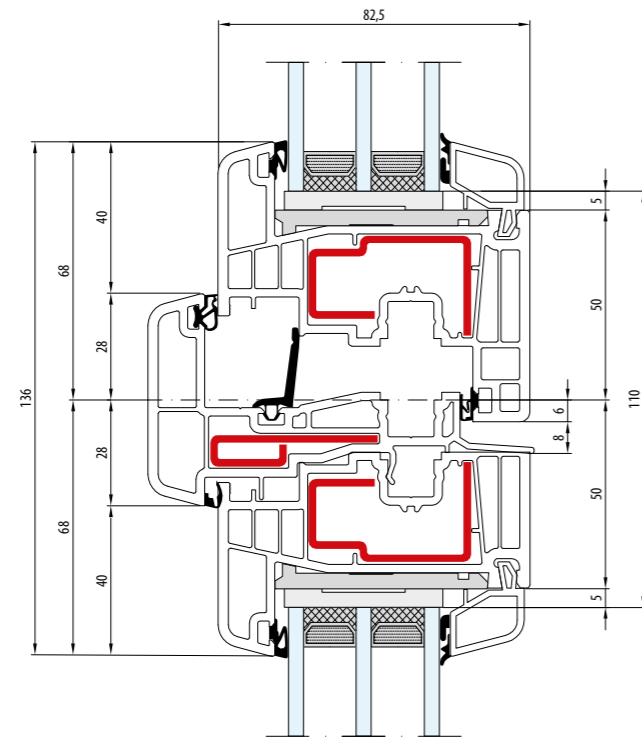
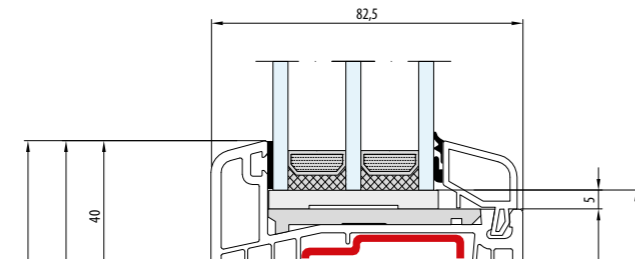

- Słupek ruchomy: 56 mm · Skrzydło: 74 mm / 54 mm
- Meneau mobile: 56 mm · Vantail: 74 mm / 54 mm
- Movable post: 56 mm · Sash: 74 mm / 54 mm
- Stulp: 56 mm · Flügel: 74 mm / 54 mm
- Montante mobile: 56 mm · Anta: 74 mm / 54 mm

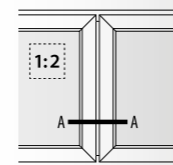

STV

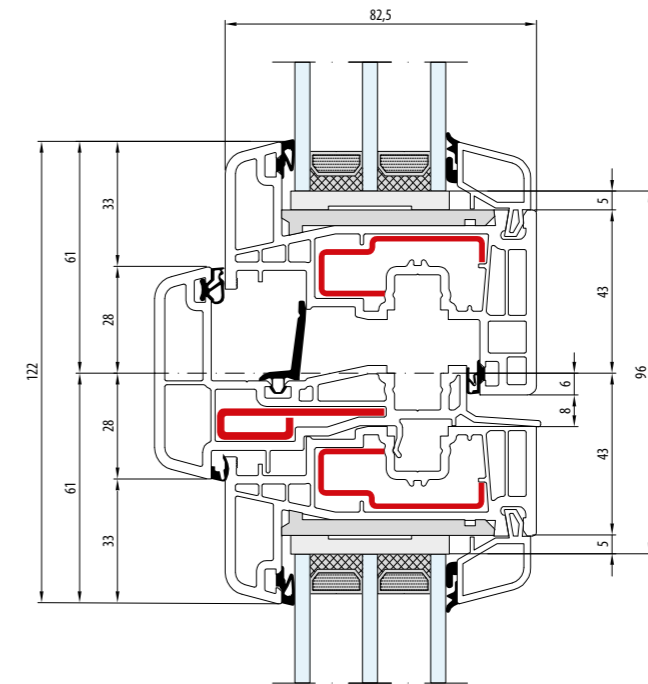
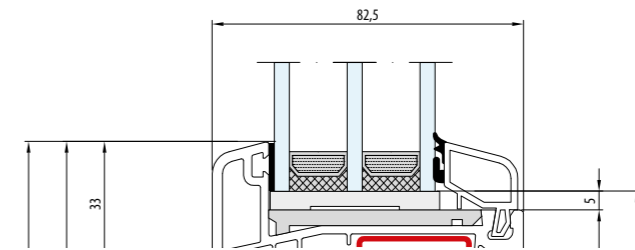

- Słupek ruchomy: 56 mm · Skrzydło: 67 mm / 47 mm
- Meneau mobile: 56 mm · Vantail: 67 mm / 47 mm
- Movable post: 56 mm · Sash: 67 mm / 47 mm
- Stulp: 56 mm · Flügel: 67 mm / 47 mm
- Montante mobile: 56 mm · Anta: 67 mm / 47 mm

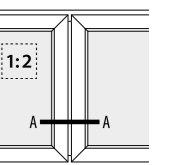

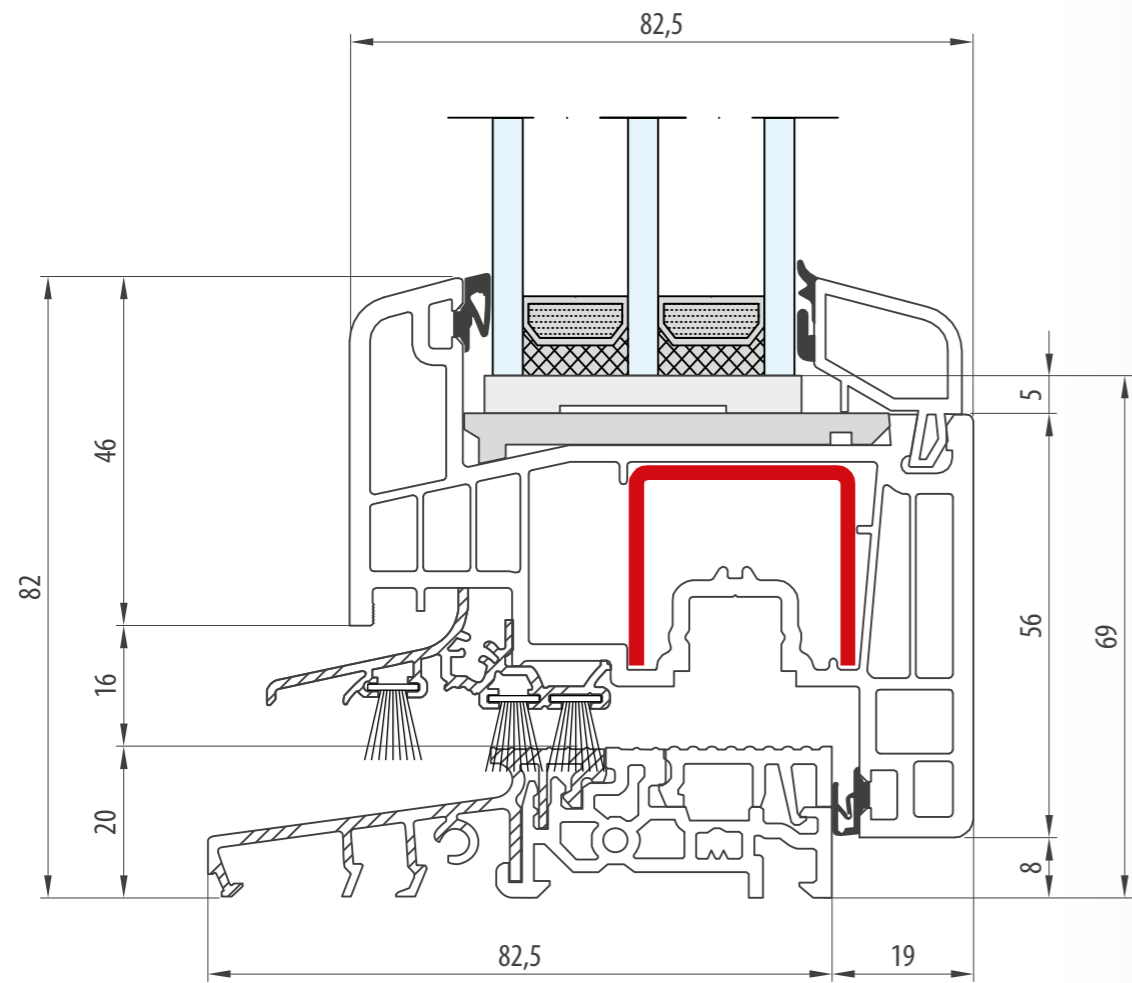

- Próg: 20 mm · Skrzydło: 74 mm
- Seuil: 20 mm · Vantail: 74 mm
- Threshold: 20 mm · Sash: 74 mm
- Schwelle: 20 mm · Flügel: 74 mm
- Soglia: 20 mm · Anta: 74 mm

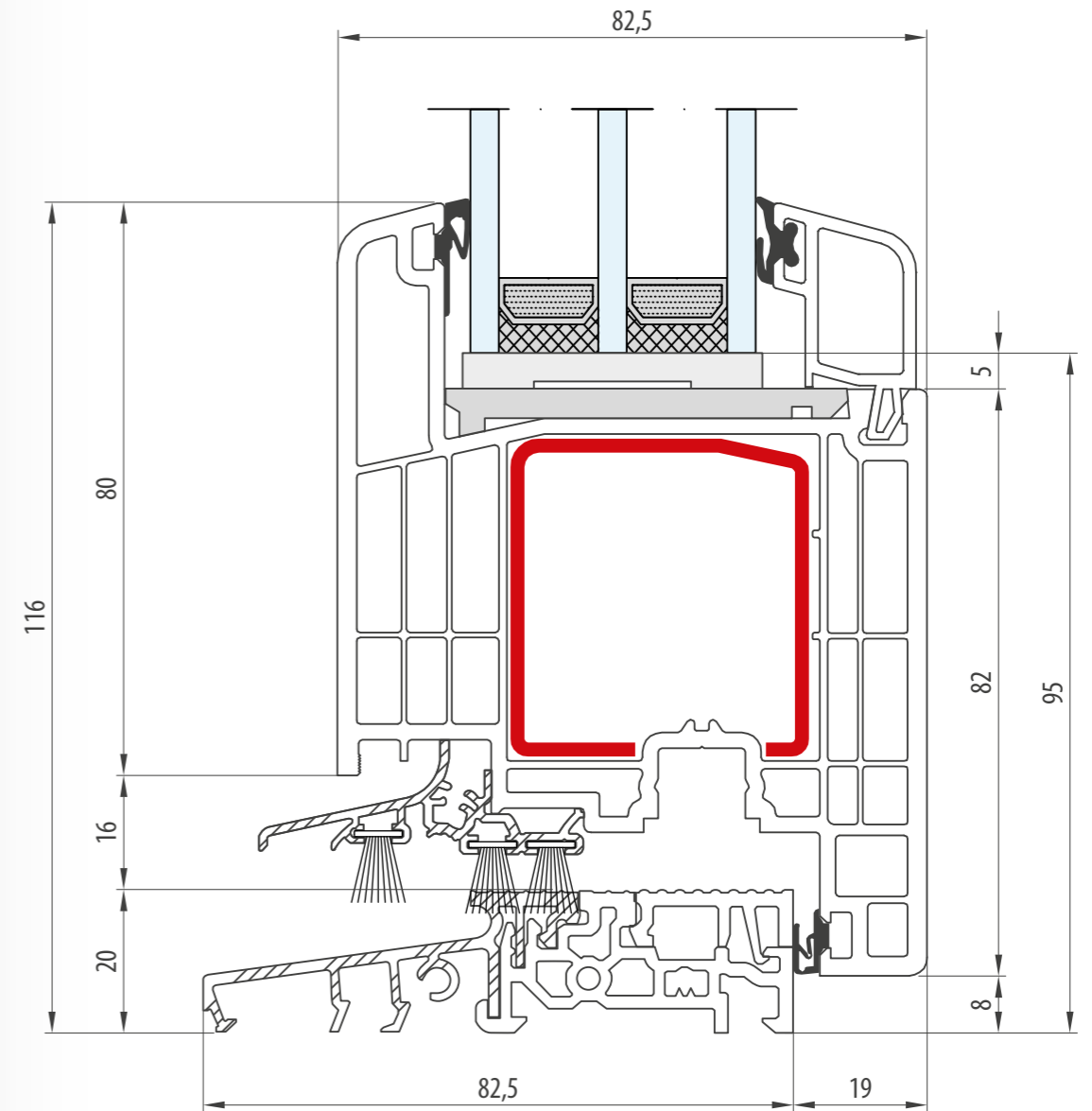
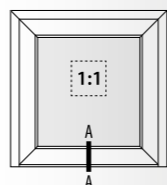

- Próg: 20 mm · Skrzydło: 108 mm
- Seuil: 20 mm · Vantail: 108 mm
- Threshold: 20 mm · Sash: 108 mm
- Schwelle: 20 mm · Flügel: 108 mm
- Soglia: 20 mm · Anta: 108 mm

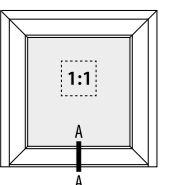

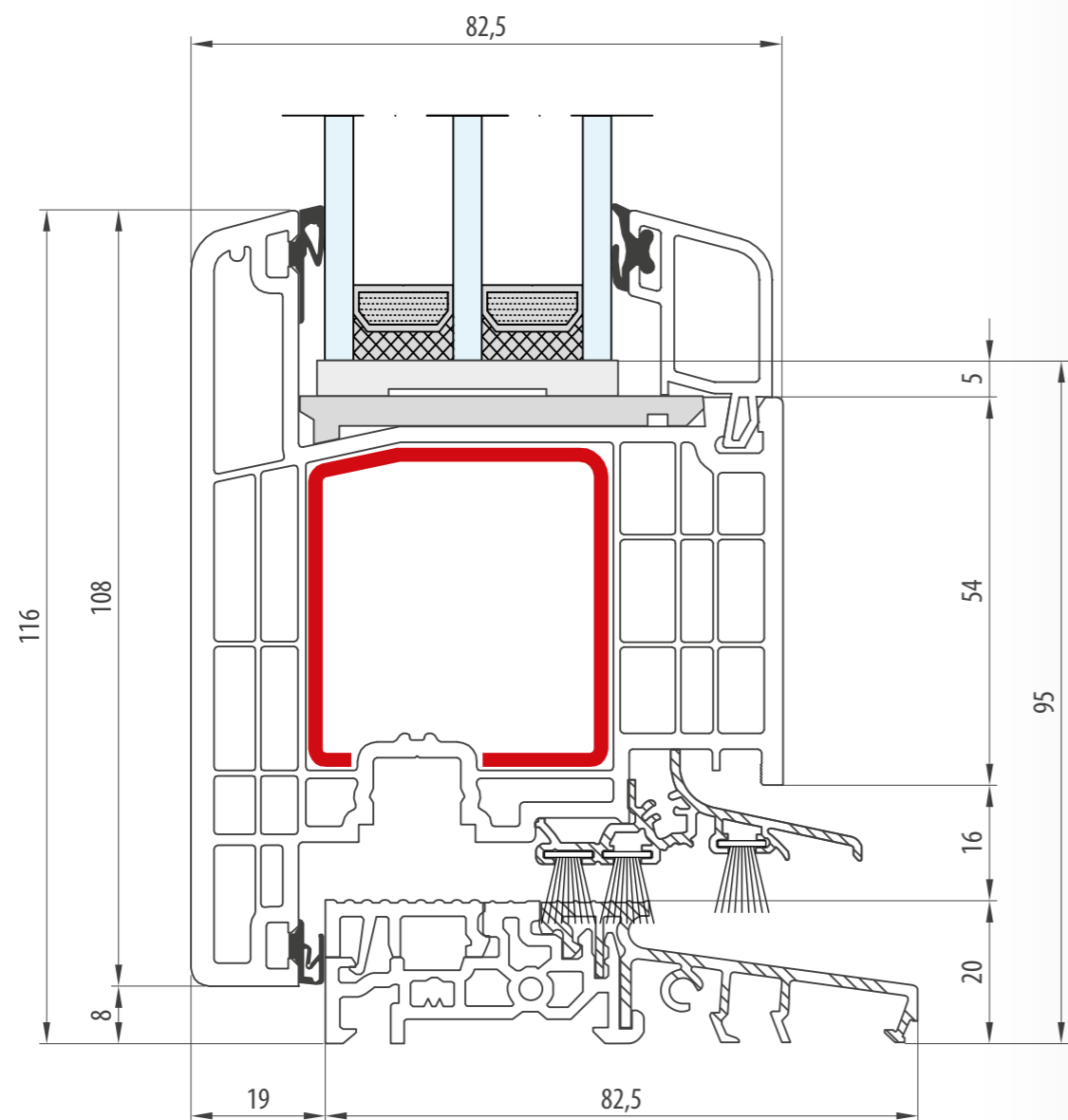

- Próg: 20 mm · Skrzydło: 108 mm
- Seuil: 20 mm · Vantail: 108 mm
- Threshold: 20 mm · Sash: 108 mm
- Schwelle: 20 mm · Flügel: 108 mm
- Soglia: 20 mm · Anta: 108 mm

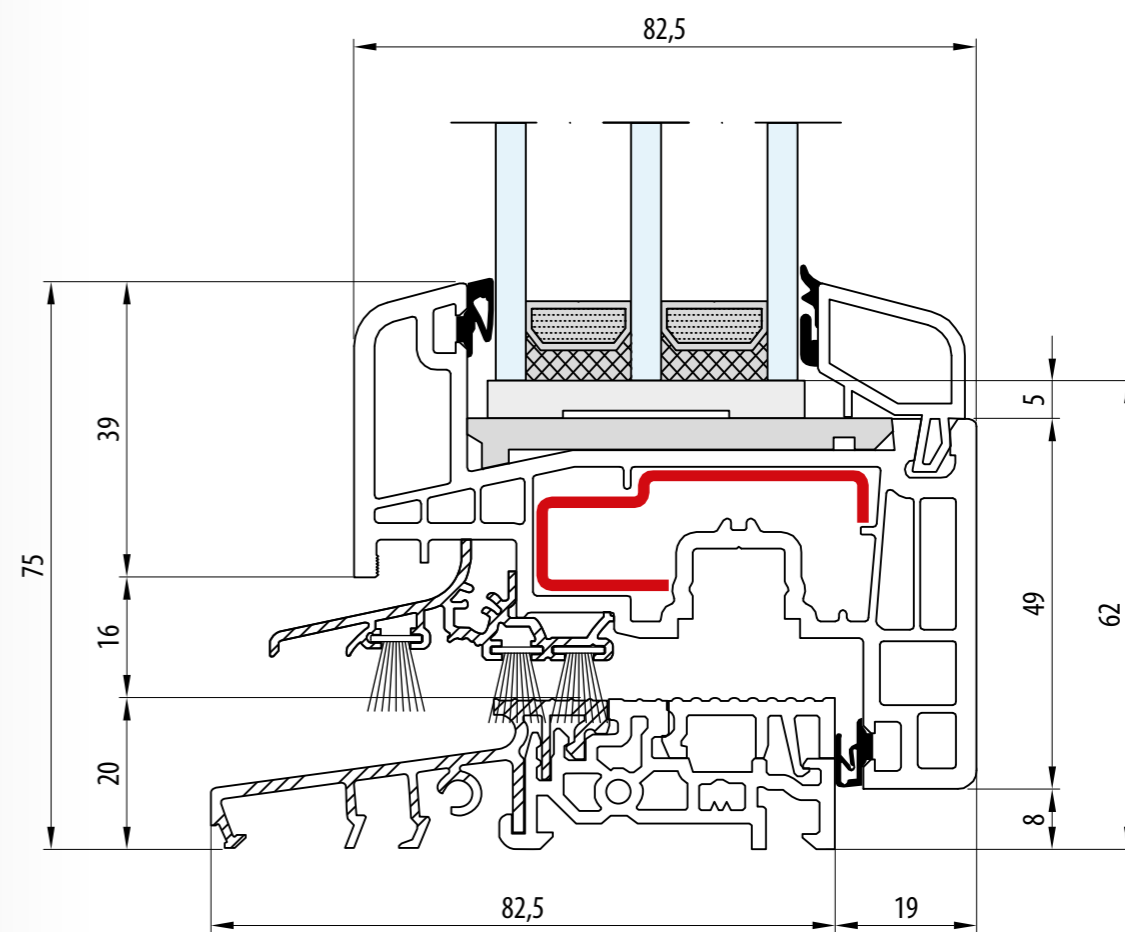
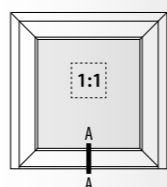

- Próg: 20 mm · Skrzydło: 67 mm
- Seuil: 20 mm · Vantail: 67 mm
- Threshold: 20 mm · Sash: 67 mm
- Schwelle: 20 mm · Flügel: 67 mm
- Soglia: 20 mm · Anta: 67 mm

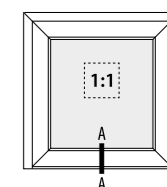

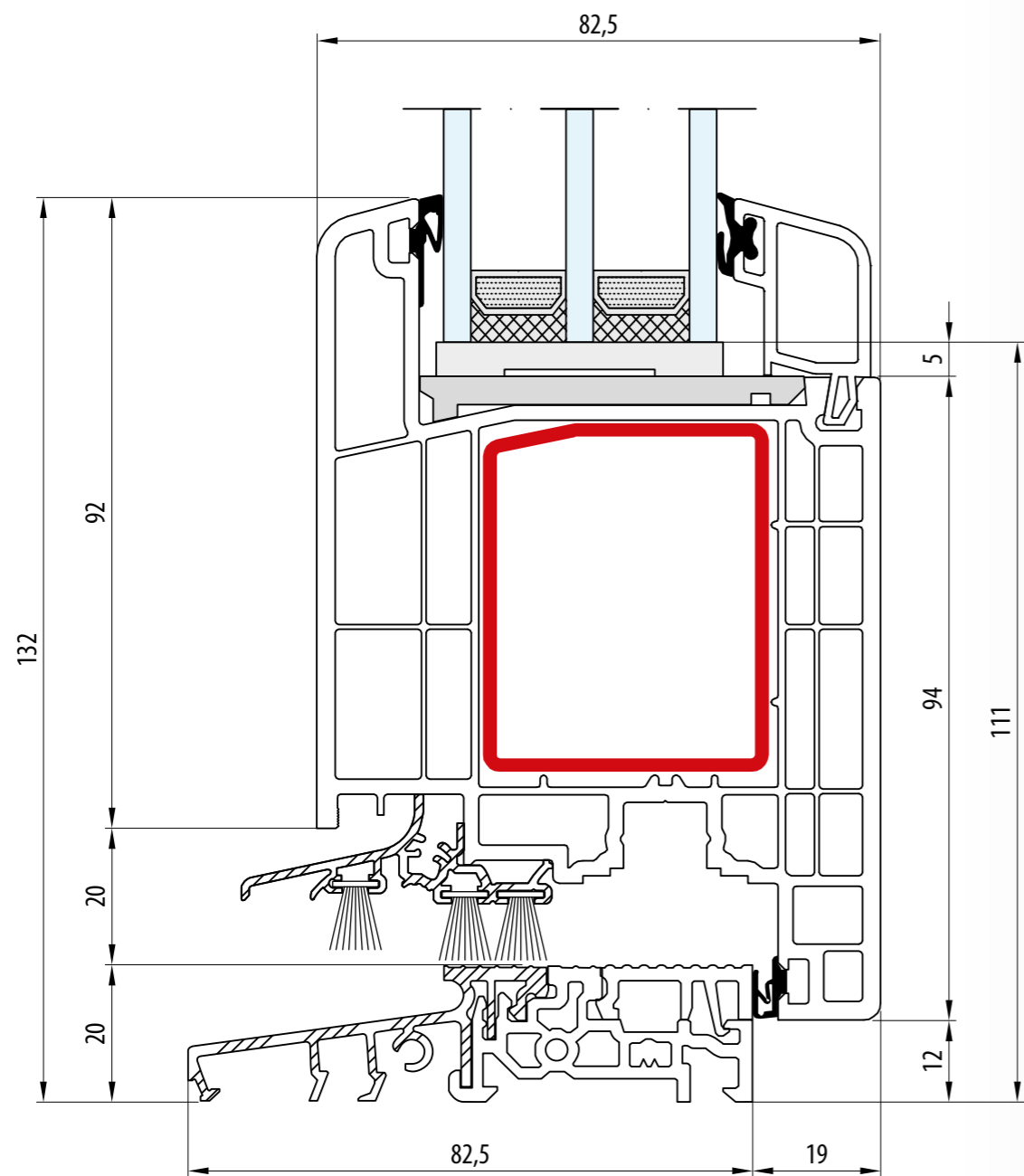

- Próg: 20 mm · Skrzydło: 120 mm
- Seuil: 20 mm · Vantail: 120 mm
- Threshold: 20 mm · Sash: 120 mm
- Schwelle: 20 mm · Flügel: 120 mm
- Soglia: 20 mm · Anta: 120 mm

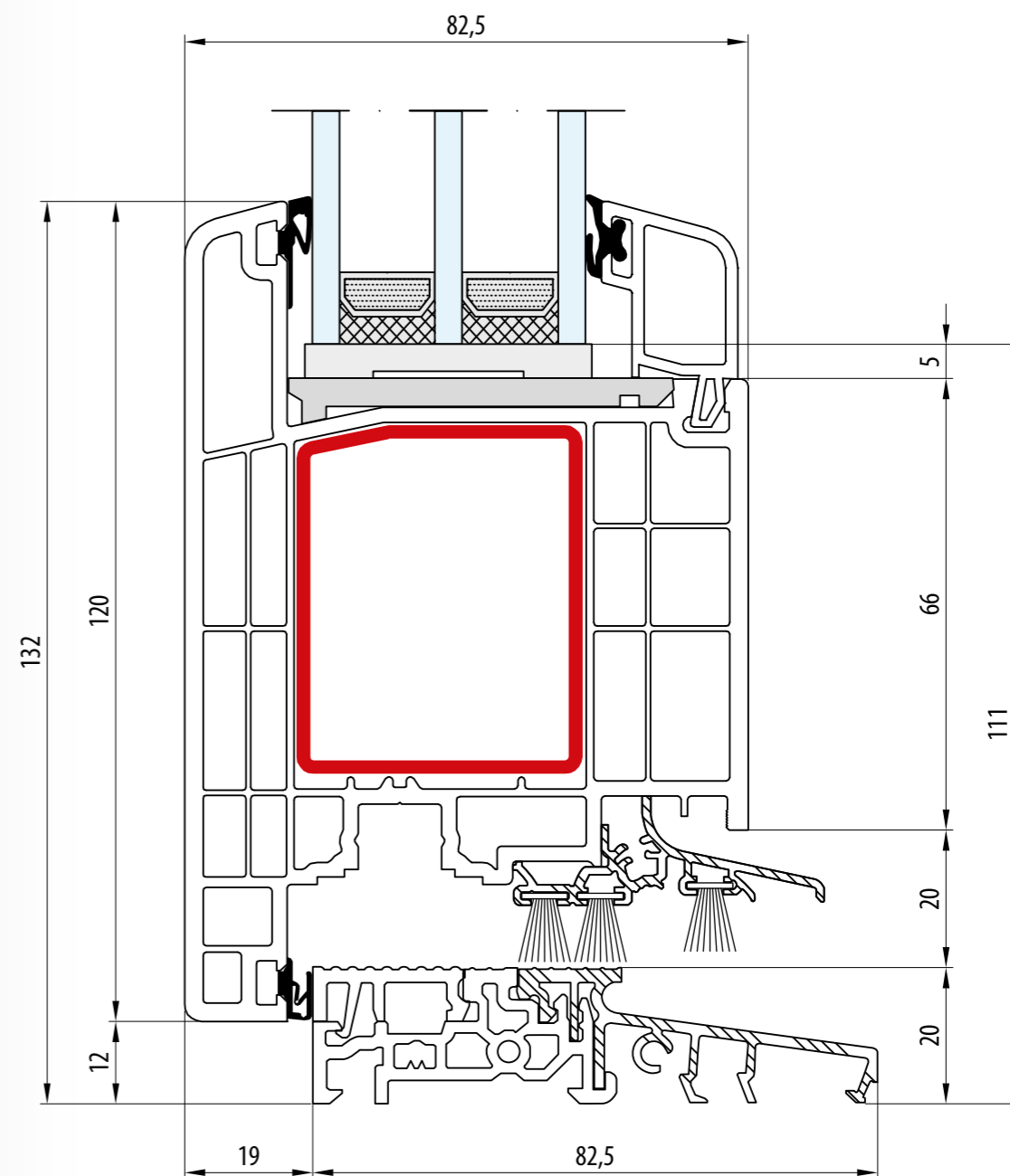
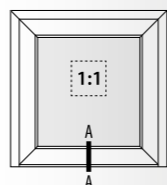

- Próg: 20 mm · Skrzydło: 120 mm
- Seuil: 20 mm · Vantail: 120 mm
- Threshold: 20 mm · Sash: 120 mm
- Schwelle: 20 mm · Flügel: 120 mm
- Soglia: 20 mm · Anta: 120 mm

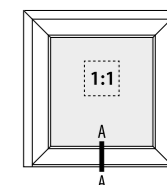

HST GEALAN

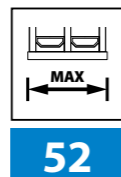
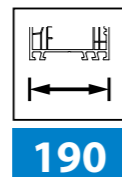
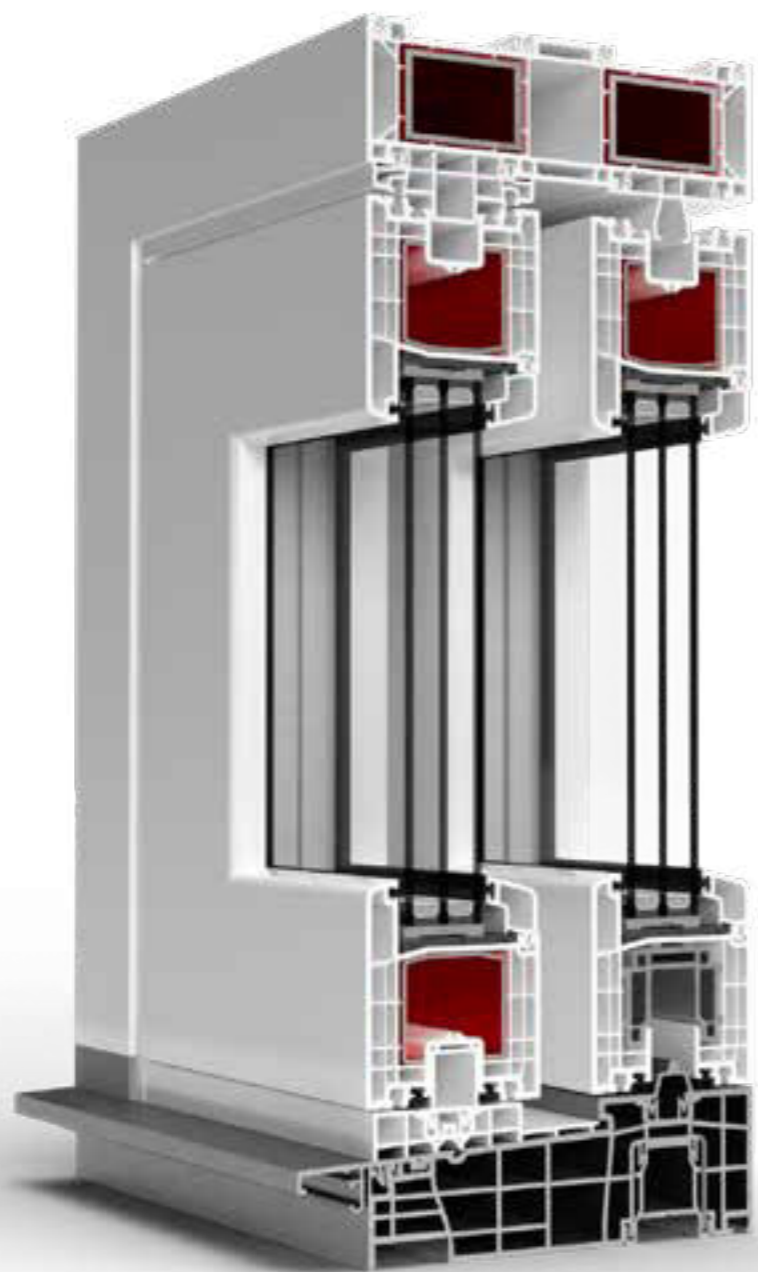

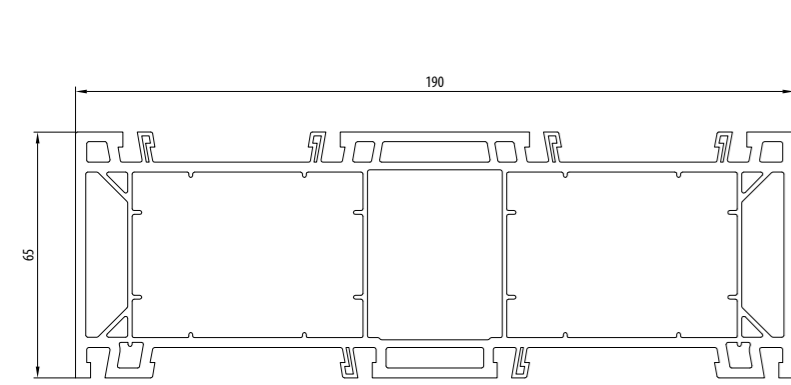

6362

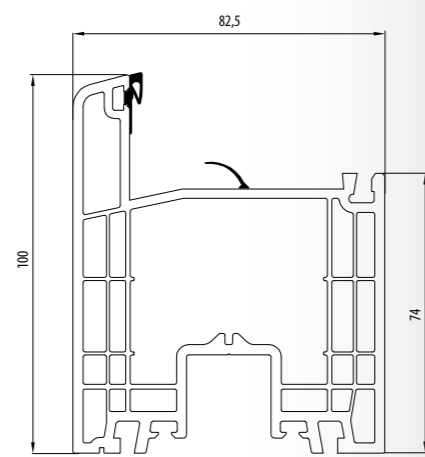

6360

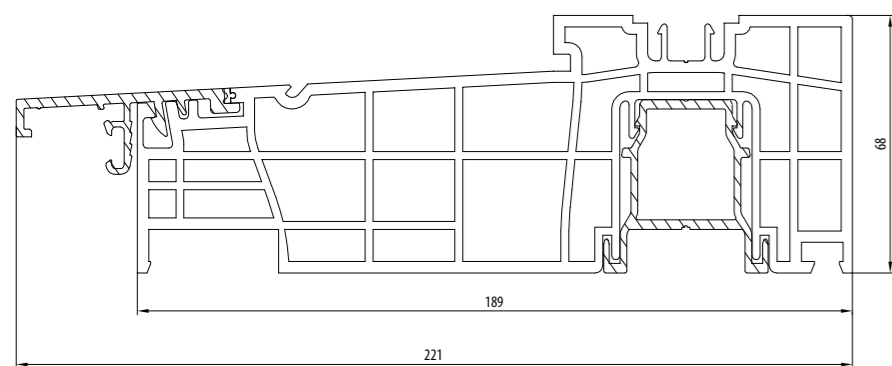

Thermostep

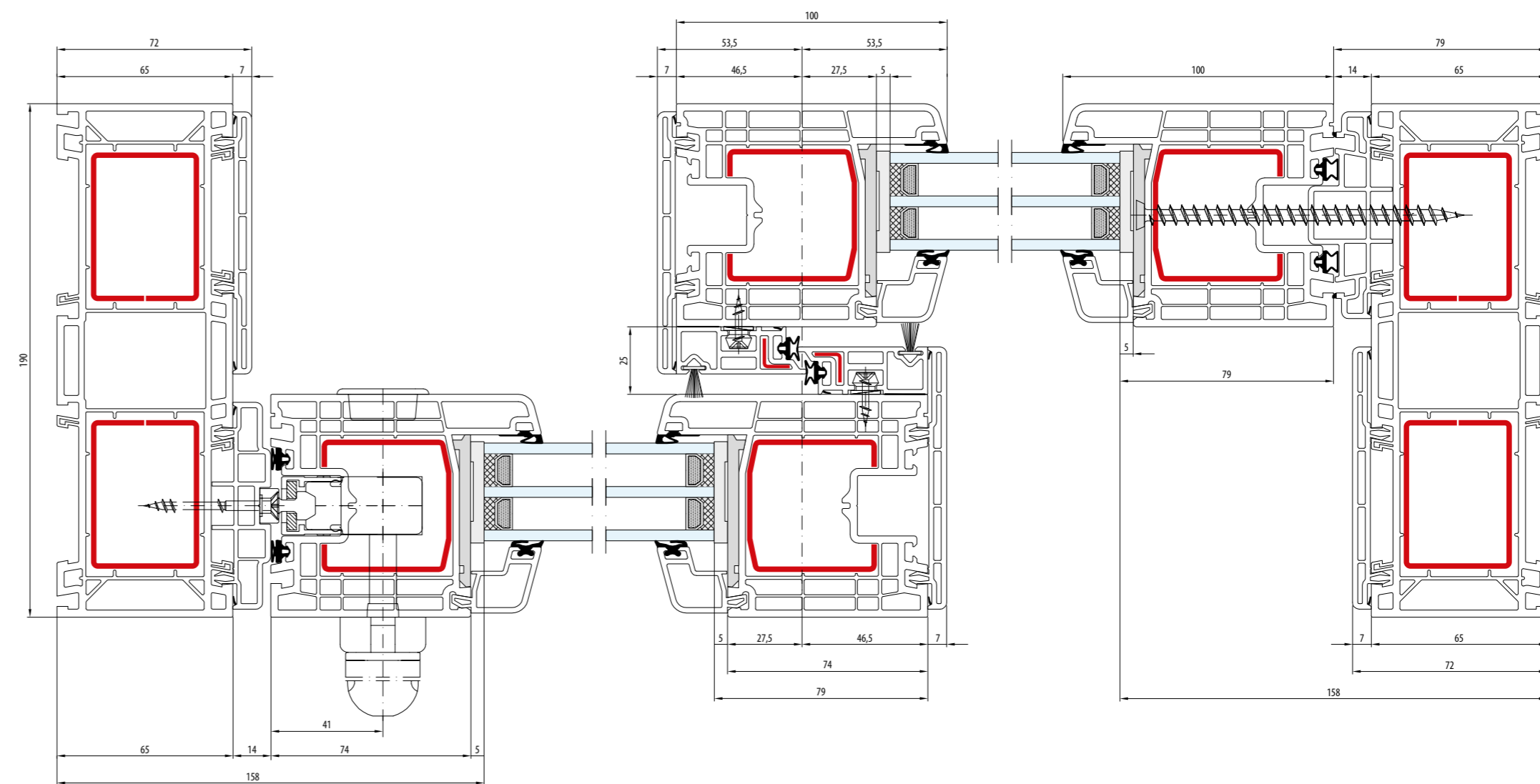

- Schemat A - Przekrój poziomy - Rama: 65 mm · Skrzydło: 100 mm
- Schéma A - Coupe horizontale - Dormant: 65 mm · Vantail: 100 mm
- Schema A - Doorsnede horizontaal - Frame: 65 mm · Sash: 100 mm
- Schema A - Wagerechter Schnitt - Rahmen: 65 mm · Flügel: 100 mm
- Schema A - Sezione orizzontale - Telaio: 65 mm · Anta: 100 mm

1:2

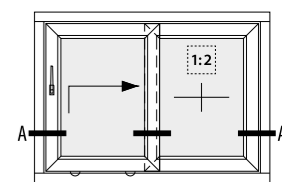

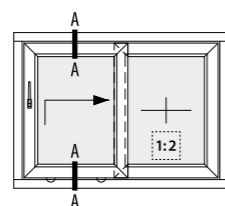
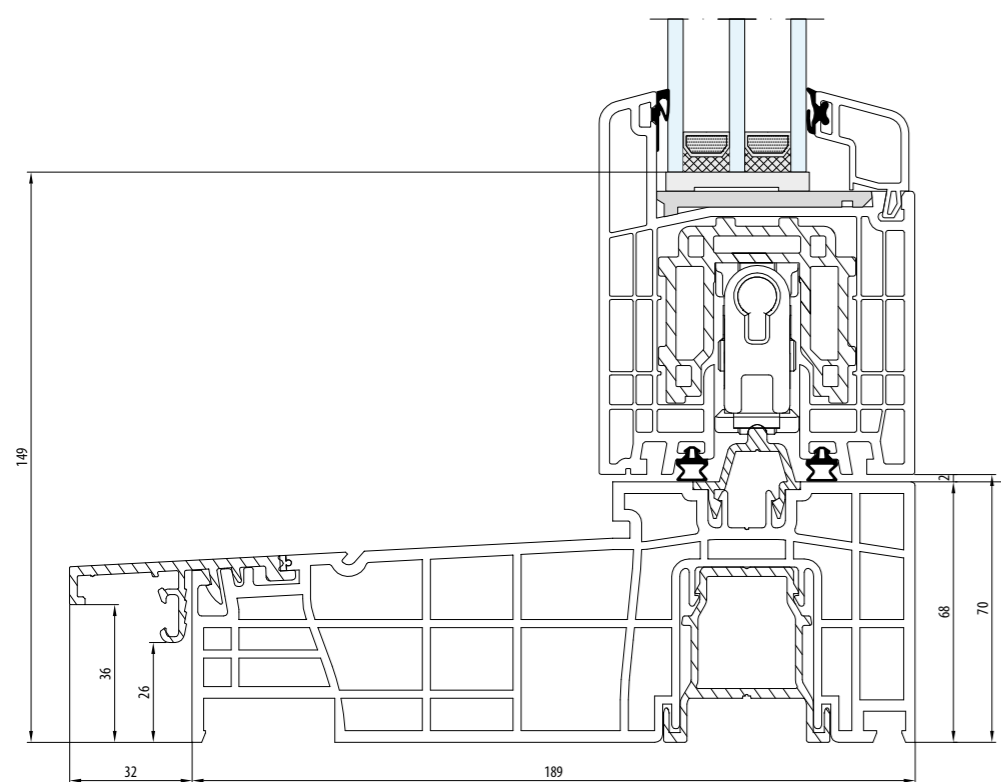
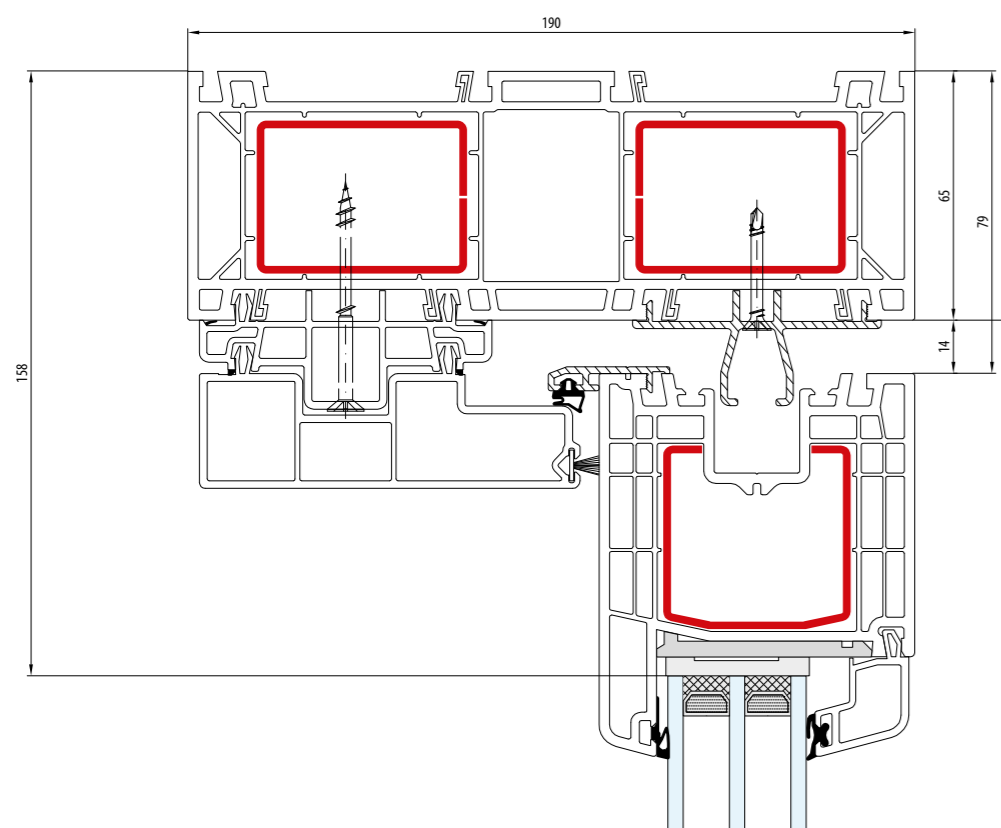

- Schemat A - Przekrój pionowy · Próg: 68 mm · Skrzydło: 100 mm
- Schéma A - Coupe verticale · Seuil: 68 mm · Vantail: 100 mm
- Schema A - Doorsnede verticaal · Doorstep: 68 mm · Sash: 100 mm
- Schema A - Senkrechter Schnitt · Schwelle: 68 mm · Flügel: 100 mm
- Schema A - Sezione verticale · Soglia: 68 mm · Anta: 100 mm

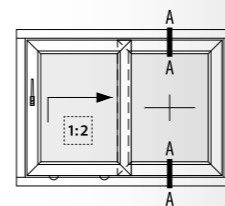
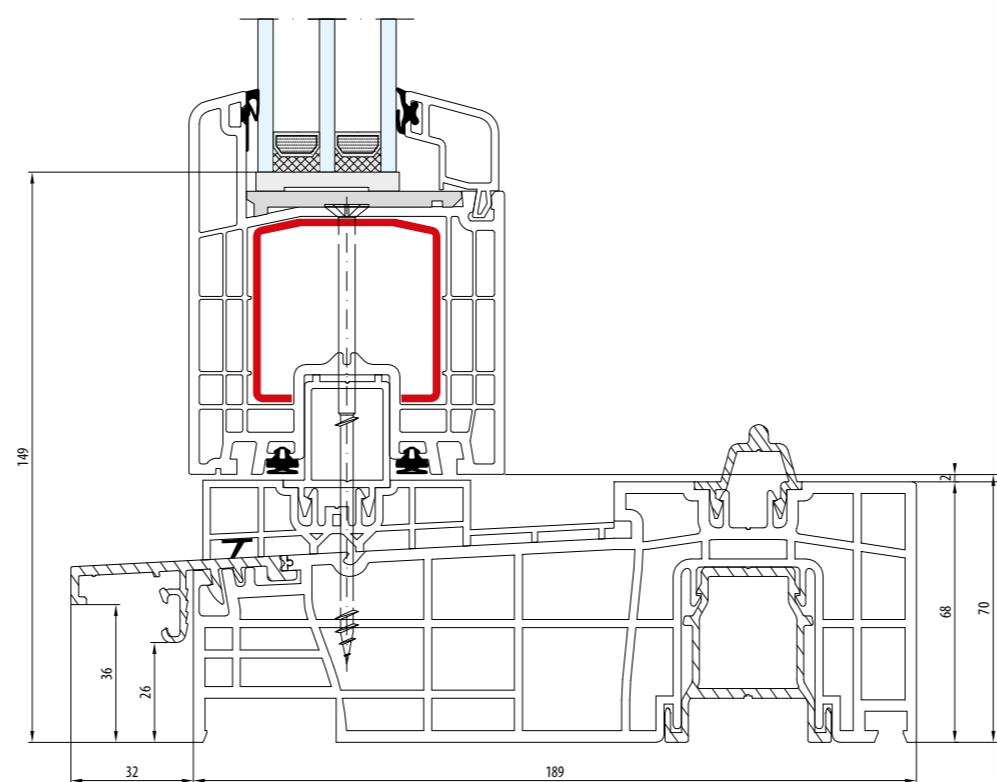
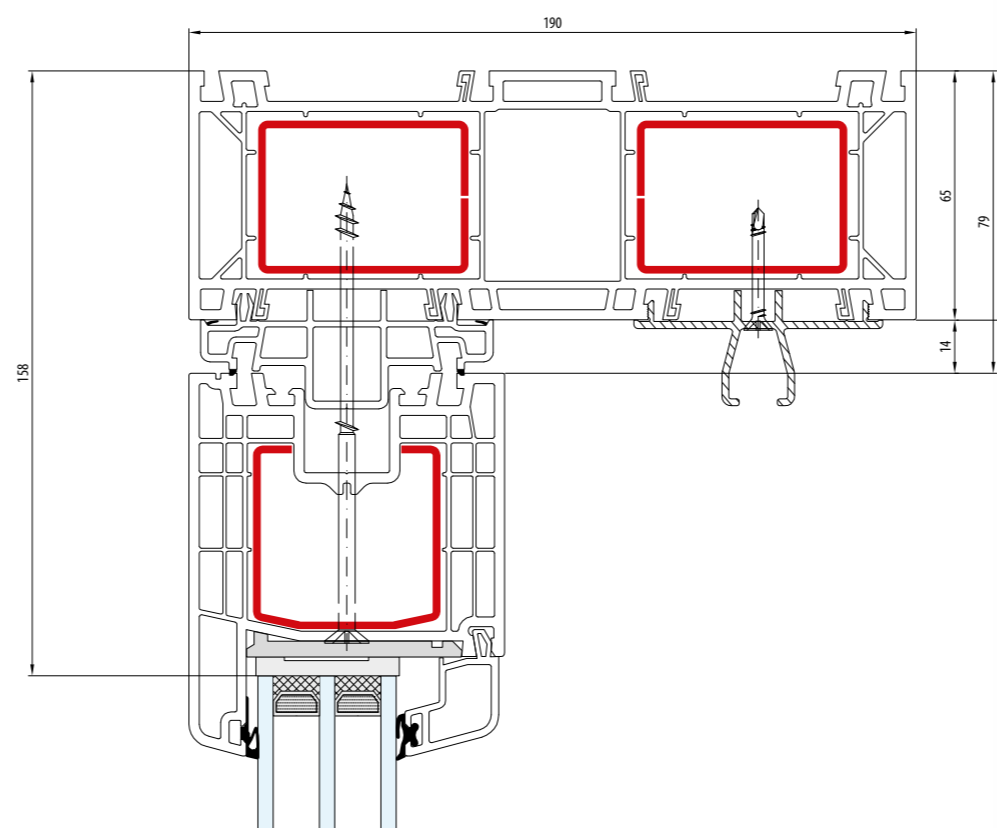

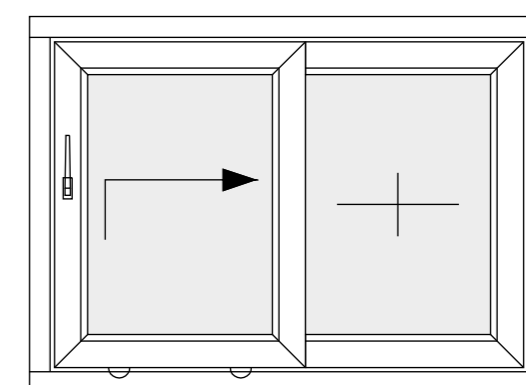

- Schemat A - Przekrój pionowy · Próg: 68 mm · Skrzydło: 100 mm
- Schéma A - Coupe verticale · Seuil: 68 mm · Vantail: 100 mm
- Schema A - Doorsnede verticaal · Doorstep: 68 mm · Sash: 100 mm
- Schema A - Senkrechter Schnitt · Schwelle: 68 mm · Flügel: 100 mm
- Schema A - Sezione verticale · Soglia: 68 mm · Anta: 100 mm

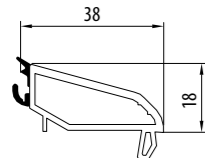
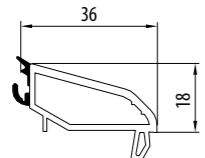
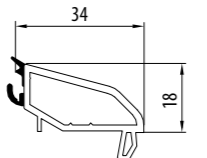
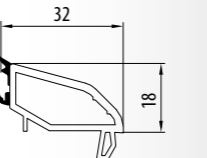
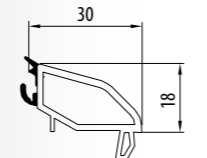
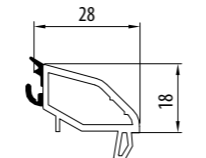
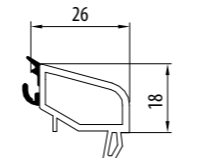
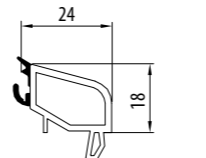
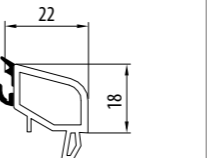
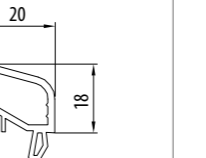
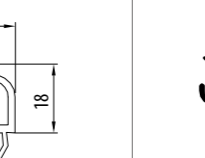
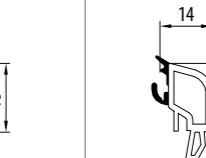
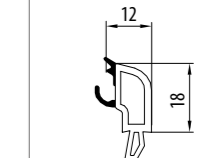
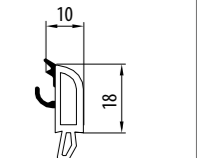
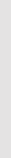

A

- Schemat
- Schéma
- Schema
- Schema
- Schema

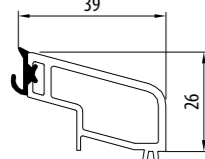
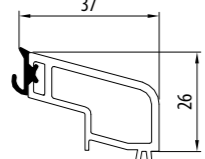
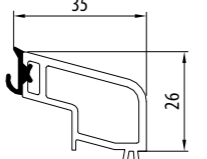
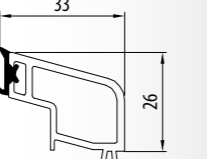
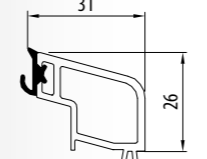
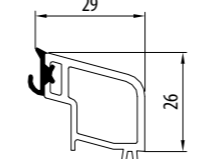
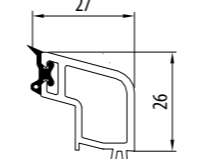
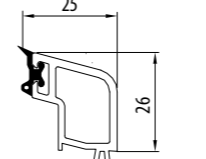
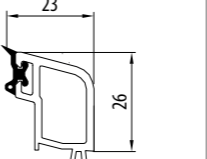
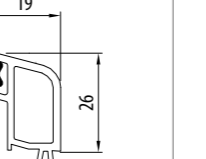
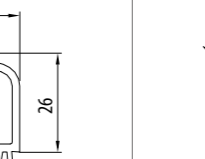
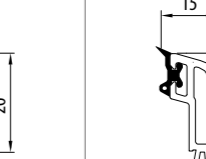
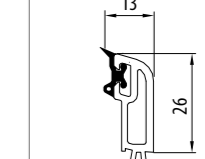
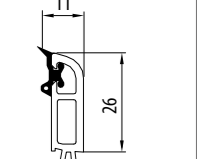
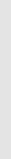
d [mm]					d [mm]										
S 9000	23 - 24 STV 26 - 27	25 - 26 STV 28 - 29	27 - 28 STV 30 - 31	29 - 30 STV 32 - 33	31 - 32 STV 34 - 35	33 - 34 STV 36 - 37	35 - 36 STV 38 - 39	37 - 38 STV 40 - 41	39 - 40 STV 42 - 43	41 - 42 STV 44 - 45	43 - 44 STV 46 - 47	45 - 46 STV 48 - 49	47 - 48 STV 50 - 51	49 - 50 STV 52 - 53	52 - 53 STV 54
															
7194	7196	7122	7134	7156	7131	7130	7142	7164	7116	7138	7180	7162	7144	7146	
S 9000 HST Gealan	23 - 24 STV 26 - 27	25 - 26 STV 28 - 29	27 - 28 STV 30 - 31	29 - 30 STV 32 - 33	31 - 32 STV 34 - 35	33 - 34 STV 36 - 37	35 - 36 STV 38 - 39	37 - 38 STV 40 - 41	39 - 40 STV 42 - 43	41 - 42 STV 44 - 45	43 - 44 STV 46 - 47	45 - 46 STV 48 - 49	47 - 48 STV 50 - 51	49 - 50 STV 52 - 53	51 - 52 STV 54
															
6124	6126	6128	6130	6132	6134	6136	6138	6140	6142	6144	6146	6148	6150	6152	

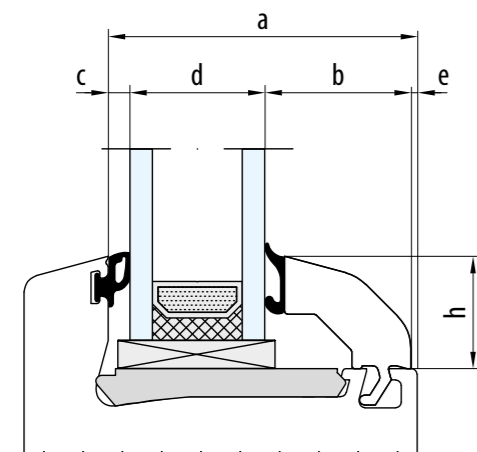

$b = a - c - d - e$

	a [mm]	c [mm]	e [mm]
S 9000 HST Gealan	67,5	4	1,5



3284

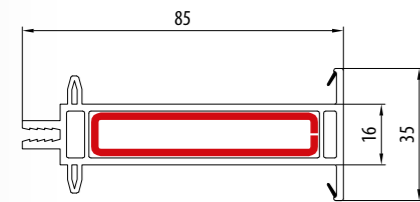

6281

2.0 | 674251 | lx 0,5 | ly 9,1

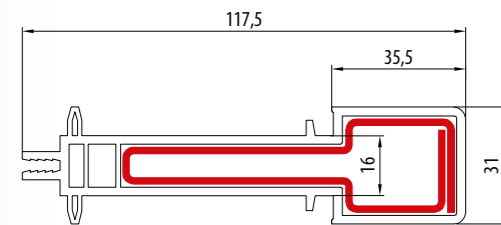

5204

2.0 | 771051 | lx 2,2 | ly 36,1

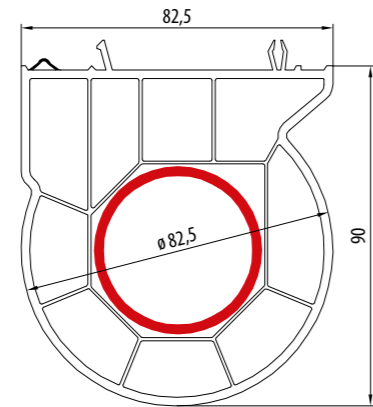

5206

2.5 | 771151 | lx 7,5 | ly 7,5

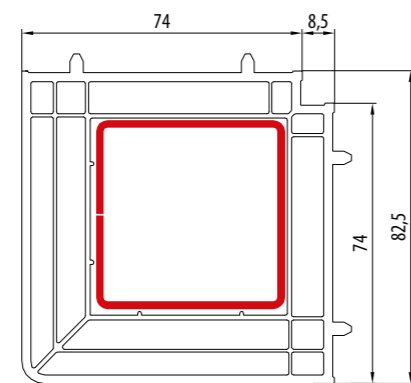

2304

2.0 | 771851 | lx 14,3 | ly 14,3

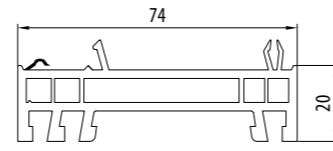

2315

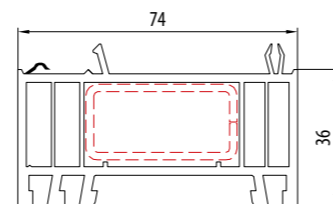

2313

- 0,0 - | lx 0,0 | ly 0,0

2.0 | 272451 | lx 1,3 | ly 4,1

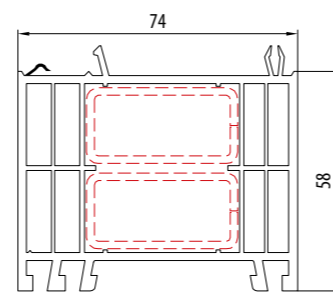

7292

- 0,0 - | lx 0,0 | ly 0,0

2.0 | 272451 x 2 | lx 2,7 | ly 8,3

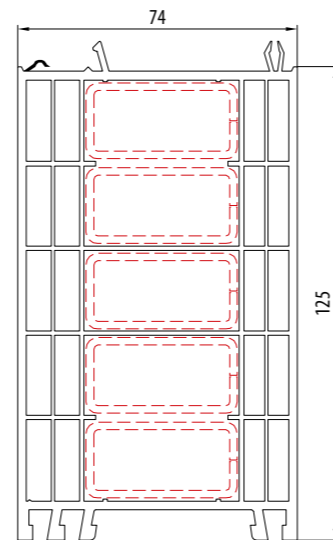

2311

- 0,0 - | lx 0,0 | ly 0,0

2.0 | 272451 x 4 | lx 5,5 | ly 16,6

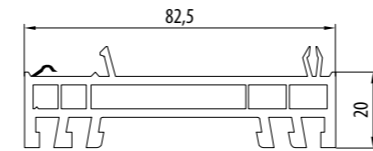

5201

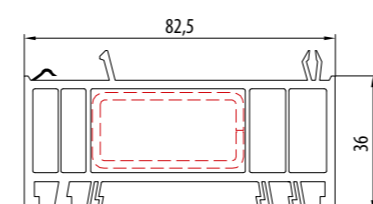

5213

- 0,0 - | lx 0,0 | ly 0,0

2.0 | 272451 | lx 1,3 | ly 4,1

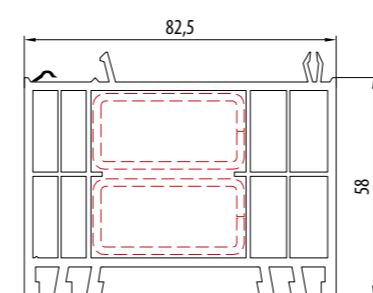

5202

- 0,0 - | lx 0,0 | ly 0,0

2.0 | 272451 x 2 | lx 2,7 | ly 8,3

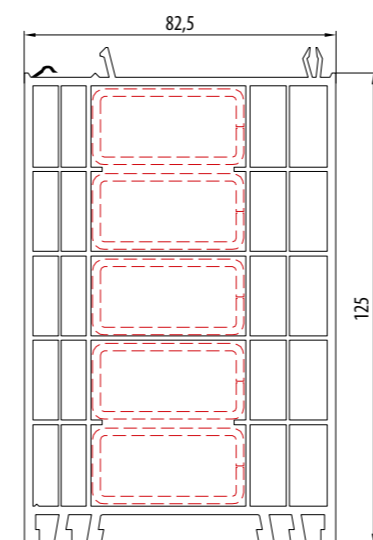

5203

- 0,0 - | lx 0,0 | ly 0,0

2.0 | 272451 x 4 | lx 5,5 | ly 16,6

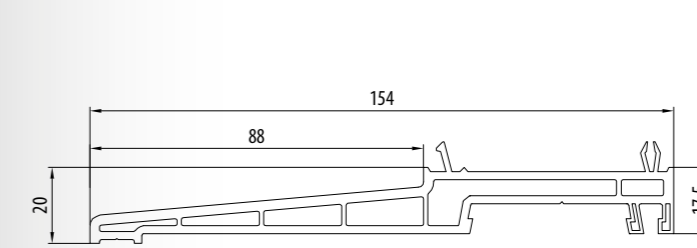

2203

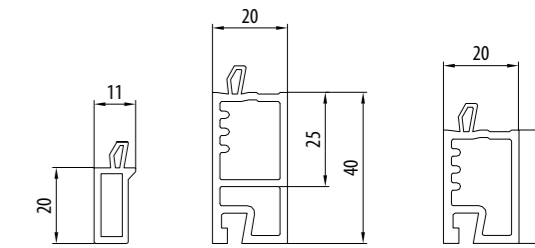

2101

3205

3206

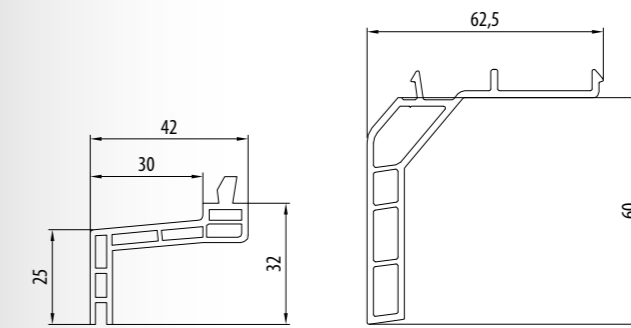

2209

7209

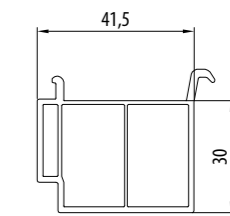

7202

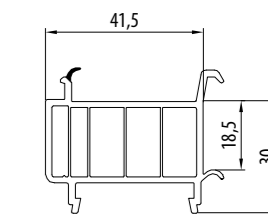

7205

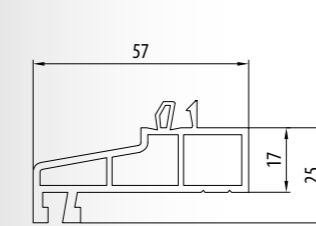

3207

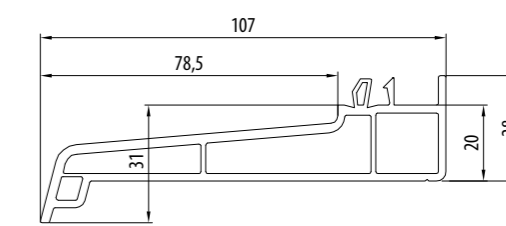

7213

GEALAN

S 9000

OKO OKNA



Publikacja nie stanowi oferty handlowej. Nie jest podstawą do składania reklamacji.
Zaprezentowane fotografie są zdjęciami poglądowymi, a nie rzeczywistymi zdjęciami produktów.



La publication ne constitue pas une offre commerciale. Ce n'est pas une base pour déposer des plaintes.
Les photographies présentées sont des images illustratives, pas des photos de produits réels.



The publication does not constitute a commercial offer. It is not a basis for submitting complaints.
Presented photographs are illustrative pictures, not actual product photos.



Dieser Katalog ist kein kommerzielles Angebot. Es ist auch keine Grundlage für die Einreichung von Reklamationen.
Die präsentierten Fotos sind Beispielbilder, keine tatsächlichen Produktfotos.



La pubblicazione non costituisce un'offerta commerciale. Non può essere la base per la presentazione di reclami.
Le fotografie hanno carattere illustrativo e non sono foto di prodotti reali.

1/2020



Eko-Okna S.A.

Spacerowa 4

47-480 Kornice